

Features

- High efficiency over 91% at 230 VAC
- Universal AC input voltage range: 90-264 VAC
- Active power factor correction
- Over temperature, output overvoltage, overcurrent and short circuit protection
- Low conducted and radiated EMI (EN 55022 cl. A)
- Safety approval to UL/CSA/EN/IEC60950-1
- High power density design: 15 W/in³
- Compact size: 2.0 (W) x 4.0 (L) x 1.5 (H) inches
- ROHS compliant

Applications

- Telecom, datacom, industrial equipment.

Description

This is a family of compact and efficient AC-DC power supplies suited for telecom datacom and many other industrial applications. This family meets the international information technology safety standards with the CE-Mark for the European Low Voltage Directive (LVD). Their high efficiency allows a very minimal power loss in end equipment, resulting in higher reliability, ease of thermal management and regulatory approvals for an environmentally friendly end product.

Content

1 ORDERING INFORMATION.....	2	7 PROTECTION.....	8
2 OVERVIEW.....	2	7.1 OVERVOLTAGE PROTECTION	8
3 ABSOLUTE MAXIMUM RATINGS.....	3	7.2 CURRENT LIMITATION	8
4 ENVIRONMENTAL AND MECHANICAL	3	8 POWER GOOD SIGNAL	9
5 INPUT SPECIFICATIONS	3	9 ELECTROMAGNETIC COMPATIBILITY	9
5.1 INPUT FUSE	4	9.1 IMMUNITY	9
5.2 INRUSH CURRENT	4	9.2 EMISSION	9
5.3 INPUT UNDER-VOLTAGE	4	10 SAFETY / APPROVALS.....	10
5.4 POWER FACTOR CORRECTION	4	11 MECHANICAL	11
5.5 EFFICIENCY	4	11.1 DIMENSIONS.....	11
6 OUTPUT SPECIFICATIONS	6	11.2 CONNECTIONS	12

1 ORDERING INFORMATION

Product Family	Power Level	Dash	# Outputs	Standard: 0	Vo-Voltage	RoHS compliant
ABC	200	-	1	0	12	G
					24	
					48	

2 OVERVIEW

The ABC200-10XXG is a high efficiency and high power density AC to DC power supply. It incorporates boundary conduction mode (BCM) PFC converter and soft-switching LLC converter, providing increased system reliability and high efficiency.

With 1 m/s system air cooling, the ABC200-1012G can deliver up to 180 W continuous output power, and 204W for ABC200-1024G and the ABC200-1048G.

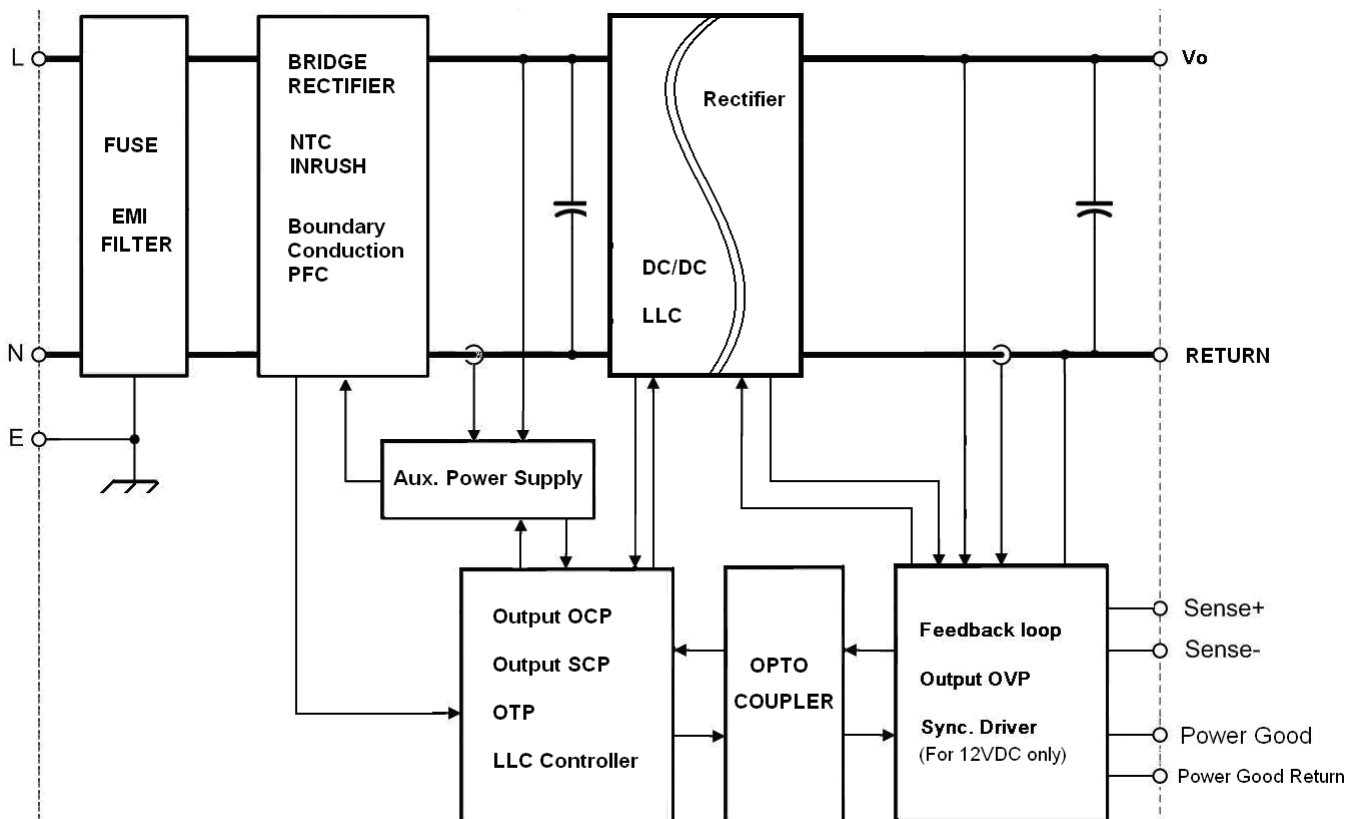

Figure 1: ABC200-10XXG block diagram

3 ABSOLUTE MAXIMUM RATINGS

Stresses in excess of the absolute maximum ratings may cause performance degradation, adversely affect long-term reliability, and cause permanent damage to the supply.

Parameter		Conditions / Description	Min	Nom	Max	Unit
$V_{i\maxc}$	Max continuous input	Continuous			264	VAC
		Transient, 60 ms			300	VAC

4 ENVIRONMENTAL AND MECHANICAL

Parameter		Conditions / Description	Min	Nom	Max	Unit
T_A	Ambient temperature	$V_{i\min}$ to $V_{i\max}$, $I_{1\text{ nom}}$, $I_{SB\text{ nom}}$	-10		+50	°C
$T_{A\text{ext}}$	Extended temp range	Derated output	+50		+70	°C
T_S	Storage temperature	Non-operational	-40		+85	°C
	Dimensions	Width		50.8		mm
		Height		36.6		mm
		Depth		101.6		mm
M	Weight			0.2		kg

5 INPUT SPECIFICATIONS

General Condition: $T_A = -10$ to 50°C unless otherwise noted.

Active fan air cooling required: 200 LFM (1 m/s)

Parameter		Conditions / Description	Min	Nom	Max	Unit
$V_{i\text{ nom}}$	Nominal input voltage		100		240	VAC
V_i	Input voltage ranges	Normal operating ($V_{i\min}$ to $V_{i\max}$)	90		264	VAC
$I_{i\max}$	Max input current	At 90 VAC input and max rating		2.75		A_{rms}
$I_{i\text{ p}}$	Inrush current limitation	$V_{i\text{ nom}}=115\text{VAC}$, $T=25^\circ\text{C}$ (see Figure)			40	A_{p}
		$V_{i\text{ nom}}=230\text{VAC}$, $T=25^\circ\text{C}$ (see Figure 4)			80	
F_i	Input frequency		47	50/60	63	Hz
PF	Power factor	Normal input, half load and above	0.9			
$V_{i\text{ on}}$	Turn-on input voltage ¹⁾	Ramping up	85	87	90	VAC
$V_{i\text{ off}}$	Turn-off input voltage ¹⁾	Ramping down	80	83	85	VAC
η	Efficiency	$V_{i\text{ nom}}=230\text{VAC}$, $0.5 \cdot I_{x\text{ nom}}$, $V_{x\text{ nom}}$, $T_A = 25^\circ\text{C}$		89		%
		$V_{i\text{ nom}}=230\text{VAC}$, $1.0 \cdot I_{x\text{ nom}}$, $V_{x\text{ nom}}$, $T_A = 25^\circ\text{C}$		91		
T_{hold}	Hold-up Time	After last AC zero point, V_O within regulation, $V_i = 115\text{ VAC}$, $P_{x\text{ nom}}$	10			ms

¹⁾ The power supply is provided with the hysteresis loop (about 4.5V) during turn-on and turn-off within the ranges.

5.1 INPUT FUSE

A slow-blow 5A input fuse (5 × 20 mm) in series with live line inside the power supply protects against severe defects. The fuse and a VDR form together with the input filter an effective protection against high input transients.

5.2 INRUSH CURRENT

The AC-DC power supply exhibits an X-capacitance of only about 1.0 μF, resulting in a low and short peak current, when the supply is connected to the mains. The internal bulk capacitor will be charged through a NTC resistor which will limit the inrush current (see Figure 2 and 3).

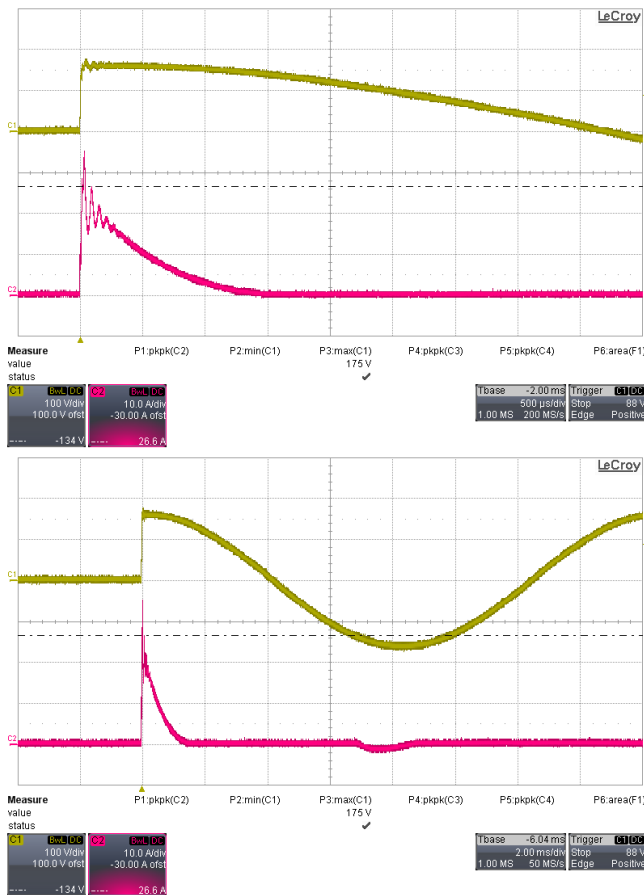

Figure 2: Inrush current, $V_{in} = 115\text{Vac}$, 90°
CH1: V_{in} (100V/div), CH2: I_{in} (10A/div),

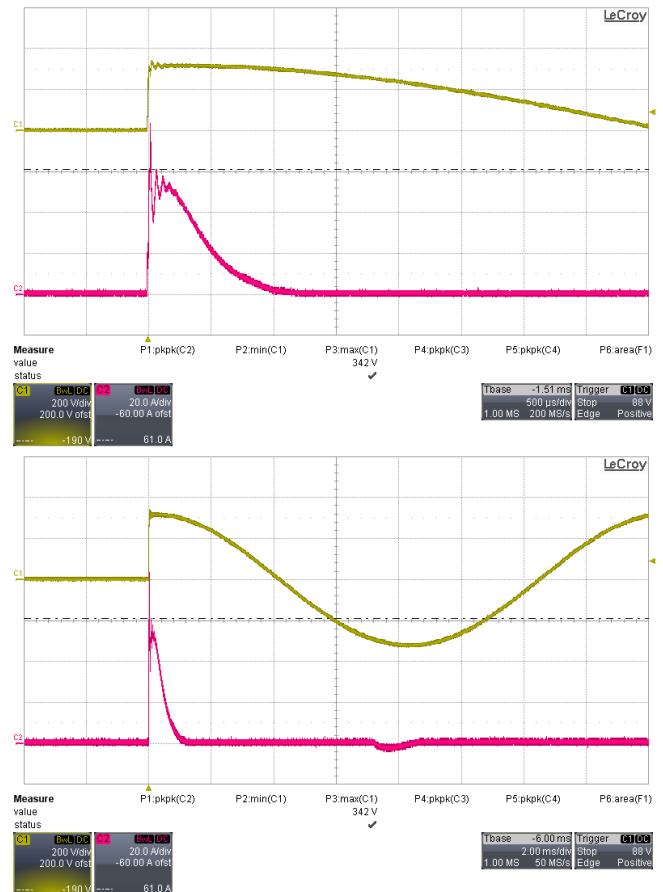

Figure 3: Inrush current, $V_{in} = 230\text{Vac}$, 90°
CH1: V_{in} (200V/div), CH2: I_{in} (20A/div)

5.3 INPUT UNDER-VOLTAGE

If the sinusoidal input voltage stays below the input under voltage lockout threshold $V_{i\text{on}}$, the supply will be inhibited. Once the input voltage returns within the normal operating range, the supply will return to normal operation again.

5.4 POWER FACTOR CORRECTION

Power factor correction (PFC) is achieved by controlling the input current waveform synchronously with the input voltage. A specified PFC controller is implemented in the boundary conduction mode topology giving outstanding PFC results over a wide input voltage and load ranges. The input current will follow the shape of the input voltage.

5.5 EFFICIENCY

The high efficiency (see Figure 4) is achieved by using soft-switching LLC technology with boundary conduction mode PFC topology minimizing switching losses. Synchronous

rectifiers on the output reduce the losses in the high current output path for ABC200-1012G.

A Schottky or ultra fast diode is used as the rectifier in the ABC200-1024G and ABC200-1048G because of the high output voltage level.

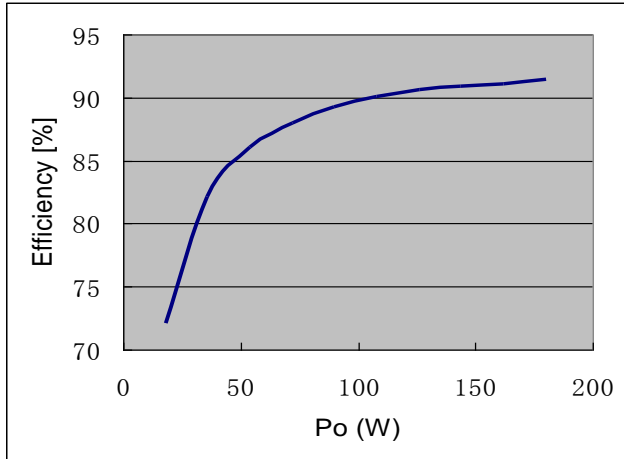

Efficiency vs. Output Power at 230VAC, ABC200-1012G

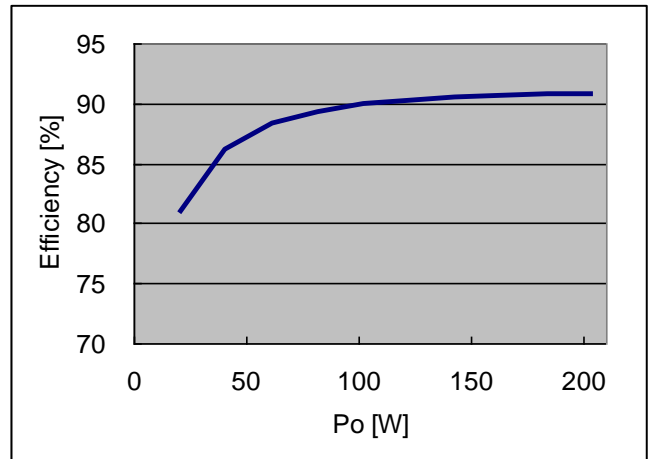

Efficiency vs. Output Power at 230VAC, ABC200-1024G

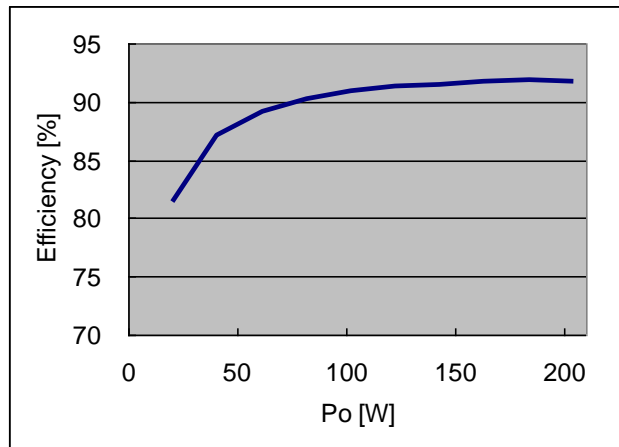

Efficiency vs. Output Power at 230VAC, ABC200-1048G

Figure 4. Efficiency Curves

6 OUTPUT SPECIFICATIONS

General Condition: $T_A = -10$ to $+50^\circ\text{C}$ unless otherwise noted. Derate linearly from 50°C to 50% at 70°C .

Active fan air cooling required: 200 LFM (1 m/s)

Parameter	Conditions / Description		Min	Nom	Max	Unit	
Main Output V_O							
V_O	Nominal output voltage	$0.5 \cdot I_O, T_{amb} = 25^\circ\text{C}$	ABC200-1012G		12.0		VDC
			ABC200-1024G		24.0		
			ABC200-1048G		48.0		
$V_{O\ set}$	Output setpoint accuracy	$0.5 \cdot I_O, T_{amb} = 25^\circ\text{C}$	ABC200-1012G	11.95		12.05	VDC
			ABC200-1024G	23.90		24.10	
			ABC200-1048G	47.80		48.20	
P_O	Nominal output power		ABC200-1012G		180		W
			ABC200-1024G		204		W
			ABC200-1048G		204		W
I_O	Nominal output current		ABC200-1012G		13	15	ADC
			ABC200-1024G		7.5	8.5	ADC
			ABC200-1048G		3.5	4.25	ADC
$V_{O\ ripple}$	Output ripple & noise	$V_{O\ nom}, I_{O\ nom}, 20\ \text{MHz BW}$	ABC200-1012G			120	mV
			ABC200-1024G			240	mV
			ABC200-1048G			480	mV
dV_O	Load regulation	$V_i = V_{i\ nom}, 0 - 100\% I_{O\ nom}$	ABC200-1012G		60	120	mV
			ABC200-1024G		120	240	mV
			ABC200-1048G		240	480	mV
$dV_{i\ Line}$	Line regulation	$V_i = V_{i\ min} \dots V_{i\ max}$	ABC200-1012G		12	120	mV
			ABC200-1024G		24	240	mV
			ABC200-1048G		96	480	mV
dV_{dyn}	Dynamic load regulation	$\Delta I_O = 50\% I_{O\ nom}, I_O = 50 \dots 100\% I_{O\ max}, dI_O/dt = 1\ \text{A}/\mu\text{s}, \text{recovery within } 5\% \text{ of } V_{O\ nom}$	ABC200-1012G			0.6	VDC
			ABC200-1024G			1.2	VDC
			ABC200-1048G			2.4	VDC
			ABC200-10XXG			2	ms
T_{rec}	Recovery time						
t_{Delay}	Turn on delay time	See Figure 5 and Figure 6	0	1.5	2.5	sec	
t_{rise}	Rise time	$V_O = 10 \dots 90\% V_{O\ nom}$ (see Figure 10)			20	ms	
		Note: For ABC200-1048G, maximum rise time is 30ms					
C_{Load}	Capacitive loading	$T_{amb} = 25^\circ\text{C}$	ABC200-1012G			3300	μF
			ABC200-1024G			1800	μF
			ABC200-1048G			1000	μF

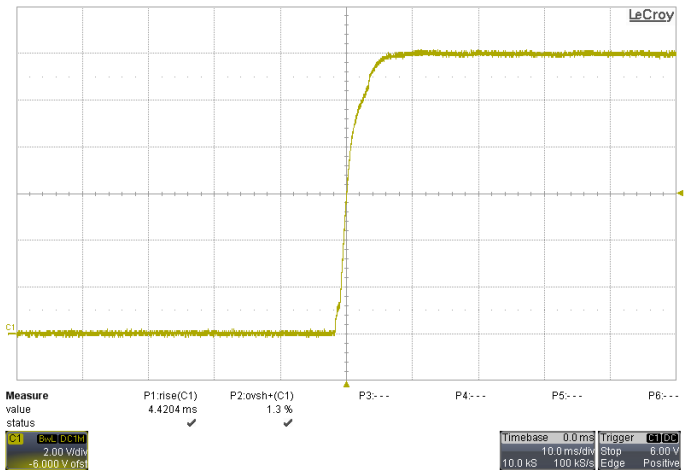
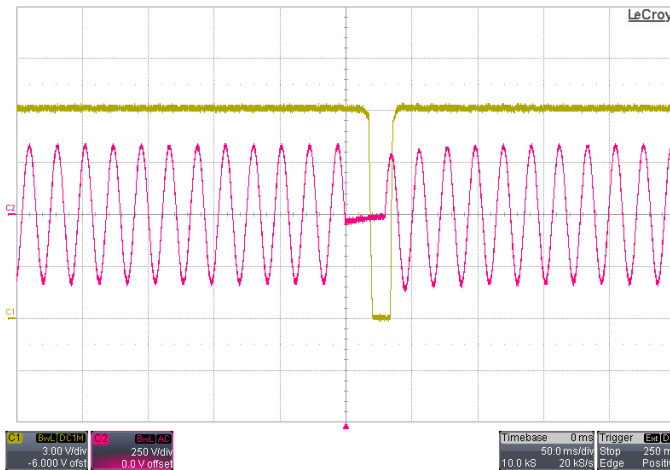
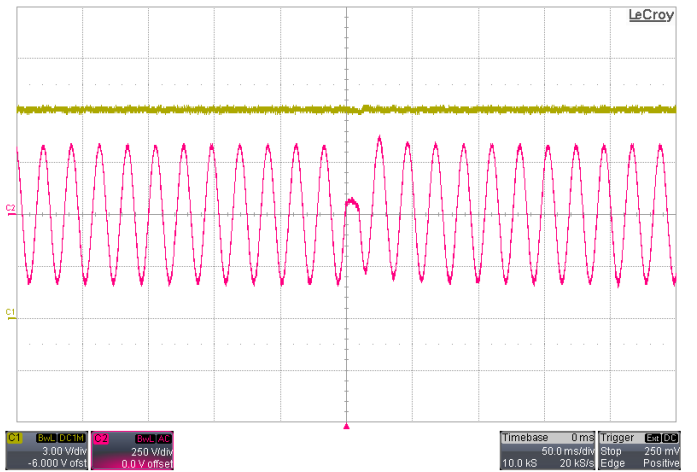
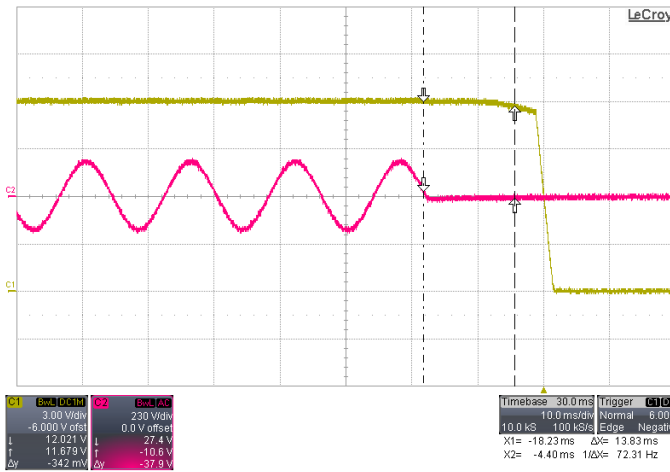
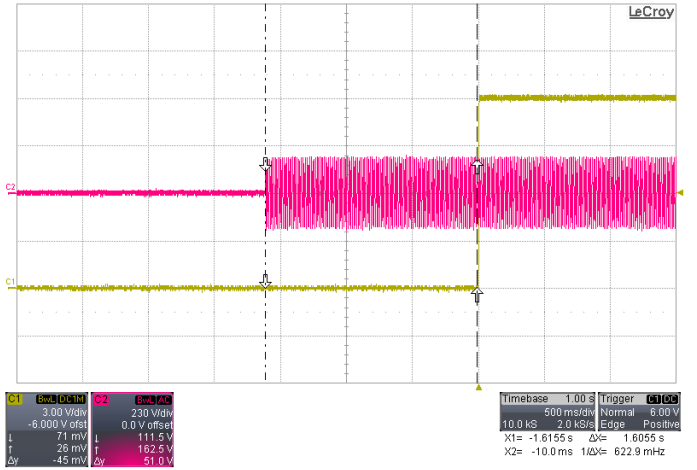
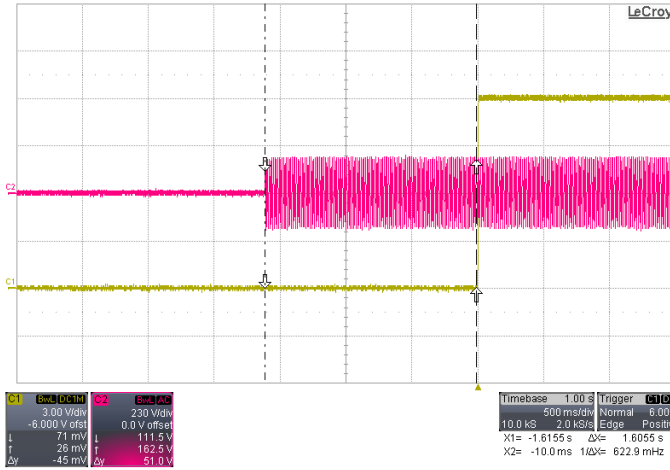

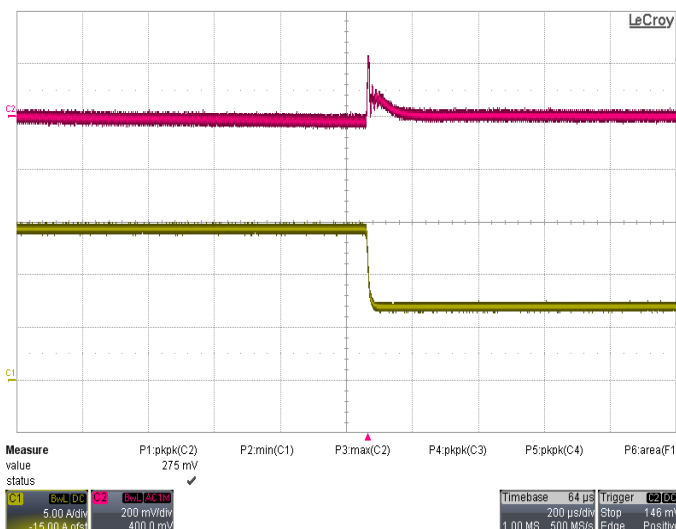
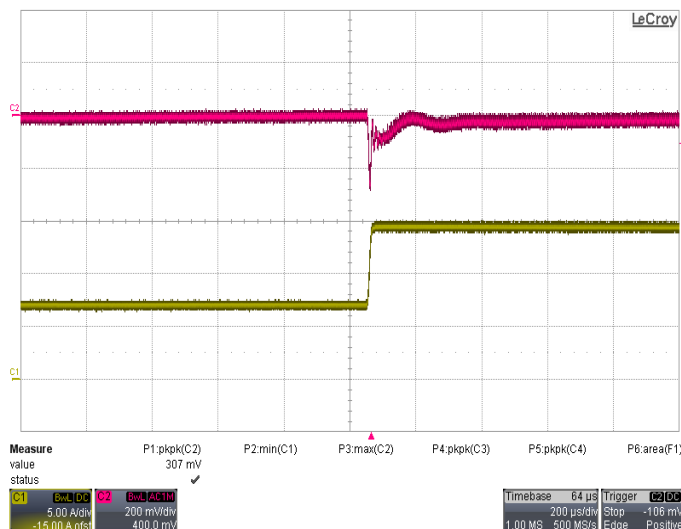

7 PROTECTION

Parameter	Conditions / Description		Min	Nom	Max	Unit
I_{FUSE}	Input fuses rating	Not user accessible, time lag characteristic		5.0		A
$V_{O\,OV}$	OV trigger point	ABC200-1012G	14.0	15.0	16.0	VDC
		ABC200-1024G	28.0	30.0	32.0	VDC
		ABC200-1048G	53.0	55.0	57.0	VDC
$I_{O\,lim}$	Current limit	$V_i > 90\text{ VAC}$, $-10\text{ }^\circ\text{C} < T_a < 50\text{ }^\circ\text{C}$		18.0		A
		ABC200-1024G		9.0		A
		ABC200-1048G		4.5		A
T_{SD}	Temperature on heat sinks	Automatic shut-down, automatic recovery after cool down.		105		$^\circ\text{C}$

7.1 OVERVOLTAGE PROTECTION

The AC-DC power supply provides a fixed threshold overvoltage (OV) protection implemented with a HW comparator. Once an OV condition has been triggered, the supply will shut down and latch the fault condition. The latch can be unlocked by disconnecting the supply from the AC mains only.

7.2 CURRENT LIMITATION

The main output current limitation will decrease with linear derating to 50% at 70 $^\circ\text{C}$ if the ambient (inlet) temperature increases beyond 50 $^\circ\text{C}$ (see Figure 13).

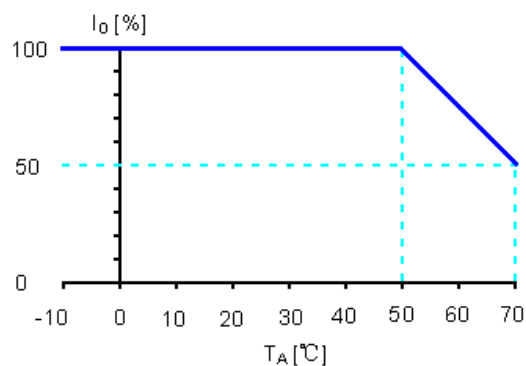
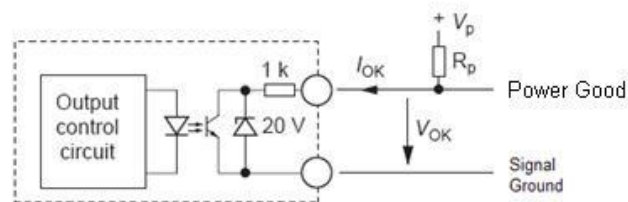

Figure 13: Output Current Capacity Derating

8 POWER GOOD SIGNAL

The Out-OK output gives a status indication of the converter and the output voltages. It can be used for control functions such as data protection, central system monitoring or as a part of a self-testing system. Connecting the Out-OK as shown in Figure 14, $V_{OK} < 1.0\text{ V}$ indicates the output voltage(s) of the converter are within the range.

Note: Using the potentiometer, the monitor level tracks the programmed output voltage. In an error condition, if the output voltage is out of range due to overload or an external over voltage, V_{OK} will approach V_p . The output is formed by an NPN transistor. The signal is isolated from the output.



O/P V OK - Signal Low, Opto conducting, (max sink current 0.5 mA)
O/P V Bad - Signal High, Opto open, (max leakage current 25 μA)

Figure 14: Power Good signal

9 ELECTROMAGNETIC COMPATIBILITY

9.1 IMMUNITY

Note: Most of the immunity requirements are derived from EN 55024:1998/A2:2003.

Test	Standard / Description	Criteria
ESD Contact Discharge	EN 61000-4-2, Level 2	A
RF Susceptibility	EN 61000-4-3, Level 3	A
Fast Transient/Burst	EN 61000-4-4, Level 3	B
Surge	EN 61000-4-5, Class 3	B
RF Conducted Immunity	EN 61000-4-6, Class 3	A
Voltage Dips and Interruptions	EN 61000-4-11	C
Magnetic Fields	EN 61000-4-8, Level 3	A

9.2 EMISSION

Test	Standard / Description	Criteria
Conducted Emission	EN55022 / CISPR 22: 0.15 ... 30 MHz, QP and AVG, single unit	Class A
Radiated Emission	EN55022 / CISPR 22: 30 MHz ... 1 GHz, QP, single unit	Class A
Harmonic Emissions	IEC61000-3-2, $V_{in} = 100\text{ VAC}/60\text{ Hz}, 100\% \text{ Load}$	Class A
	IEC61000-3-2, $V_{in} = 240\text{ VAC}/50\text{ Hz}, 100\% \text{ Load}$	Class A
Voltage Fluctuation and Flicker	EN61000-3-3	PASS

10 SAFETY / APPROVALS

Maximum electric strength testing is performed in the factory according to IEC/EN 60950, and UL 60950. Input-to-output electric strength tests should not be repeated in the field. Power-One will not honor any warranty claims resulting from electric strength field tests.

Parameter	Description / Conditions	Min	Nom	Max	Unit
Agency Approvals	UL 60950-1 Second Edition CSA-C22.2 No. 60950-1-03 Second Edition IEC 60950-1:2005 EN 60950-1:2006 CE Mark for LVD CB Approval	Approved by independent body (see CE Declaration)			
Insulation Safety Rating	Input / Case	Basic			
	Input / Output	Reinforced			
	Output / Case	Functional			
Creepage / clearance	Primary (L/N) to protective earth (PE)	According to safety standard			mm
	Primary to secondary				mm
Electrical strength test	Input to case	2.121			kVDC
	Input to output	4.2			kVDC
	Output and Signals to case	500			VDC

11 MECHANICAL

11.1 DIMENSIONS

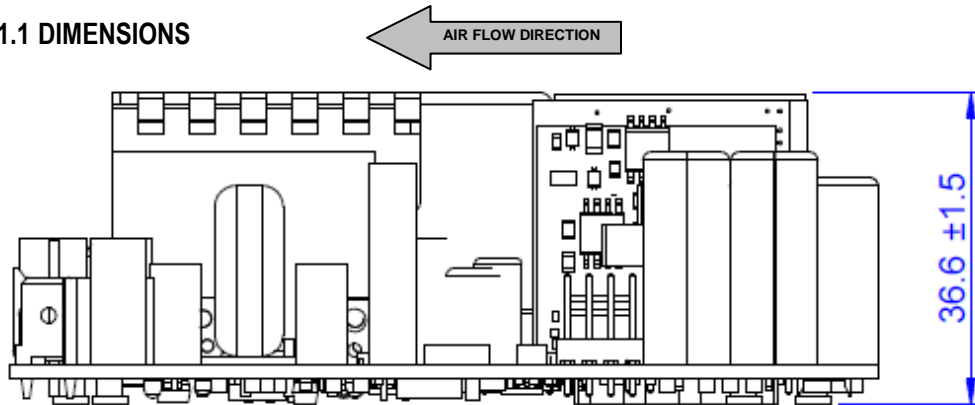
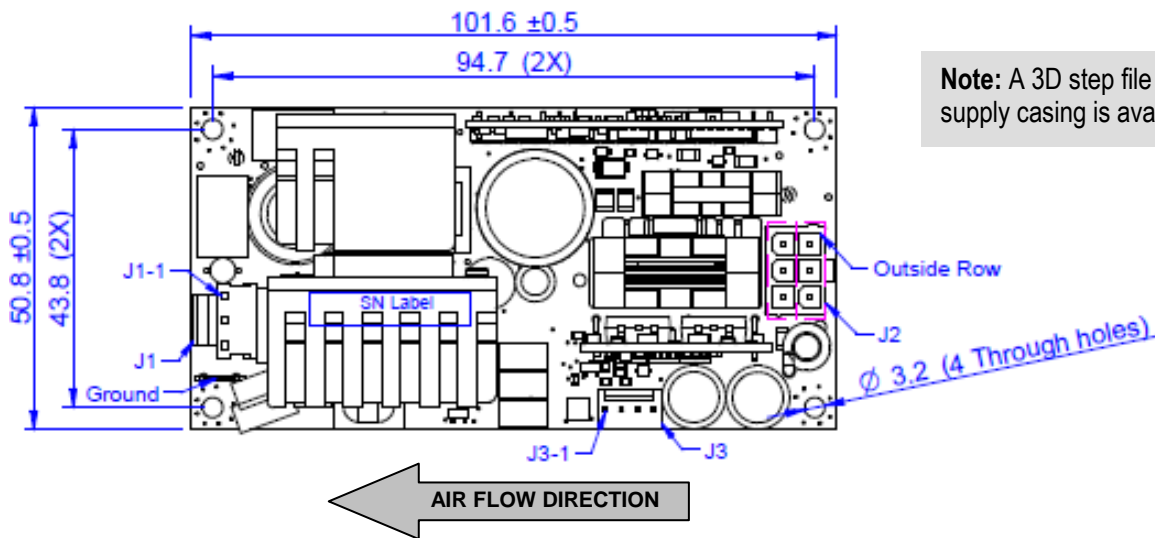

Figure 15: Side view 1



Note: A 3D step file of the power supply casing is available on request.

Figure 16: Top view

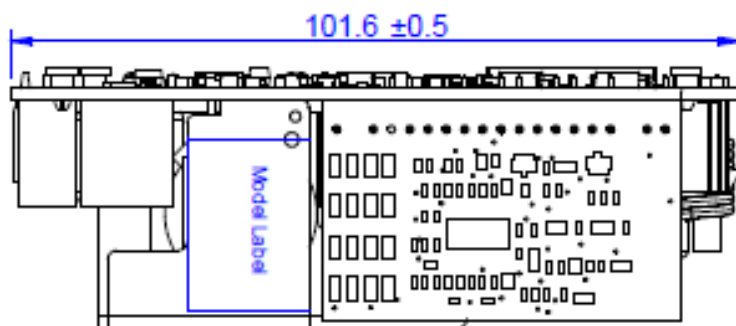

Figure 17: Side view 2

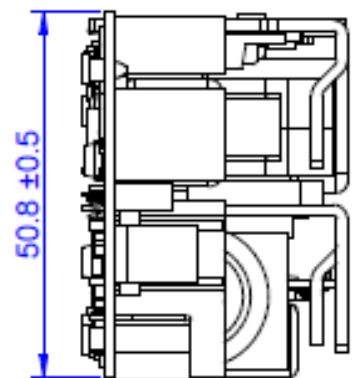

Figure 28: Front view

Note: pictures for mechanical dimension were taken from ABC200-1012G.

11.2 CONNECTIONS

Pin	Name	Description
Input J1		
J1-1	Live	AC Input Live
J1-2	NA	NA
J1-3	Neutral	AC Input Neutral
Output J2		
Pin 1-3(Insider Row)	-Vo	+12V / +24V / +48V output return
Pin 4-6(Outside Row)	+Vo	+12V / +24V / +48V output
Signal J3		
J3-1	Power Good RTN	Power OK signal output return
J3-2	Power Good	Power OK signal output
J3-3	Vo Sense +	Main output positive sense
J3-4	Vo Sense -	Main output negative sense

Connector Mating Parts(Molex or equivalent):

CONNECTOR	HOUSING	CRIMP TERMINAL	WIRE GAUGE
J1	09-50-3031	08-50-0105	AWG # 18
J2	39-01-2065	44476-3112	AWG # 16
J3	22-01-3047	08-50-0113	AWG #22-30
Ground		01-90020001	AWG#18

Copyright © 2010 Power-One Inc. All rights reserved. Words and logos that are identified as trademarks and/or service marks are, unless noted otherwise, the trademarks and service marks of Power-One Inc. in the U.S. and other countries. All other product or service names are the property of their respective holders. Power-One products are protected under numerous U.S. and foreign patents and pending applications, maskwork rights, and copyrights. Power-One reserves the right to make changes to any products and services at any time without notice. Power-One assumes no responsibility or liability arising out of the application or use of any information, product, or service described herein except as expressly agreed to in writing by Power-One Inc.

1. NUCLEAR AND MEDICAL APPLICATIONS - Power-One products are not designed, intended for use in, or authorized for use as critical components in life support systems, equipment used in hazardous environments, or nuclear control systems without the express written consent of the respective divisional president of Power-One, Inc.
2. TECHNICAL REVISIONS - The appearance of products, including safety agency certifications pictured on labels, may change depending on the date manufactured. Specifications are subject to change without notice.