

1

2

3

4

5

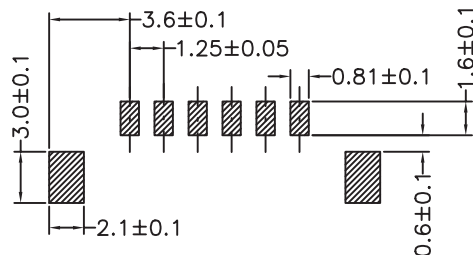
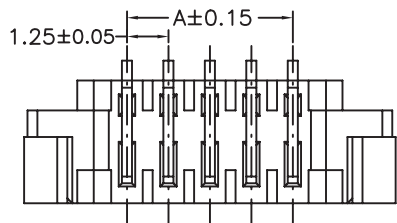

PCB LAYOUT - COMPONENT VIEW

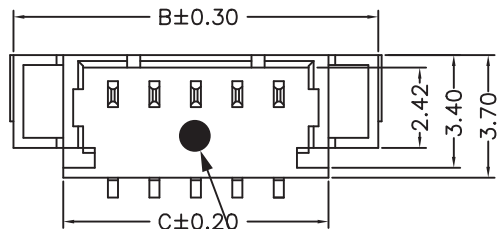
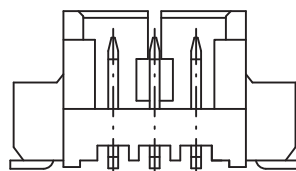
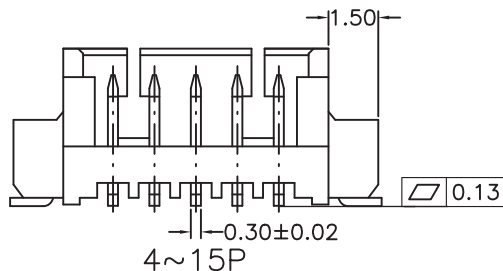
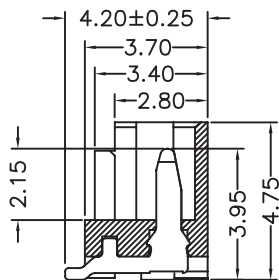

P&P ZONE FOR VACUUM NOZZLE

TECHNICAL CHARACTERISTICS

MATERIAL
 INSULATOR: NYLON 46
 FLAMABILITY RATING: UL94-V0
 COLOR: IVORY
 CONTACT MATERIAL: COPPER ALLOY
 CONTACT TYPE: STAMPED
 CONTACT PLATING: TIN
 QUALITY CLASS: 25 MATING CYCLES
 PITCH: 1.25MM

ENVIRONMENTAL
 OPERATING TEMPERATURE: -40 UP TO 85°C
 COMPLIANCE: LEAD FREE AND ROHS

ELECTRICAL
 CURRENT RATING: 1 A
 WORKING VOLTAGE: 125 VAC
 INSULATOR RESISTANCE: >100 MOHM
 DIELECTRIC WITHSTANDING VOLTAGE: 250 VAC/MN
 CONTACT RESISTANCE: 20 mOHM MAX

STANDARD
 CERTIFIED: E323964

SOLDERING
 JEDEC LEAD FREE REFLOW SOLDERING PROCESS

PACKAGING
 TAPE AND REEL

DIMENSION
 A = 1.25 x (NB PIN - 1)
 B = 1.25 x (NB PIN + 1) + 3.5
 C = 1.25 x (NB PIN + 1) + 0.5

RoHS Compliant

PROJECTION:

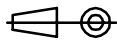

GENERAL TOLERANCE

.X = +/- 0.2
 .XX = +/- 0.15



APPROVAL: BBu

UNIT: MM

SCALE:

SHEET: 1/3

DRAW: CEL KING

DESCRIPTION: 1.25 MM SMT MALE VERTICAL SHROUDED HEADER

WERI PART NO: 653 1xx 124 022

SIZE

A4

REV	DATE	FILE	BY
H	06-AUG-15	COLOR	AK

1

2

3

4

5

PULL OUT DIRECTION

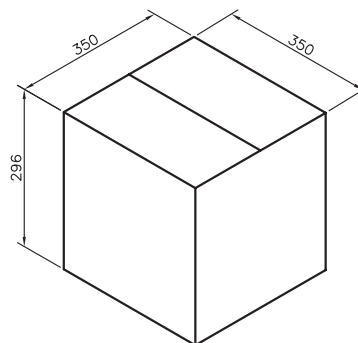
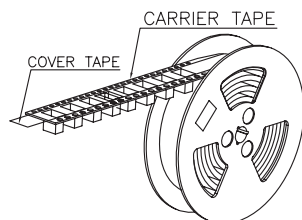
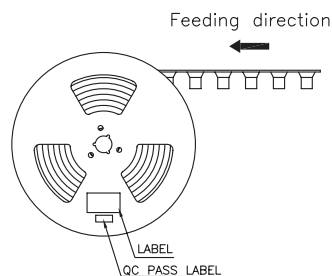
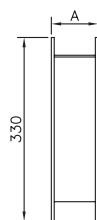
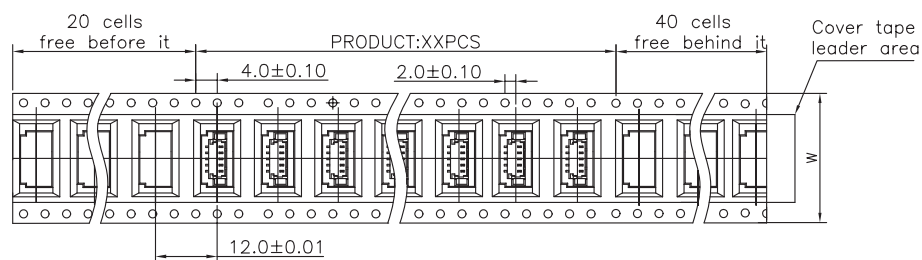
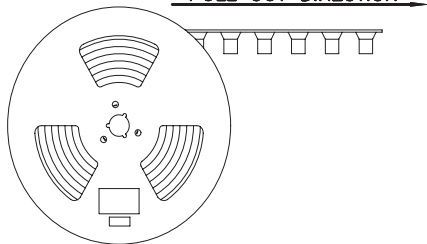

Note:

- All dimensions meet EIA-481-3 requirements.
- Material : Black Conductive Polystyrene Alloy
100% recyclable.
- Thickness : 0.40±0.05mm
- Component load per 13" reel :1000 pcs.
- For Reel width (dimension W)16,24mm
Single row hole, (dimension W)32,44
Double rows hole
- CARTON SIZE:350*350*296(MM)

Pin No	W	A	PCS/R	R/CTN	Q'TY
02	24	29	1000	7	7000
03	24	19	1000	7	7000
04	24	29	1000	7	7000
05	24	29	1000	7	7000
06	24	29	1000	7	7000
07	24	29	1000	7	7000
08	24	29	1000	7	7000
09	24	29	1000	7	7000
10	32	37	1000	6	6000
11	32	37	1000	6	6000
12	32	37	1000	6	6000
13	32	37	1000	6	6000
14	32	37	1000	6	6000
15	44	49	1000	5	5000

RoHS Compliant

PROJECTION:

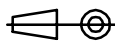

GENERAL TOLERANCE

.X = +/- 0.2

.XX = +/- 0.15



APPROVAL: BBu

UNIT: MM

SCALE:

SHEET: 2/3

DRAW: PEARL

DESCRIPTION: 1.25 MM SMT MALE VERTICAL SHROUDED HEADER

WERI PART NO: 653 1xx 124 022

SIZE

A4

G			
F			
E			
D			
C			
B			
A			
REV	DATE	FILE	BY

1

2

3

4

5

Cautions and Warnings:

This electronic component is designed and developed with the intention for use in general electronics equipments.

Before incorporating the components into any equipments in the field such as aerospace, aviation, nuclear control, submarine, transportation, (automotive control, train control, ship control), transportation signal, disaster prevention, medical, public information network etc. where higher safety and reliability are especially required or if there is possibility of direct damage or injury to human body, Würth Elektronik must be asked for a written approval.

In addition, even electronic component in general electronic equipments, when used in electrical circuits that require high safety, reliability functions or performance, the sufficient reliability evaluation-check for the safety must be performed before by the user before usage.

A

B

C

RoHS Compliant

G				PROJECTION: 	GENERAL TOLERANCE .X = +/- 0.2 .XX = +/- 0.15		
F							
E							
D							
C				APPROVAL: JC	UNIT: MM	DESCRIPTION: DISCLAIMER	SIZE A4
B					SCALE:		
A	10-SEP-14	PDF	QL		SHEET: 3/3	WERI PART NO: DISCLAIMER	
REV	DATE	FILE	BY		DRAW: QL		

D