



CURTIS

Instrumentation



Solid State Digital Hourmeters & Counters

700 Series



700 Series

Solid State Digital Hourmeters & Counters



Curtis Solid-State Module Assemblies are designed for OEM applications. Curtis offers a wide selection of miniature AC & DC meter assembly modules for PC board mounting applications.

700–703: Single-function 6-digit display for Counter or Hour Meter configurations.

708 & 721: Dual channel, 6 & 7digit display for Maintenance/ Hour Meter or Trip Odometer configurations.

720: Single channel 7-digit Odometer configuration.

These models offer a variety of functions, sizes, voltages and customizable options to fit most applications. Ideal for OEMs, contract manufacturers, and panel makers for monitoring equipment usage, scheduling maintenance, warranty validation, rental/leasing use and more. Used extensively in industrial, agricultural, military & specialty vehicles, as well as applications such as: vending machines, medical & office equipment, fuel pumps, and consumer products.

FEATURES

- ▶ Selection—hour meters, counters, odometers, maintenance monitors and more.
- ▶ Solid State Circuitry—no moving parts to wear out. Silent operation and years of rugged & reliable operation.
- ▶ Crisp, clean readouts—high-contrast 5 & 7mm LCD displays.
- ▶ Versatility—compact module designs with high quality components to minimize space.
- ▶ AC/DC Configurations—wide range of operating voltages & noise protection.
- ▶ OEM Compatibility—an unparalleled selection of power compatibility, design configurations and functionality for OEM custom designs, panel makers and contract manufacturers.
- ▶ Distinctive Icons—clear indicators for hour meter/ timer activation and display modes.
- ▶ Backlighting—available on all models (see model coding chart or consult factory).
- ▶ EEPROM memory—nonvolatile, retention of data for as much as 25 yrs.+ without power.
- ▶ Manufactured under ISO 9001 Certified Quality Management System.
- ▶ Low power consumption.
- ▶ UL and CE recognized.

See a 360° view of the 700 Series at:
curtisinstruments.com/360view

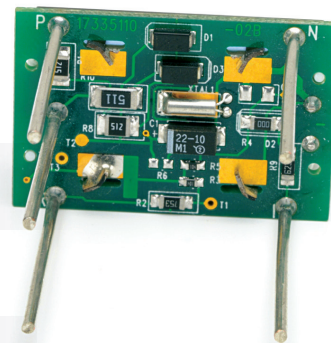
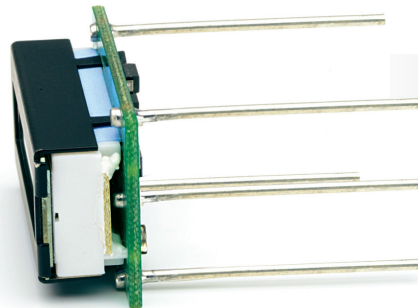

700 Series

Solid State Digital Hourmeters & Counters



MODEL CODING ASSEMBLY MODULES 700, 701, 703

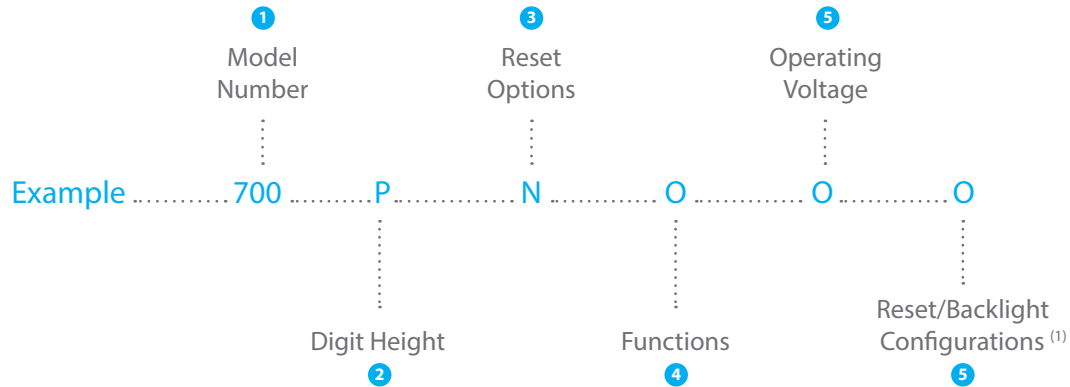

1 MODEL NUMBER

700	(6-digit) Hour Meter
701	(6-digit) Hour Meter
703	(6-digit) Pulse Counter

2 DIGIT HEIGHT

P	5mm digits
P7 ⁽²⁾	7mm digits

3 RESET OPTIONS

R	Wired Reset
N ²	No Reset

4 OPERATING VOLTAGE

0	AC/DC (700 Only)
1	Epoxy filled unit (moisture resistant, Q, R (5mm), cases only)
2	7mm, backlit display (R or S case only)
4	AC/DC with wired Enable (701 & 703 only)

5 RESET/BACKLIGHT CONFIGURATIONS

0	No Reset, No Backlight
2	Reset, No Backlight
4	Reset, External Backlight
5	No Reset, External Backlight
H	Reset, Internal Backlight ⁽²⁾
J	No Reset, Internal Backlight ⁽²⁾

NOTES:

1. All external backlight configurations—require 12 VDC (only) connection to illumination pin.
2. 7mm models—Backlighting only available as External.
3. Available only in 5mm & with voltage option 4 only.



700 Series

Solid State Digital Hourmeters & Counters



MODEL CODING ASSEMBLY MODULES 708, 720, 721

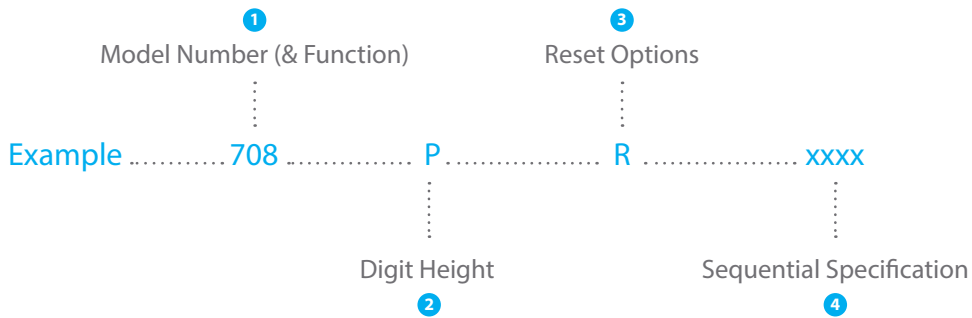

① MODEL NUMBER (& FUNCTION)

708	(6-digit) Dual Channel Maintenance/ Hour Meter
720	(7-digit) Single Channel Odometer
721	(7-digit) Dual Channel Odometer/Trip Odometer

② DIGIT HEIGHT

All Models	
P	5mm digits

③ RESET OPTIONS

Model 708/721	
R	Wired Reset for Maintenance or Trip Display
Model 708/720	
R	Wired Reset

④ SEQUENTIAL SPECIFICATION

Consult Curtis for:	Display Format
	Voltages
	Connection Termination
	Backlighting
	Pre-scaling
	Programming Options

700 Series

Solid State Digital Hourmeters & Counters



SPECIFICATIONS

Display	6-digit, 5 or 7 mm high	Models 700, 701, 703
	Dual-Channel 6-digit, 5 mm high	Model 708
	7-digit, 5 mm high	Model 720
	Dual-Channel 7-digit, 5 mm high	Model 721
Range & Resolution	Hour meters: 99,999.9 hours	Models 700, 701, 708
	Maintenance: 3,999.9 hrs.	Model 708/2nd Channel
	Counters: 999,999 counts	Models 700
	Odometers: 999,999.9 increments	Model 720, 721
	9,999,999	Model 720 (optional resolution)
	Trip: 999.9	Model 721 (2nd channel)
Accuracy	Hour Meters $\pm 0.1\%$	Models 700, 701, 708
	Counters ± 1 count	Models 703
	Odometers ± 1 increment	Models 720, 721
Humidity	95%, non-condensing at 38°C	

700 Series

Solid State Digital Hourmeters & Counters



SPECIFICATIONS continued

Operating Temperature	-40°C to +85°C (-40°F to +185°F)	
Storage Temperature	-50°C to +85°C (-58°F to +185°F)	
Operating Frequency (AC powered units)	48 to 440 Hz abs	
Memory	Main power must be applied for 5 sec to activate memory (with no loss of time/counts). EEPROM-Data retention 25+ years without power present.	
Input Signal (DC Only)	Counter	Model 703 - 500 Hz max, 50% duty cycle (1ms low, min, between consecutive highs)
	Maintenance Monitor	Models 701, 708 - Power must be applied for 0.5 sec, min, to accumulate time.
	Odometer	Model 720 - Varies depending on model configuration (consult factory)..
	Trip/Odometer	Model 721 - 500 Hz max, 50% duty cycle (1ms low, min, between consecutive highs).
Input Signal (AC/DC)	Hour Meter	Models 701, 708 - Power must be applied for 0.5 sec, min, to accumulate time.
	Counter	Model 703 - 1 Hz max, 50% duty cycle (500ms low, min, between consecutive highs).
Reset	0.5mA max. @ 5VDC (0512D models)	
	All Models	Main power must be applied for a minimum of 0.5 sec. prior to reset signal.
	Models 700, 701, 703	50ms, min, at operating voltage.
	Model 708	Maintenance 2 or 4 sec, factory programmed; hour meter not resettable.
	Model 720	70ms min at operating voltage.
	Model 721	Trip channel 2 or 4 sec, factory programmed; odometer is not resettable. Note: Max Reset frequency is 150Hz for AC models.

Notes:

1. All modules are supplied with critical components exposed. If the module is being used in an environment other than specified, the user must take precautions to package the module to provide adequate protection.
2. For proper mechanical support, all module pins should be soldered to the PC-board.
3. To prevent heat damage to components, module face should be 10-20mm minimum away from PC-board when flow soldered.

700 Series

Solid State Digital Hourmeters & Counters



CURRENT CONSUMPTION: (MA MAX)

	Operating Voltage at Power Terminals	700, 701, 703 (5mm)	700, 701, 703 (7mm)	708 (5mm)	721 (5mm)
External or No Backlight Models	5 – 12	VDC (@ 5 V)	0.5	0.5	N/A
	12 – 48	VDC (@ 12 V)	0.8	0.8	N/A
	48 – 150	VDC (@ 48 V)	0.8	0.8	N/A
	100 – 230	VAC (@ 120 V)	1.0	1.0	N/A
	100 – 230	VAC (@ 230 V)	2.0	2.0	N/A
Internal Backlight Models	9 – 15 VDC (@12V)	VDC (only)	3.5	N/A	N/A

DIMENSIONS mm

MODELS 700, 701, 703 - 5MM DIGITS



Non-Backlight

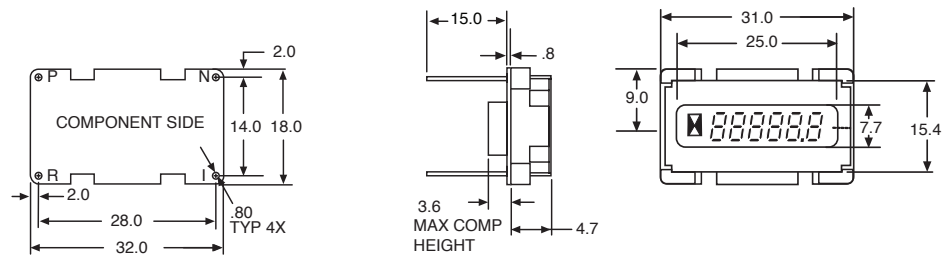

Backlight

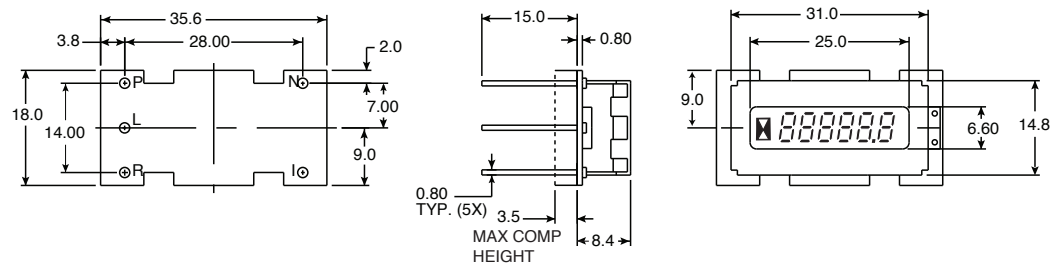

Note:
Standard pin lengths are shown. Optional lengths are available.

700 Series

Solid State Digital Hourmeters & Counters



DIMENSIONS mm continued

MODELS 700, 701, 703 - 7MM DIGITS

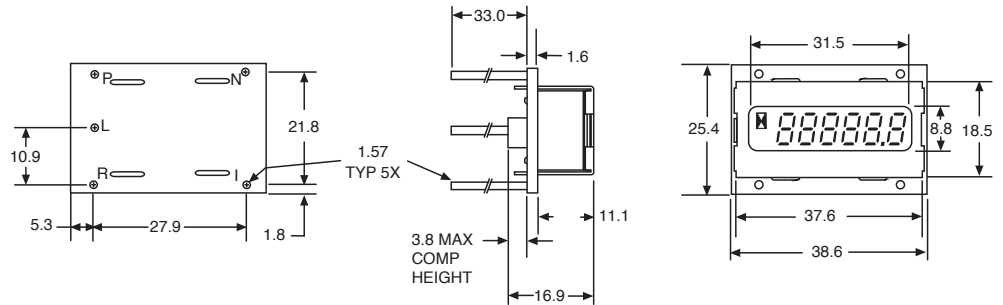

MODEL 708

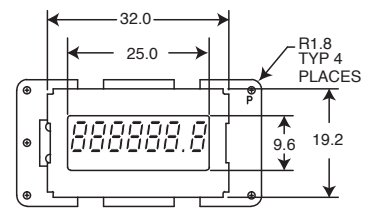
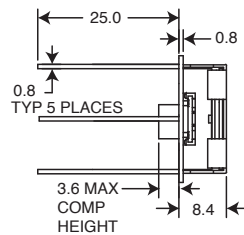
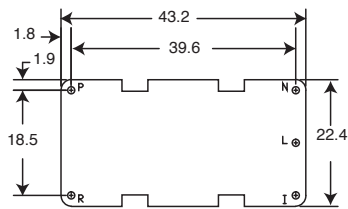
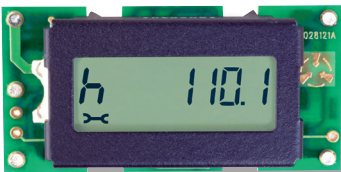

MODEL 721



Note:
Standard pin lengths are shown. Optional lengths are available.

700 Series

Solid State Digital Hourmeters & Counters



DIMENSIONS mm continued

MODEL 720

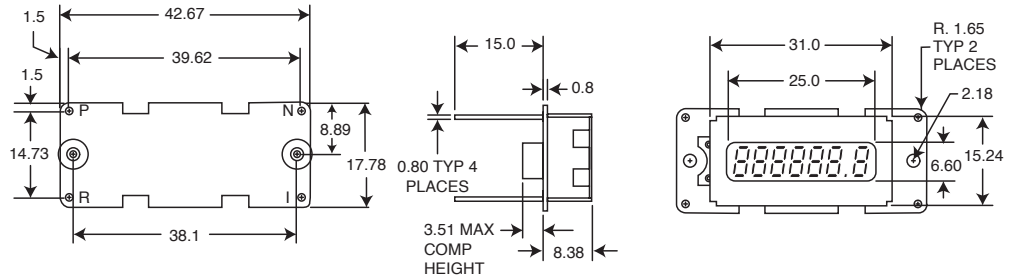

Note:

Standard pin lengths are shown. Optional lengths are available.

MODULE WIRING GUIDE

Pin	Assignment
P	V+
N	V- (common)
I	Enable V+ to activate elapsed time (Optional on 701, 708, N/A on 700) or increment count (703, 720, 721).
R	Reset V+ to reset count/elapsed time to zero (720, Optional on 700, 701, 703) or resettable channel to zero (Models 708, 721).
L	Illumination Control - 12 VDC only (Optional, external backlight units only) 9-15 VDC absolute, regardless of operating voltage.

WARRANTY Two year limited warranty from time of delivery.

The Curtis Difference 
 You feel it when you drive it