

SMD Power Inductor CDRH124



Description

- Ferrite drum core construction.
- Magnetically shielded.
- L × W × H: 12.3 × 12.3 × 4.5 mm Max.
- Product weight: 2.3g(Ref.)
- Moisture Sensitivity Level: 1
- RoHS compliance.

Environmental Data

- Operating temperature range: -40°C~+100°C (including coil's self temperature rise)
- Storage temperature range: -40°C~+100°C
- Solder reflow temperature: 260 °C peak.

Packaging

- Carrier tape and reel packaging
- 12.9" diameter reel
- 500pcs per reel

Applications

- Ideally used in Notebook PC, LCD TV, DVD, Game machine, STB, Projector etc as DC-DC converter inductors.

Dimension - [mm]

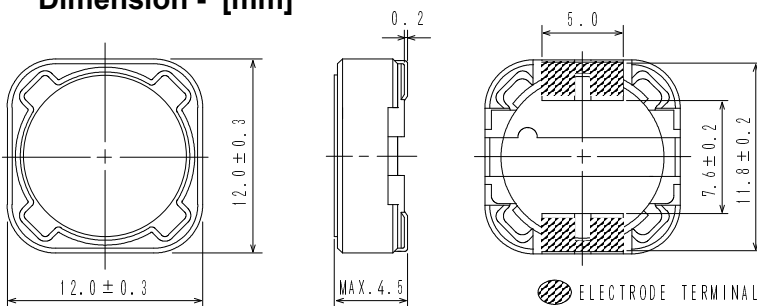

Land pattern and Schematics - [mm]

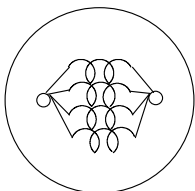
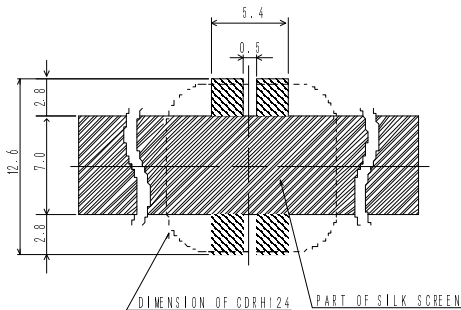

3.9 μH ~ 10 μH

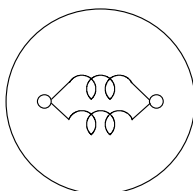

12 μH ~ 47 μH,
68 μH, 82 μH

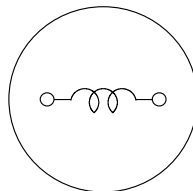

56 μH,
100 μH ~ 330 μH

SMD Power Inductor CDRH124



Electrical Characteristics

| Part Name | Stamp | Inductance (μ H) [within] ※1 | D.C.R. ($m\Omega$) [Max.] (Typ.) (at 20°C) | Rated current (A) ※2 |
|-----------------|-------|---|--|-------------------------|
| CDRH124NP-3R9MC | 3R9 | 3.9 \pm 20% | 15(12) | 6.5 |
| CDRH124NP-4R7MC | 4R7 | 4.7 \pm 20% | 18(14) | 5.7 |
| CDRH124NP-6R8MC | 6R8 | 6.8 \pm 20% | 23(18) | 4.9 |
| CDRH124NP-8R2MC | 8R2 | 8.2 \pm 20% | 26(21) | 4.6 |
| CDRH124NP-100MC | 100 | 10 \pm 20% | 28(22) | 4.5 |
| CDRH124NP-120MC | 120 | 12 \pm 20% | 38(30) | 4.0 |
| CDRH124NP-150MC | 150 | 15 \pm 20% | 50(40) | 3.2 |
| CDRH124NP-180MC | 180 | 18 \pm 20% | 57(46) | 3.1 |
| CDRH124NP-220MC | 220 | 22 \pm 20% | 66(53) | 2.9 |
| CDRH124NP-270MC | 270 | 27 \pm 20% | 80(64) | 2.8 |
| CDRH124NP-330MC | 330 | 33 \pm 20% | 97(78) | 2.7 |
| CDRH124NP-390MC | 390 | 39 \pm 20% | 132(106) | 2.1 |
| CDRH124NP-470MC | 470 | 47 \pm 20% | 150(120) | 1.9 |
| CDRH124NP-560MC | 560 | 56 \pm 20% | 190(152) | 1.8 |
| CDRH124NP-680MC | 680 | 68 \pm 20% | 220(176) | 1.5 |
| CDRH124NP-820MC | 820 | 82 \pm 20% | 260(208) | 1.3 |
| CDRH124NP-101MC | 101 | 100 \pm 20% | 308(246) | 1.2 |
| CDRH124NP-121MC | 121 | 120 \pm 20% | 380(304) | 1.1 |
| CDRH124NP-151MC | 151 | 150 \pm 20% | 530(424) | 0.95 |
| CDRH124NP-181MC | 181 | 180 \pm 20% | 620(496) | 0.85 |
| CDRH124NP-221MC | 221 | 220 \pm 20% | 700(560) | 0.8 |
| CDRH124NP-271MC | 271 | 270 \pm 20% | 870(696) | 0.6 |
| CDRH124NP-331MC | 331 | 330 \pm 20% | 990(792) | 0.5 |

※1. Inductance measuring condition: at 100 kHz.

※2. Rated current: The DC current at which the inductance decreases to 75% of its nominal value or when $\Delta t=40^{\circ}\text{C}$, whichever is lower.

SMD Power Inductor CDRH124

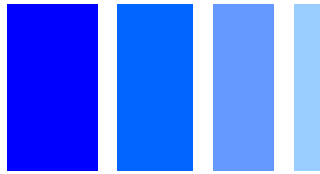

Saturation Current & Temperature Rise Graph

— L (20°C) — L (100°C) — ΔT

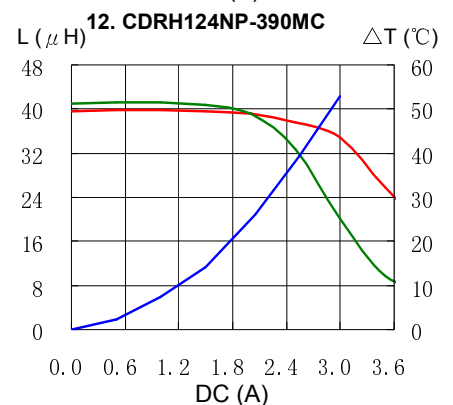
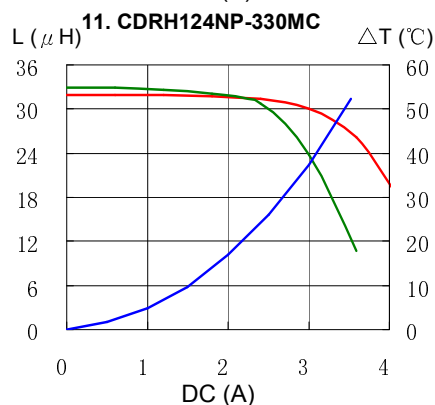
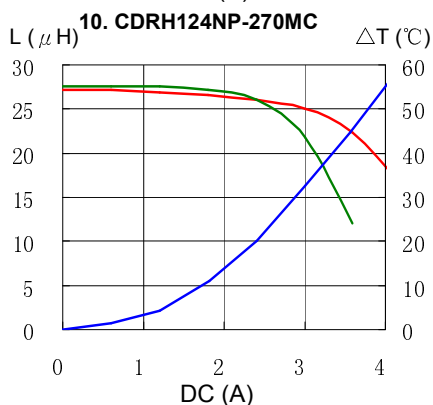
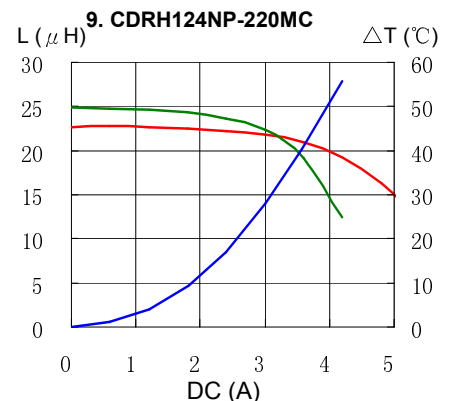
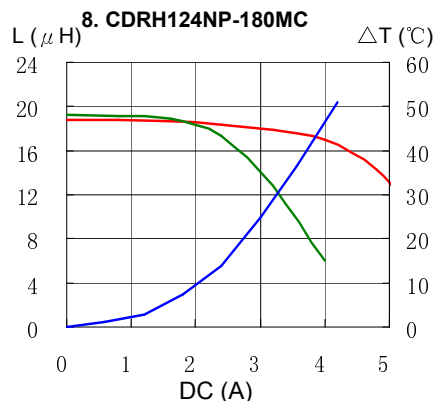
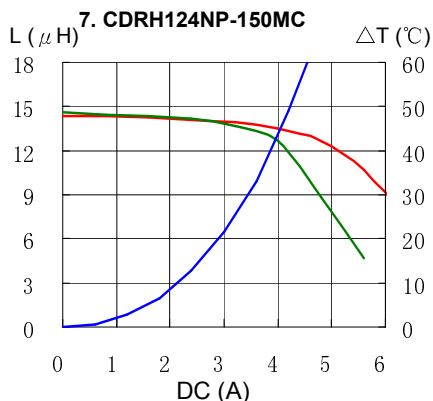
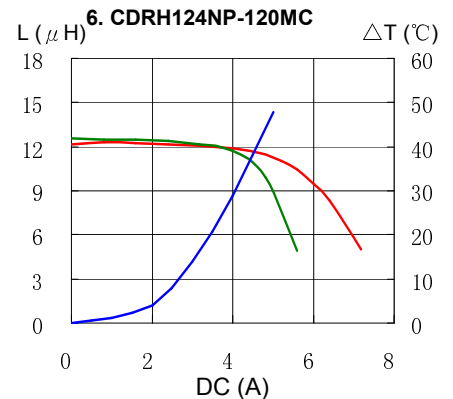
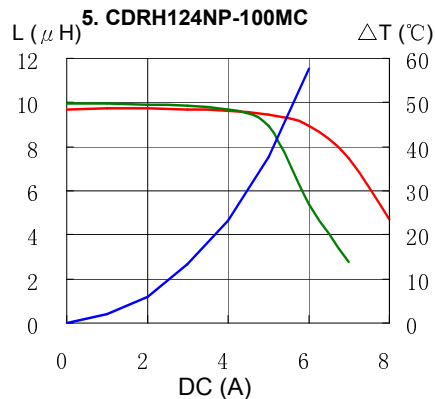
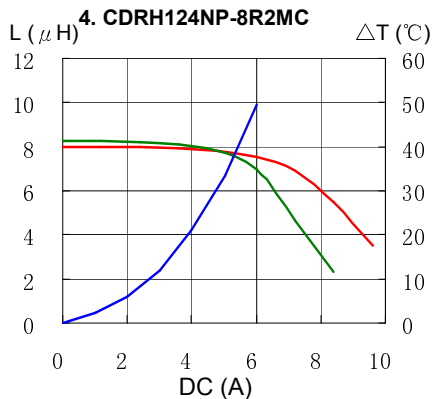
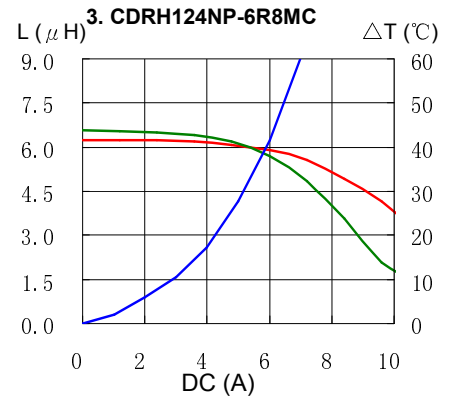
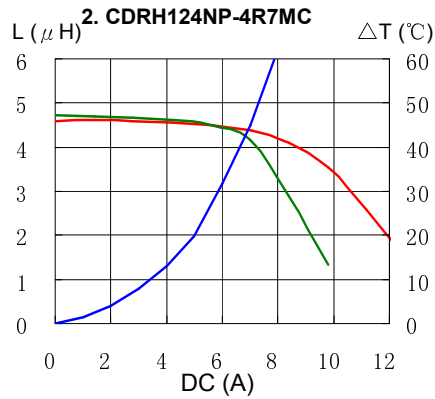
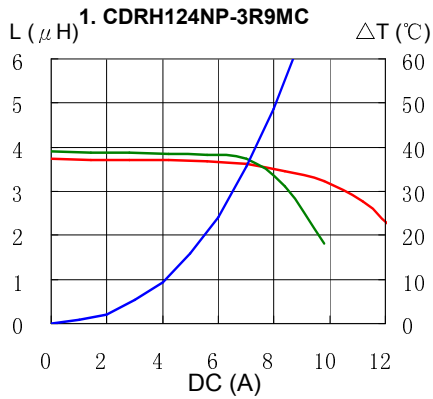

SMD Power Inductor CDRH124

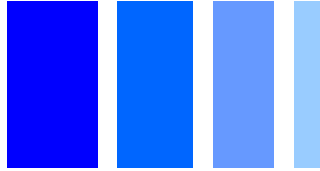

Saturation Current & Temperature Rise Graph

— L (20°C) — L (100°C) — ΔT

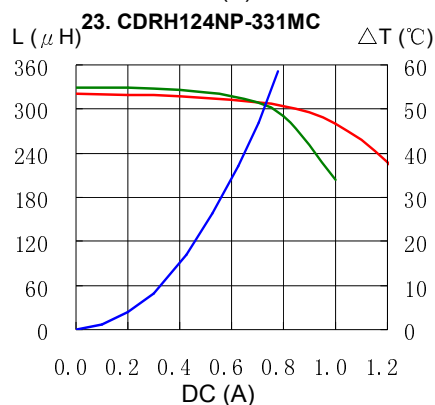
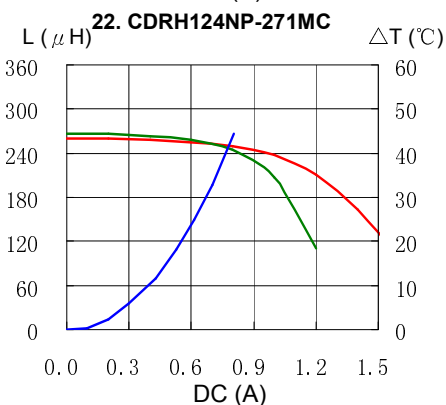
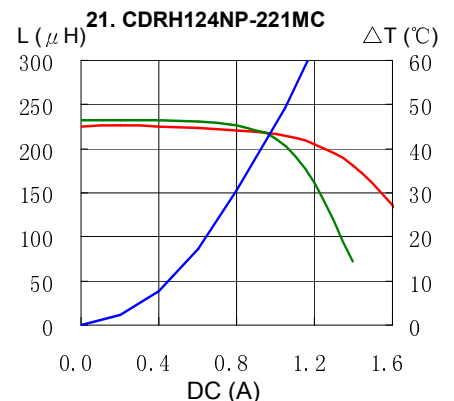
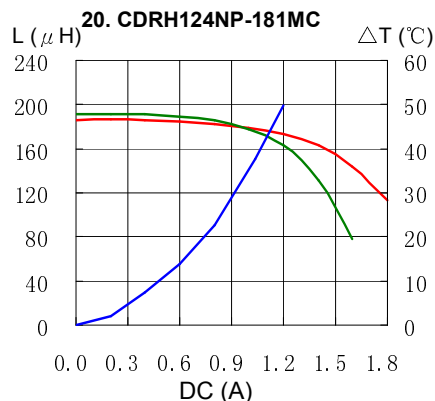
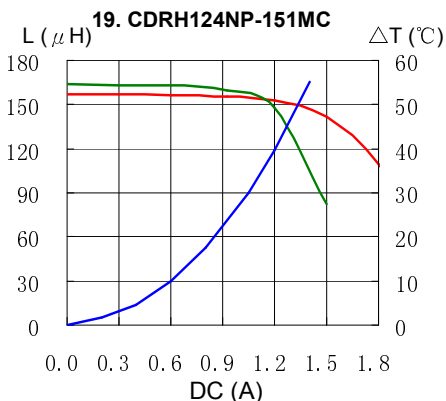
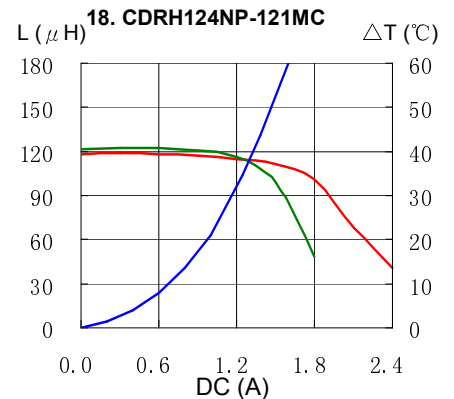
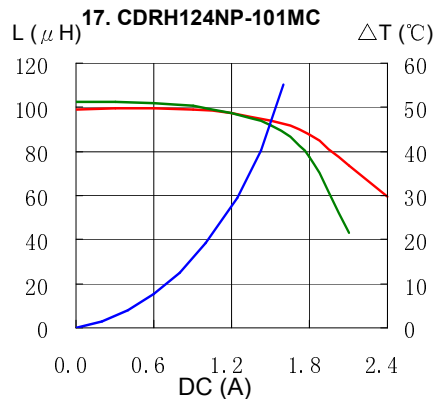
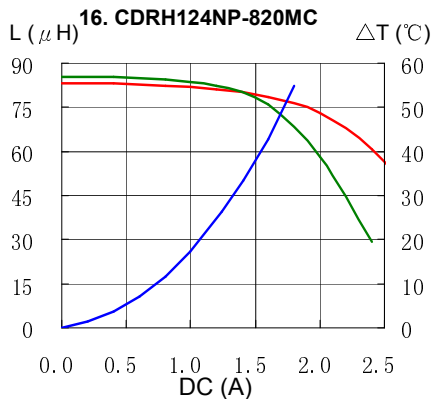
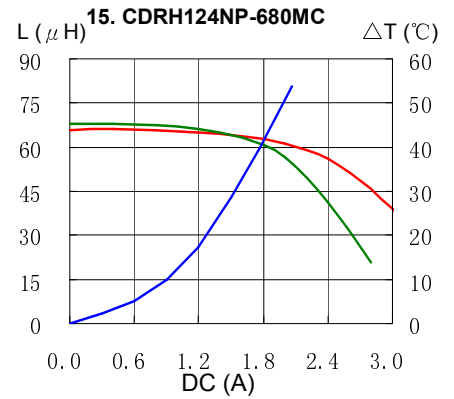
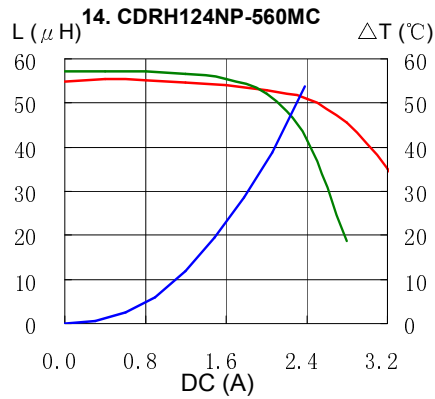
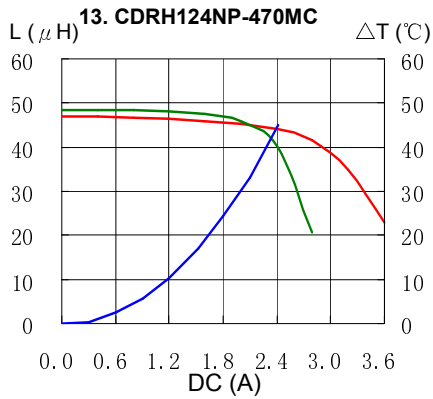

SMD Power Inductor CDRH124



Solder Reflow Condition

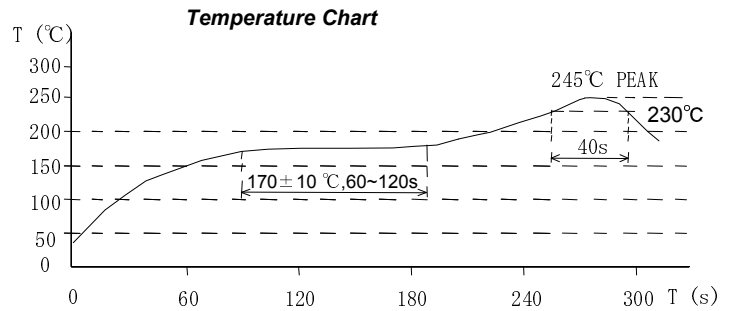
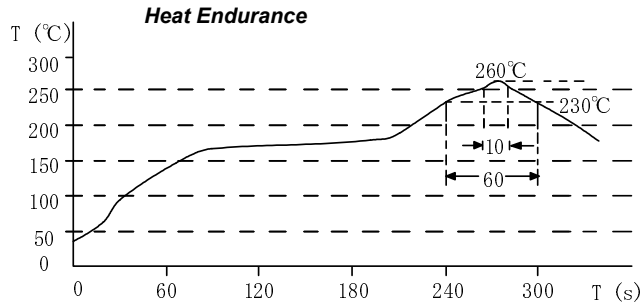

Please refer to the sales offices on our website - <http://www.sumida.com>

Hong Kong
Tel.+852-2880-6781
FAX.+852-2565-9600
sales@hk.sumida.com

Saitama(Japan)
Tel.+81-48-691-7300
FAX.+81-48-691-7340
sales@jp.sumida.com

Chicago
Tel.+1-847-545-6700
FAX. +1-847-545-6720
sales@us.sumida.com

Shanghai
Tel.+86-21-5836-3299
FAX.+86-21-5836-3266
shanghai.sales@cn.sumida.com

Seoul
Tel.+82-2-6237-0777
FAX.+82-2-6237-0778
sales@kr.sumida.com

Oberzell
Tel.+49-8591-937-0
FAX. +49-8591-937-103
contact@eu.sumida.com

Shenzhen
Tel.+86-755-8291-0228
FAX.+86-755-8291-0338
shenzhen.sales@cn.sumida.com

Singapore
Tel.+65-6296-3388
FAX.+65-6841-4426
sales@sg.sumida.com

Neumarkt
Tel.+49-9181-4509-110
FAX. +49-9181-4509-310
infocomp@eu.sumida.com

Taipei
Tel.+886-2-8751-2737
FAX.+886-2-8751-2738
sales@tw.sumida.com

San Jose
Tel.+1-408-321-9660
FAX.+1-408-321-9308
sales@us.sumida.com