



Features

- Semi-shielded construction
- Inductance range: 1 to 220 μ H
- Rated current up to 8 A
- AEC-Q200 qualified
- RoHS compliant* and halogen free**

Applications

- Automotive systems:
 - Driver assistant
 - Infotainment
 - Lighting
- DC/DC converters
- Power supplies
- Digital video cameras
- HDDs
- Smartphones
- Televisions, LCD displays

SRN6045TA Series - Semi-shielded Power Inductors

Electrical Specifications @ 25 °C

Bourns Part No.	Inductance @ 1 MHz / 1 V		Q (Min.) @ 1 MHz	SRF (MHz) Typ.	DCR (m Ω) \pm 20 %	I _{rms} (A) Typ.	I _{sat} (A) Typ.
	L (μ H)	Tol. %					
SRN6045TA-1R0Y	1.0	\pm 30	15	110	10	8.00	13.50
SRN6045TA-1R2Y	1.2	\pm 30	15	90	10.5	7.50	12.5
SRN6045TA-1R5Y	1.5	\pm 30	15	75	11.7	7.00	12.0
SRN6045TA-2R2Y	2.2	\pm 30	15	55	15	6.00	9.50
SRN6045TA-3R3Y	3.3	\pm 30	15	45	21	5.00	7.80
SRN6045TA-4R7M	4.7	\pm 20	15	40	26	4.50	6.80
SRN6045TA-6R3M	6.3	\pm 20	15	35	33	3.80	5.90
SRN6045TA-6R8M	6.8	\pm 20	15	30	34	3.60	5.70
SRN6045TA-8R2M	8.2	\pm 20	15	27	46	3.40	5.10
SRN6045TA-100M	10	\pm 20	15	25	52	3.20	4.60
SRN6045TA-120M	12	\pm 20	15	22	65	3.00	4.00
SRN6045TA-150M	15	\pm 20	15	20	71	2.80	3.80
SRN6045TA-220M	22	\pm 20	15	17	96	2.30	3.30
SRN6045TA-330M	33	\pm 20	15	13	145	1.80	2.50
SRN6045TA-470M	47	\pm 20	15	12	200	1.60	2.00
SRN6045TA-560M	56	\pm 20	15	11	230	1.40	1.80
SRN6045TA-680M	68	\pm 20	15	10	305	1.10	1.60
SRN6045TA-820M	82	\pm 20	15	9	365	0.98	1.50
SRN6045TA-101M	100	\pm 20	15	8.5	456	0.92	1.33
SRN6045TA-121M	120	\pm 20	15	7	500	0.85	1.20
SRN6045TA-151M	150	\pm 20	15	6.5	626	0.75	1.10
SRN6045TA-181M	180	\pm 20	15	6	745	0.68	1.00
SRN6045TA-221M	220	\pm 20	15	5	900	0.60	0.88

General Specifications

Operating Temp. -55 °C to +125 °C
 (Temperature rise included)
 Storage Temperature .. -55 °C to +125 °C
 Temperature Rise 40 °C at rated I_{rms}
 Rated Current
 Inductance drops 30 % at I_{sat}
 Failure In Time (FIT) 24.7/10⁹ hours
 Mean Time Between Failures (MTBF)
 40.4 x 10⁶ hours

Materials

Core Ferrite
 Wire Enamelled copper
 Terminal Finish Sn
 Coating Magnetic epoxy resin
 Packaging 1000 pcs. per 13-inch reel

Product Dimensions

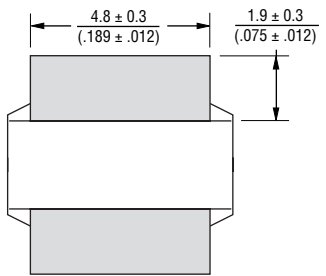
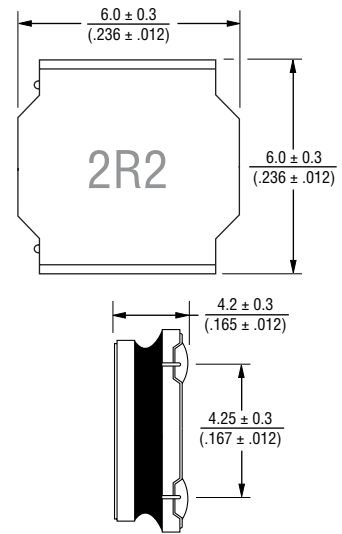

Electrical Schematic

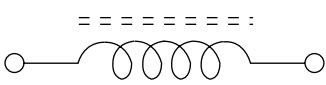

How to Order

SRN6045TA - 100M
 Model _____
 Value Code (see table) _____

Recommended Layout

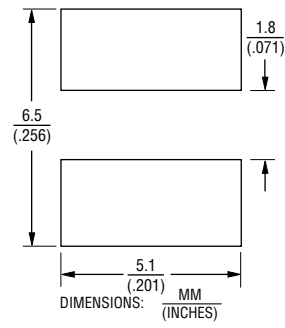

*RoHS Directive 2002/95/EC Jan. 27, 2003 including annex and RoHS Recast 2011/65/EU June 8, 2011.
 **Bourns considers a product to be "halogen free" if (a) the Bromine (Br) content is 900 ppm or less; (b) the Chlorine (Cl) content is 900 ppm or less; and (c) the total Bromine (Br) and Chlorine (Cl) content is 1500 ppm or less.
 Specifications are subject to change without notice.
 The device characteristics and parameters in this data sheet can and do vary in different applications and actual device performance may vary over time.
 Users should verify actual device performance in their specific applications.

SRN6045TA Series - Semi-shielded Power Inductors



Temperature Rise vs. Current

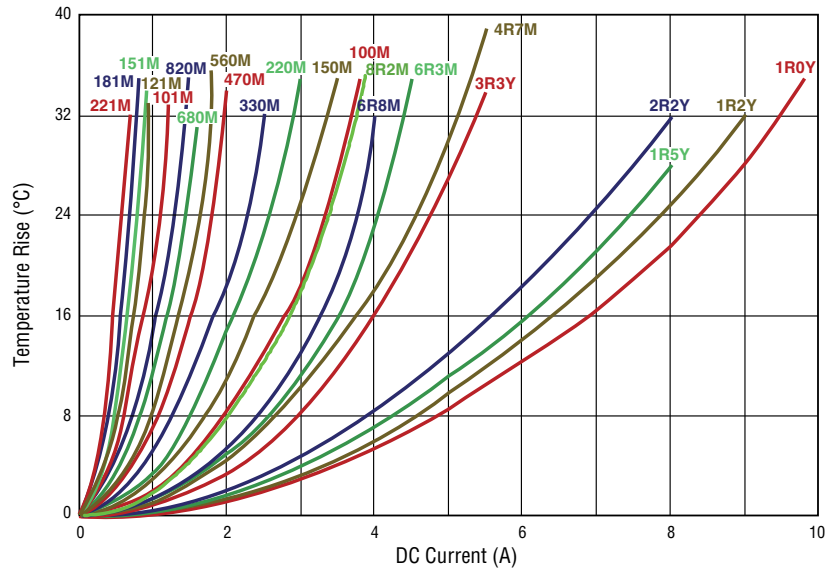

Inductance vs. Current

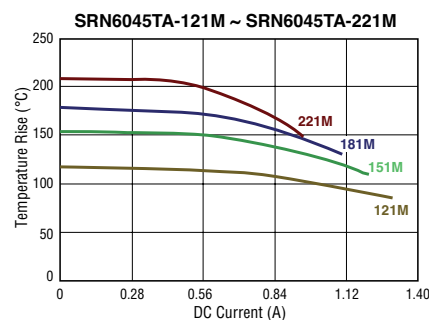
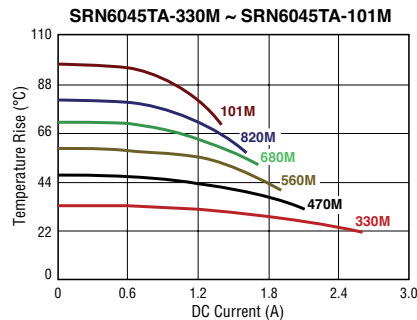
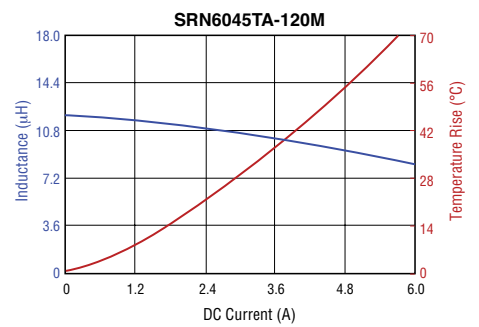
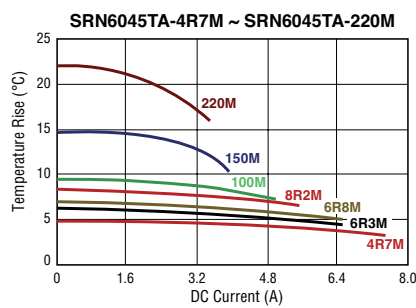
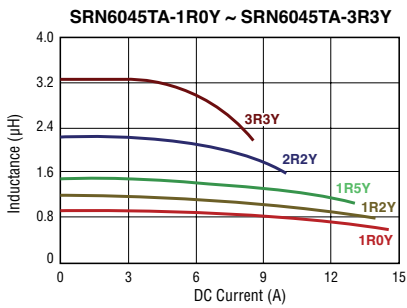

Specifications are subject to change without notice.
 The device characteristics and parameters in this data sheet can and do vary in different applications and actual device performance may vary over time.
 Users should verify actual device performance in their specific applications.

SRN6045TA Series - Semi-shielded Power Inductors

BOURNS®

Soldering Profile

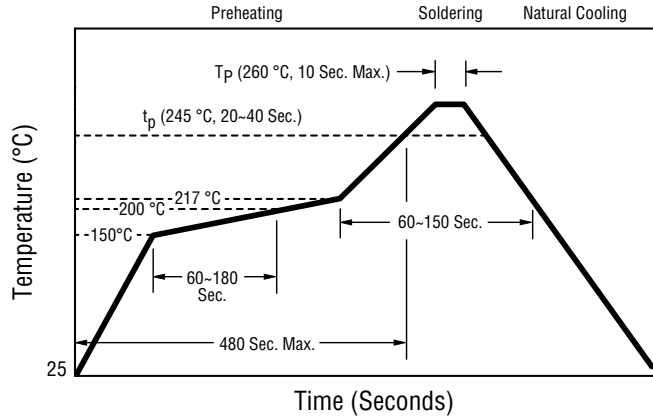

Packaging Specifications

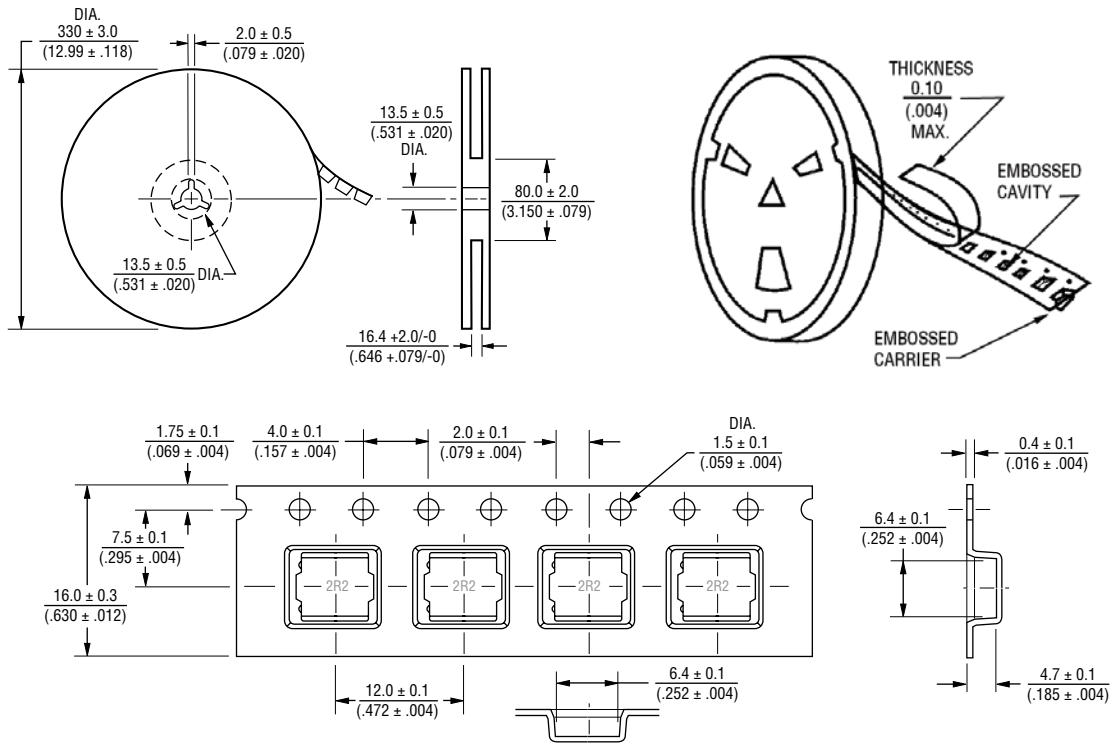

USER DIRECTION OF FEED →
QTY: 1000 PCS. PER REEL

DIMENSIONS: $\frac{\text{MM}}{\text{(INCHES)}}$

REV. 11/16

Specifications are subject to change without notice.
The device characteristics and parameters in this data sheet can and do vary in different applications and actual device performance may vary over time.
Users should verify actual device performance in their specific applications.