

# OS Series Miniature Slide Switches

## Features/Benefits

- Variety of actuators & terminations
- PC and panel mounting
- Gold or silver plating available
- Shorting or non-shorting contacts
- RoHS compliant
- Halogen free material

## Typical Applications

- Test & measurement equipment
- Computer peripherals & network products
- Consumer products

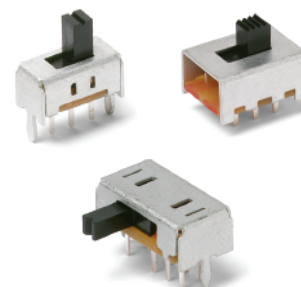

## Specifications

CONTACT RATING: See individual parts.  
 MECHANICAL & ELECTRICAL LIFE: 10,000 cycles.  
 CONTACT RESISTANCE: 20 mΩ or less.  
 INSULATION RESISTANCE: 100 MΩ min. at 500 VDC.  
 DIELECTRIC STRENGTH: 500 VAC for 1 minute.  
 OPERATING TEMPERATURE: -30°C to +70°C.  
 PACKAGING: Bulk

\* For RoHS compatible switches contact customer service.

## Materials

BASE: Phenolic resin.  
 ACTUATOR: POM, black.  
 HOUSING PLATE: Non-compatible; SPCC Sn plated.  
 Compatible; SPCC Ni plated.  
 MOVABLE CONTACT: Copper alloy, silver plated or gold.  
 STATIONARY CONTACTS: Brass, silver plated.  
 TERMINALS: Brass, silver plated (Gold plate - Contact customer service).  
 TERMINAL SEALED.

NOTE: Specifications and materials listed above are for switches with standard options. For information on specific and custom switches, consult Customer Service Center.

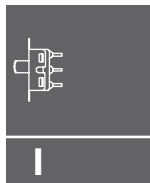

Slide

## How To Order

Complete part numbers for OS Series Slide Switches are shown on pages I-37 through I-43.

PART NUMBER			SWITCH FUNCTION	
	RoHS Compliant	RoHS Compatible	POS.1	POS.2
OS102011MS2QN1 (non-shorting)	YES	NO	ON	ON
OS102011MS2QN1C* (non-shorting)	YES	YES	ON	ON
OS102011MS2QS1 (shorting)	YES	NO	ON	ON
OS102011MS2QS1C* (shorting)	YES	YES	ON	ON
CONN. TERMINALS			1-2	2-3
SCHEMATIC				
 SPDT				

CONTACT RATING: 0.1A @ 12 VDC

\* "C" option at the end of part number designates high temperature actuators

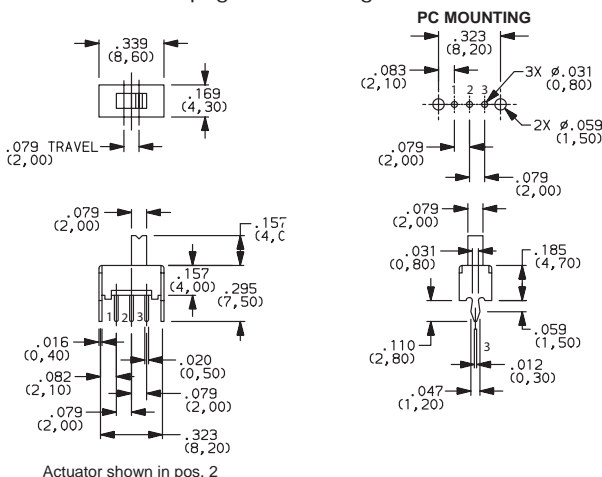

PART NUMBER			SWITCH FUNCTION		
	ROHS Compliant	ROHS Compatible	POS.1	POS.2	POS.3
OS103011MS8QP1 (Non-specified)	YES	NO	ON	ON	ON
OS103011MS8QP1C* (Non-specified)	YES	YES	ON	ON	ON
CONN. TERMINALS			1-2	2-3	2-4
SCHEMATIC					
 SP3T					

CONTACT RATING: 0.1A @ 12 VDC

\* "C" option at the end of part number designates high temperature actuators

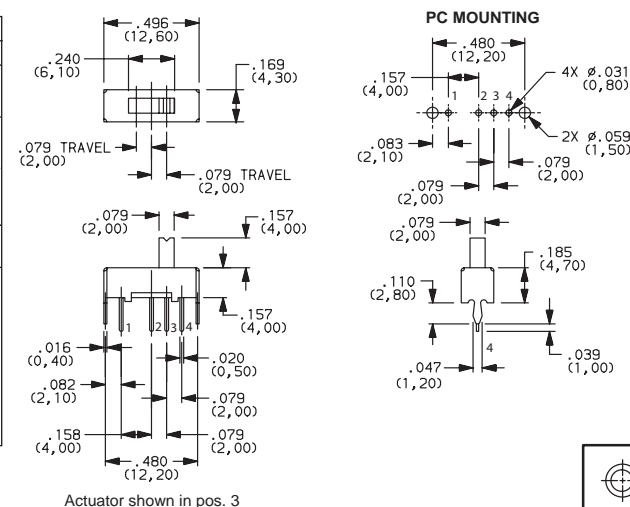

Dimensions are shown: Inches (mm)  
 Specifications and dimensions subject to change



9 nov 16

# OS Series Miniature Slide Switches

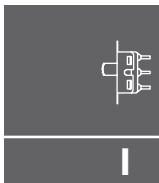

Slide

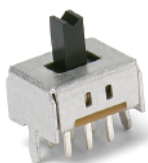

OS202011MS2QS1  
DPDT

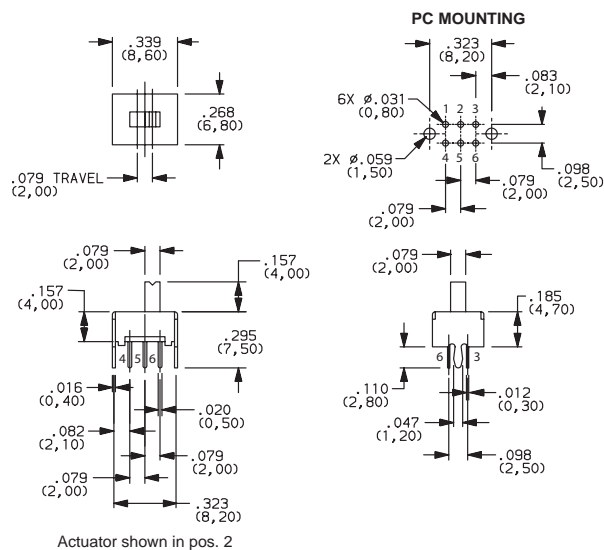

PART NUMBER	RoHS Compliant	RoHS Compatible	SWITCH FUNCTION	
			POS.1	POS.2
OS202011MS2QS1 (Shorting)	YES	NO	ON	ON
OS202011MS2QN1 (Non-shorting)	YES	NO	ON	ON
<b>CONN. TERMINALS</b>			1-2, 4-5	2-3, 5-6
<b>SCHEMATIC</b>				
DPDT				

CONTACT RATING: 0.1A @ 12 VDC

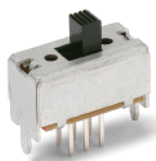

OS203011MS1QP1  
DP3T

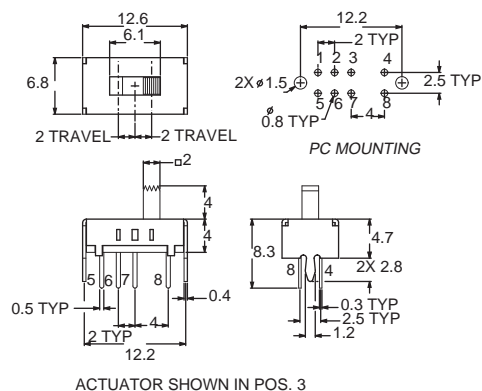

PART NUMBER	ROHS Compliant	ROHS Compatible	SWITCH FUNCTION		
			POS.1	POS.2	POS.3
OS203011MS1QP1 (Non-specified)	YES	NO	ON	ON	ON
<b>CONN. TERMINALS</b>			1-3, 5-7	2-3, 6-7	3-4, 7-8
<b>SCHEMATIC</b>					
DP3T					

CONTACT RATING: 0.3A @ 30 VDC

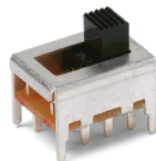

OS202013MT5QN1  
DPDT

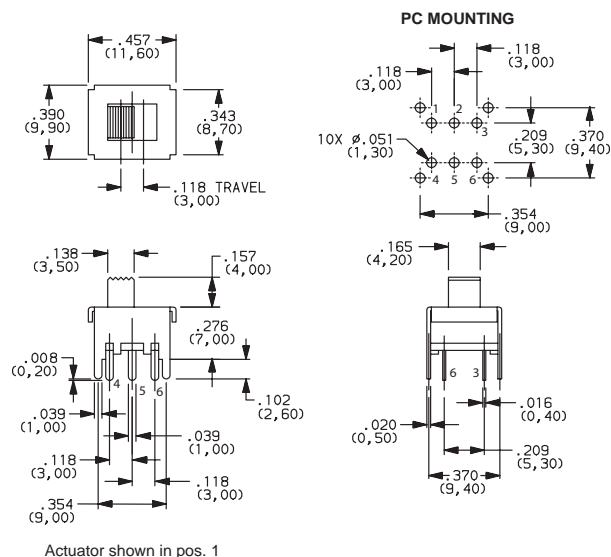

PART NUMBER	RoHS Compliant	RoHS Compatible	SWITCH FUNCTION	
			POS.1	POS.2
OS202013MT5QN1 (Non-shorting)	YES	NO	ON	ON
<b>CONN. TERMINALS</b>			1-2, 4-5	2-3, 5-6
<b>SCHEMATIC</b>				
DPDT				

CONTACT RATING: 0.3A @ 30 VDC

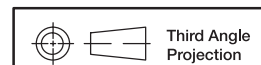

Dimensions are shown: Inch (mm)  
Specifications and dimensions subject to change



# OS Series Miniature Slide Switches

PART NUMBER	ROHS		SWITCH FUNCTION		
	Compliant	Compatible	POS.1	POS.2	POS.3
<b>OS203013MT7QN1</b> (Non-shorting)	YES	NO	ON	OFF	ON
<b>CONN. TERMINALS</b>			1-2, 4-5		2-3, 5-6
<b>SCHEMATIC</b>					
DP3T					

CONTACT RATING: 0.3A @ 30 VDC

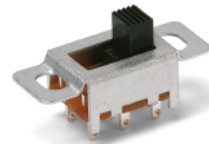
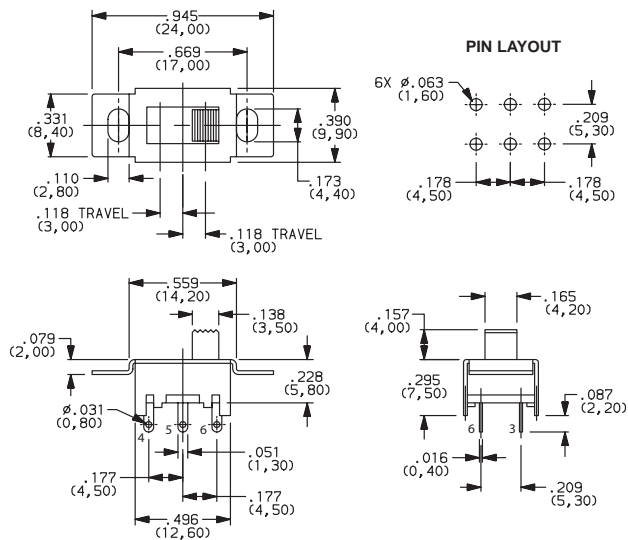

OS203013MT7QN1  
DP3T

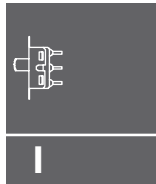

Slide

PART NUMBER	ROHS		SWITCH FUNCTION	
	Compliant	Compatible	POS.1	POS.2
<b>OS202013MT8QN1</b> (Non-shorting)	YES	NO	ON	ON
<b>CONN. TERMINALS</b>			1-2, 4-5	2-3, 5-6
<b>SCHEMATIC</b>				
DPDT				

CONTACT RATING: 0.3A @ 30 VDC

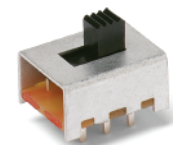
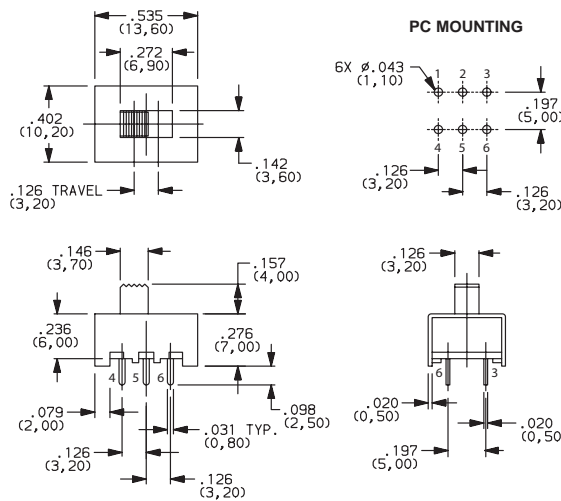

OS202013MT8QN1  
DPDT

PART NUMBER	ROHS		SWITCH FUNCTION		
	Compliant	Compatible	POS.1	POS.2	POS.3
<b>OS203013MT8QN1</b> (Non-shorting)	YES	NO	ON	ON	ON
<b>CONN. TERMINALS</b>			1-2, 5-6	2-3, 6-7	3-4, 7-8
<b>SCHEMATIC</b>					
DP3T					

CONTACT RATING: 0.3A @ 30 VDC

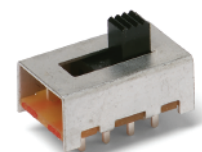
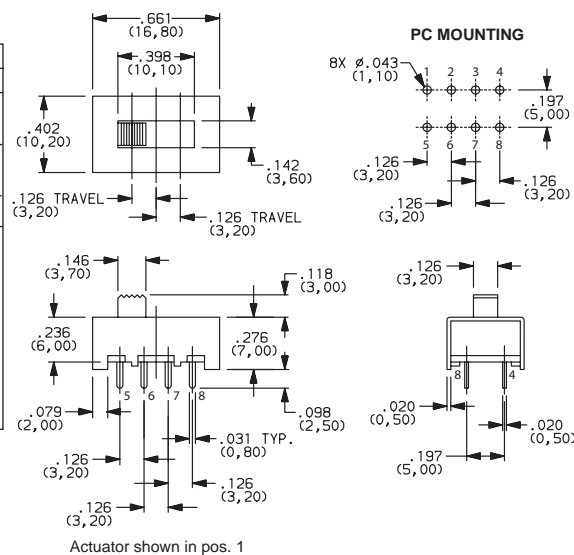

OS203013MT8QN1  
DP3T



Third Angle Projection  
Dimensions are shown: Inches (mm)  
Specifications and dimensions subject to change



9 nov 16

# OS Series Miniature Slide Switches

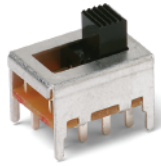

OS203013MT6QN1  
DP3T

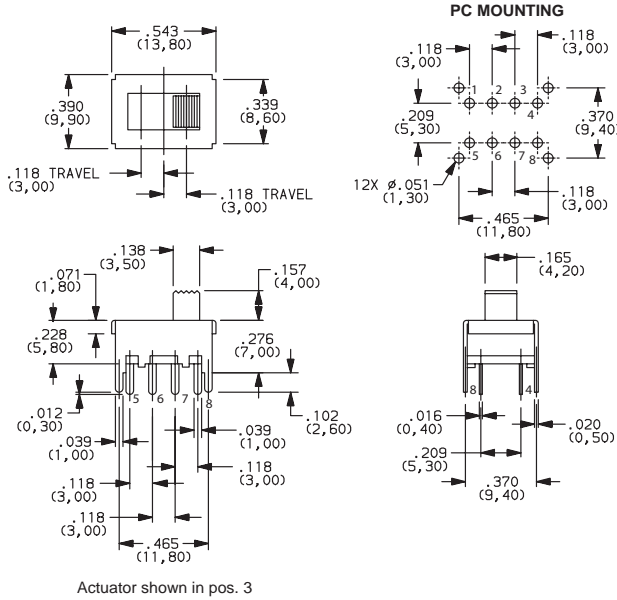

PART NUMBER	ROHS Compliant	ROHS Compatible	SWITCH FUNCTION		
			POS.1	POS.2	POS.3
OS203013MT6QN1 (Non-shorting)	YES	NO	ON	ON	ON
<b>CONN. TERMINALS</b>			1-2, 5-6	2-3, 6-7	3-4, 7-8
<b>SCHEMATIC</b>					
DP3T					

CONTACT RATING: 0.2A @ 30 VDC

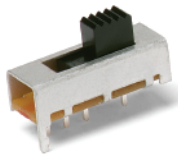

OS103012MU1QP1  
SP3T

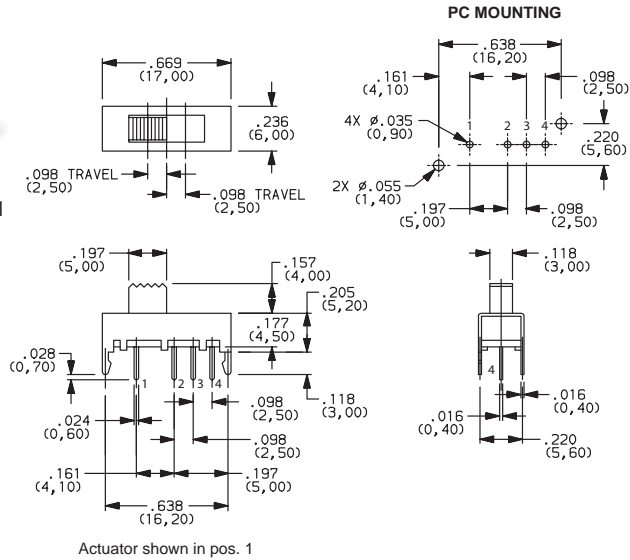

PART NUMBER	ROHS Compliant	ROHS Compatible	SWITCH FUNCTION		
			POS.1	POS.2	POS.3
OS103012MU1QP1 (Non-shorting)	YES	NO	ON	ON	ON
<b>CONN. TERMINALS</b>			1-2	2-3	2-4
<b>SCHEMATIC</b>					
SP3T					

CONTACT RATING: 0.2A @ 30 VDC

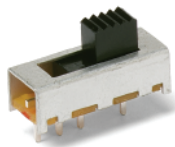

OS103012MU2QP1  
SP3T

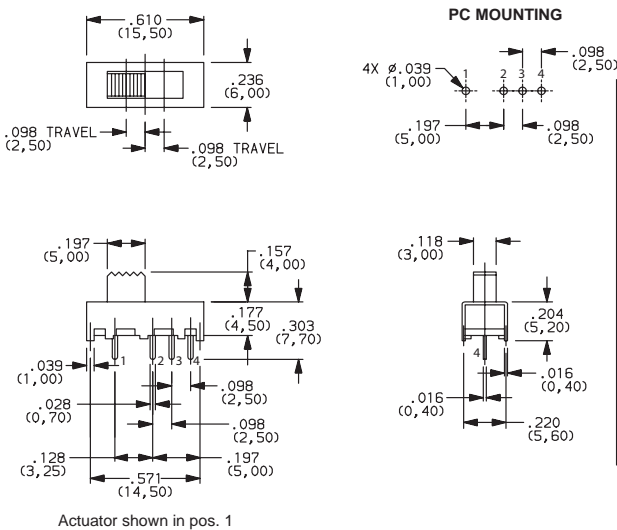

PART NUMBER	ROHS Compliant	ROHS Compatible	SWITCH FUNCTION		
			POS.1	POS.2	POS.3
OS103012MU2QP1 (Non-shorting)	YES	NO	ON	ON	ON
<b>CONN. TERMINALS</b>			1-2	2-3	2-4
<b>SCHEMATIC</b>					
SP3T					

CONTACT RATING: 0.2A @ 30 VDC

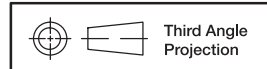

Dimensions are shown: Inch (mm)  
Specifications and dimensions subject to change



Slide

# OS Series Miniature Slide Switches

PART NUMBER	ROHS		SWITCH FUNCTION		
	Compliant	Compatible	POS.1	POS.2	POS.3
<b>OS203012MU5QP1</b> (Non-specified)	YES	NO			
<b>CONN. TERMINALS</b>			1-2, 5-6	2-3, 6-7	2-4, 6-8
<b>SCHEMATIC</b>					
DP3T					

CONTACT RATING: 0.1A @ 30 VDC

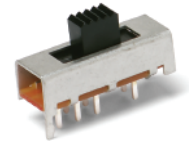
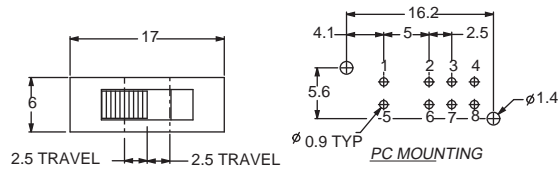

OS203012MU5QP1  
DP3T

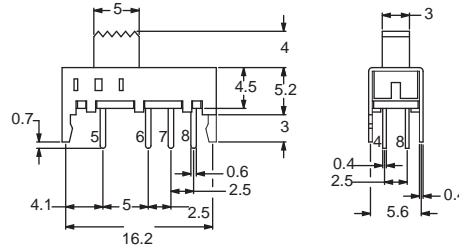

ACTUATOR SHOWN IN POS. 1

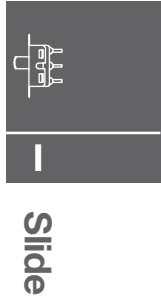

PART NUMBER	RoHS		SWITCH FUNCTION	
	Compliant	Compatible	POS.1	POS.2
<b>OS202011MV4QN1</b> (Non-shorting)	YES	NO		
<b>OS202011MV4QS1</b> (Shorting)	YES	NO		
<b>CONN. TERMINALS</b>			1-2, 4-5	2-3, 5-6
<b>SCHEMATIC</b>				
DPDT				

CONTACT RATING: 0.1A @ 30 VDC

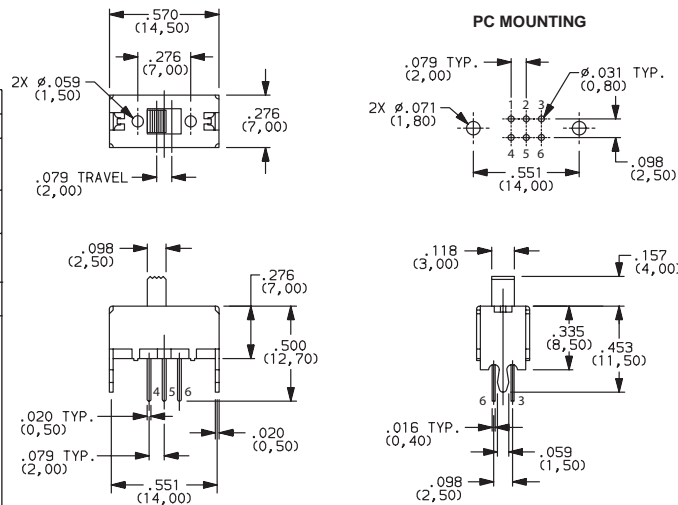

Actuator shown in pos. 1

OS202011MV4QN1  
DPDT

PART NUMBER	ROHS		SWITCH FUNCTION		
	Compliant	Compatible	POS.1	POS.2	POS.3
<b>OS203011MV9QS1</b> (Shorting)	YES	NO			
<b>OS203011MV9QN1</b> (Non-Shorting)	YES	NO			
<b>CONN. TERMINALS</b>			1-2-5 6-7-10	1-3-5 6-8-10	1-4-5 6-9-10
<b>SCHEMATIC</b>					
DP3T					

CONTACT RATING: 0.1A @ 30 VDC

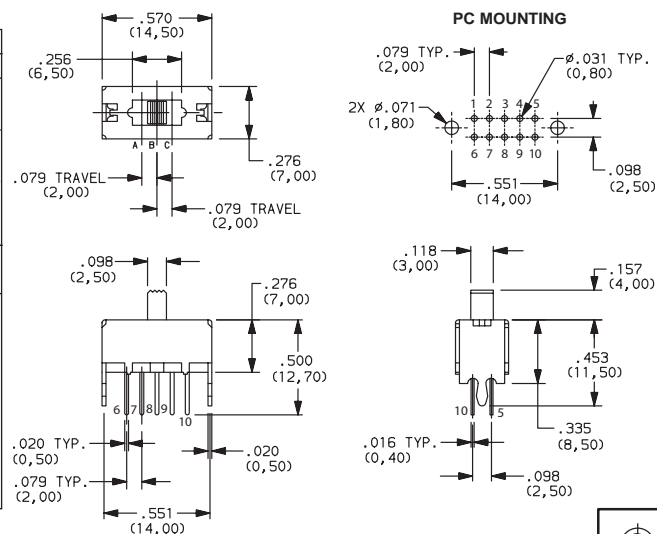

Actuator shown in pos. 2(A)

OS203011MV9QS1  
DP3T



Dimensions are shown: Inches (mm)

Specifications and dimensions subject to change



9 nov 16



# OS Series Miniature Slide Switches

PART NUMBER	RoHS Compliant	RoHS Compatible	SWITCH FUNCTION	
			POS.1	POS.2
OS202011MA0QN1 (Non-shorting)	YES	NO		
OS202011MA0QS1 (Shorting)	YES	NO		
CONN. TERMINALS			1-2, 4-5	2-3, 5-6
SCHEMATIC				
DPDT				

CONTACT RATING: 0.1A @ 12 VDC

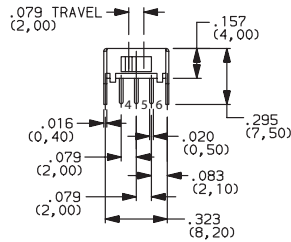
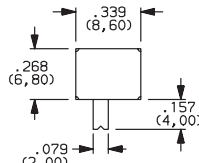

Actuator shown in pos. 1

## PC MOUNTING

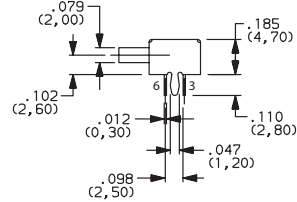
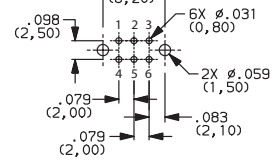

OS202011MA0QN1  
DPDT

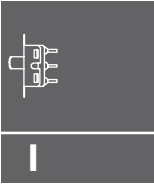

Slide