



Is Now Part of



ON Semiconductor®

To learn more about ON Semiconductor, please visit our website at
www.onsemi.com

ON Semiconductor and the ON Semiconductor logo are trademarks of Semiconductor Components Industries, LLC dba ON Semiconductor or its subsidiaries in the United States and/or other countries. ON Semiconductor owns the rights to a number of patents, trademarks, copyrights, trade secrets, and other intellectual property. A listing of ON Semiconductor's product/patent coverage may be accessed at www.onsemi.com/site/pdf/Patent-Marking.pdf. ON Semiconductor reserves the right to make changes without further notice to any products herein. ON Semiconductor makes no warranty, representation or guarantee regarding the suitability of its products for any particular purpose, nor does ON Semiconductor assume any liability arising out of the application or use of any product or circuit, and specifically disclaims any and all liability, including without limitation special, consequential or incidental damages. Buyer is responsible for its products and applications using ON Semiconductor products, including compliance with all laws, regulations and safety requirements or standards, regardless of any support or applications information provided by ON Semiconductor. "Typical" parameters which may be provided in ON Semiconductor data sheets and/or specifications can and do vary in different applications and actual performance may vary over time. All operating parameters, including "Typicals" must be validated for each customer application by customer's technical experts. ON Semiconductor does not convey any license under its patent rights nor the rights of others. ON Semiconductor products are not designed, intended, or authorized for use as a critical component in life support systems or any FDA Class 3 medical devices or medical devices with a same or similar classification in a foreign jurisdiction or any devices intended for implantation in the human body. Should Buyer purchase or use ON Semiconductor products for any such unintended or unauthorized application, Buyer shall indemnify and hold ON Semiconductor and its officers, employees, subsidiaries, affiliates, and distributors harmless against all claims, costs, damages, and expenses, and reasonable attorney fees arising out of, directly or indirectly, any claim of personal injury or death associated with such unintended or unauthorized use, even if such claim alleges that ON Semiconductor was negligent regarding the design or manufacture of the part. ON Semiconductor is an Equal Opportunity/Affirmative Action Employer. This literature is subject to all applicable copyright laws and is not for resale in any manner.



February 2015

FDME910PZT

P-Channel PowerTrench[®] MOSFET

-20 V, -8 A, 24 mΩ

Features

- Max $r_{DS(on)}$ = 24 mΩ at $V_{GS} = -4.5$ V, $I_D = -8$ A
- Max $r_{DS(on)}$ = 31 mΩ at $V_{GS} = -2.5$ V, $I_D = -7$ A
- Max $r_{DS(on)}$ = 45 mΩ at $V_{GS} = -1.8$ V, $I_D = -6$ A
- Low profile: 0.55 mm maximum in the new package MicroFET 1.6x1.6 Thin
- HBM ESD protection level > 2 kV typical (Note 3)
- Free from halogenated compounds and antimony oxides
- RoHS Compliant



General Description

This device is designed specifically for battery charging or load switching in cellular handset and other ultraportable applications. It features a MOSFET with low on-state resistance and zener diode protection against ESD. The MicroFET 1.6x1.6 Thin package offers exceptional thermal performance for its physical size and is well suited to switching and linear mode applications.

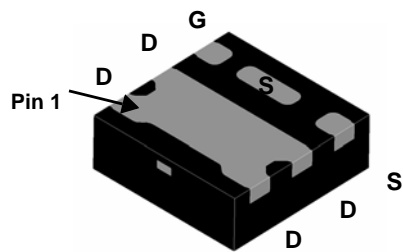

BOTTOM

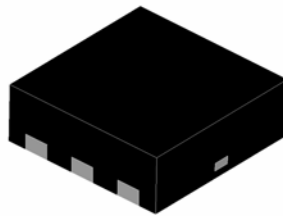

TOP

MicroFET 1.6x1.6 Thin

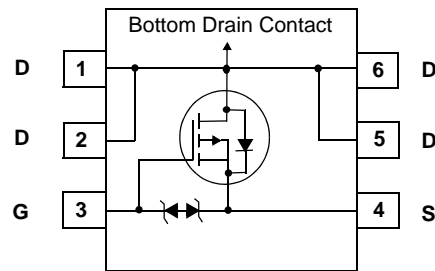

MOSFET Maximum Ratings $T_A = 25$ °C unless otherwise noted

Symbol	Parameter	Ratings	Units
V_{DS}	Drain to Source Voltage	-20	V
V_{GS}	Gate to Source Voltage	±8	V
I_D	-Continuous $T_A = 25^\circ\text{C}$ (Note 1a)	-8	A
	-Pulsed	-32	
P_D	Power Dissipation $T_A = 25^\circ\text{C}$ (Note 1a)	2.1	W
	Power Dissipation $T_A = 25^\circ\text{C}$ (Note 1b)	0.7	
T_J, T_{STG}	Operating and Storage Junction Temperature Range	-55 to +150	°C

Thermal Characteristics

$R_{\theta JA}$	Thermal Resistance, Junction to Ambient	(Note 1a)	60	°C/W
$R_{\theta JA}$	Thermal Resistance, Junction to Ambient	(Note 1a)	175	

Package Marking and Ordering Information

Device Marking	Device	Package	Reel Size	Tape Width	Quantity
E91	FDME910PZT	MicroFET 1.6x1.6 Thin	7"	8 mm	5000 units

FDME910PZT P-Channel PowerTrench[®] MOSFET

Electrical Characteristics $T_J = 25\text{ }^\circ\text{C}$ unless otherwise noted

Symbol	Parameter	Test Conditions	Min	Typ	Max	Units
--------	-----------	-----------------	-----	-----	-----	-------

Off Characteristics

BV_{DSS}	Drain to Source Breakdown Voltage	$I_D = -250\ \mu\text{A}, V_{GS} = 0\ \text{V}$	-20			V
$\frac{\Delta BV_{DSS}}{\Delta T_J}$	Breakdown Voltage Temperature Coefficient	$I_D = -250\ \mu\text{A}$, referenced to $25\text{ }^\circ\text{C}$		-16		mV/ $^\circ\text{C}$
I_{DSS}	Zero Gate Voltage Drain Current	$V_{DS} = -16\ \text{V}, V_{GS} = 0\ \text{V}$			-1	μA
I_{GSS}	Gate to Source Leakage Current	$V_{GS} = \pm 8\ \text{V}, V_{DS} = 0\ \text{V}$			± 10	μA

On Characteristics

$V_{GS(th)}$	Gate to Source Threshold Voltage	$V_{GS} = V_{DS}, I_D = -250\ \mu\text{A}$	-0.4	-0.6	-1.5	V
$\frac{\Delta V_{GS(th)}}{\Delta T_J}$	Gate to Source Threshold Voltage Temperature Coefficient	$I_D = -250\ \mu\text{A}$, referenced to $25\text{ }^\circ\text{C}$		2.7		mV/ $^\circ\text{C}$
$r_{DS(on)}$	Static Drain to Source On Resistance	$V_{GS} = -4.5\ \text{V}, I_D = -8\ \text{A}$		20	24	m Ω
		$V_{GS} = -2.5\ \text{V}, I_D = -7\ \text{A}$		25	31	
		$V_{GS} = -1.8\ \text{V}, I_D = -6\ \text{A}$		32	45	
		$V_{GS} = -4.5\ \text{V}, I_D = -8\ \text{A}, T_J = 125\text{ }^\circ\text{C}$		26	36	
g_{FS}	Forward Transconductance	$V_{DD} = -5\ \text{V}, I_D = -8\ \text{A}$		38		S

Dynamic Characteristics

C_{iss}	Input Capacitance	$V_{DS} = -10\ \text{V}, V_{GS} = 0\ \text{V},$ $f = 1\ \text{MHz}$		1586	2110	pF
C_{oss}	Output Capacitance			236	355	pF
C_{rss}	Reverse Transfer Capacitance			218	330	pF

Switching Characteristics

$t_{d(on)}$	Turn-On Delay Time	$V_{DD} = -10\ \text{V}, I_D = -8\ \text{A},$ $V_{GS} = -4.5\ \text{V}, R_{GEN} = 6\ \Omega$		9	18	ns
t_r	Rise Time			11	20	ns
$t_{d(off)}$	Turn-Off Delay Time			87	139	ns
t_f	Fall Time			46	74	ns
Q_g	Total Gate Charge		$V_{GS} = -4.5\ \text{V}, V_{DD} = -10\ \text{V},$ $I_D = -8\ \text{A}$		15	21
Q_{gs}	Gate to Source Charge			2.2		nC
Q_{gd}	Gate to Drain "Miller" Charge			3.6		nC

Drain-Source Diode Characteristics

V_{SD}	Source to Drain Diode Forward Voltage	$V_{GS} = 0\ \text{V}, I_S = -8\ \text{A}$ (Note 2)	-0.57	-0.8	-1.2	V
		$V_{GS} = 0\ \text{V}, I_S = -1.8\ \text{A}$ (Note 2)		-0.7	-1.2	V
t_{rr}	Reverse Recovery Time	$I_F = -8\ \text{A}, di/dt = 100\ \text{A}/\mu\text{s}$		17	31	ns
Q_{rr}	Reverse Recovery Charge			4.1	10	nC

Notes:

1. $R_{\theta JA}$ is determined with the device mounted on a $1\ \text{in}^2$ pad 2 oz copper pad on a $1.5 \times 1.5\ \text{in.}$ board of FR-4 material. $R_{\theta JC}$ is guaranteed by design while $R_{\theta CA}$ is determined by the user's board design.



a. $60\text{ }^\circ\text{C}/\text{W}$ when mounted on a $1\ \text{in}^2$ pad of 2 oz copper.



b. $175\text{ }^\circ\text{C}/\text{W}$ when mounted on a minimum pad of 2 oz copper.

2. Pulse Test: Pulse Width < $300\ \mu\text{s}$, Duty cycle < 2.0% .

3. The diode connected between the gate and source serves only as protection ESD. No gate overvoltage rating is implied.

Typical Characteristics $T_J = 25\text{ }^\circ\text{C}$ unless otherwise noted

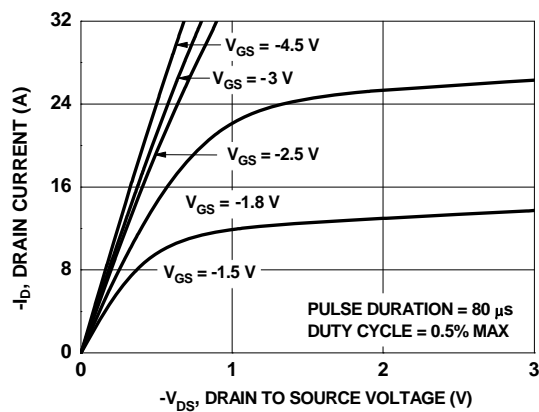

Figure 1. On Region Characteristics

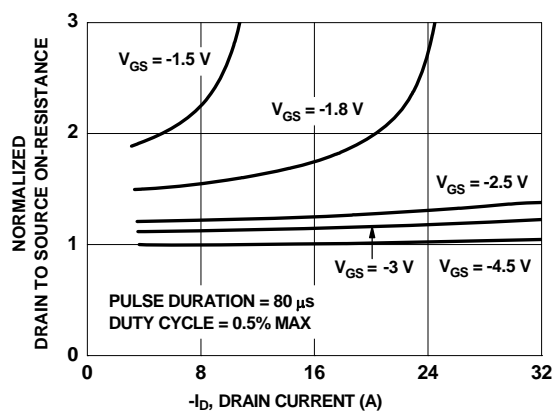

Figure 2. Normalized On-Resistance vs Drain Current and Gate Voltage

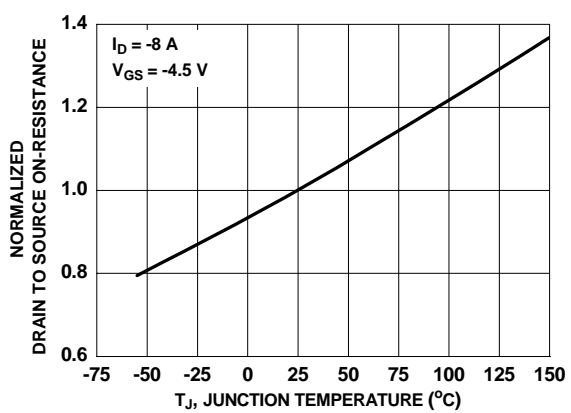

Figure 3. Normalized On Resistance vs Junction Temperature

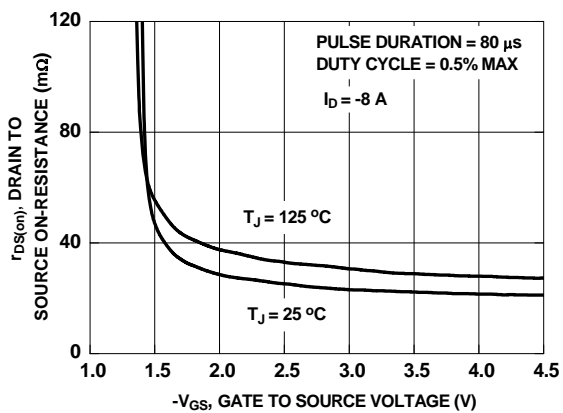

Figure 4. On-Resistance vs Gate to Source Voltage

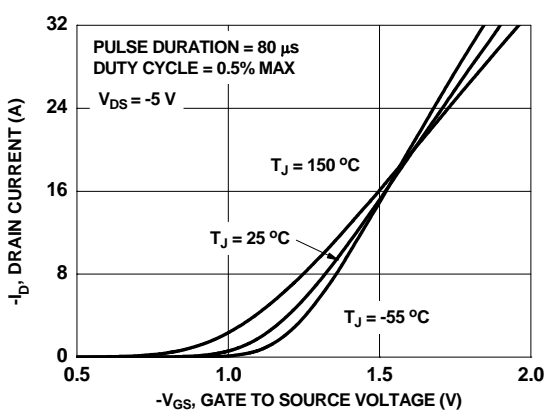

Figure 5. Transfer Characteristics

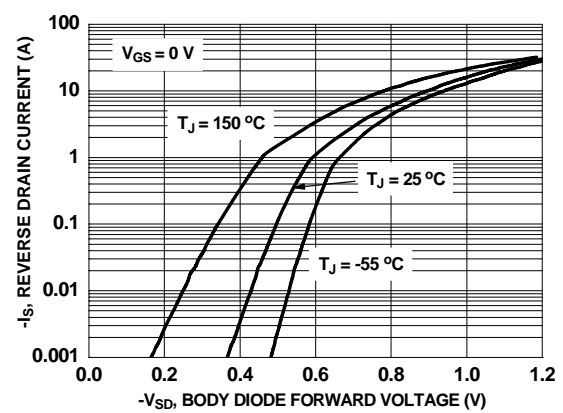

Figure 6. Source to Drain Diode Forward Voltage vs Source Current

Typical Characteristics $T_J = 25\text{ }^\circ\text{C}$ unless otherwise noted

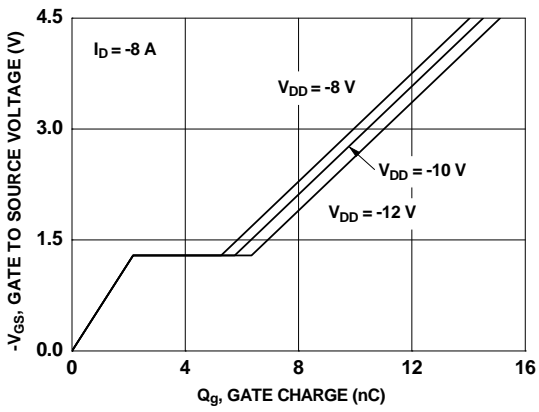

Figure 7. Gate Charge Characteristics

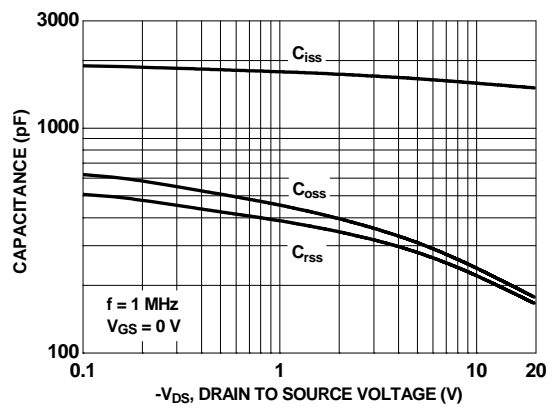

Figure 8. Capacitance vs Drain to Source Voltage

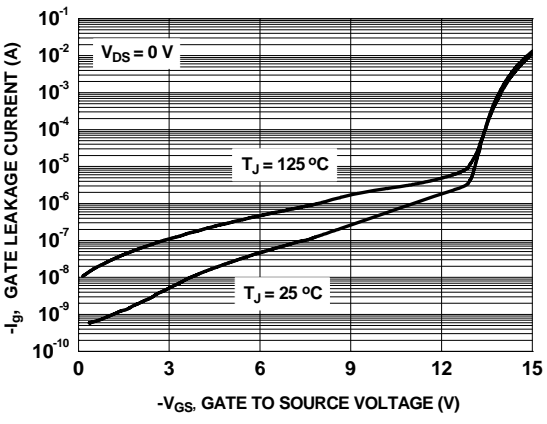

Figure 9. Gate Leakage Current vs Gate to Source Voltage

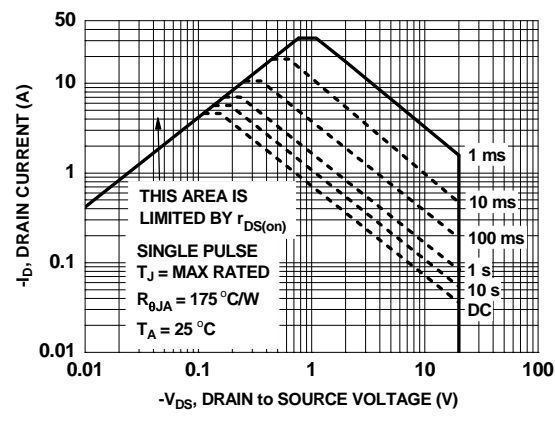

Figure 10. Forward Bias Safe Operating Area

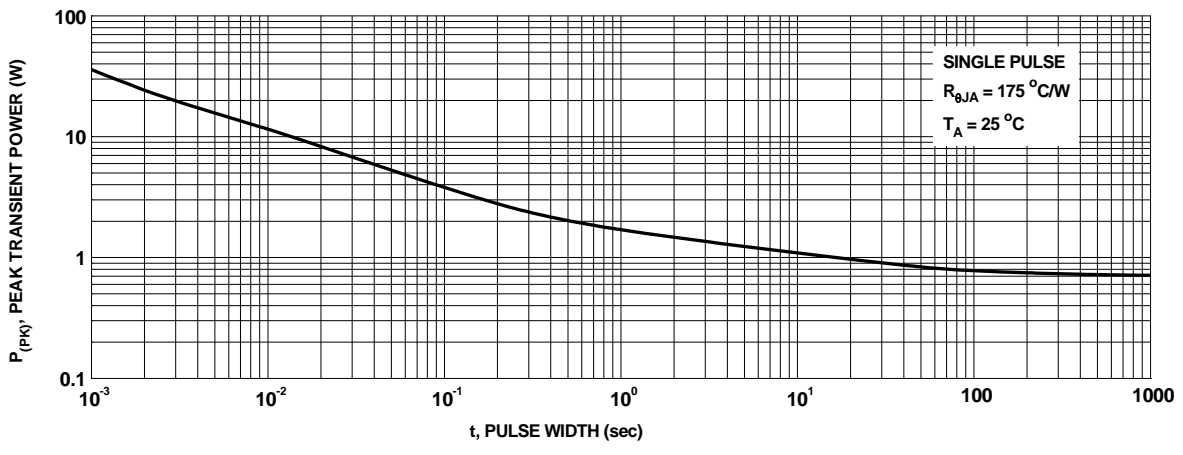

Figure 11. Single Pulse Maximum Power Dissipation

Typical Characteristics $T_J = 25\text{ }^\circ\text{C}$ unless otherwise noted

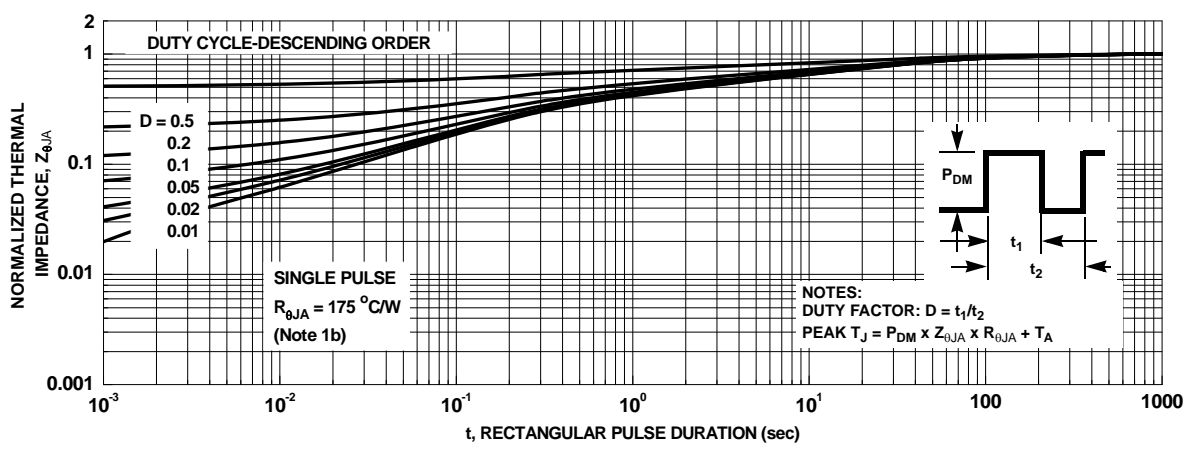
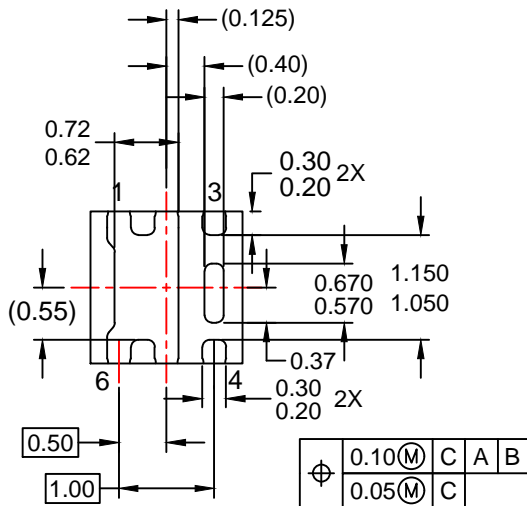
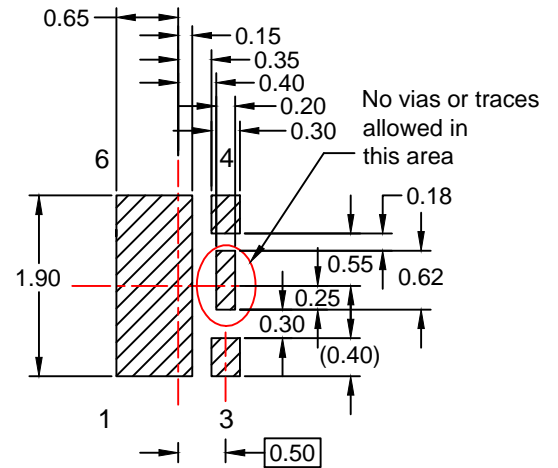
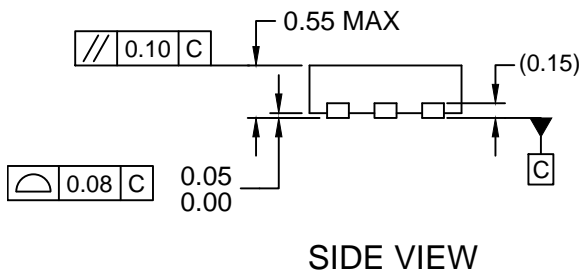
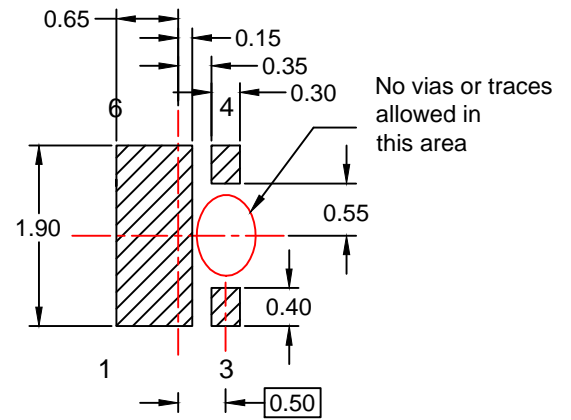
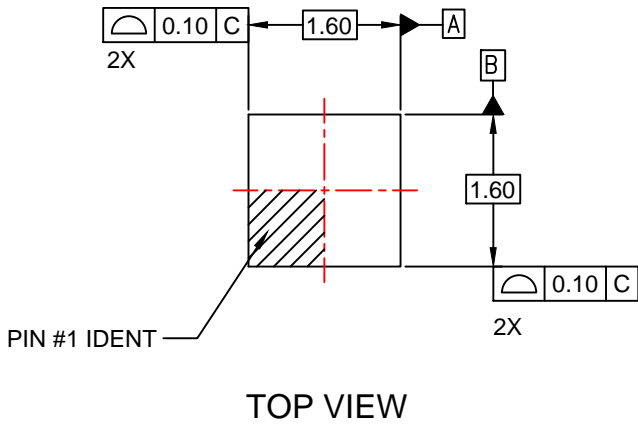

Figure 12. Junction-to-Ambient Transient Thermal Response Curve



- NOTES:**
- A. DOES NOT FULLY CONFORM TO JEDEC REGISTRATION
 - B. DIMENSIONS ARE IN MILLIMETERS.
 - C. DIMENSIONS AND TOLERANCES PER ASME Y14.5M, 1994.
 - D. LAND PATTERN RECOMMENDATION IS BASED ON FSC DESIGN ONLY
 - E. DRAWING FILENAME: MKT-UMLP06Frev6

ON Semiconductor and  are trademarks of Semiconductor Components Industries, LLC dba ON Semiconductor or its subsidiaries in the United States and/or other countries. ON Semiconductor owns the rights to a number of patents, trademarks, copyrights, trade secrets, and other intellectual property. A listing of ON Semiconductor's product/patent coverage may be accessed at www.onsemi.com/site/pdf/Patent-Marking.pdf. ON Semiconductor reserves the right to make changes without further notice to any products herein. ON Semiconductor makes no warranty, representation or guarantee regarding the suitability of its products for any particular purpose, nor does ON Semiconductor assume any liability arising out of the application or use of any product or circuit, and specifically disclaims any and all liability, including without limitation special, consequential or incidental damages. Buyer is responsible for its products and applications using ON Semiconductor products, including compliance with all laws, regulations and safety requirements or standards, regardless of any support or applications information provided by ON Semiconductor. "Typical" parameters which may be provided in ON Semiconductor data sheets and/or specifications can and do vary in different applications and actual performance may vary over time. All operating parameters, including "Typicals" must be validated for each customer application by customer's technical experts. ON Semiconductor does not convey any license under its patent rights nor the rights of others. ON Semiconductor products are not designed, intended, or authorized for use as a critical component in life support systems or any FDA Class 3 medical devices or medical devices with a same or similar classification in a foreign jurisdiction or any devices intended for implantation in the human body. Should Buyer purchase or use ON Semiconductor products for any such unintended or unauthorized application, Buyer shall indemnify and hold ON Semiconductor and its officers, employees, subsidiaries, affiliates, and distributors harmless against all claims, costs, damages, and expenses, and reasonable attorney fees arising out of, directly or indirectly, any claim of personal injury or death associated with such unintended or unauthorized use, even if such claim alleges that ON Semiconductor was negligent regarding the design or manufacture of the part. ON Semiconductor is an Equal Opportunity/Affirmative Action Employer. This literature is subject to all applicable copyright laws and is not for resale in any manner.

PUBLICATION ORDERING INFORMATION

LITERATURE FULFILLMENT:

Literature Distribution Center for ON Semiconductor
19521 E. 32nd Pkwy, Aurora, Colorado 80011 USA
Phone: 303-675-2175 or 800-344-3860 Toll Free USA/Canada
Fax: 303-675-2176 or 800-344-3867 Toll Free USA/Canada
Email: orderlit@onsemi.com

N. American Technical Support: 800-282-9855 Toll Free
USA/Canada
Europe, Middle East and Africa Technical Support:
Phone: 421 33 790 2910
Japan Customer Focus Center
Phone: 81-3-5817-1050

ON Semiconductor Website: www.onsemi.com
Order Literature: <http://www.onsemi.com/orderlit>
For additional information, please contact your local
Sales Representative