

# Analog Devices Welcomes Hittite Microwave Corporation

NO CONTENT ON THE ATTACHED DOCUMENT HAS CHANGED



# HMC408\* Product Page Quick Links

Last Content Update: 11/01/2016

---

## [Comparable Parts](#)

View a parametric search of comparable parts

## [Evaluation Kits](#)

- HMC408LP3 Evaluation Board

## [Documentation](#)

### **Application Notes**

- AN-1363: Meeting Biasing Requirements of Externally Biased RF/Microwave Amplifiers with Active Bias Controllers
- Broadband Biasing of Amplifiers General Application Note
- MMIC Amplifier Biasing Procedure Application Note
- Thermal Management for Surface Mount Components General Application Note

### **Data Sheet**

- HMC408 Data Sheet

## [Tools and Simulations](#)

- HMC408 S-Parameter

## [Reference Materials](#)

### **Quality Documentation**

- Package/Assembly Qualification Test Report: 16L 3x3mm QFN Package (QTR: 11003 REV: 02)
- Package/Assembly Qualification Test Report: LP2, LP2C, LP3, LP3B, LP3C, LP3D, LP3F, LP3G (QTR: 2014-0364)
- Package/Assembly Qualification Test Report: Plastic Encapsulated QFN (QTR: 05006 REV: 02)
- Semiconductor Qualification Test Report: GaAs HBT-B (QTR: 2013-00229)

## [Design Resources](#)

- HMC408 Material Declaration
- PCN-PDN Information
- Quality And Reliability
- Symbols and Footprints

## [Discussions](#)

View all HMC408 EngineerZone Discussions

## [Sample and Buy](#)

Visit the product page to see pricing options

## [Technical Support](#)

Submit a technical question or find your regional support number

**THIS PAGE INTENTIONALLY LEFT BLANK**



## GaAs InGaP HBT MMIC 1 WATT POWER AMPLIFIER, 5.1 - 5.9 GHz

### Typical Applications

The HMC408LP3 / HMC408LP3E is ideal for:

- 802.11a & HiperLAN WLAN
- UNII & Point-to-Point / Multi-Point Radios
- Access Point Radios

### Features

- Gain: 20 dB
- Saturated Power: +32.5 dBm @ 27% PAE
- Single Supply Voltage: +5V
- Power Down Capability
- 3x3 mm Leadless SMT Package

### Functional Diagram

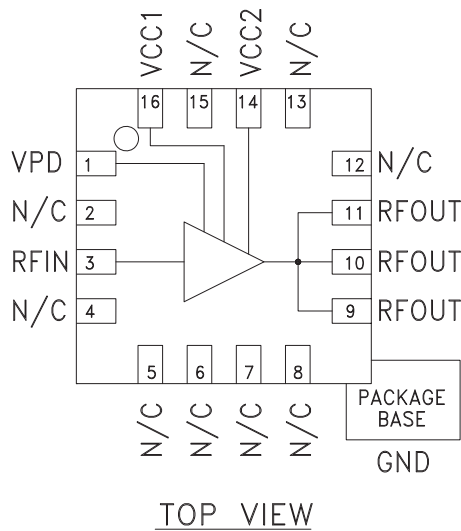

### General Description

The HMC408LP3 & HMC408LP3E are 5.1 - 5.9 GHz high efficiency GaAs InGaP Heterojunction Bipolar Transistor (HBT) Power Amplifier MMICs which offer +30 dBm P1dB. The amplifier provides 20 dB of gain, +32.5 dBm of saturated power, and 27% PAE from a +5V supply voltage. The input is internally matched to 50 Ohms while the output requires a minimum of external components. Vpd can be used for full power down or RF output power/current control. The amplifier is packaged in a low cost, 3x3 mm leadless surface mount package with an exposed base for improved RF and thermal performance.

### Electrical Specifications, $T_A = +25^\circ C$ , $V_s = 5V$ , $V_{pd} = 5V$

Parameter	Min.	Typ.	Max.	Min.	Typ.	Max.	Units
Frequency Range	5.7 - 5.9			5.1 - 5.9			GHz
Gain	17	20		17	20		dB
Gain Variation Over Temperature		0.045	0.055		0.045	0.055	dB/°C
Input Return Loss		8			8		dB
Output Return Loss*		14			6		dB
Output Power for 1 dB Compression (P1dB)	Icq= 750 mA Icq= 500 mA	27 30	27	24	27 23		dBm
Saturated Output Power (P <sub>sat</sub> )		32.5			31		dBm
Output Third Order Intercept (IP3)	40	43		36	39		dBm
Harmonics, P <sub>out</sub> = 30 dBm, F= 5.8 GHz	2 fo 3 fo	-50 -90			-50 -90		dBc dBc
Noise Figure		6			6		dB
Supply Current (I <sub>cq</sub> )	V <sub>pd</sub> = 0V/5V	0.002 / 750			0.002 / 750		mA
Control Current (I <sub>pd</sub> )	V <sub>pd</sub> = 5V	14			14		mA
Switching Speed	t <sub>On</sub> , t <sub>Off</sub>	50			50		ns

\* Output match optimized for 5.7 - 5.9 GHz operation. See Application Circuit herein.



**Broadband Gain & Return Loss**

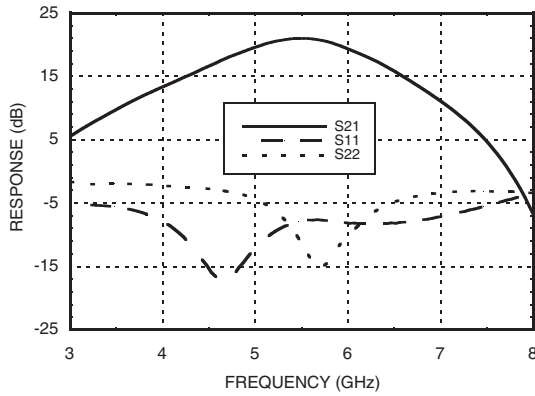

**Gain vs. Temperature**

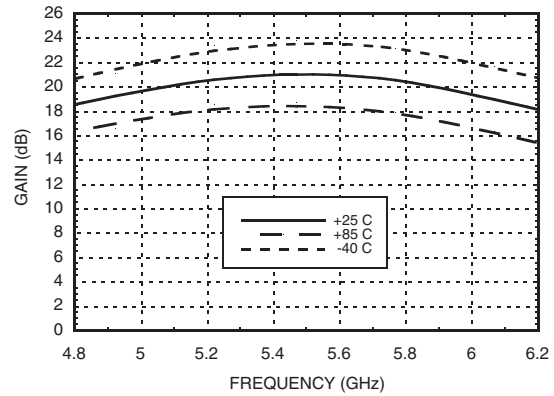

**Input Return Loss vs. Temperature**

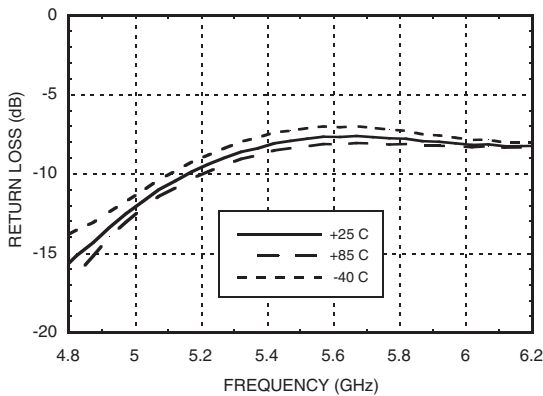

**Output Return Loss vs. Temperature\***

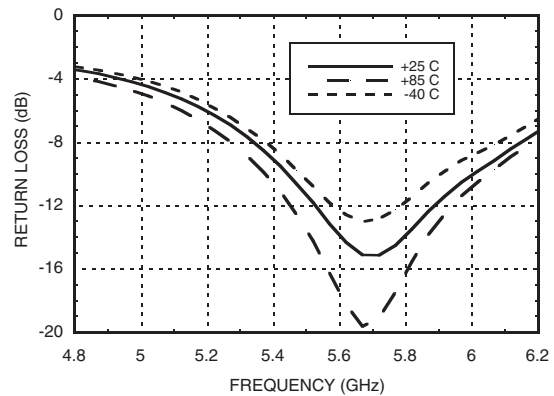

**P1dB vs. Temperature**

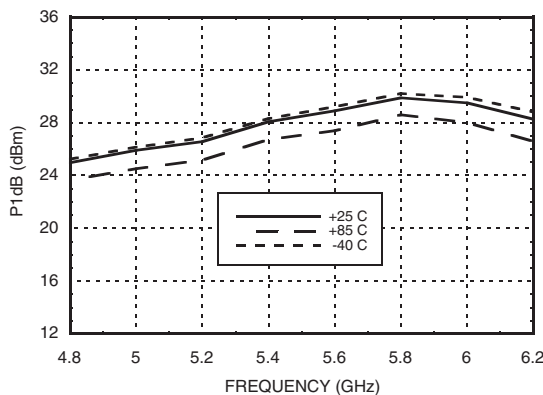

**Psat vs. Temperature**

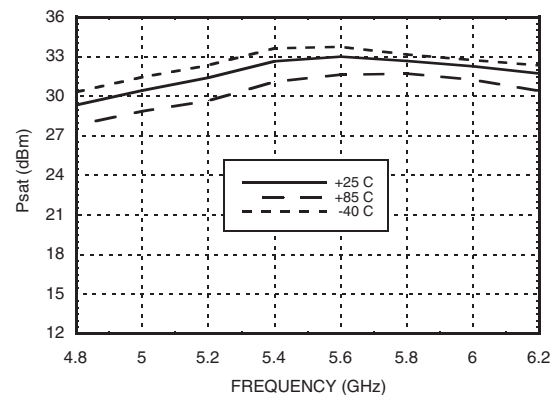

\* Output match optimized for 5.7 - 5.9 GHz.



# HMC408LP3 / 408LP3E

## GaAs InGaP HBT MMIC 1 WATT POWER AMPLIFIER, 5.1 - 5.9 GHz

### Power Compression @ 5.8 GHz

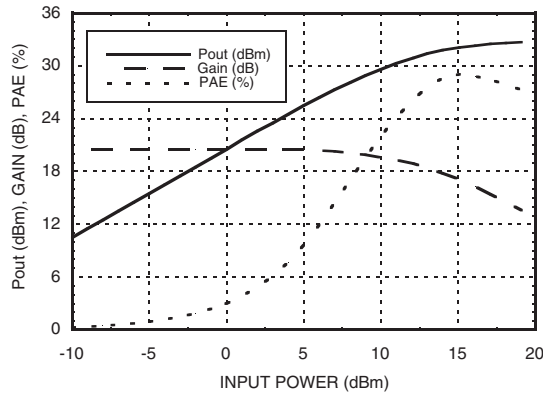

### Output IP3 vs. Temperature

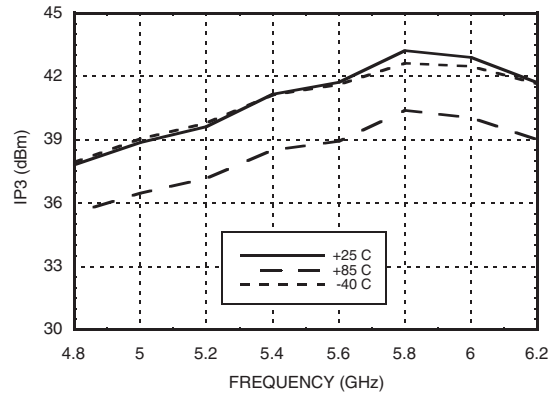

### Noise Figure vs. Temperature

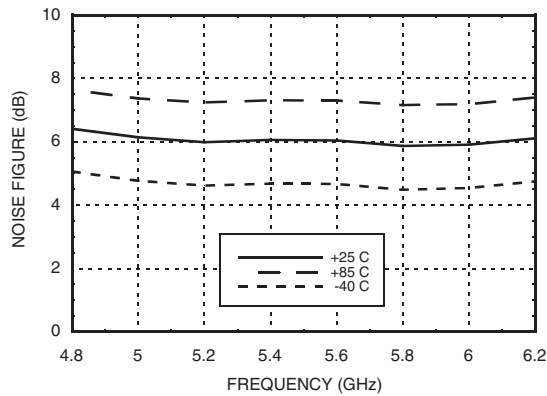

### Gain & Power vs. Supply Voltage @ 5.8 GHz

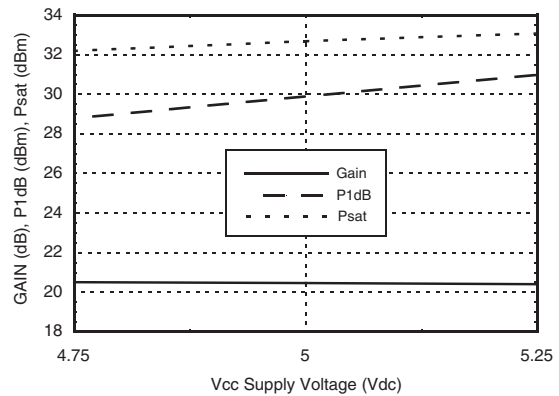

### Reverse Isolation vs. Temperature

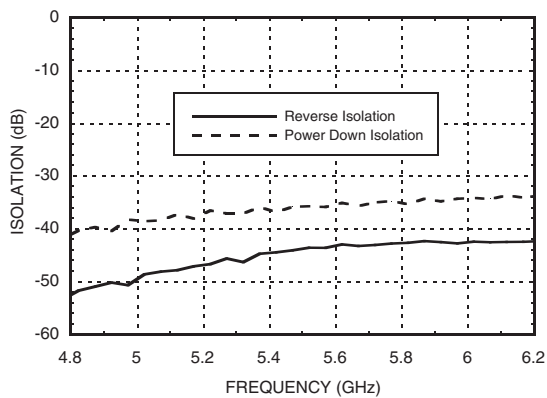

### Gain, Power & Quiescent Supply Current vs. Vpd @ 5.8 GHz

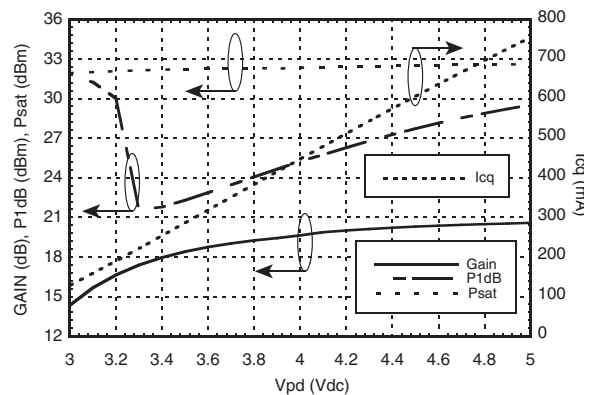

### Typical Supply Current vs. Vs= Vcc1 + Vcc2

Vs (V)	Icq (mA)
4.75	725
5.0	750
5.25	780

Note: Amplifier will operate over full voltage range shown above

### Absolute Maximum Ratings

Collector Bias Voltage (Vcc1, Vcc2)	+5.5 Vdc
Control Voltage (Vpd)	+5.5 Vdc
RF Input Power (RFIN)(Vs = Vpd = +5Vdc)	+20 dBm
Junction Temperature	150 °C
Continuous Pdiss (T = 85 °C) (derate 72.5 mW/°C above 85 °C)	4.71 W
Thermal Resistance (junction to ground paddle)	13.8 °C/W
Storage Temperature	-65 to +150 °C
Operating Temperature	-40 to +85 °C



ELECTROSTATIC SENSITIVE DEVICE  
OBSERVE HANDLING PRECAUTIONS

11

### Outline Drawing

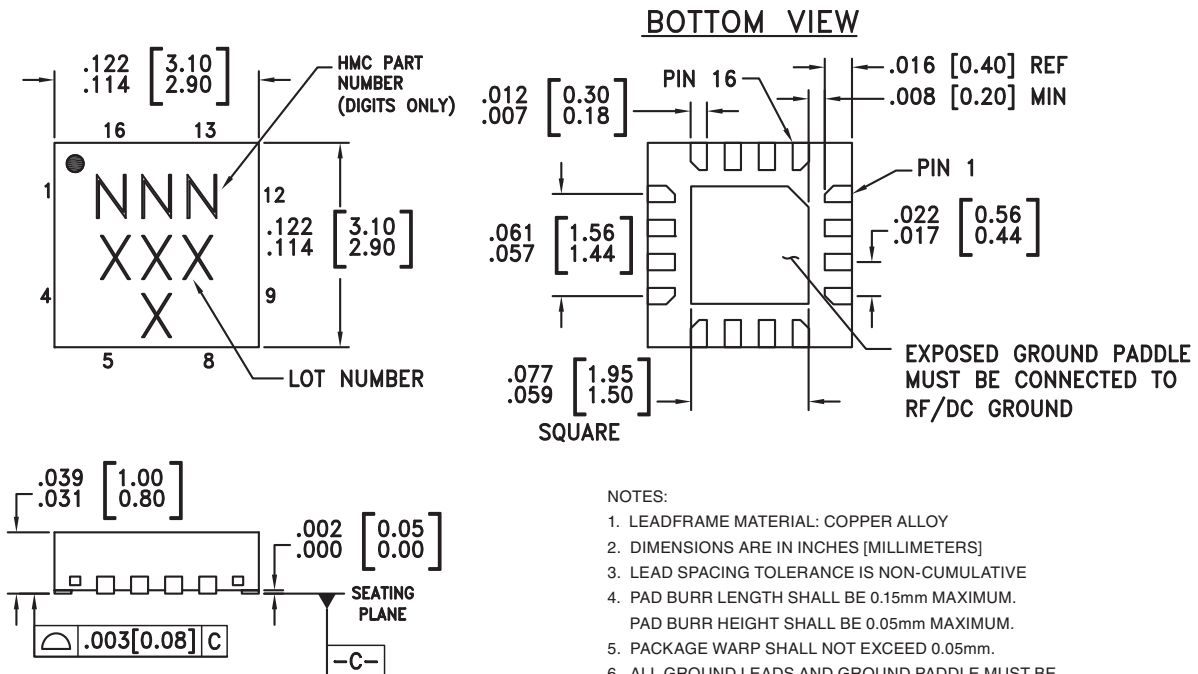

NOTES:

- LEADFRAME MATERIAL: COPPER ALLOY
- DIMENSIONS ARE IN INCHES [MILLIMETERS]
- LEAD SPACING TOLERANCE IS NON-CUMULATIVE
- PAD BURR LENGTH SHALL BE 0.15mm MAXIMUM.  
PAD BURR HEIGHT SHALL BE 0.05mm MAXIMUM.
- PACKAGE WARP SHALL NOT EXCEED 0.05mm.
- ALL GROUND LEADS AND GROUND PADDLE MUST BE SOLDERED TO PCB RF GROUND.
- REFER TO HITTITE APPLICATION NOTE FOR SUGGESTED LAND PATTERN.

### Package Information

Part Number	Package Body Material	Lead Finish	MSL Rating	Package Marking <sup>[3]</sup>
HMC408LP3	Low Stress Injection Molded Plastic	Sn/Pb Solder	MSL1 <sup>[1]</sup>	408 XXXX
HMC408LP3E	RoHS-compliant Low Stress Injection Molded Plastic	100% matte Sn	MSL1 <sup>[2]</sup>	408 XXXX



[1] Max peak reflow temperature of 235 °C

[2] Max peak reflow temperature of 260 °C

[3] 4-Digit lot number XXXX

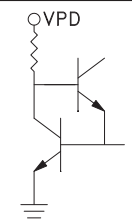
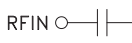
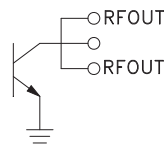
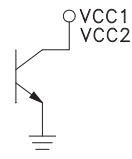

### Pin Descriptions

Pin Number	Function	Description	Interface Schematic
1	Vpd	Power control pin. For maximum power, this pin should be connected to 5V. A higher voltage is not recommended. For lower idle current, this voltage can be reduced.	
2, 4, 5 - 8, 12, 13, 15	N/C	No Connection	
3	RFIN	This pin AC coupled and matched to 50 Ohms.	
9, 10, 11	RFOUT	RF output and DC bias for the output stage.	
14	Vcc2	Power supply voltage for the second amplifier stage. External bypass capacitors and pull up choke are required as shown in the application schematic.	
16	Vcc1	Power supply voltage for the first amplifier stage. External bypass capacitors are required as shown in the application schematic.	
	GND	Ground: Backside of package has exposed metal ground slug that must be connected to ground thru a short path. Vias under the device are required.	



### Evaluation PCB

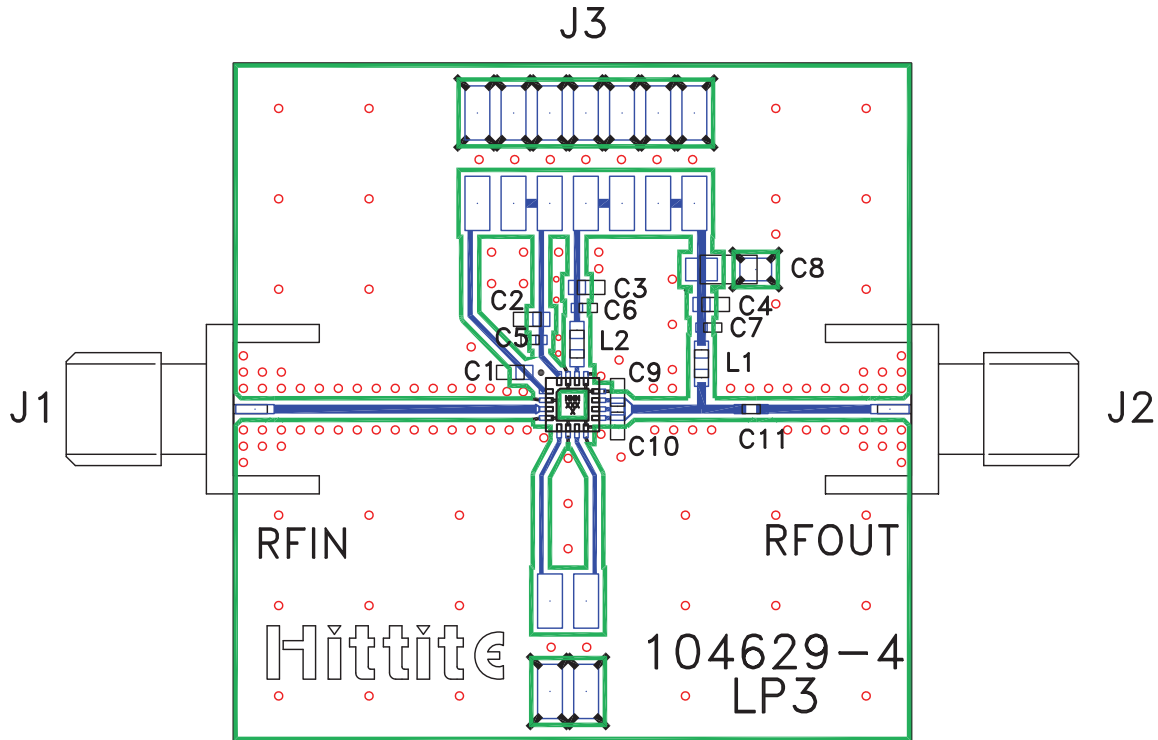

### List of Materials for Evaluation PCB 105180 [1]

Item	Description
J1 - J2	PCB Mount SMA RF Connector
J3	2 mm DC Header
C1 - C4	1,000 pF Capacitor, 0603 Pkg.
C5 - C7	100 pF Capacitor, 0402 Pkg.
C8	2.2 $\mu$ F Tantalum Capacitor
C9 - C10	0.5 pF Capacitor, 0603 Pkg.
C11	10 pF Capacitor, 0402 Pkg.
L1 - L2	1.6 nH Inductor, 0603 Pkg.
U1	HMC408LP3 / HMC408LP3E Amplifier
PCB [2]	104629 Eval Board

[1] Reference this number when ordering complete evaluation PCB

[2] Circuit Board Material: Rogers 4350

The circuit board used in the final application should use RF circuit design techniques. Signal lines should have 50 ohm impedance while the package ground leads and exposed paddle should be connected directly to the ground plane similar to that shown. A sufficient number of via holes should be used to connect the top and bottom ground planes. The evaluation board should be mounted to an appropriate heat sink. The evaluation circuit board shown is available from Hittite upon request.

### Application Circuit

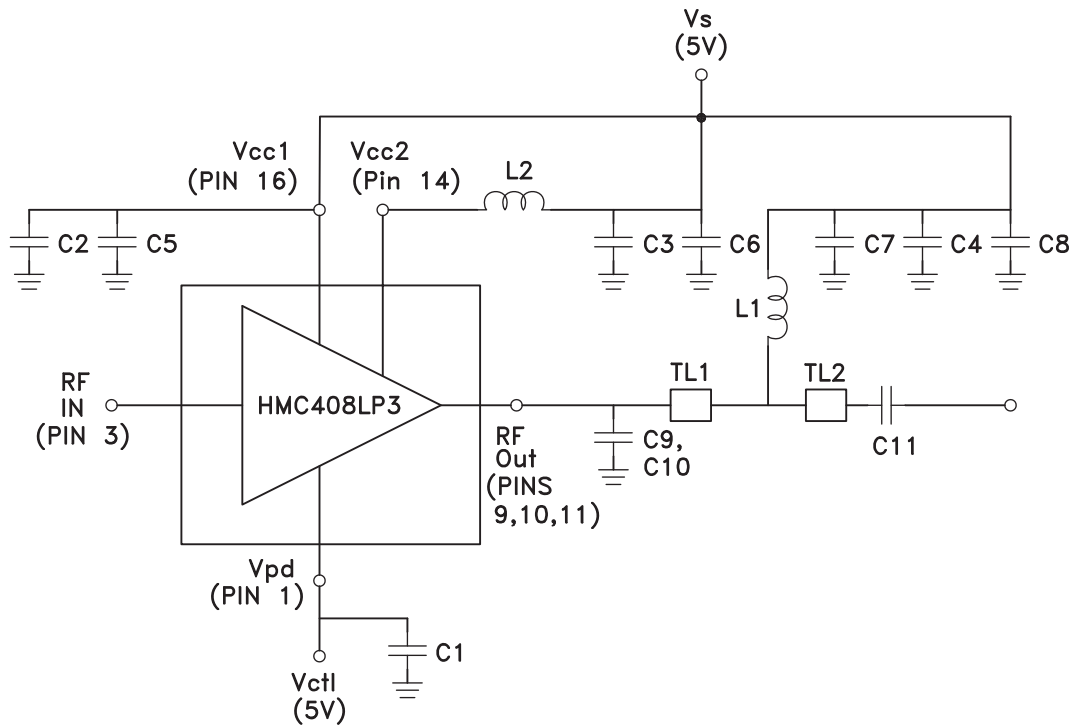

Recommended Component Values	
L1, L2	1.6 nH
C1 - C4	1,000 pF
C5 - C7	100 pF
C8	2.2 $\mu$ F
C9 - C10	0.5 pF

	TL1	TL2
Impedance	50 Ohm	50 Ohm
Length	0.200"	0.100"

Note 1: C9, C10 should be located < 0.020" from pins 9, 10, & 11.

Note 2: Application circuit values shown are optimized for 5.7 - 5.9 GHz operation.

Contact our Applications Engineers for optimization of output match for other frequencies.



**Notes:**