



Is Now Part of



ON Semiconductor®

To learn more about ON Semiconductor, please visit our website at
www.onsemi.com

ON Semiconductor and the ON Semiconductor logo are trademarks of Semiconductor Components Industries, LLC dba ON Semiconductor or its subsidiaries in the United States and/or other countries. ON Semiconductor owns the rights to a number of patents, trademarks, copyrights, trade secrets, and other intellectual property. A listing of ON Semiconductor's product/patent coverage may be accessed at www.onsemi.com/site/pdf/Patent-Marking.pdf. ON Semiconductor reserves the right to make changes without further notice to any products herein. ON Semiconductor makes no warranty, representation or guarantee regarding the suitability of its products for any particular purpose, nor does ON Semiconductor assume any liability arising out of the application or use of any product or circuit, and specifically disclaims any and all liability, including without limitation special, consequential or incidental damages. Buyer is responsible for its products and applications using ON Semiconductor products, including compliance with all laws, regulations and safety requirements or standards, regardless of any support or applications information provided by ON Semiconductor. "Typical" parameters which may be provided in ON Semiconductor data sheets and/or specifications can and do vary in different applications and actual performance may vary over time. All operating parameters, including "Typicals" must be validated for each customer application by customer's technical experts. ON Semiconductor does not convey any license under its patent rights nor the rights of others. ON Semiconductor products are not designed, intended, or authorized for use as a critical component in life support systems or any FDA Class 3 medical devices or medical devices with a same or similar classification in a foreign jurisdiction or any devices intended for implantation in the human body. Should Buyer purchase or use ON Semiconductor products for any such unintended or unauthorized application, Buyer shall indemnify and hold ON Semiconductor and its officers, employees, subsidiaries, affiliates, and distributors harmless against all claims, costs, damages, and expenses, and reasonable attorney fees arising out of, directly or indirectly, any claim of personal injury or death associated with such unintended or unauthorized use, even if such claim alleges that ON Semiconductor was negligent regarding the design or manufacture of the part. ON Semiconductor is an Equal Opportunity/Affirmative Action Employer. This literature is subject to all applicable copyright laws and is not for resale in any manner.

FPF2174 IntelliMAX™ Advanced Load Management Products

Features

- 1.8 to 5.5V Input Voltage Range
- Controlled Turn-On
- 200mA Current Limit Option
- Undervoltage Lockout
- Thermal Shutdown
- $1\mu\text{A}$ Shutdown Current
- Fast Current limit Response Time
 - 3 μs to Moderate Over Currents
 - 20ns to Hard Shorts
- Integrated very low V_F Schottky Diode for Reverse Current Blocking
- Integrated Zener Diode for Output Clamp
- RoHS Compliant

Applications

- PDAs
- Cell Phones
- GPS Devices
- MP3 Players
- Digital Cameras
- Peripheral Ports
- Hot Swap Supplies



General Description

The FPF2174 is a load switch which combines the functionality of the IntelliMAX™ series load switch with a very low forward voltage drop Schottky barrier rectifier and a zener clamp at the output. The integrated solution provides full protection to systems and loads which may encounter large current conditions in a very compact MLP 3x3 package. This device contains a 0.125 Ω current-limited P-channel MOSFET which can operate over an input voltage range of 1.8-5.5V. The Schottky diode acts as a barrier so that no reverse current can flow when the MOSFET is off and the output voltage is higher than the input voltage. Switch control is by a logic input (ON) capable of interfacing directly with low voltage control signals. Each part contains thermal shutdown protection which shuts off the switch to prevent damage to the part when a continuous over-current condition causes excessive heating.

When the switch current reaches the current limit, the part operates in a constant-current mode to prohibit excessive currents from causing damage. If the constant current condition still persists after 10ms, these parts will shut off the switch and pull the fault signal pin (FLAGB) low. The switch will remain off until the ON pin is cycled. The minimum current limit is 200mA.

These parts are available in a space-saving 6L MLP 3x3 package.

Typical Application Circuit

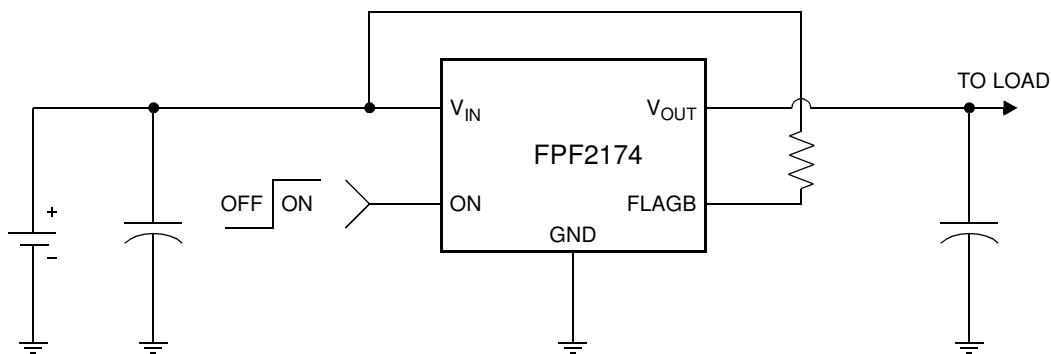

Ordering Information

Part	Current Limit Min [mA]	Current Limit Blanking Time Typ [ms]	Auto-Restart Time [ms]	ON Pin Activity	Top Mark
FPF2174	200	10	NA	Active HI	2174

Functional Block Diagram

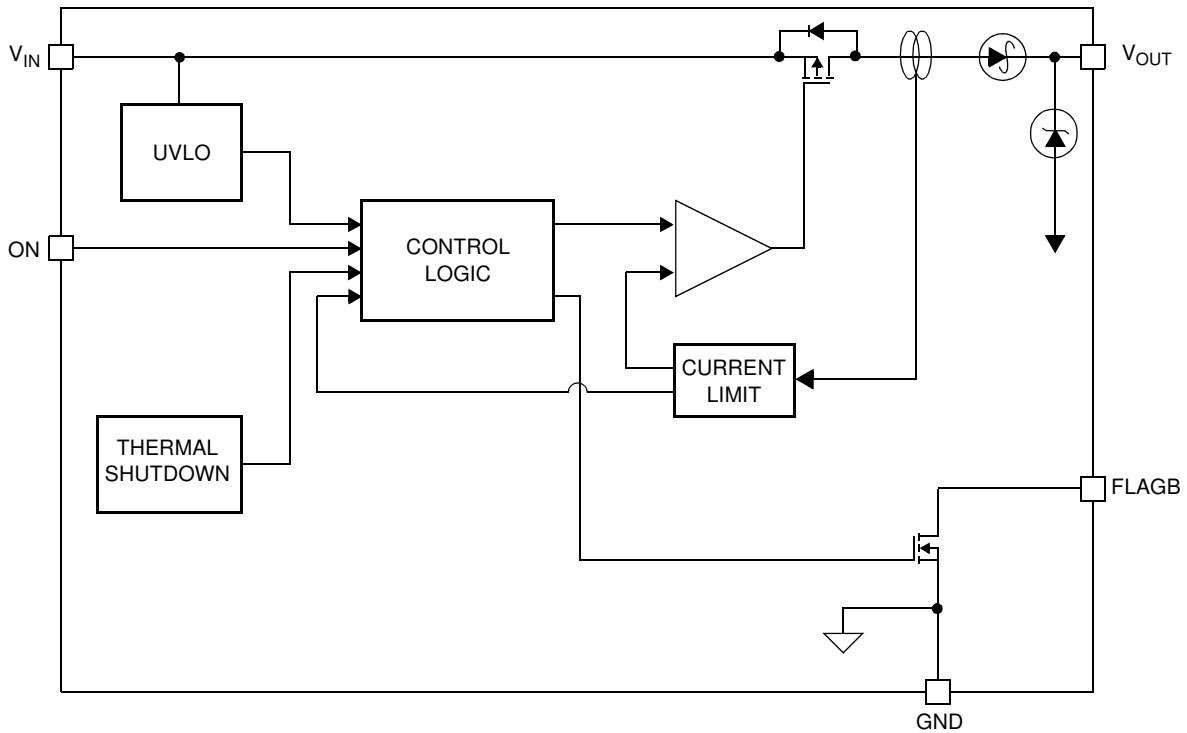

Pin Configuration

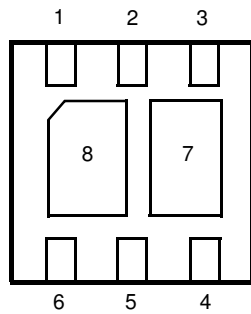

3x3 MLP BOTTOM VIEW

Pin Description

Pin	Name	Function
1	V_{IN}	Supply Input: Input to the power switch and the supply voltage for the IC
2	NC	No Connect
3, 7	V_{OUT}	Switch Output: Output of the power switch
4	GND	Ground
5	FLAGB	Fault Output: Active LO, open drain output which indicates an over current supply, under voltage or over temperature state.
6	ON	ON Control Input
8	PAD1	IC substrate. Can be connected to GND. Do not connect to other pins.

Absolute Maximum Ratings

Parameter	Min	Max	Unit
V_{IN} , ON, FLAGB to GND	-0.3	6	V
V_{OUT} to GND	-0.3	20	V
Power Dissipation @ $T_A = 25^\circ\text{C}$ (note 1)	-	1.4	W
Operating Temperature Range	-40	85	$^\circ\text{C}$
Storage Temperature	-65	150	$^\circ\text{C}$
Thermal Resistance, Junction to Ambient	-	70	$^\circ\text{C}/\text{W}$
Electrostatic Discharge Protection	HBM	4000	V
	MM	400	V

Recommended Operating Range

Parameter	Min	Max	Unit
V_{IN}	1.8	5.5	V
Ambient Operating Temperature, T_A	-40	85	$^\circ\text{C}$

Electrical Characteristics

$V_{IN} = 1.8$ to 5.5V , $T_A = -40$ to $+85^\circ\text{C}$ unless otherwise noted. Typical values are at $V_{IN} = 3.3\text{V}$ and $T_A = 25^\circ\text{C}$.

Parameter	Symbol	Conditions	Min	Typ	Max	Units	
Basic Operation							
Operating Voltage	V_{IN}		1.8	-	5.5	V	
Quiescent Current	I_Q	$I_{OUT} = 0\text{mA}$ V_{ON} ACTIVE	$V_{IN} = 1.8$ to 3.3V	-	95	-	μA
			$V_{IN} = 3.3$ to 5.5V	-	110	200	
Shutdown Current	I_{SHDN}	$V_{ON} = 0\text{V}$, $I_{OUT} = 0\text{mA}$	-	-	1	μA	
Latch-off Current	$I_{LATCHOFF}$	$V_{ON} = V_{IN}$, after an overcurrent fault	-	50	-	μA	
Reverse Block Leakage Current	I_R	$V_{OUT} = 12\text{V}$, $V_{IN} = V_{ON} = 0\text{V}$, $T_A = 25^\circ\text{C}$	-	-	10	μA	
Reverse Breakdown Voltage		$I_{OUT} = 1\text{mA}$	-	15	-	V	
Dropout Voltage	V_{DROP}	$T_A = 25^\circ\text{C}$, $I_{OUT} = 150\text{mA}$	-	0.3	0.4	V	
		$T_A = 85^\circ\text{C}$, $I_{OUT} = 150\text{mA}$	-	0.23	-		
		$T_A = -40^\circ\text{C}$, $I_{OUT} = 150\text{mA}$	-	0.36	-		
ON Input Logic High Voltage (ON)	V_{IH}	$V_{IN} = 1.8\text{V}$	0.75	-	-	V	
		$V_{IN} = 5.5\text{V}$	1.3	-	-		
ON Input Logic Low Voltage	V_{IL}	$V_{IN} = 1.8\text{V}$	-	-	0.5	V	
		$V_{IN} = 5.5\text{V}$	-	-	1.0		
ON Input Leakage		$V_{ON} = V_{IN}$ or GND	-	-	1	μA	
Off Switch Leakage	I_{SWOFF}	$V_{ON} = 0\text{V}$, $V_{OUT} = 0\text{V}$ @ $V_{IN} = 5.5\text{V}$, $T_A = 85^\circ\text{C}$			1	μA	
		$V_{ON} = 0\text{V}$, $V_{OUT} = 0\text{V}$ @ $V_{IN} = 3.3\text{V}$, $T_A = 25^\circ\text{C}$		10	100	nA	
FLAGB Output Logic Low Voltage		$V_{IN} = 5\text{V}$, $I_{SINK} = 10\text{mA}$	-	-	0.2	V	
		$V_{IN} = 1.8\text{V}$, $I_{SINK} = 10\text{mA}$	-	-	0.3		
FLAGB Output High Leakage Current		$V_{IN} = 5\text{V}$, Switch on	-	-	1	μA	

Electrical Characteristics Cont.

$V_{IN} = 1.8$ to $5.5V$, $T_A = -40$ to $+85^\circ C$ unless otherwise noted. Typical values are at $V_{IN} = 3.3V$ and $T_A = 25^\circ C$.

Parameter	Symbol	Conditions	Min	Typ	Max	Units
Protections						
Current Limit	I_{LIM}	$V_{IN} = 3.3V$	200	300	400	mA
Thermal Shutdown		Shutdown Threshold	-	140	-	°C
		Return from Shutdown	-	130	-	
		Hysteresis	-	10	-	
Under Voltage Shutdown	UVLO	V_{IN} Increasing	1.5	1.6	1.7	V
Under Voltage Shutdown Hysteresis			-	47	-	mV
Zener Clamp Voltage	V_Z	$I_Z = 1mA$	-	15.58	-	V
Zener Leakage	I_Z	$V_Z = 12V$	-	-	10	μA
Dynamic						
Delay On Time	t_{dON}	$R_L = 500\Omega$, $C_L = 0.1\mu F$	-	25	50	μs
Delay Off Time	t_{dOFF}	$R_L = 500\Omega$, $C_L = 0.1\mu F$	-	20	40	μs
V_{OUT} Rise Time	t_R	$R_L = 500\Omega$, $C_L = 0.1\mu F$	-	14	30	μs
V_{OUT} Fall Time	t_F	$R_L = 500\Omega$, $C_L = 0.1\mu F$	-	126	250	μs
Over Current Blanking Time	t_{BLANK}		5	10	20	ms
Short Circuit Response Time		$V_{IN} = V_{ON} = 3.3V$. Moderate Over-Current Condition.	-	3	-	μs
		$V_{IN} = V_{ON} = 3.3V$. Hard Short.	-	20	-	ns

Note 1: Package power dissipation on 1 square inch pad, 2 oz. copper board.

Typical Characteristics

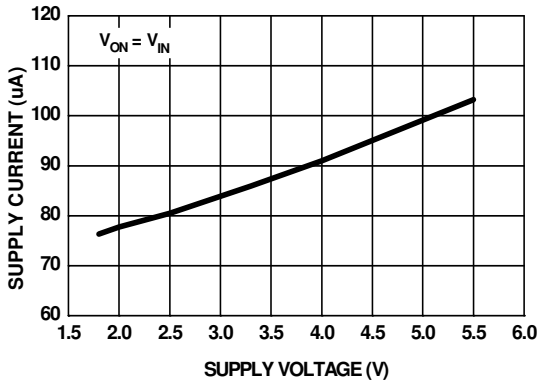

Figure 1. Quiescent Current vs. Input Voltage

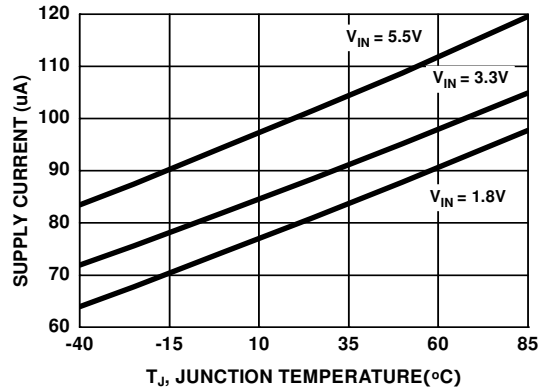

Figure 2. Quiescent Current vs. Temperature

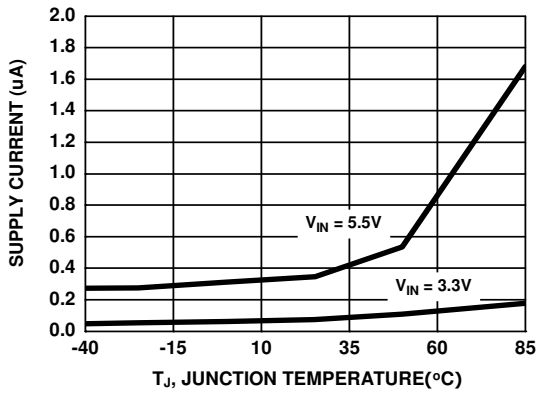

Figure 3. I_{SHUTDOWN} Current vs. Temperature

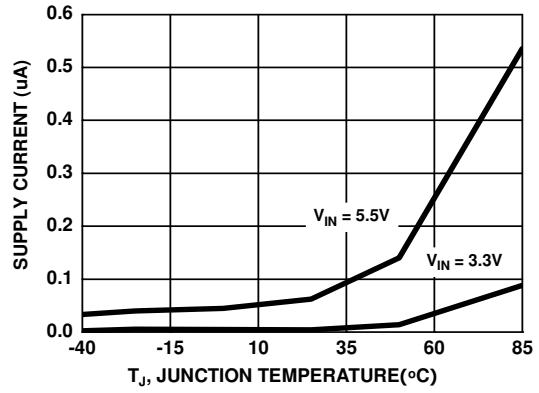

Figure 4. I_{SWITCH-OFF} Current vs. Temperature

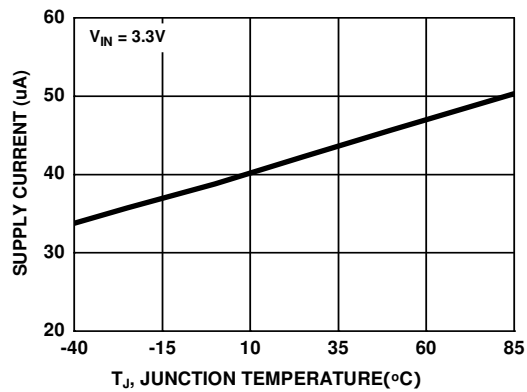

Figure 5. Latchoff current vs. Temperature

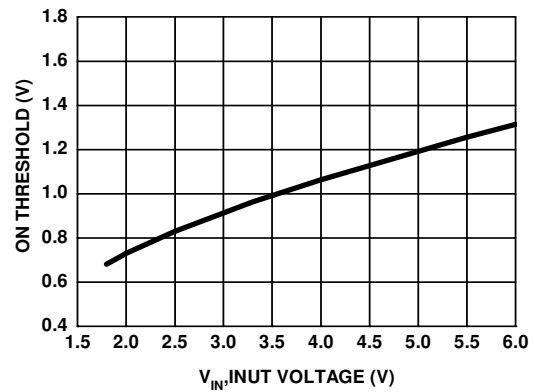

Figure 6. Input Voltage vs. On Threshold Voltage

Typical Characteristics

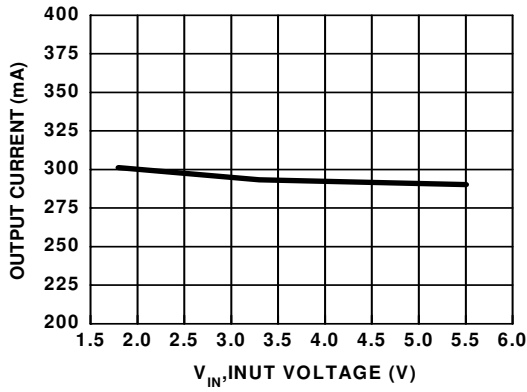

Figure 7. Current Limit vs. Output Voltage

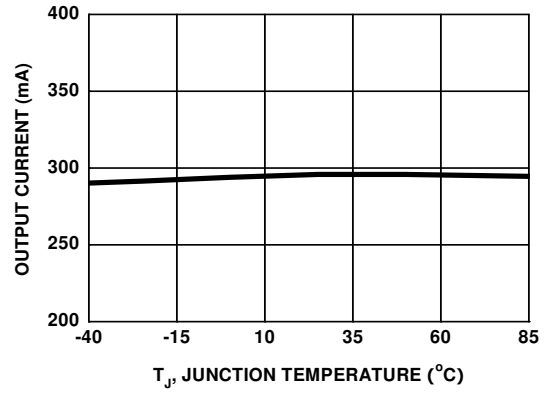

Figure 8. Current Limit vs. Temperature

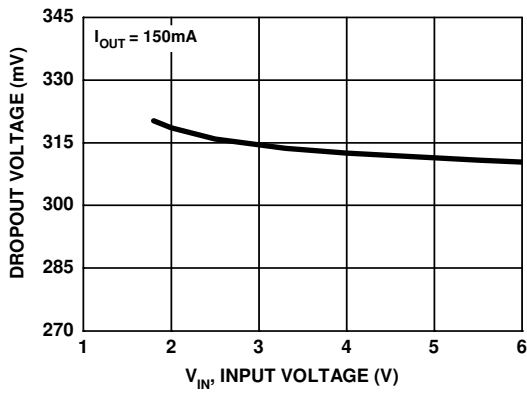

Figure 9. Drop Voltage vs. Input Voltage

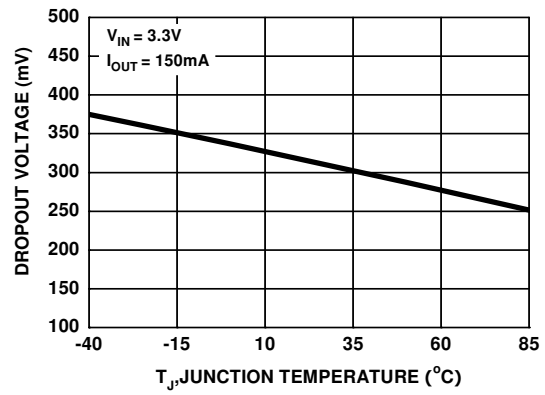

Figure 10. Drop Voltage vs. Temperature

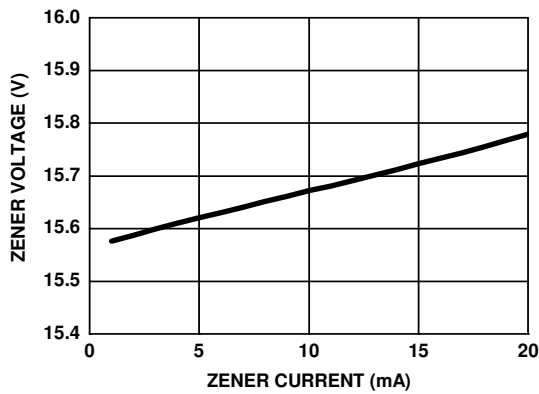

Figure 11. Zener Voltage vs. Zener Current

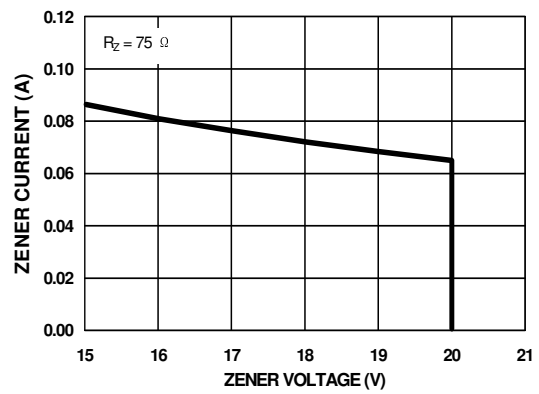

Figure 12. Zener Diode Safe Operating Area

Typical Characteristics

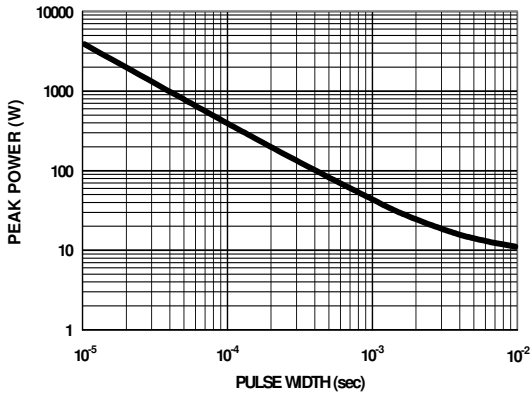

Figure 13. Single Pulse Maximum Power Dissipation of Zener Diode

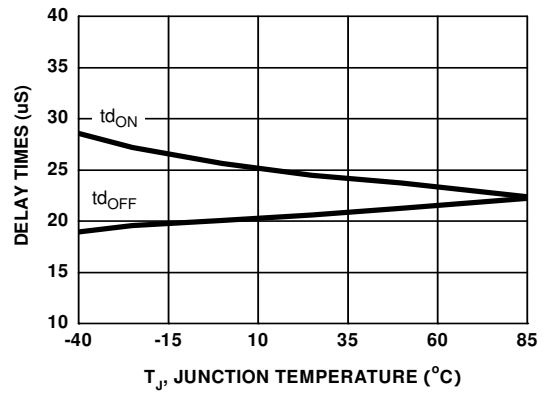

Figure 14. T_{ON}/T_{OFF} vs. Temperature

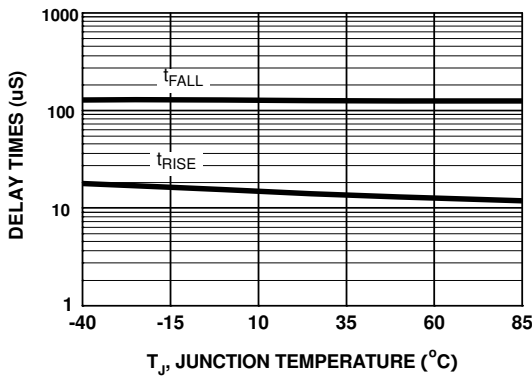

Figure 15. T_{Rise}/T_{Fall} vs. Temperature

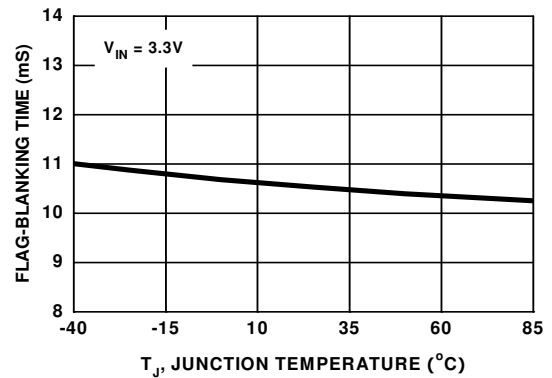

Figure 16. T_{BLANK} vs. Temperature

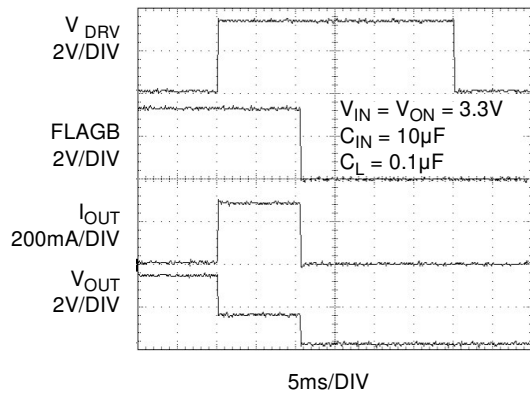

Figure 17. T_{BLANK} Response

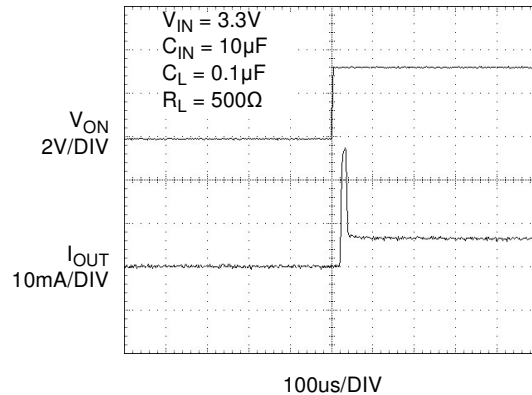

Figure 18. T_{ON} Response

Typical Characteristics

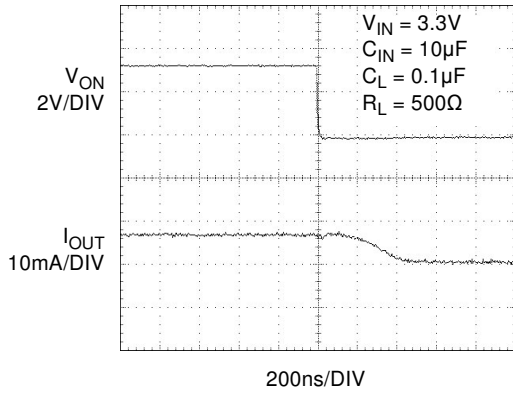

Figure 19. T_{OFF} Response

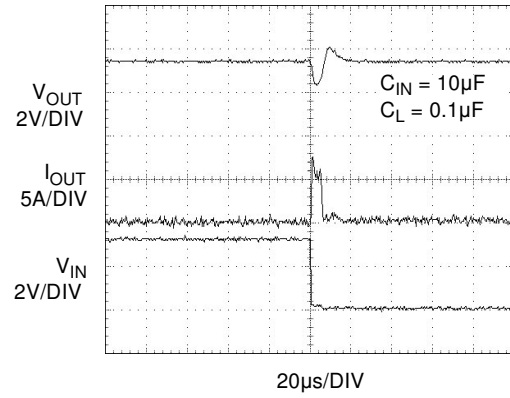

Figure 20. Short Circuit Response Time
(Output Shorted to GND)

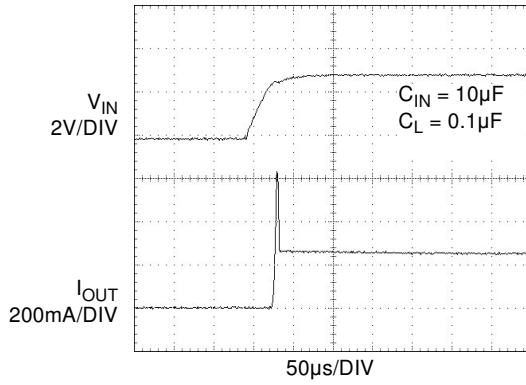

Figure 21. Current Limit Response Time
(Switch power up to hard short)

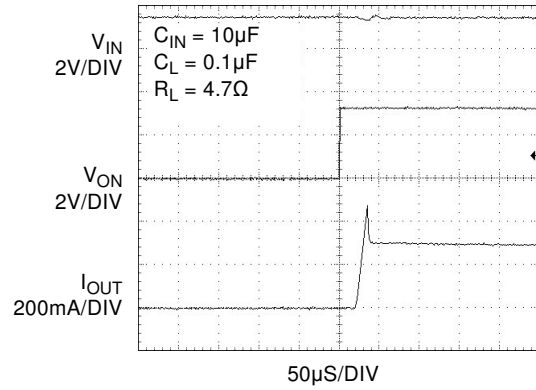

Figure 22. Current Limit Response Time
(Output has a 4.7Ω load)

Description of Operation

The FPF2174 is a current limited switch that protects systems and loads which can be damaged or disrupted by the application of high currents. The core of the device is a 0.125Ω P-channel MOSFET and a controller capable of functioning over a wide input operating range of 1.8-5.5V paired with a low forward voltage drop Schottky diode for reverse blocking and a 16V zener diode for output clamp. The controller protects against system malfunctions through current limiting, under-voltage lockout and thermal shutdown. The current limit is preset for 200mA.

On/Off Control

The ON pin controls the state of the switch. Activating ON continuously holds the switch in the on state so long as there is no under-voltage on V_{IN} or a junction temperature in excess of 150°C. ON is active HI and has a low threshold making it capable of interfacing with low voltage signals. When the MOSFET is off, the Schottky diode acts as a barrier so that no reverse current can flow when V_{OUT} is greater than V_{IN} .

Fault Reporting

Upon the detection of an over-current, an input under-voltage, or an over-temperature condition, the FLAGB signals the fault mode by activating LO. The FLAGB goes LO at the end of the blanking time and is latched LO and ON must be toggled to release it. FLAGB is an open-drain MOSFET which requires a pull-up resistor between V_{IN} and FLAGB. During shutdown, the pull-down on FLAGB is disabled to reduce current draw from the supply.

Current Limiting

The current limit guarantees that the current through the switch doesn't exceed a maximum value while not limiting at less than a minimum value. The minimum current is 200mA and the maximum current is 400mA. The device has a blanking time of 10ms, nominally, during which the switch will act as a constant current source. At the end of the blanking time, the switch will be turned-off and the FLAGB pin will activate to indicate that current limiting has occurred.

Under-Voltage Lockout

The under-voltage lockout turns-off the switch if the input voltage drops below the under-voltage lockout threshold. With the ON pin active the input voltage rising above the under-voltage lockout threshold will cause a controlled turn-on of the switch which limits current over-shoots.

Thermal Shutdown

The thermal shutdown protects the die from internally or externally generated excessive temperatures. During an over-temperature condition the FLAGB is activated and the switch is turned-off. The switch automatically turns-on again if temperature of the die drops below the threshold temperature.

Transient Safe Operating Area of Zener Diode

Integrated zener diode is designed to protect systems from a transient over voltage stress resulting from a flyback voltage ($L \cdot di/dt$) such as connecting the output of switch to an active rails.

When the transient voltage exceed the zener threshold (V_z) the zener starts conducting and prevents the output of loadswitch from experiencing those transient over voltages and protects any reverse current from flowing through the switch. For reliable operation, user should not exceed the SOA curve shown in Figure 13.

Application Information

Typical Application

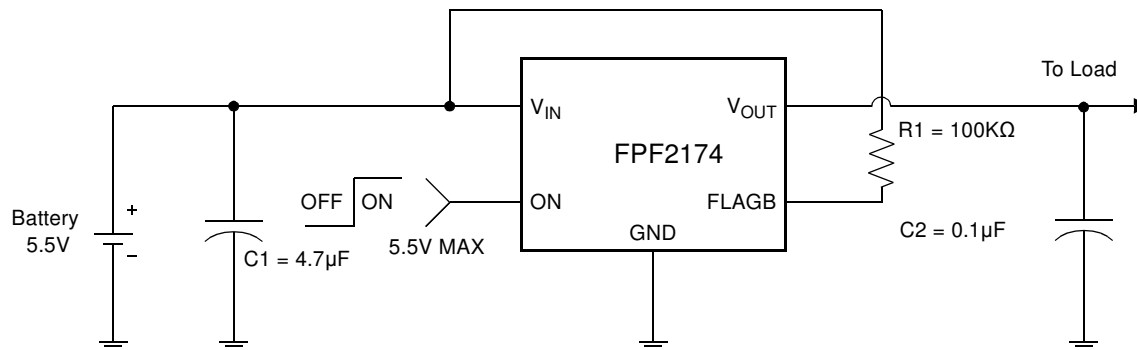

Input Capacitor

To limit the voltage drop on the input supply caused by transient in-rush currents when the switch turns-on into a discharged load capacitor or a short-circuit, a capacitor needs to be placed between V_{IN} and GND. A 4.7µF ceramic capacitor, C_{IN} , placed close to the pins is usually sufficient. Higher values of C_{IN} can be used to further reduce the voltage drop.

Output Capacitor

A 0.1µF capacitor C_{OUT} , should be placed between V_{OUT} and GND. This capacitor will prevent parasitic board inductances from forcing V_{OUT} below GND when the switch turns-off.

Power Dissipation

During normal operation as a switch, the power dissipation is small and has little effect on the operating temperature of the part. The parts with the higher current limits will dissipate the most power and that will only be typically,

$$P = I_{LIM} \times V_{DROP} = 0.4 \times 0.4 = 160\text{mW} \quad (2)$$

When using the part, attention must be given to the manual resetting of the part. Continuously resetting the part at a high duty cycle when a short on the output is present can cause the temperature of the part to increase. The junction temperature will only be allowed to increase to the thermal shutdown threshold. Once this temperature has been reached, toggling ON will not turn-on the switch until the junction temperature drops.

Board Layout

For best performance, all traces should be as short as possible. To be most effective, the input and output capacitors should be placed close to the device to minimize the effects that parasitic trace inductances may have on normal and short-circuit operation. Using wide traces for V_{IN} , V_{OUT} and GND will help minimize parasitic electrical effects along with minimizing the case to ambient thermal impedance.

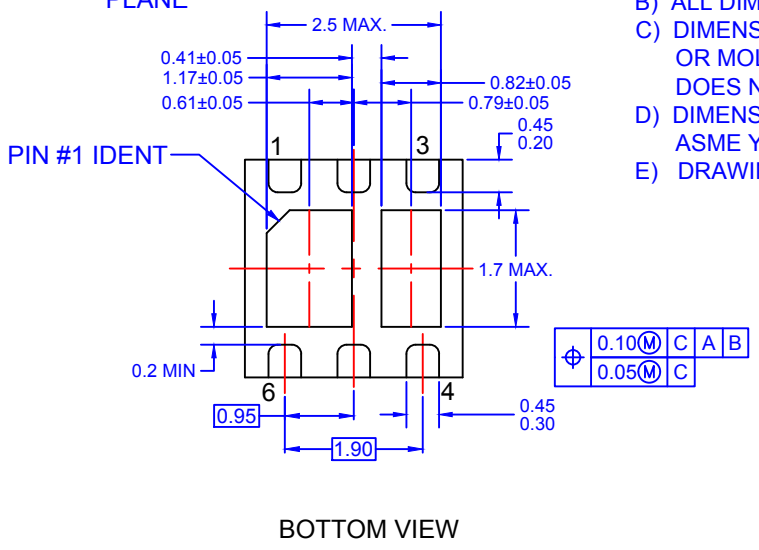
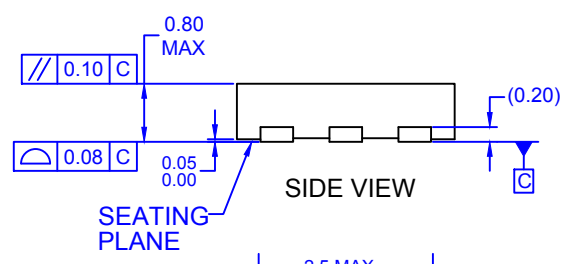
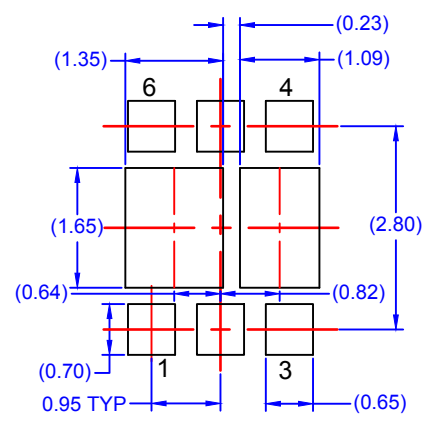
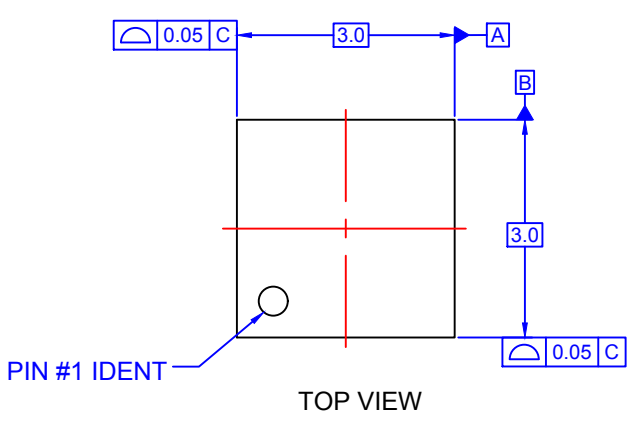

- NOTES: UNLESS OTHERWISE SPECIFIED
- A) CONFORMS TO JEDEC REGISTRATION, MO-229, VARIATION WEEA
 - B) ALL DIMENSIONS ARE IN MILLIMETERS.
 - C) DIMENSIONS DO NOT INCLUDE BURRS OR MOLD FLASH. MOLD FLASH OR BURRS DOES NOT EXCEED 0.10MM.
 - D) DIMENSIONING AND TOLERANCING PER ASME Y14.5M-2009.
 - E) DRAWING FILE NAME: MKT-MLP06HREV2



ON Semiconductor and  are trademarks of Semiconductor Components Industries, LLC dba ON Semiconductor or its subsidiaries in the United States and/or other countries. ON Semiconductor owns the rights to a number of patents, trademarks, copyrights, trade secrets, and other intellectual property. A listing of ON Semiconductor's product/patent coverage may be accessed at www.onsemi.com/site/pdf/Patent-Marking.pdf. ON Semiconductor reserves the right to make changes without further notice to any products herein. ON Semiconductor makes no warranty, representation or guarantee regarding the suitability of its products for any particular purpose, nor does ON Semiconductor assume any liability arising out of the application or use of any product or circuit, and specifically disclaims any and all liability, including without limitation special, consequential or incidental damages. Buyer is responsible for its products and applications using ON Semiconductor products, including compliance with all laws, regulations and safety requirements or standards, regardless of any support or applications information provided by ON Semiconductor. "Typical" parameters which may be provided in ON Semiconductor data sheets and/or specifications can and do vary in different applications and actual performance may vary over time. All operating parameters, including "Typicals" must be validated for each customer application by customer's technical experts. ON Semiconductor does not convey any license under its patent rights nor the rights of others. ON Semiconductor products are not designed, intended, or authorized for use as a critical component in life support systems or any FDA Class 3 medical devices or medical devices with a same or similar classification in a foreign jurisdiction or any devices intended for implantation in the human body. Should Buyer purchase or use ON Semiconductor products for any such unintended or unauthorized application, Buyer shall indemnify and hold ON Semiconductor and its officers, employees, subsidiaries, affiliates, and distributors harmless against all claims, costs, damages, and expenses, and reasonable attorney fees arising out of, directly or indirectly, any claim of personal injury or death associated with such unintended or unauthorized use, even if such claim alleges that ON Semiconductor was negligent regarding the design or manufacture of the part. ON Semiconductor is an Equal Opportunity/Affirmative Action Employer. This literature is subject to all applicable copyright laws and is not for resale in any manner.

PUBLICATION ORDERING INFORMATION

LITERATURE FULFILLMENT:

Literature Distribution Center for ON Semiconductor
19521 E. 32nd Pkwy, Aurora, Colorado 80011 USA
Phone: 303-675-2175 or 800-344-3860 Toll Free USA/Canada
Fax: 303-675-2176 or 800-344-3867 Toll Free USA/Canada
Email: orderlit@onsemi.com

N. American Technical Support: 800-282-9855 Toll Free
USA/Canada
Europe, Middle East and Africa Technical Support:
Phone: 421 33 790 2910
Japan Customer Focus Center
Phone: 81-3-5817-1050

ON Semiconductor Website: www.onsemi.com
Order Literature: <http://www.onsemi.com/orderlit>
For additional information, please contact your local
Sales Representative