



## 18-BIT, 600-kHz, FULLY DIFFERENTIAL PSEUDO-BIPOLAR INPUT, MICROPOWER SAMPLING ANALOG-TO-DIGITAL CONVERTER WITH SERIAL INTERFACE AND REFERENCE

### FEATURES

- 600-kHz Sample Rate
- $\pm 1.25$  LSB Typ,  $\pm 3$  LSB Max INL
- 18-Bit NMC Ensured Over Temperature
- SINAD 96 dB, SFDR 120 dB at  $f_i = 1$  kHz
- High-Speed Serial Interface up to 40 MHz
- Onboard Reference Buffer
- Onboard 4.096-V Reference
- Pseudo-Bipolar Input, up to  $\pm 4.2$  V
- Onboard Conversion Clock
- Zero Latency
- Wide Digital Supply
- Low Power
  - 115 mW at 600 kHz
  - 15 mW During Nap Mode
  - 10  $\mu$ W During Power Down
- 28-Pin 6  $\times$  6 QFN Package

### APPLICATIONS

- Medical Instruments
- Optical Networking
- Transducer Interface
- High Accuracy Data Acquisition Systems
- Magnetometers

### DESCRIPTION

The ADS8382 is a high performance 18-bit, 600-kHz A/D converter with fully differential, pseudo-bipolar input. The device includes an 18-bit capacitor-based SAR A/D converter with inherent sample and hold. The ADS8382 offers a high-speed CMOS serial interface with clock speeds up to 40 MHz.

The ADS8382 is available in a 28 lead 6  $\times$  6 QFN package and is characterized over the industrial  $-40^\circ\text{C}$  to  $85^\circ\text{C}$  temperature range.

### High Speed SAR Converter Family

Type/Speed	500 kHz	~ 600 kHz	750 kHz	1 MHz	1.25 MHz	2 MHz	3 MHz	4 MHz
18-Bit Pseudo-Diff	ADS8383	ADS8381						
		ADS8380 (S)						
18-Bit Pseudo-Bipolar, Fully Diff		ADS8382 (S)						
16-Bit Pseudo-Diff			ADS8371		ADS8401/05	ADS8411		
16-Bit Pseudo-Bipolar, Fully Diff					ADS8402/06	ADS8412		
14-Bit Pseudo-Diff					ADS7890 (S)		ADS7891	
12-Bit Pseudo-Diff				ADS7886				ADS7881

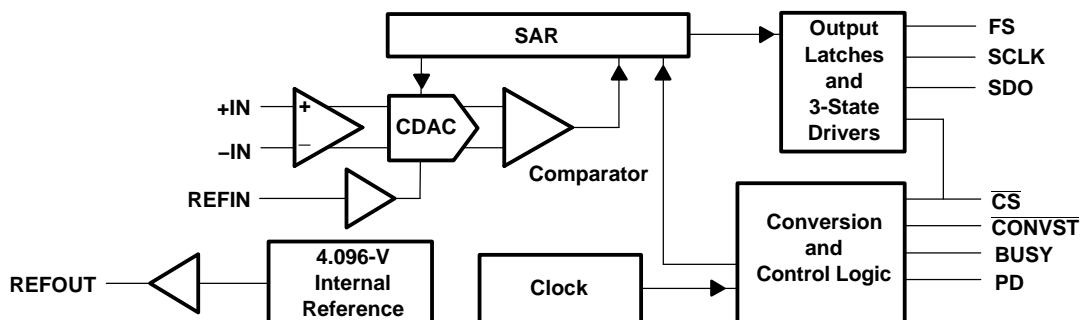

Please be aware that an important notice concerning availability, standard warranty, and use in critical applications of Texas Instruments semiconductor products and disclaimers thereto appears at the end of this data sheet.



These devices have limited built-in ESD protection. The leads should be shorted together or the device placed in conductive foam during storage or handling to prevent electrostatic damage to the MOS gates.

**ORDERING INFORMATION<sup>(1)</sup>**

MODEL	MAXIMUM INTEGRAL LINEARITY (LSB)	MAXIMUM DIFFERENTIAL LINEARITY (LSB)	NO MISSING CODES RESOLUTION (BIT)	PACKAGE TYPE	PACKAGE DESIGNATOR	TEMPERATURE RANGE	ORDERING INFORMATION	TRANSPORT MEDIA QUANTITY
ADS8382I	±5	-2/2.5	17	28 Pin 6×6 QFN	RHP	-40°C to 85°C	ADS8382IRHPT	Small Tape and Reel 250
							ADS8382IRHPR	Tape and Reel 2500
ADS8382IB	±3	-1/1.5	18	28 Pin 6×6 QFN	RHP	-40°C to 85°C	ADS8382IBRHPT	Small Tape and Reel 250
							ADS8382IBRHPR	Tape and Reel 2500

(1) For the most current specifications and package information, refer to our web site at [www.ti.com](http://www.ti.com)

**ABSOLUTE MAXIMUM RATINGS**

over operating free-air temperature range (unless otherwise noted)<sup>(1)</sup>

		UNIT
Voltage	+IN to AGND	-0.3 V to +VA + 0.3 V
	-IN to AGND	-0.3 V to +VA + 0.3 V
	+VA to AGND	-0.3 V to 7 V
	+VBD to BDGND	-0.3 V to 7 V
Digital input voltage to BDGND		-0.3 V to +VBD + 0.3 V
Digital input voltage to +VA		+0.3 V
Operating free-air temperature range, T <sub>A</sub>		-40°C to 85°C
Storage temperature range, T <sub>stg</sub>		-65°C to 150°C
Junction temperature (T <sub>J</sub> max)		150°C
QFN package	Power dissipation	(T <sub>J</sub> max - T <sub>A</sub> )/θ <sub>JA</sub>
	θ <sub>JA</sub> thermal impedance	86°C/W
Lead temperature, soldering	Vapor phase (60 sec)	215°C
	Infrared (15 sec)	220°C

(1) Stresses beyond those listed under "absolute maximum ratings" may cause permanent damage to the device. These are stress ratings only, and functional operation of the device at these or any other conditions beyond those indicated under "recommended operating conditions" is not implied. Exposure to absolute-maximum-rated conditions for extended periods may affect device reliability.

## SPECIFICATIONS

At  $-40^{\circ}\text{C}$  to  $85^{\circ}\text{C}$ ,  $+VA = +5\text{ V}$ ,  $+VBD = +5\text{ V}$  or  $+VBD = +2.7\text{ V}$ , using internal or external reference,  $f_{\text{SAMPLE}} = 600\text{ kHz}$ , unless otherwise noted. (All performance parameters are valid only after device has properly resumed from power down, [Table 2.](#))

PARAMETER	TEST CONDITIONS	ADS8382IB			ADS8382I			UNIT
		MIN	TYP	MAX	MIN	TYP	MAX	
<b>ANALOG INPUT</b>								
	Full-scale input voltage <sup>(1)</sup>	+IN – (–IN)	$-V_{\text{ref}}$	$V_{\text{ref}}$	$-V_{\text{ref}}$	$V_{\text{ref}}$		V
	Absolute input voltage	+IN	$-0.2$	$V_{\text{ref}} + 0.2$	$-0.2$	$V_{\text{ref}} + 0.2$		V
		–IN	$-0.2$	$V_{\text{ref}} + 0.2$	$-0.2$	$V_{\text{ref}} + 0.2$		V
	Input common mode range		$(V_{\text{ref}}/2) - 0.2$	$(V_{\text{ref}}/2) + 0.2$	$(V_{\text{ref}}/2) - 0.2$	$(V_{\text{ref}}/2) + 0.2$		V
	Sampling capacitance (measured between +IN to AGND and –IN to AGND)			40		40		pF
	Input leakage current			1		1		nA
<b>SYSTEM PERFORMANCE</b>								
	Resolution			18		18		Bits
	No missing codes			18		17		Bits
INL	Integral linearity <sup>(2)(3)(4)</sup>	Quiet zones observed	$-3$	$\pm 1.25$	$3$	$-5$	$5$	LSB (18 bit)
		Quiet zones not observed		$\pm 2$				
DNL	Differential linearity <sup>(3)</sup>	Quiet zones observed	$-1$	$\pm 0.6$	$1.5$	$-2$	$2.5$	LSB (18 bit)
		Quiet zones not observed		$\pm 1.25$				
$E_{\text{O}}$	Offset error <sup>(3)</sup>		$-0.75$	$\pm 0.25$	$0.75$	$-1.5$	$1.5$	mV
$E_{\text{G}}$	Gain error <sup>(3)(5)</sup>		$-0.075$		$0.075$	$-0.1$	$0.1$	%FS
CMRR	Common-mode rejection ratio	At DC		80		80		dB
		$[(+IN + (-IN))/2 = 50\text{ mV}_{\text{p-p}}$ at 1 MHz + DC of $V_{\text{ref}}/2$		55		55		
	Noise	At 00000H output code		40		40		$\mu\text{V RMS}$
PSRR	DC Power supply rejection ratio	At 10000H output code		55		55		dB
<b>SAMPLING DYNAMICS</b>								
	Conversion time			1.16		1.16		$\mu\text{s}$
	Acquisition time		0.50	1000	0.50	1000		$\mu\text{s}$
	Throughput rate			600		600		kHz
	Aperture delay			10		10		ns
	Aperture jitter			12		12		ps RMS
	Step response	<sup>(6)</sup>		400		400		ns
	Overvoltage recovery			400		400		ns
<b>DYNAMIC CHARACTERISTICS</b>								
THD	Total harmonic distortion <sup>(3)(7)</sup>	$V_{\text{IN}} = 8\text{ V}_{\text{p-p}}$ at 1 kHz		-116		-116		dB
		$V_{\text{IN}} = 8\text{ V}_{\text{p-p}}$ at 10 kHz		-115		-115		
		$V_{\text{IN}} = 8\text{ V}_{\text{p-p}}$ at 100 kHz		-96		-96		
SNR	Signal-to-noise ratio <sup>(3)</sup>	$V_{\text{IN}} = 8\text{ V}_{\text{p-p}}$ at 1 kHz		96		96		dB
		$V_{\text{IN}} = 8\text{ V}_{\text{p-p}}$ at 10 kHz		95		95		
		$V_{\text{IN}} = 8\text{ V}_{\text{p-p}}$ at 100 kHz		94		94		

(1) Ideal input span; does not include gain or offset error.

(2) LSB means least significant bit.

(3) Measured using analog input circuit in [Figure 54](#) and digital stimulus in [Figure 58](#) and [Figure 59](#) and reference voltage of 4.096 V.

(4) This is endpoint INL, not best fit.

(5) Measured using external reference source so does not include internal reference voltage error or drift.

(6) Defined as sampling time necessary to settle an initial error of  $2V_{\text{ref}}$  on the sampling capacitor to a final error of 1 LSB at 18-bit level. Measured using the input circuit in [Figure 54](#).

(7) Calculated on the first nine harmonics of the input frequency.

**SPECIFICATIONS (continued)**

At –40°C to 85°C, +VA = +5 V, +VBD = +5 V or +VBD = +2.7 V, using internal or external reference,  $f_{SAMPLE} = 600$  kHz, unless otherwise noted. (All performance parameters are valid only after device has properly resumed from power down, Table 2.)

PARAMETER		TEST CONDITIONS	ADS8382IB			ADS8382I			UNIT
			MIN	TYP	MAX	MIN	TYP	MAX	
SINAD	Signal-to-noise + distortion <sup>(3) (7)</sup>	VIN = 8 V <sub>p-p</sub> at 1 kHz	96			96			dB
		VIN = 8 V <sub>p-p</sub> at 10 kHz	95			95			
		VIN = 8 V <sub>p-p</sub> at 100 kHz	92			92			
SFDR	Spurious free dynamic range <sup>(3)</sup>	VIN = 8 V <sub>p-p</sub> at 1 kHz	120			120			dB
		VIN = 8 V <sub>p-p</sub> at 10 kHz	120			120			
		VIN = 8 V <sub>p-p</sub> at 100 kHz	99			99			
	–3dB Small signal bandwidth		75			75			MHz
<b>REFERENCE INPUT</b>									
V <sub>ref</sub>	Reference voltage input range		2.5	4.096	4.2	2.5	4.096	4.2	V
	Resistance <sup>(8)</sup>		10			10			MΩ
<b>INTERNAL REFERENCE OUTPUT</b>									
V <sub>ref</sub>	Reference voltage range	IOUT = 0 A, T <sub>A</sub> = 30°C	4.088	4.096	4.104	4.088	4.096	4.104	V
	Source current	Static load	10			10			μA
	Line regulation	+VA = 4.75 V to 5.25 V	2.5			2.5			mV
	Drift	IOUT = 0 A	25			25			ppm/°C
<b>DIGITAL INPUT/OUTPUT</b>									
	Logic family CMOS								
V <sub>IH</sub>	High level input voltage		+VBD – 1		+VBD + 0.3	+VBD – 1		+VBD + 0.3	V
V <sub>IL</sub>	Low level input voltage		–0.3		0.8	–0.3		0.8	V
V <sub>OH</sub>	High level output voltage	I <sub>OH</sub> = 2 TTL loads	+VBD –0.6			+VBD –0.6			V
V <sub>OL</sub>	Low level output voltage	I <sub>OL</sub> = 2 TTL loads			0.4			0.4	V
	Data format 2's complement (MSB first)								
<b>POWER SUPPLY REQUIREMENTS</b>									
	Power supply voltage	+VA	4.75	5	5.25	4.75	5	5.25	V
		+VBD	2.7	3.3	5.25	2.7	3.3	5.25	V
I <sub>CC</sub>	Supply current, 600-kHz sample rate <sup>(9)</sup>	+VA = 5 V	22		25	22		25	mA
<b>POWER DOWN</b>									
I <sub>CC(PD)</sub>	Supply current, power down		2			2			μA
<b>NAP MODE</b>									
I <sub>CC(NAP)</sub>	Supply current, nap mode		3			3			mA
	Power-up time from nap		300			300			ns
<b>TEMPERATURE RANGE</b>									
	Specified performance		–40		85	–40		85	°C

(8) Can vary +/-30%.

(9) This includes only +VA current. With +VBD = 5 V, +VBD current is typically 1 mA with a 10-pF load capacitance on the digital output pins.

**TIMING REQUIREMENTS**<sup>(1)(2)(3)(4)(5)(6)</sup>

PARAMETER		ADS8382I/ADS8382IB			UNIT	REF FIGURE
		MIN	TYP	MAX		
t <sub>conv</sub>	Conversion time	1000		1160	ns	43,44, 45,46
t <sub>acq1</sub>	Acquisition time in normal mode	0.5		1000	μs	43,44,46
t <sub>acq2</sub>	Acquisition time in nap mode (t <sub>acq2</sub> = t <sub>acq1</sub> + t <sub>d18</sub> )	0.8		1000	μs	45
<b>CONVERSION AND SAMPLING</b>						
t <sub>quiet1</sub>	Quiet sampling time (last toggle of interface signals to convert start command) <sup>(6)</sup>	30			ns	42,43,44, 45,47,48, 49
t <sub>quiet2</sub>	Quiet sampling time (convert start command to first toggle of interface signals) <sup>(6)</sup>	10			ns	42,43,44, 45,47,48, 49
t <sub>quiet3</sub>	Quiet conversion time (last toggle of interface signals to fall of BUSY) <sup>(6)</sup>	600			ns	42,43,44, 45,47,49
t <sub>su1</sub>	Setup time, $\overline{\text{CONVST}}$ before BUSY fall	15			ns	43
t <sub>su2</sub>	Setup time, $\overline{\text{CS}}$ before BUSY fall (only for conversion/sampling control)	20			ns	42,43
t <sub>su4</sub>	Setup time, $\overline{\text{CONVST}}$ before $\overline{\text{CS}}$ rise (so $\overline{\text{CONVST}}$ can be recognized)	5			ns	43,44,46
t <sub>h1</sub>	Hold time, $\overline{\text{CS}}$ after BUSY fall (only for conversion/sampling control)	0			ns	43
t <sub>h3</sub>	Hold time, $\overline{\text{CONVST}}$ after $\overline{\text{CS}}$ rise	7			ns	45
t <sub>h4</sub>	Hold time, $\overline{\text{CONVST}}$ after $\overline{\text{CS}}$ fall (to ensure width of $\overline{\text{CONVST\_QUAL}}$ ) <sup>(4)</sup>	20			ns	44
t <sub>w1</sub>	$\overline{\text{CONVST}}$ pulse duration	20			ns	45
t <sub>w2</sub>	$\overline{\text{CS}}$ pulse duration	10			ns	43,44
t <sub>w5</sub>	Pulse duration, time between conversion start command and conversion abort command to successfully abort the ongoing conversion			1000	ns	46
<b>DATA READ OPERATION</b>						
t <sub>cyc</sub>	SCLK period	25			ns	47,48,49
	SCLK duty cycle	40%		60%		
t <sub>su5</sub>	Setup time, $\overline{\text{CS}}$ fall before first SCLK fall	10			ns	47
t <sub>su6</sub>	Setup time, $\overline{\text{CS}}$ fall before FS rise	7			ns	48,49
t <sub>su7</sub>	Setup time, FS fall before first SCLK fall	7			ns	48,49
t <sub>h5</sub>	Hold time, $\overline{\text{CS}}$ fall after SCLK fall	3			ns	47
t <sub>h6</sub>	Hold time, FS fall after SCLK fall	7			ns	48,49
t <sub>su2</sub>	Setup time, $\overline{\text{CS}}$ fall before BUSY fall (only for read control)	20			ns	42,47
t <sub>su3</sub>	Setup time, FS fall before BUSY fall (only for read control)	20			ns	42,49
t <sub>h2</sub>	Hold time, $\overline{\text{CS}}$ fall after BUSY fall (only for read control)	15			ns	42,47
t <sub>h8</sub>	Hold time, FS fall after BUSY fall (only for read control)	15			ns	42,49
t <sub>w2</sub>	$\overline{\text{CS}}$ pulse duration	10			ns	47
t <sub>w3</sub>	FS pulse duration	10			ns	48,49
<b>MISCELLANEOUS</b>						
t <sub>w4</sub>	PD pulse duration for reset and power down	60			ns	55,56
	All unspecified pulse durations	10			ns	

- (1) All input signals are specified with t<sub>r</sub> = t<sub>f</sub> = 5 ns (10% to 90% of V<sub>DD</sub>) and timed from a voltage level of (V<sub>IL</sub> + V<sub>IH</sub>)/2.
- (2) All specifications typical at –40°C to 85°C, +VA = +4.75 V to +5.25 V, +VBD = +2.7 V to +5.25 V.
- (3) All digital output signals loaded with 10-pF capacitors.
- (4)  $\overline{\text{CONVST\_QUAL}}$  is  $\overline{\text{CONVST}}$  latched by a low value on  $\overline{\text{CS}}$  (see Figure 41).
- (5) Reference figure indicated is only a representative of where the timing is applicable and is not exhaustive.
- (6) Quiet time zones are for meeting performance and not functionality.

**TIMING CHARACTERISTICS**<sup>(1)(2)(3)(4)</sup>

PARAMETER		ADS8382I/ADS8382IB			UNIT	REF FIGURE
		MIN	TYP	MAX		
<b>CONVERSION AND SAMPLING</b>						
t <sub>d1</sub>	Delay time, conversion start command to conversion start (aperture delay)			10	ns	43,45
t <sub>d2</sub>	Delay time, conversion end to BUSY fall			5	ns	43,44,45
t <sub>d4</sub>	Delay time, conversion start command to BUSY rise			20	ns	43
t <sub>d3</sub>	Delay time, $\overline{\text{CONVST}}$ rise to sample start			5	ns	45
t <sub>d5</sub>	Delay time, $\overline{\text{CS}}$ fall to sample start			10	ns	45
t <sub>d6</sub>	Delay time, conversion abort command to BUSY fall			10	ns	46
<b>DATA READ OPERATION</b>						
t <sub>d12</sub>	Delay time, $\overline{\text{CS}}$ fall to MSB valid	3		15	ns	47
t <sub>d15</sub>	Delay time, FS rise to MSB valid	6		18	ns	48,49
t <sub>d7</sub>	Delay time, BUSY fall to MSB valid (if FS is high when BUSY falls)			18	ns	49
t <sub>d13</sub>	Delay time, SCLK rise to bit valid	2		10	ns	47,48,49
t <sub>d14</sub>	Delay time, $\overline{\text{CS}}$ rise to SDO 3-state			6	ns	47
<b>MISCELLANEOUS</b>						
t <sub>d10</sub>	Delay time, PD rise to SDO 3-state			55	ns	55,56
t <sub>d18</sub>	Delay time, total device resume time	Nap mode		300	ns	57
		Full power down (external reference used with or without 1- $\mu$ F  0.1- $\mu$ F capacitor on REFOUT)		t <sub>d11</sub> + 2x conversions		56
		Full power down (internal reference used with or without 1- $\mu$ F  0.1- $\mu$ F capacitor on REFOUT)		25 <sup>(4)</sup>	ms	55
t <sub>d11</sub>	Delay time, untrimmed circuit full power-down resume time			1	ms	55,56
t <sub>d16</sub>	Delay time, device power-down time	Nap		200	ns	57
		Full power down (internal/external reference used)		10	$\mu$ s	55,56
t <sub>d17</sub>	Delay time, trimmed internal reference settling (either by turning on supply or resuming from full power-down mode), with 1- $\mu$ F  0.1- $\mu$ F capacitor on REFOUT			4	ms	55

- (1) All input signals are specified with t<sub>r</sub> = t<sub>f</sub> = 5 ns (10% to 90% of V<sub>DD</sub>) and timed from a voltage level of (V<sub>IL</sub> + V<sub>IH</sub>)/2.
- (2) All specifications typical at –40°C to 85°C, +VA = +4.75 V to +5.25 V, +VBD = +2.7 V to +5.25 V.
- (3) All digital output signals loaded with 10-pF capacitors.
- (4) Including t<sub>d11</sub>, two conversions (time to cycle CONVST twice), and t<sub>d17</sub>.

**PIN ASSIGNMENTS**

**TOP VIEW**

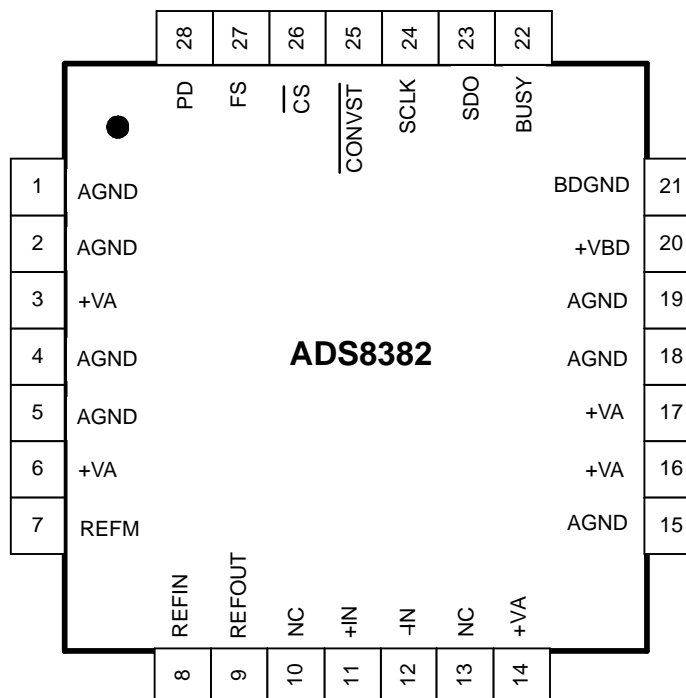

**TERMINAL FUNCTIONS**

PIN		I/O	DESCRIPTION
NAME	NO.		
AGND	1, 2, 4, 5, 15, 18, 19	–	Analog ground pins. AGND must be shorted to analog ground plane below the device.
BDGND	21	–	Digital ground for all digital inputs and outputs. BDGND must be shorted to the analog ground plane below the device.
BUSY	22	O	Status output. This pin is high when conversion is in progress.
$\overline{CONVST}$	25	I	Convert start. This signal is qualified with $\overline{CS}$ internally.
$\overline{CS}$	26	I	Chip select
FS	27	I	Frame sync. This signal is qualified with $\overline{CS}$ internally.
+IN	11	I	Noninverting analog input channel
-IN	12	I	Inverting analog input channel
NC	10, 13	–	No connection
PD	28	I	Power down. Device resets and powers down when this signal is high.
REFIN	8	I	Reference (positive) input. REFIN must be decoupled with REFM pin using 0.1- $\mu$ F bypass capacitor and 1- $\mu$ F storage capacitor.
REFM	7	I	Reference ground. To be connected to analog ground plane.
REFOUT	9	O	Internal reference output. Shorted to REFIN pin only when internal reference is used.
SCLK	24	I	Serial clock. Data is shifted onto SDO with the rising edge of this clock. This signal is qualified with $\overline{CS}$ internally.
SDO	23	O	Serial data out. All bits except MSB are shifted out at the rising edge of SCLK.
+VA	3, 6, 14, 16, 17	–	Analog power supplies
+VBD	20	–	Digital power supply for all digital inputs and outputs.

TYPICAL CHARACTERISTICS

SIGNAL-TO-NOISE RATIO  
vs  
REFERENCE VOLTAGE

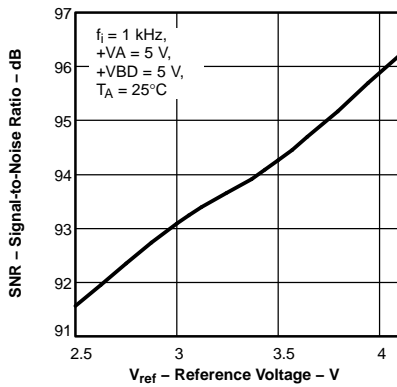

Figure 1.

SIGNAL-TO-NOISE  
AND DISTORTION  
vs  
REFERENCE VOLTAGE

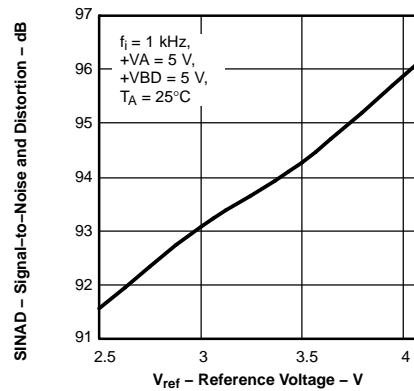

Figure 2.

SPURIOUS FREE DYNAMIC RANGE  
vs  
REFERENCE VOLTAGE

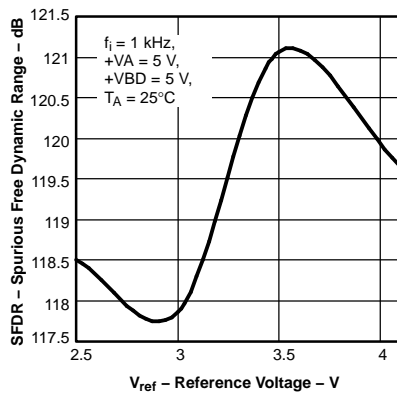

Figure 3.

TOTAL HARMONIC DISTORTION  
vs  
REFERENCE VOLTAGE

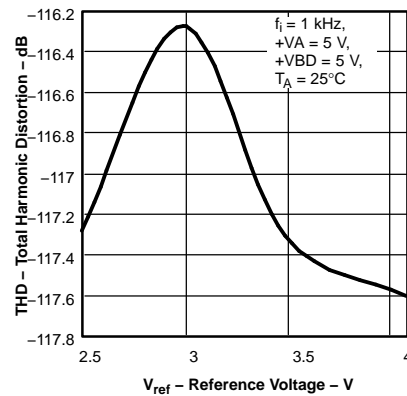

Figure 4.

EFFECTIVE NUMBER OF BITS  
vs  
REFERENCE VOLTAGE

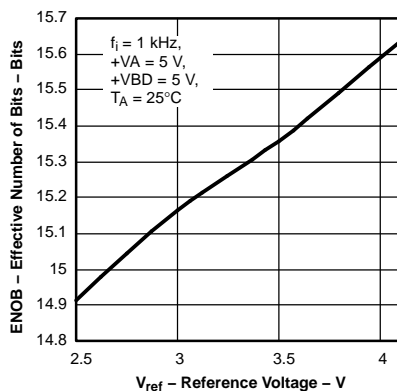

Figure 5.

EFFECTIVE NUMBER OF BITS  
vs  
FREE-AIR TEMPERATURE

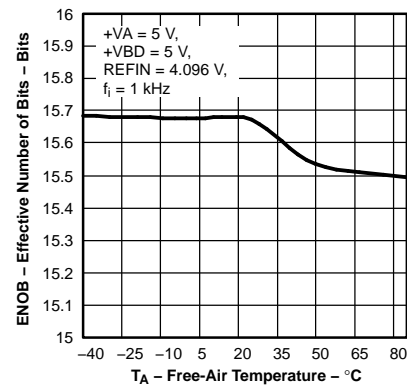

Figure 6.



**TYPICAL CHARACTERISTICS (continued)**

**SIGNAL-TO-NOISE RATIO  
vs  
FREE-AIR TEMPERATURE**

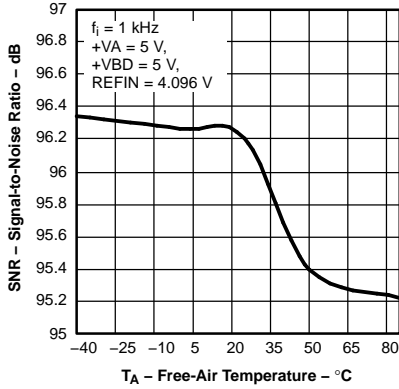

Figure 7.

**SIGNAL-TO-NOISE  
AND DISTORTION  
vs  
FREE-AIR TEMPERATURE**

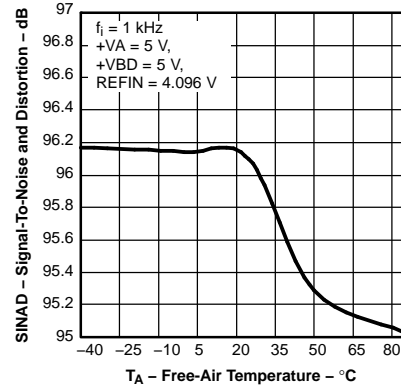

Figure 8.

**SPURIOUS FREE DYNAMIC RANGE  
vs  
FREE-AIR TEMPERATURE**

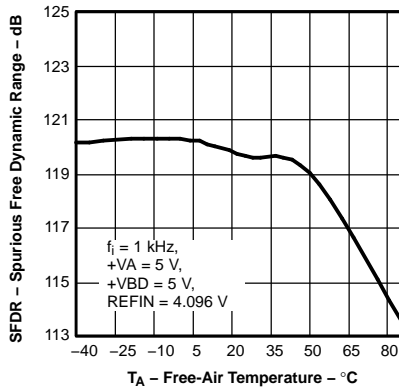

Figure 9.

**TOTAL HARMONIC DISTORTION  
vs  
FREE-AIR TEMPERATURE**

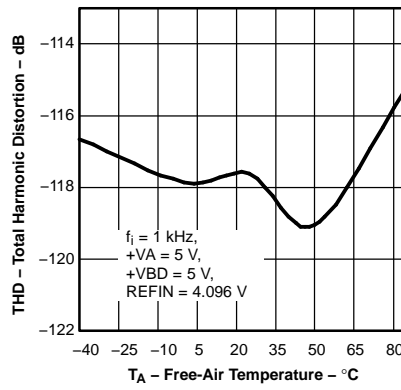

Figure 10.

**EFFECTIVE NUMBER OF BITS  
vs  
INPUT FREQUENCY**

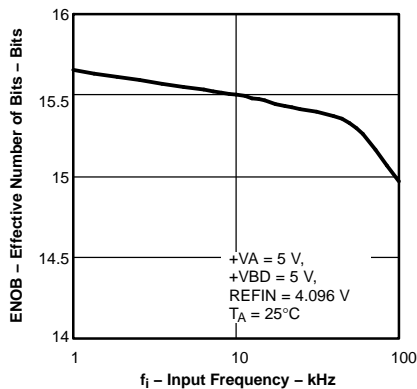

Figure 11.

**SIGNAL-TO-NOISE  
AND DISTORTION  
vs  
INPUT FREQUENCY**

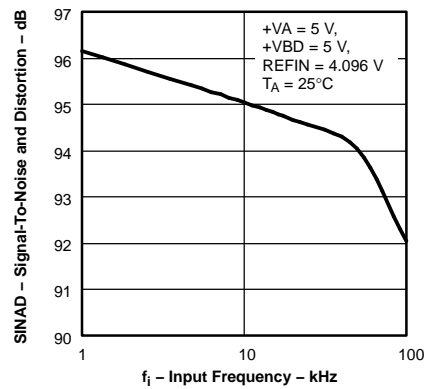
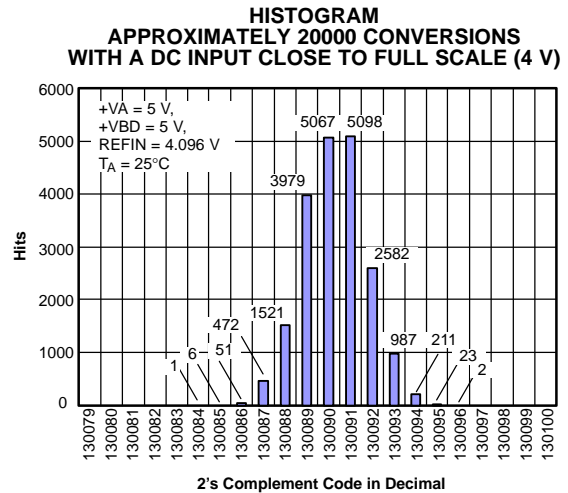
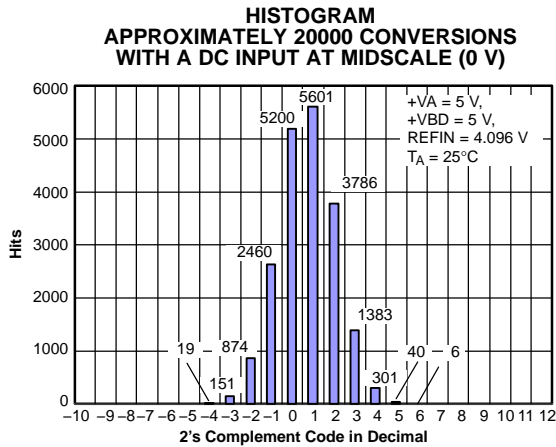
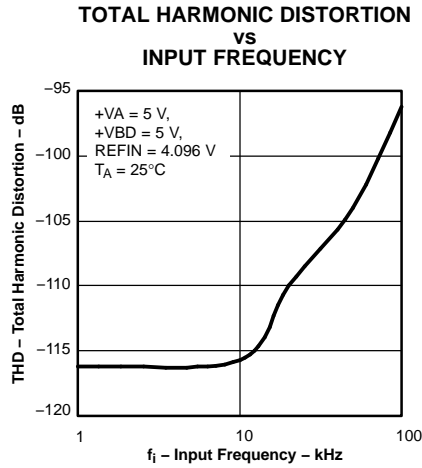
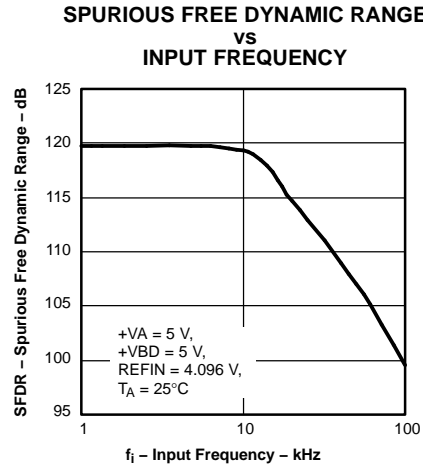
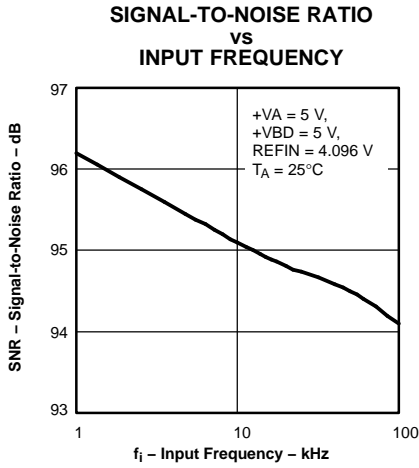

Figure 12.

**TYPICAL CHARACTERISTICS (continued)**



**TYPICAL CHARACTERISTICS (continued)**

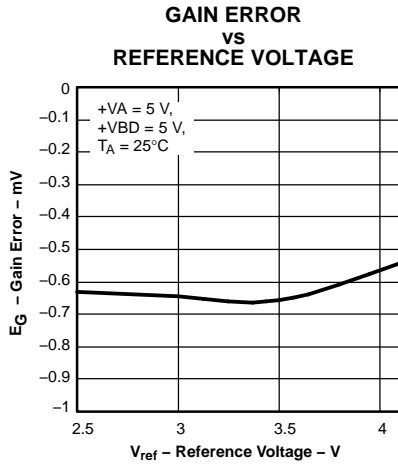

Figure 18.

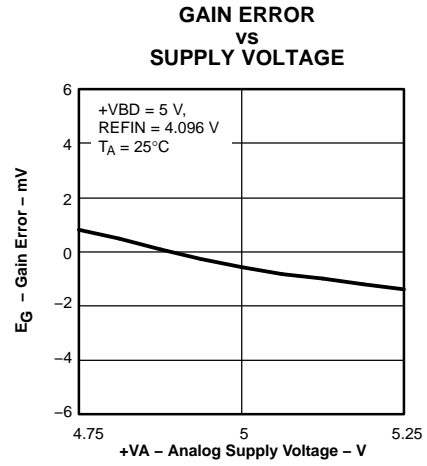

Figure 19.

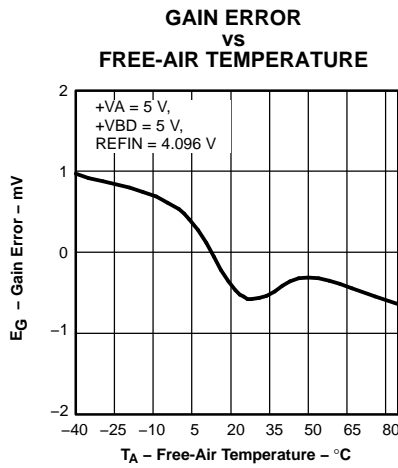

Figure 20.

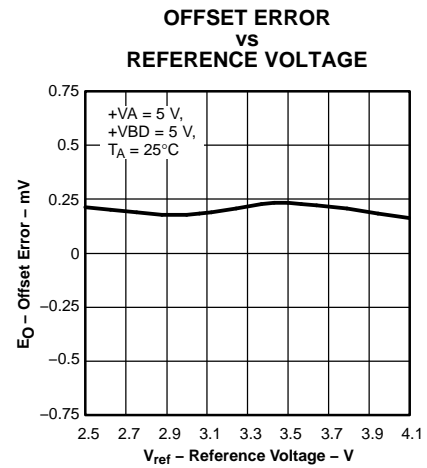

Figure 21.

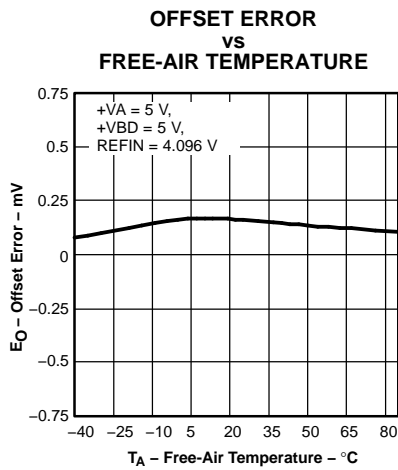

Figure 22.

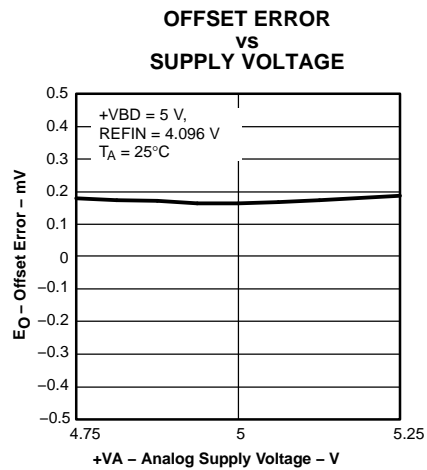
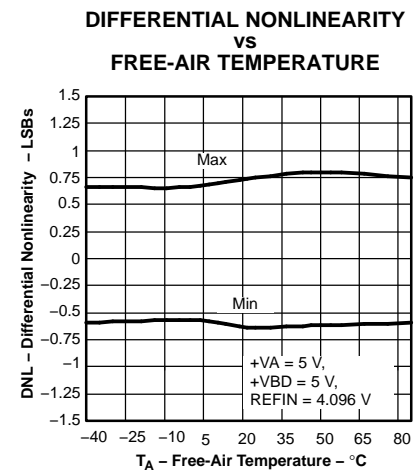
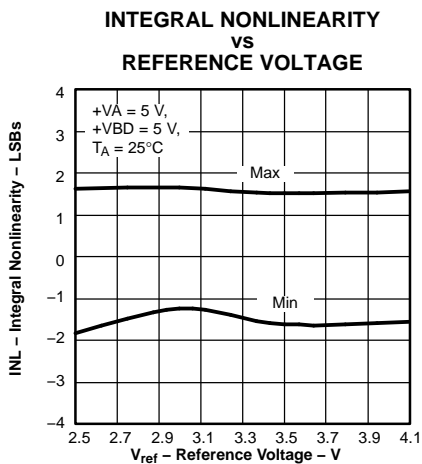
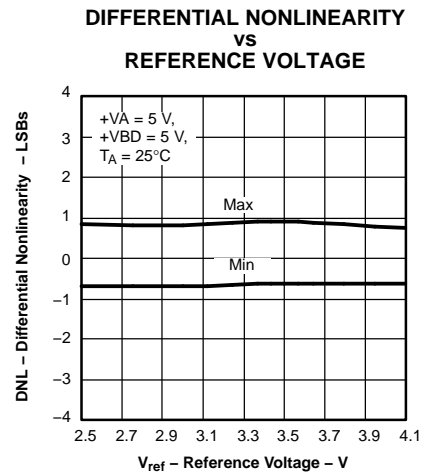
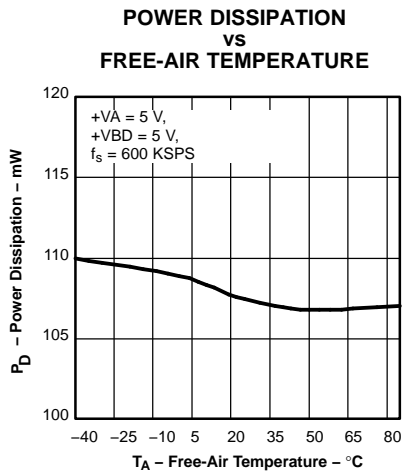
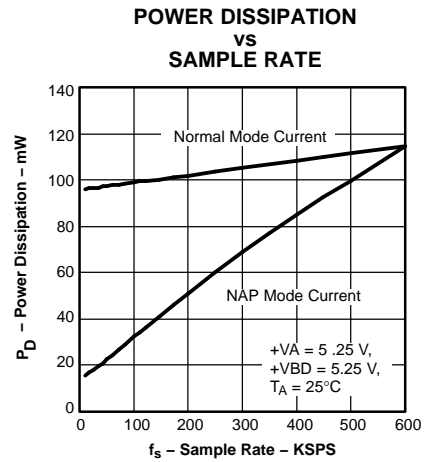
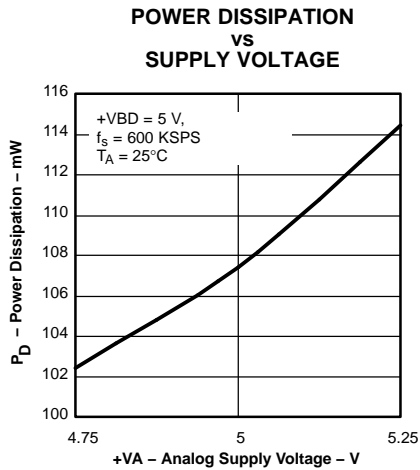
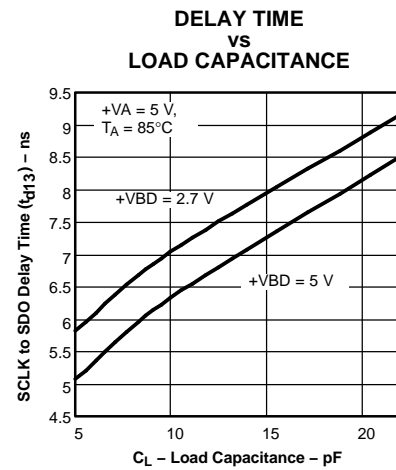
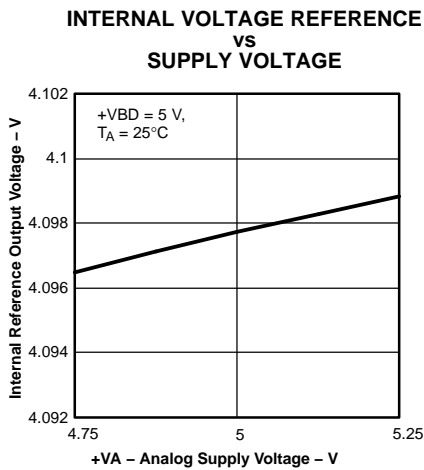
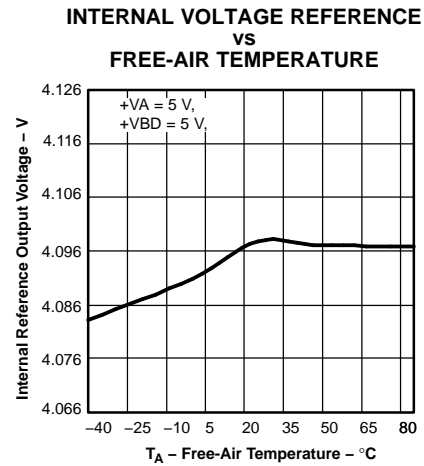
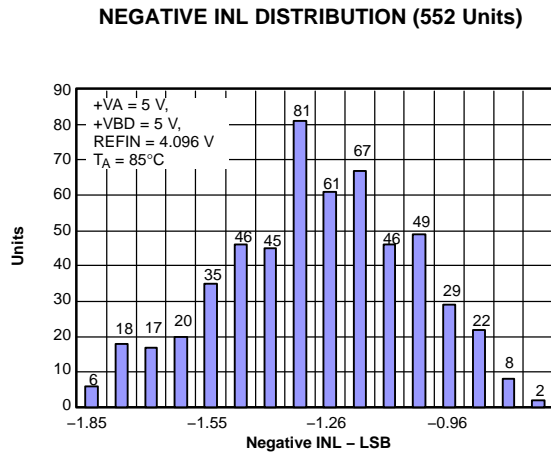
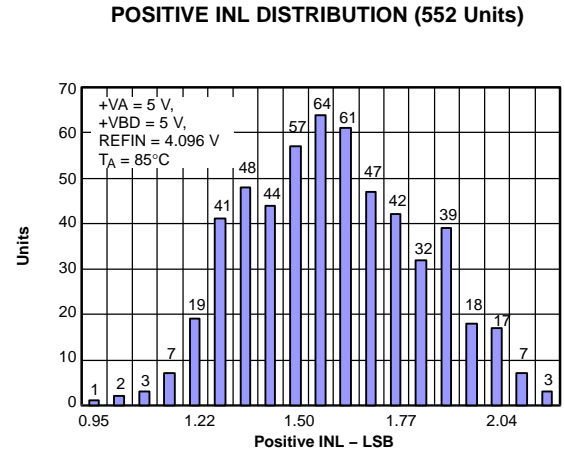
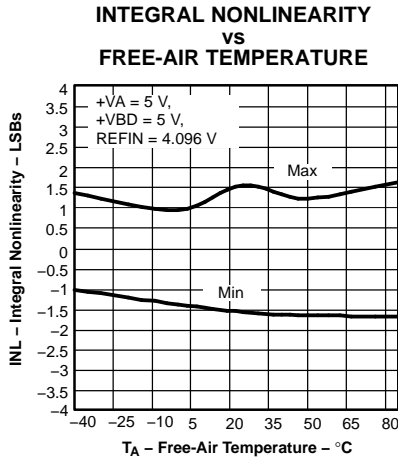

Figure 23.

TYPICAL CHARACTERISTICS (continued)



TYPICAL CHARACTERISTICS (continued)



**TYPICAL CHARACTERISTICS (continued)**

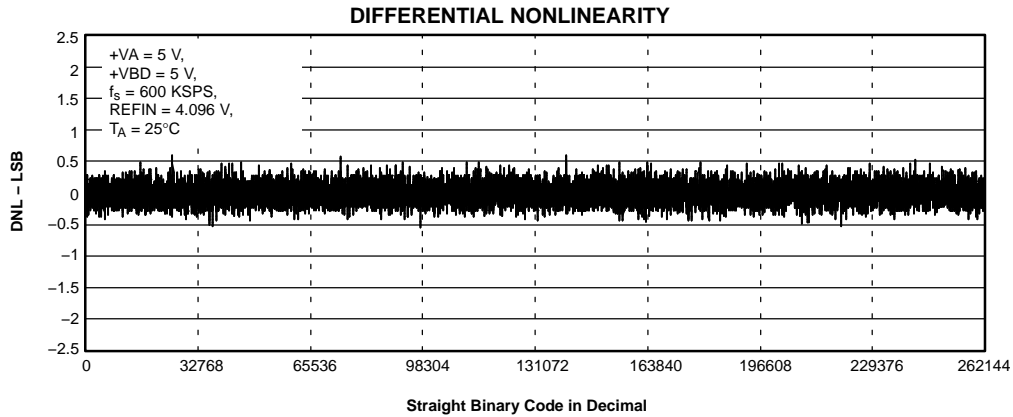

**Figure 36.**

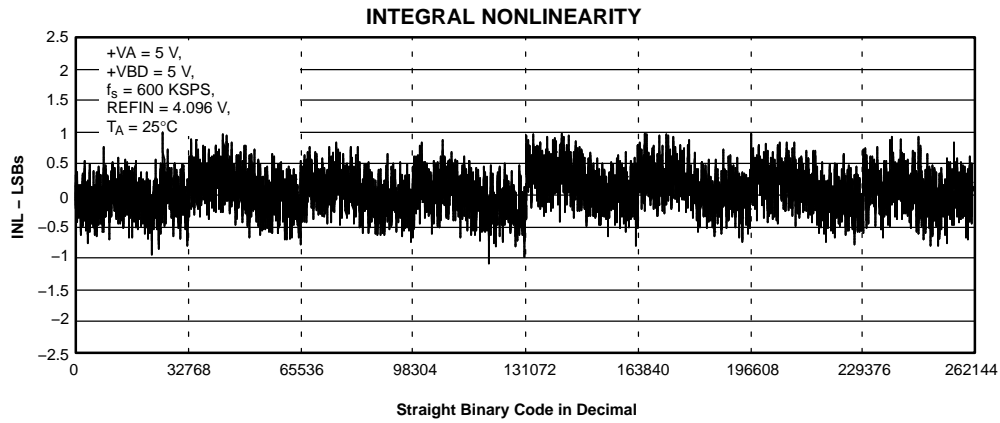

**Figure 37.**

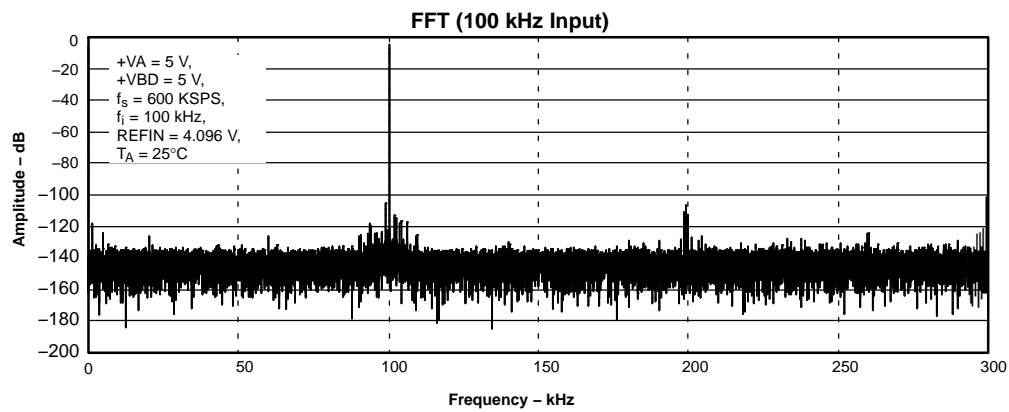

**Figure 38.**

TYPICAL CHARACTERISTICS (continued)

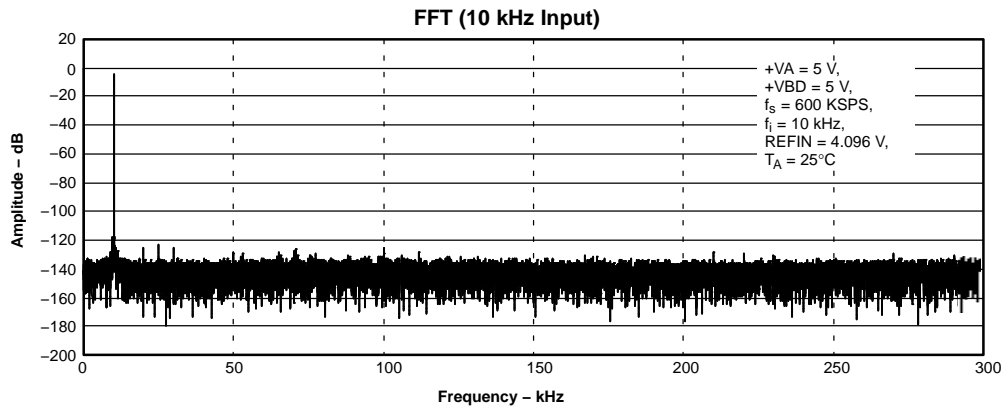
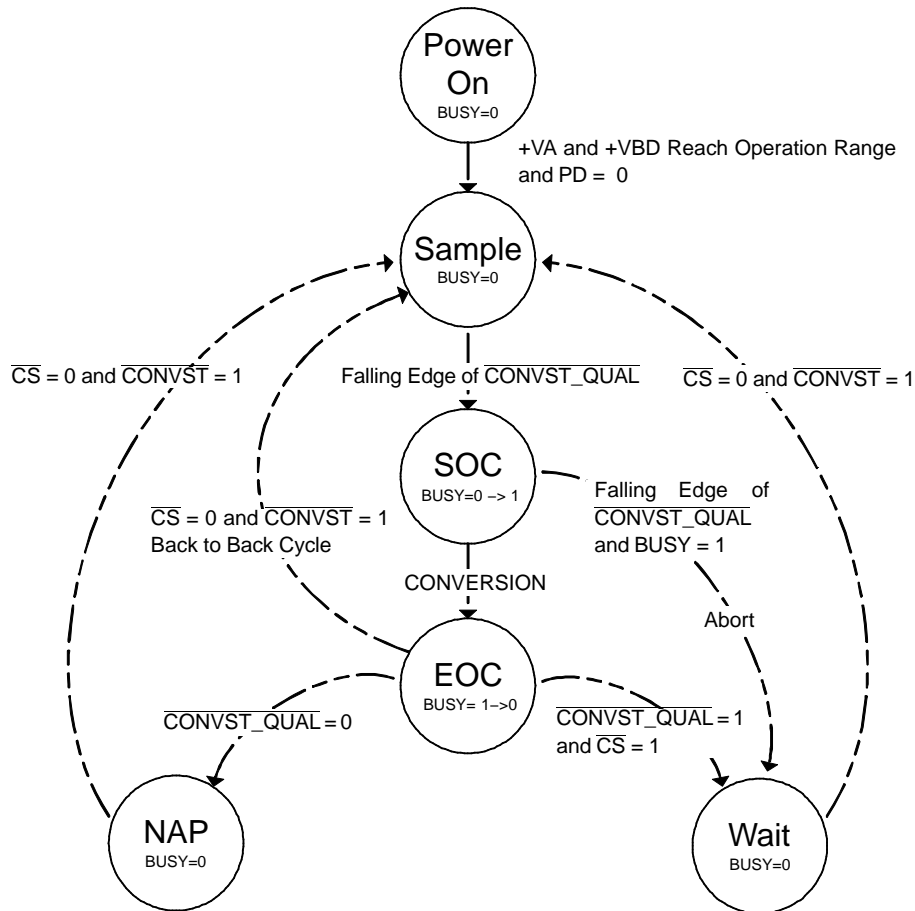

Figure 39.



A. EOC = End of conversion, SOC = Start of conversion,  $\overline{\text{CONVST\_QUAL}}$  is  $\overline{\text{CONVST}}$  latched by  $\overline{\text{CS}} = 0$ , see Figure 41.

Figure 40. Device States and Ideal Transitions

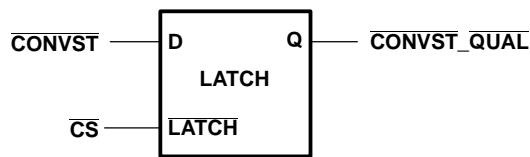

Figure 41. Relationship Between  $\overline{\text{CONVST\_QUAL}}$ ,  $\overline{\text{CS}}$ , and  $\overline{\text{CONVST}}$

**TIMING DIAGRAMS**

In the following descriptions, the signal  $\overline{\text{CONVST\_QUAL}}$  represents  $\overline{\text{CONVST}}$  latched by a low value on  $\overline{\text{CS}}$  (see Figure 41).

To avoid performance degradation, there are three quiet zones to be observed ( $t_{\text{quiet1}}$  and  $t_{\text{quiet2}}$  are zones before and after the falling edge of  $\overline{\text{CONVST\_QUAL}}$  while  $t_{\text{quiet3}}$  is a time zone before the falling edge of  $\text{BUSY}$ ) where there should be no I/O activities. Interface control signals, including the serial clock should remain steady. Typical degradation in performance if these quiet zones are not observed is depicted in the specifications section.

To avoid data loss a read operation should not start around the  $\text{BUSY}$  falling edge. This is constrained by  $t_{\text{su2}}$ ,  $t_{\text{su3}}$ ,  $t_{\text{h2}}$ , and  $t_{\text{h8}}$ .

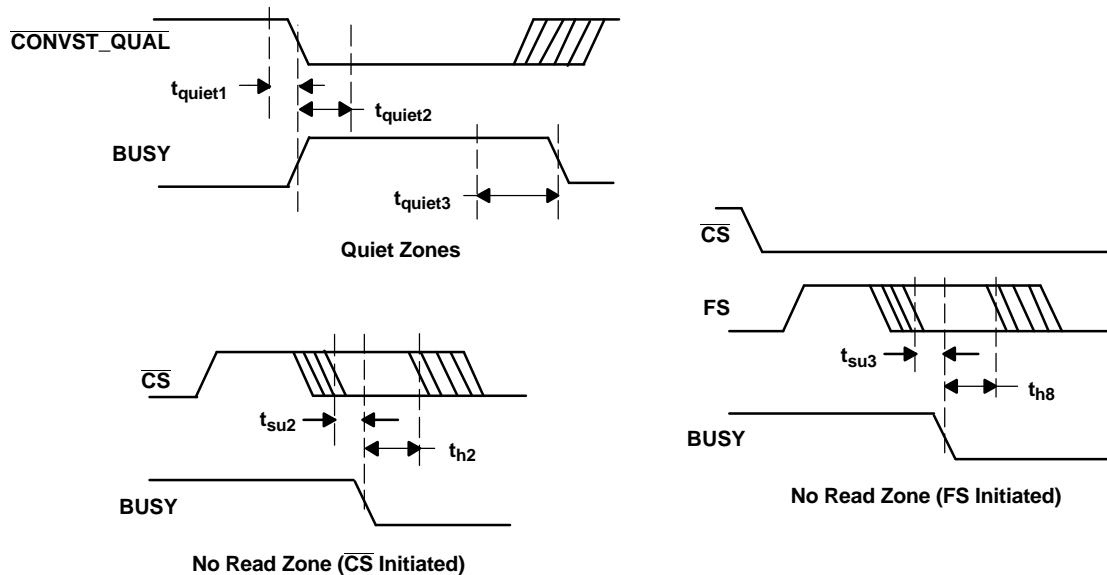

Figure 42. Quiet Zones and No-Read Zones

**CONVERSION AND SAMPLING**

1. Convert start command:

The device enters the conversion phase from the sampling phase when a falling edge is detected on  $\overline{\text{CONVST\_QUAL}}$ . This is shown in Figure 43, Figure 44, and Figure 45.

2. Sample (acquisition) start command:

The device starts sampling from the wait/nap state or at the end of a conversion if  $\overline{\text{CONVST}}$  is detected as high and  $\overline{\text{CS}}$  as low. This is shown in Figure 43, Figure 44, and Figure 45.

Maintaining this condition (holding  $\overline{\text{CS}}$  low) when the device has just finished a conversion (as shown in Figure 43) takes the device immediately into the sampling phase after the conversion phase (back-to-back conversion) and hence achieves the maximum throughput. Otherwise, the device enters the wait state or the nap state.



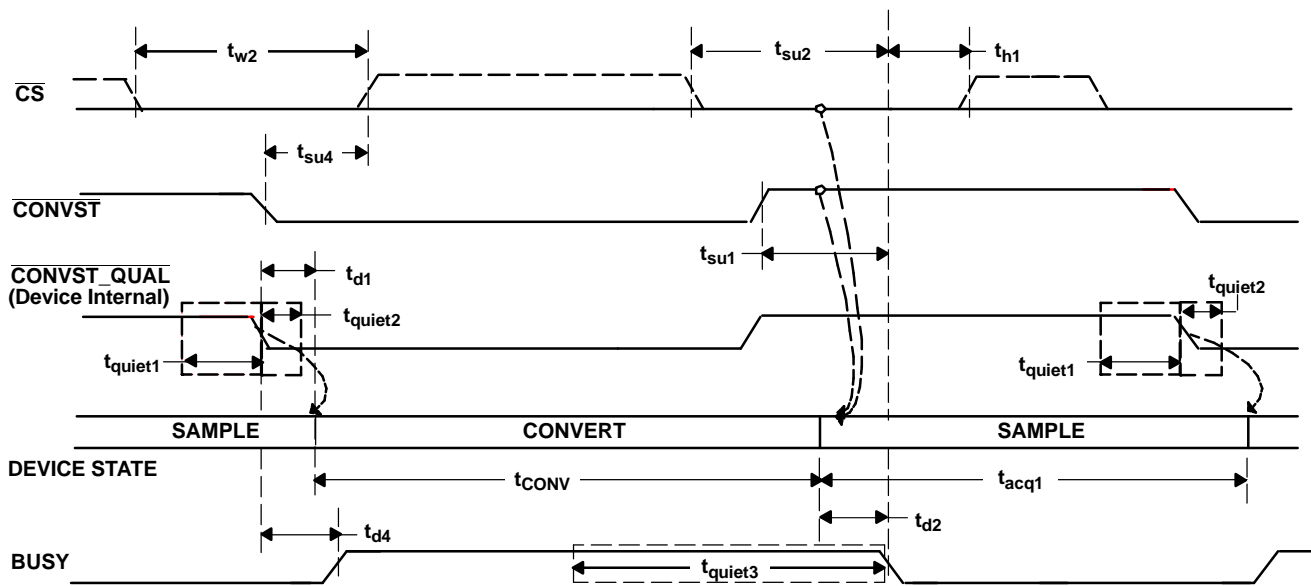

Figure 43. Back-to-Back Conversion and Sample

3. Wait/Nap entry stimulus:

The device enters the wait or nap phase at the end of the conversion if the sample start command is not given. This is shown in Figure 44.

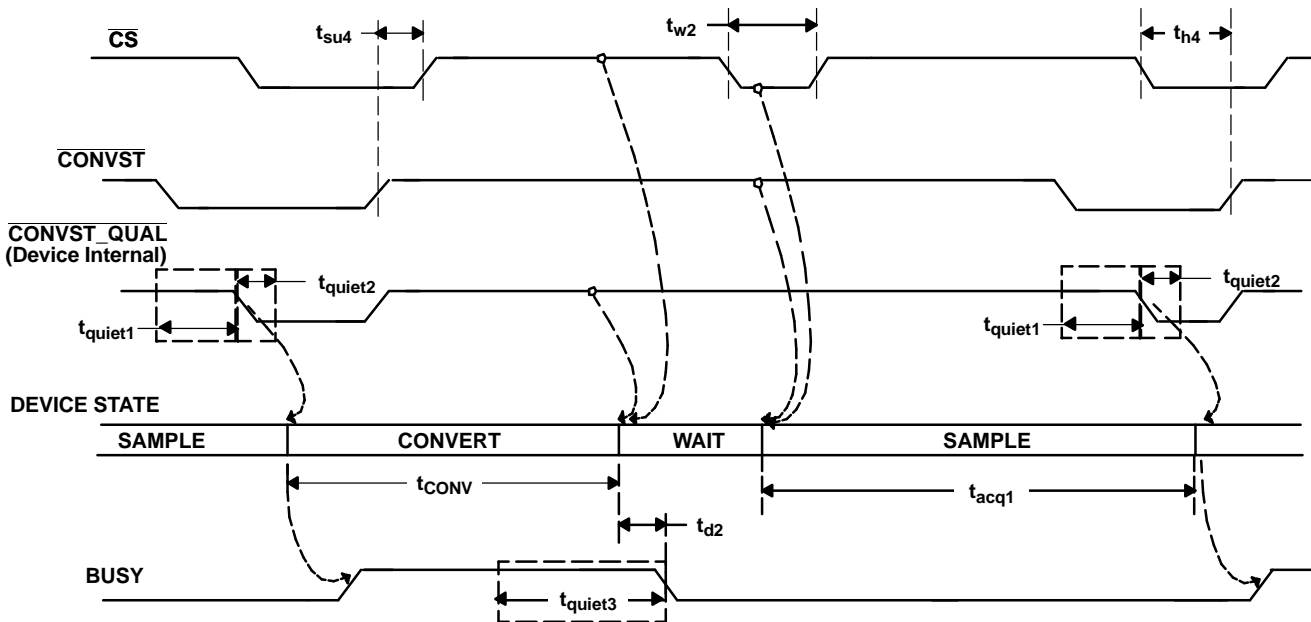
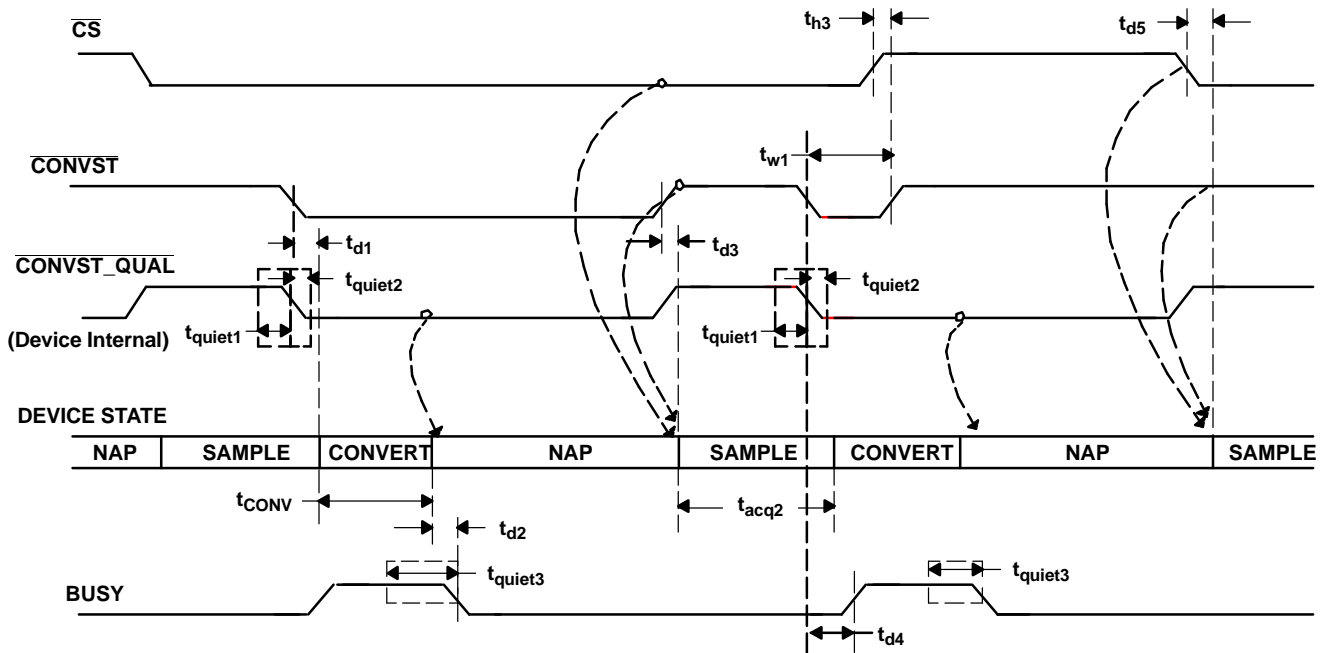

Figure 44. Convert and Sample with Wait

If lower power dissipation is desired and throughput can be compromised, a nap state can be inserted in between cycles (as shown in Figure 45). The device enters a low power (3 mA) state called nap if the end of the conversion happens when CONVST\_QUAL is low. The cost for using this special wait state is a longer sampling time ( $t_{acq2}$ ) plus the nap time.



**Figure 45. Convert and Sample with Nap**

4. Conversion abort command:

An ongoing conversion can be aborted by using the conversion abort command. This is done by forcing another start of conversion (a valid CONVST\_QUAL falling edge) onto an ongoing conversion as shown in [Figure 46](#). The device enters the wait state after an aborted conversion. If the previous conversion was successfully aborted, the device output reads 0x3FC00 on SDO.

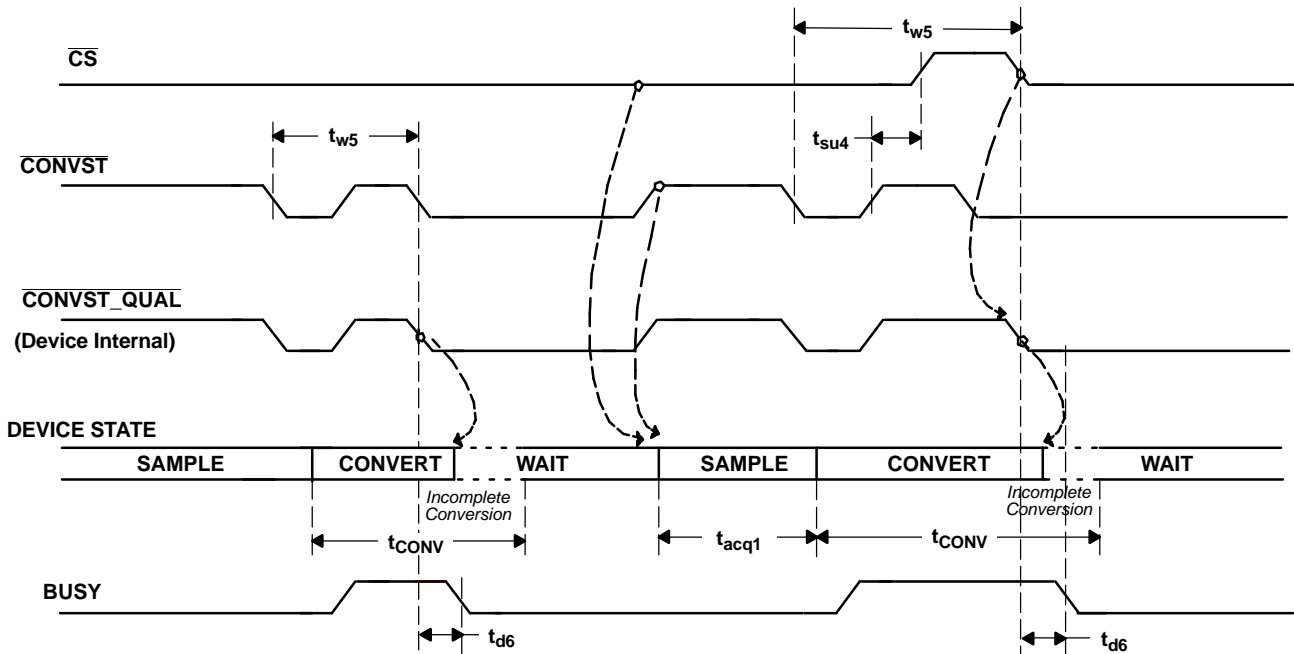

**Figure 46. Conversion Abort**

## DATA READ OPERATION

Data read control is independent of conversion control. Data can be read either during conversion or during sampling. Data that is read during a conversion involves latency of one sample. The start of a new data frame around the fall of  $\overline{\text{BUSY}}$  is constrained by  $t_{\text{su}2}$ ,  $t_{\text{su}3}$ ,  $t_{\text{h}2}$ , and  $t_{\text{h}8}$ .

### 1. SPI interface:

A data read operation in SPI interface mode is shown in Figure 47.  $\overline{\text{FS}}$  must be tied high for operating in this mode. The MSB of the output data is available at the falling edge of  $\overline{\text{CS}}$ . MSB – 1 is shifted out at the first rising edge after the first falling edge of SCLK after  $\overline{\text{CS}}$  falling edge. Subsequent bits are shifted at the subsequent rising edges of SCLK. If another data frame is attempted (by pulling  $\overline{\text{CS}}$  high and subsequently low) during an active data frame, then the ongoing frame is aborted and a new frame is started.

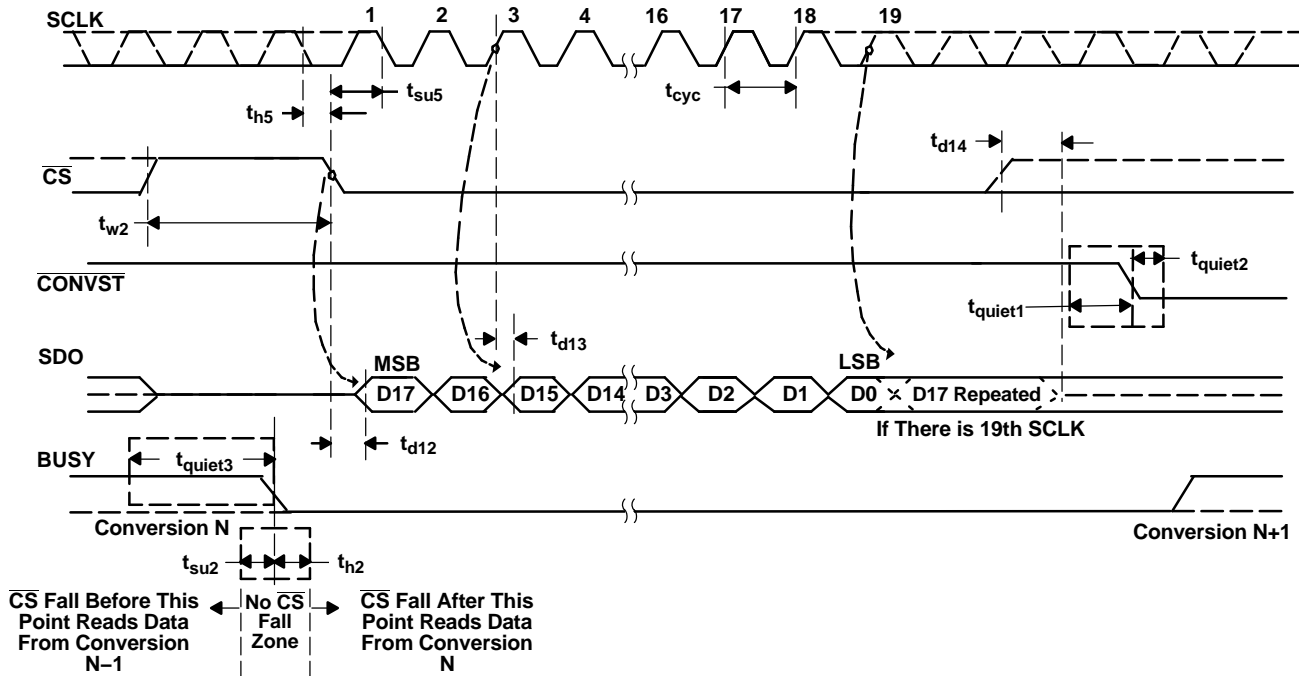

Figure 47. Read Frame Controlled via  $\overline{\text{CS}}$  (FS = 1)

If another data frame is attempted (by pulling  $\overline{\text{CS}}$  high and then low) during an active data frame, then the ongoing frame is aborted and a new frame is started.

### 2. Serial interface using FS:

A data read operation in this mode is shown in Figure 48 and Figure 49. The MSB of the output data is available at the rising edge of FS. MSB – 1 is shifted out at the first rising edge after the first falling edge of SCLK after the FS falling edge. Subsequent bits are shifted at the subsequent rising edges of SCLK.

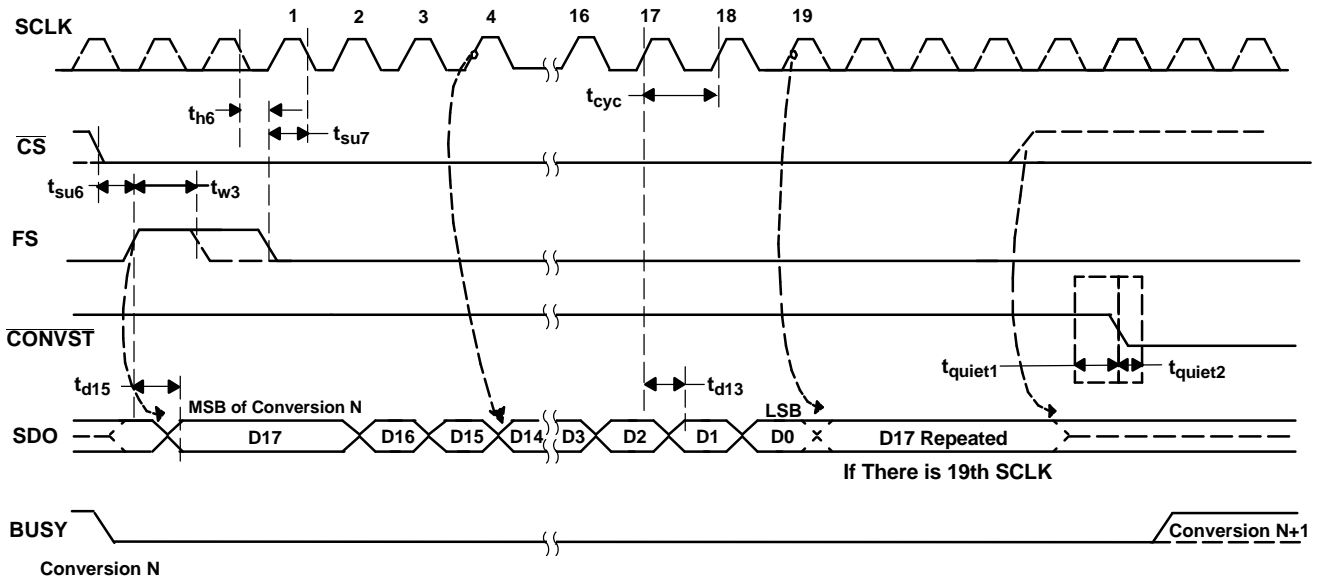

Figure 48. Read Frame Controlled via FS (FS is Low When BUSY Falls)

If FS is high when BUSY falls, the SDO is updated again with the new MSB when BUSY falls. This is shown in Figure 49.

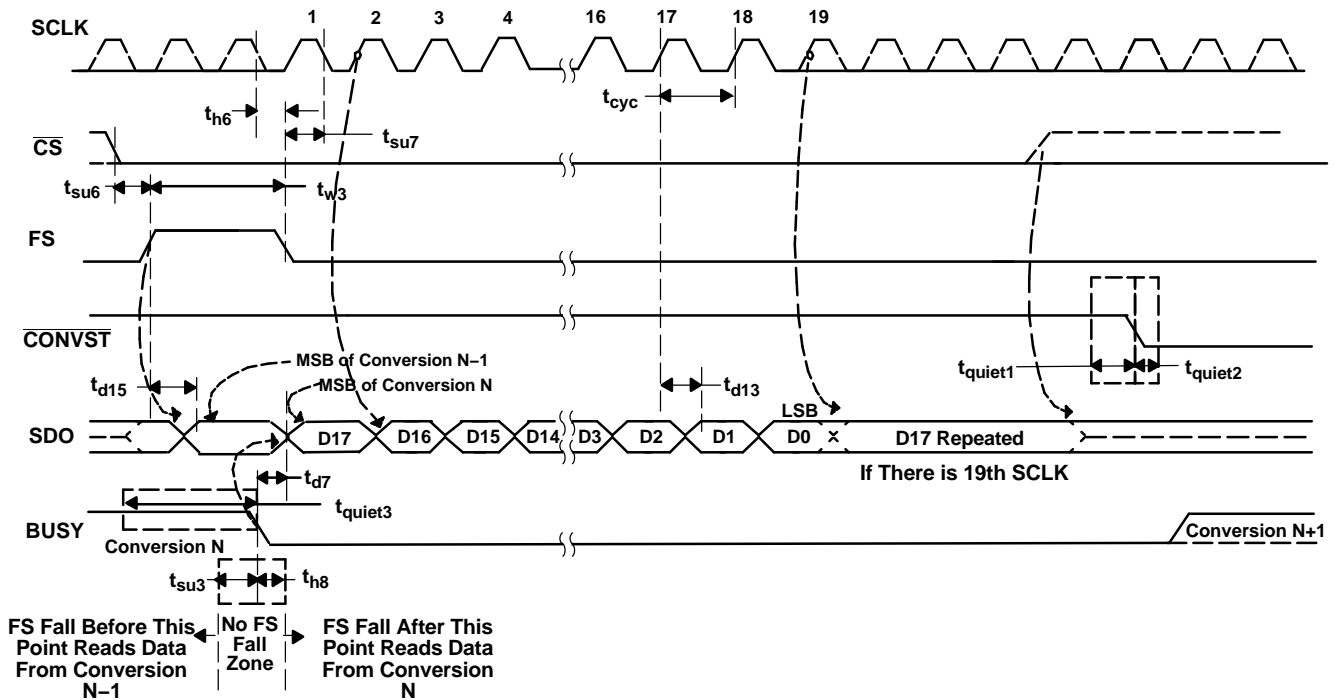

Figure 49. Read Frame Controlled via FS (FS is High When BUSY Falls)

If another data frame is attempted by pulling up FS during an active data frame, then the ongoing frame is aborted and a new frame is started.

## THEORY OF OPERATION

The ADS8382 is a high-speed successive approximation register (SAR) analog-to-digital converter (ADC). The architecture is based on charge redistribution, which inherently includes a sample/hold function.

The device includes a built-in conversion clock, internal reference, and 40-MHz SPI compatible serial interface. The maximum conversion time is 1.1  $\mu\text{s}$  which is capable of sustaining a 600-kHz throughput.

The analog input is provided to the two input pins: +IN and –IN. When a conversion is initiated, the differential input on these pins is sampled on the internal capacitor array. While a conversion is in progress, both inputs are disconnected from any internal function.

## REFERENCE

The ADS8382 has a built-in 4.096-V (nominal value) reference but can operate with an external reference also. When the internal reference is used, pin 9 (REFOUT) should be shorted to pin 8 (REFIN) and a 0.1- $\mu\text{F}$  decoupling capacitor and a 1- $\mu\text{F}$  storage capacitor must be connected between pin 8 (REFIN) and pin 7 (REFM) (see [Figure 50](#)). The internal reference of the converter is buffered.

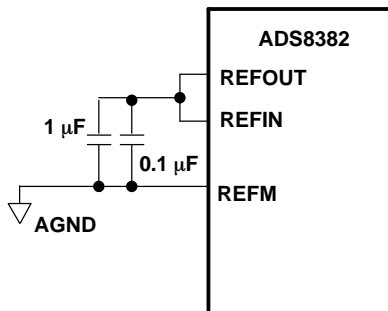

**Figure 50. ADS8382 Using Internal Reference**

The REFIN pin is also internally buffered. This eliminates the need to put a high bandwidth buffer on the board to drive the ADC reference and saves system area and power. When an external reference is used, the reference must be of low noise, which may be achieved by the addition of bypass capacitors from the REFIN pin to the REFM pin. See [Figure 51](#) for operation of the ADS8382 with an external reference. REFM must be connected to the analog ground plane.

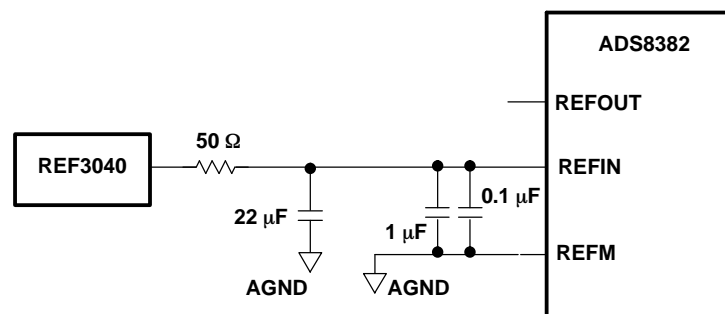

**Figure 51. ADS8382 Using External Reference**

**THEORY OF OPERATION (continued)**

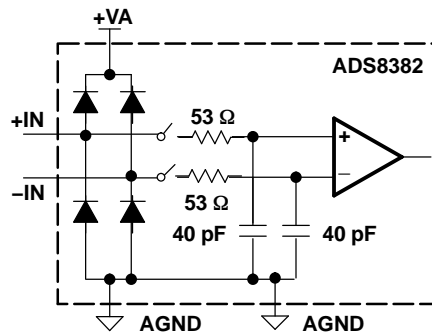

**Figure 52. Simplified Analog Input**

**ANALOG INPUT**

When the converter enters hold mode, the voltage difference between the +IN and –IN inputs is captured on the internal capacitor array. Both the +IN and –IN inputs have a range of –0.2 V to (+V<sub>REF</sub> + 0.2 V). The input span (+IN – (–IN)) is limited from –V<sub>REF</sub> to V<sub>REF</sub>.

The input current on the analog inputs depends upon throughput and the frequency content of the analog input signals. Essentially, the current into the ADS8382 charges the internal capacitor array during the sampling (acquisition) time. After this capacitance has been fully charged, there is no further input current. The source of the analog input voltage must be able to charge the device sampling capacitance (40 pF each from +IN–IN to AGND) to an 18-bit settling level within the sampling (acquisition) time of the device. When the converter goes into hold mode, the input resistance is greater than 1 GΩ.

Care must be taken regarding the absolute analog input voltage. To maintain the linearity of the converter, the +IN, –IN inputs and the span (+IN – (–IN)) should be within the limits specified. Outside of these ranges, the converter’s linearity may not meet specifications.

Care should be taken to ensure that the output impedance of the sources driving +IN and –IN inputs are matched. If this is not observed, the two inputs can have different settling times. This can result in offset error, gain error, and linearity error which vary with temperature and input voltage.

A typical input circuit using TI’s THS4031 is shown in [Figure 53](#). In the figure, input from a single-ended source is converted into a differential signal for the ADS8382. In the case where the source is differential, the circuit in [Figure 54](#) may be used. Most of the specified performance figure were measured using the circuit in [Figure 54](#).

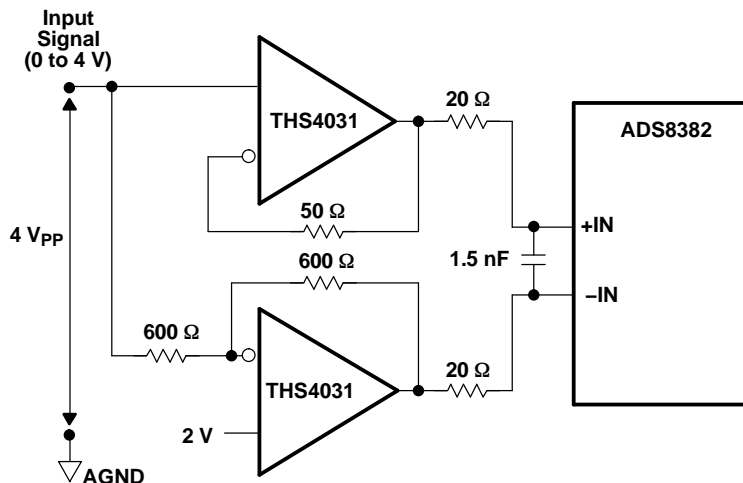

**Figure 53. Single-Ended Input, Differential Output Configuration**

## THEORY OF OPERATION (continued)

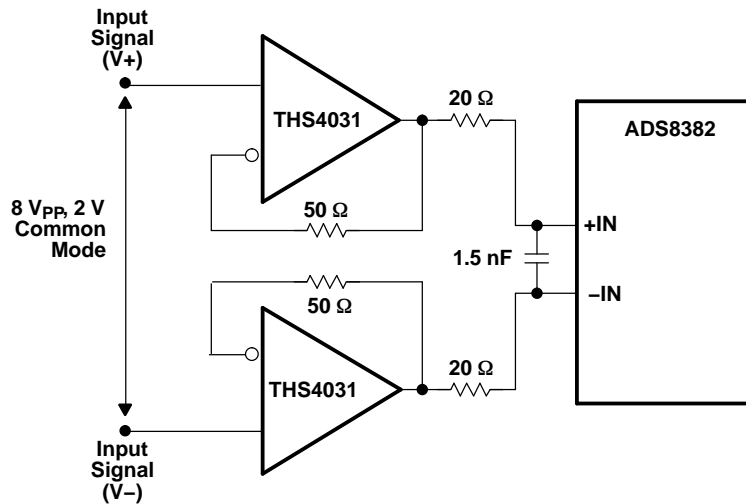

Figure 54. Differential Input, Differential Output Configuration

## DIGITAL INTERFACE

### TIMING AND CONTROL

Conversion and sampling are controlled by the  $\overline{\text{CONVST}}$  and  $\overline{\text{CS}}$  pins. See the timing diagrams for detailed information on timing signals and their requirements. The ADS8382 uses an internally generated clock to control the conversion rate and in turn the throughput of the converter. SCLK is used for reading converted data only. A clean and low jitter conversion start command is important for the performance of the converter. There is a minimal quiet zone requirement around the conversion start command as mentioned in the timing requirements table.

### READING DATA

The ADS8382 offers a high speed serial interface that is compatible with the SPI protocol. The device outputs the data in 2's complement format. Refer to Table 1 for the ideal output codes.

Table 1. Input Voltages and Ideal Output Codes

DESCRIPTION	ANALOG VALUE +IN – (–IN)	DIGITAL OUTPUT (HEXADECIMAL)
Full-scale range	$2(+V_{\text{REF}})$	
Least significant bit (LSB)	$2(+V_{\text{REF}})/2^{18}$	
Full scale	$V_{\text{REF}} - 1 \text{ LSB}$	1FFFF
Mid scale	0	00000
Mid scale – 1 LSB	$0 \text{ V} - 1 \text{ LSB}$	3FFFF
–Full scale	$-V_{\text{REF}}$	20000

To avoid performance degradation due to the toggling of device buffers, read operation must not be performed in the specified quiet zones ( $t_{\text{quiet}1}$ ,  $t_{\text{quiet}2}$ , and  $t_{\text{quiet}3}$ ). Internal to the device, the previously converted data is updated with the new data near the fall of BUSY. Hence, the fall of  $\overline{\text{CS}}$  and the fall of FS around the fall of BUSY is constrained. This is specified by  $t_{\text{su}2}$ ,  $t_{\text{su}3}$ ,  $t_{\text{h}2}$ , and  $t_{\text{h}8}$  in the timing requirements table.

### POWER SAVING

The converter provides two power saving modes, full power down and nap. Refer to Table 2 for information on activation/deactivation and resumption time for both modes.

**Table 2. Power Save**

TYPE OF POWER DOWN	SDO	POWER CONSUMPTION	ACTIVATED BY	ACTIVATION TIME ( $t_{d16}$ )	RESUME POWER BY
Normal operation	Not 3 stated	22 mA	NA	NA	NA
Full power down (Int Ref, 1- $\mu$ F capacitor on REFOUT pin)	3 Stated ( $t_{d10}$ timing)	2 $\mu$ A	PD = 1	10 $\mu$ s	PD = 0
Full power down (Ext Ref, 1- $\mu$ F capacitor on REFOUT pin)	3 Stated ( $t_{d10}$ timing)	2 $\mu$ A	PD = 1	10 $\mu$ s	PD = 0
Nap power down	Not 3 stated	3 mA	At EOC and CONVST_QUAL = 0	200 ns	Sample Start command

**FULL POWER-DOWN MODE**

Full power-down mode is activated by turning off the supply or by asserting PD to 1. See [Figure 55](#) and [Figure 56](#). The device can be resumed from full power down by either turning on the power supply or by de-asserting the PD pin. The first two conversions produce inaccurate results because during this period the device loads its trim values to ensure the specified accuracy.

If an internal reference is used (with a 1- $\mu$ F capacitor installed between the REFOUT and REFM pins), the total resume time ( $t_{d18}$ ) is 25 ms. After the first two conversions,  $t_{d17}$  (4 ms) is required for the trimmed internal reference voltage to settle to the specified accuracy. Only then the converted results match the specified accuracy.

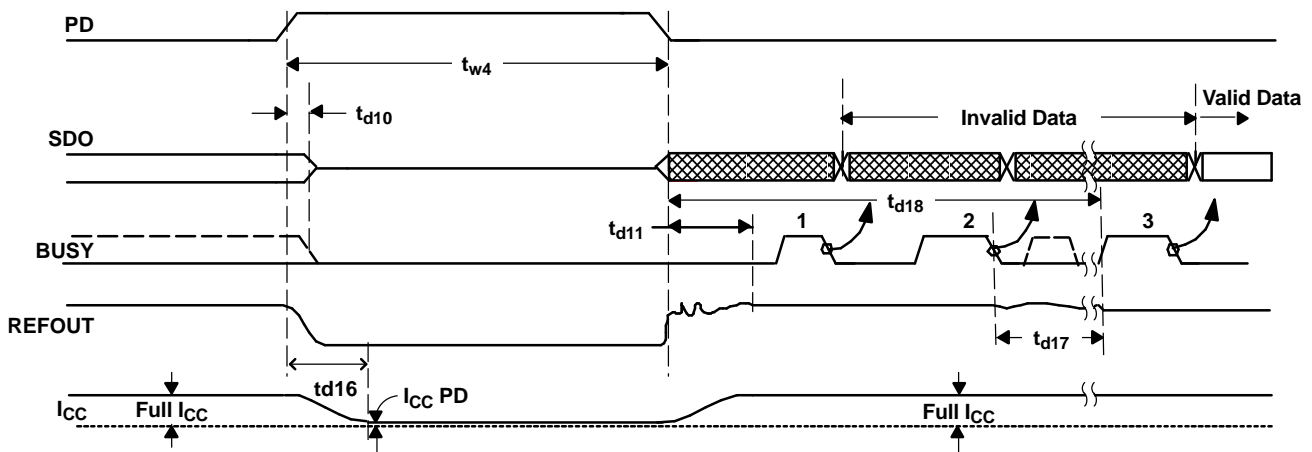

**Figure 55. Device Full Power Down/Resume (Internal Reference Used)**

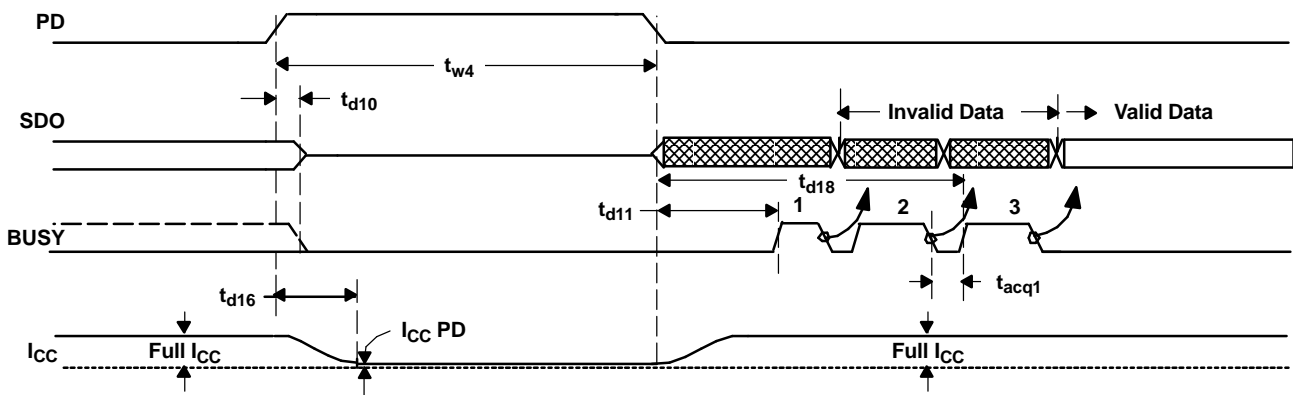

**Figure 56. Device Full Power Down/Resume (External Reference Used)**



## NAP MODE

Nap mode is automatically inserted at the end of a conversion if  $\overline{\text{CONVST\_QUAL}}$  is held low at EOC. The device can be operated in nap mode at the end of every conversion for saving power at lower throughputs. Another way to use this mode is to convert multiple times and then enter nap mode. The minimum sampling time after a nap state is  $t_{\text{acq1}} + t_{\text{d18}} = t_{\text{acq2}}$ .

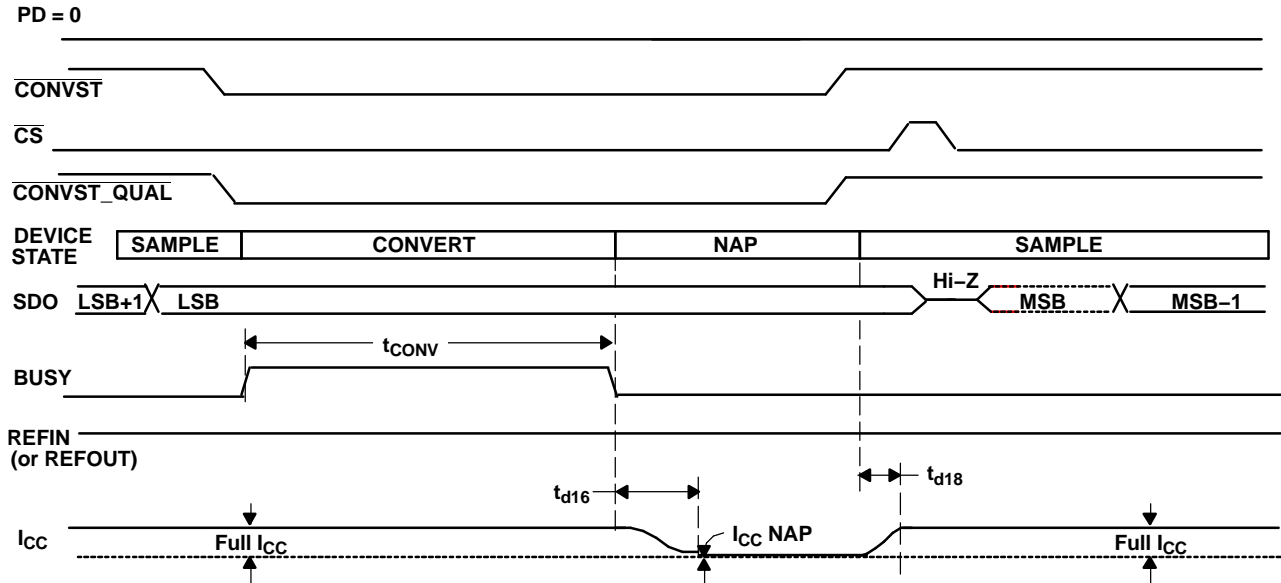

Figure 57. Device Nap Power Down/Resume

## LAYOUT

For optimum performance, care should be taken with the physical layout of the ADS8382 circuitry.

Since the ADS8382 offers single-supply operation, it is often used in close proximity with digital logic, microcontrollers, microprocessors, and digital signal processors. The more the digital logic in the design and the higher the switching speed, the greater the need for better layout and isolation of the critical analog signals from these switching digital signals.

The basic SAR architecture is sensitive to glitches or sudden changes on the power supply, reference, ground connections and digital inputs that occur just prior to the end of sampling and just prior to the latching of the analog comparator. Such glitches might originate from switching power supplies, nearby digital logic, or high power devices. Noise during the end of sampling and the latter half of the conversion must be kept to a minimum (the former half of the conversion is not very sensitive since the device uses a proprietary error correction algorithm to correct for the transient errors made here).

The degree of error in the digital output depends on the reference voltage, layout, and the exact timing and degree of the external event.

On average, the ADS8382 draws very little current from an external reference as the reference voltage is internally buffered. If the reference voltage is external, it must be ensured that the reference source can drive the bypass capacitor without oscillation. A 0.1- $\mu\text{F}$  bypass capacitor is recommended from pin 8 directly to pin 7 (REFM).

The AGND and BDGND pins should be connected to a clean ground point. In all cases, this should be the *analog* ground. Avoid connections that are too close to the grounding point of a microcontroller or digital signal processor. If required, run a ground trace directly from the converter to the power supply entry point. The ideal layout consists of an analog ground plane dedicated to the converter and associated analog circuitry.

**LAYOUT (continued)**

As with the AGND connections, +VA should be connected to a +5-V power-supply plane or trace that is separate from the connection for digital logic until they are connected at the power entry point. Power to the ADS8382 should be clean and well bypassed. A 0.1- $\mu$ F ceramic bypass capacitor should be placed as close to the device as possible. See [Table 3](#) for the placement of these capacitors. In addition, a 1- $\mu$ F capacitor is recommended. In some situations, additional bypassing may be required, such as a 100- $\mu$ F electrolytic capacitor or even a *Pi* filter made up of inductors and capacitors—all designed to essentially low-pass filter the +5-V supply, removing the high frequency noise.

**Table 3. Power Supply Decoupling Capacitor Placement**

SUPPLY PINS	CONVERTER ANALOG SIDE	CONVERTER DIGITAL SIDE
Pair of pins requiring a shortest path to decoupling capacitors	(2,3); (5,6); (15,16); (17,18)	(20,21)
Pins requiring no decoupling	1, 4, 14, 19	

When using the internal reference, ensure a shortest path from REFOUT (pin 9) to REFIN (pin 8) with the bypass capacitor directly between pins 8 and 7.

## APPLICATION INFORMATION

### EXAMPLE DIGITAL STIMULUS

The use of the ADS8382 is very straightforward. The following timing diagram shows one example of how to achieve a 600-KSPS throughput using a SPI compatible serial interface.

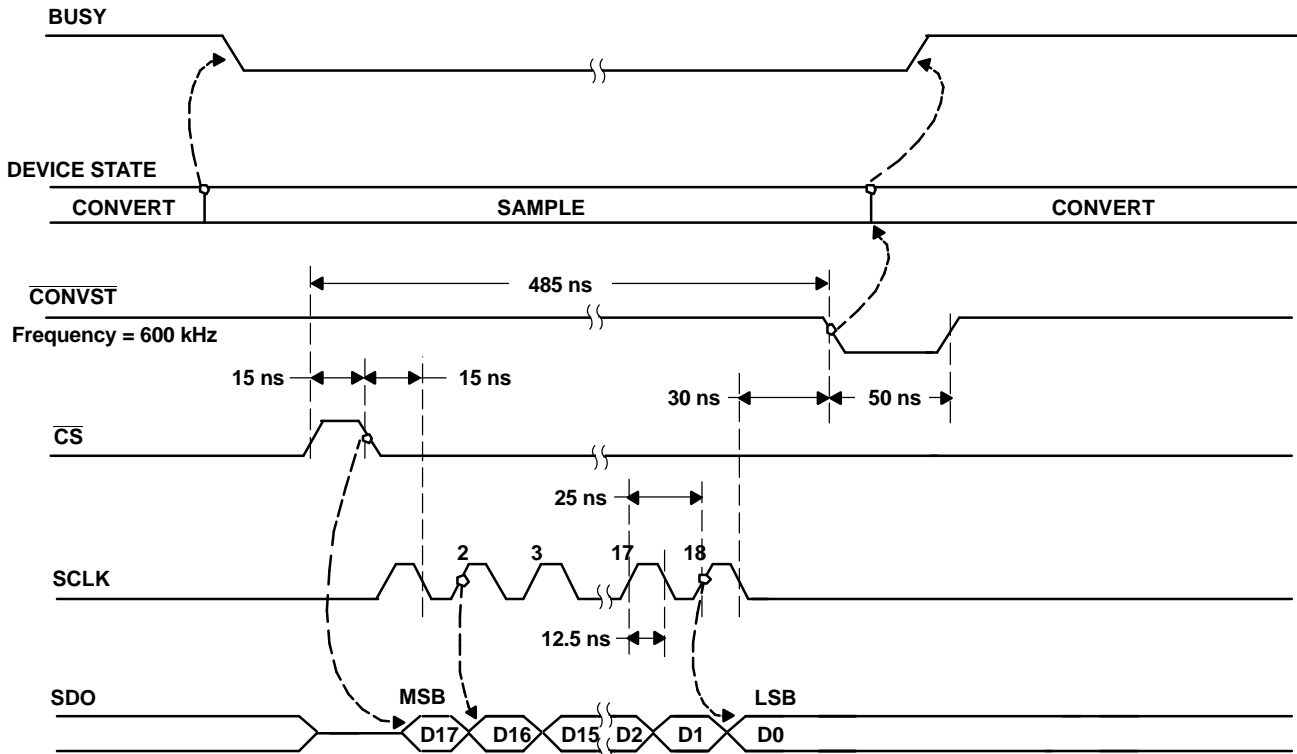

**Figure 58. Example Stimulus in SPI Mode (FS = 1), Back-To-Back Conversion that Achieves 600 KSPS**

It is also possible to use the frame sync signal, FS. The following timing diagram shows how to achieve a 600-KSPS throughput using a modified serial interface with FS active.

APPLICATION INFORMATION (continued)

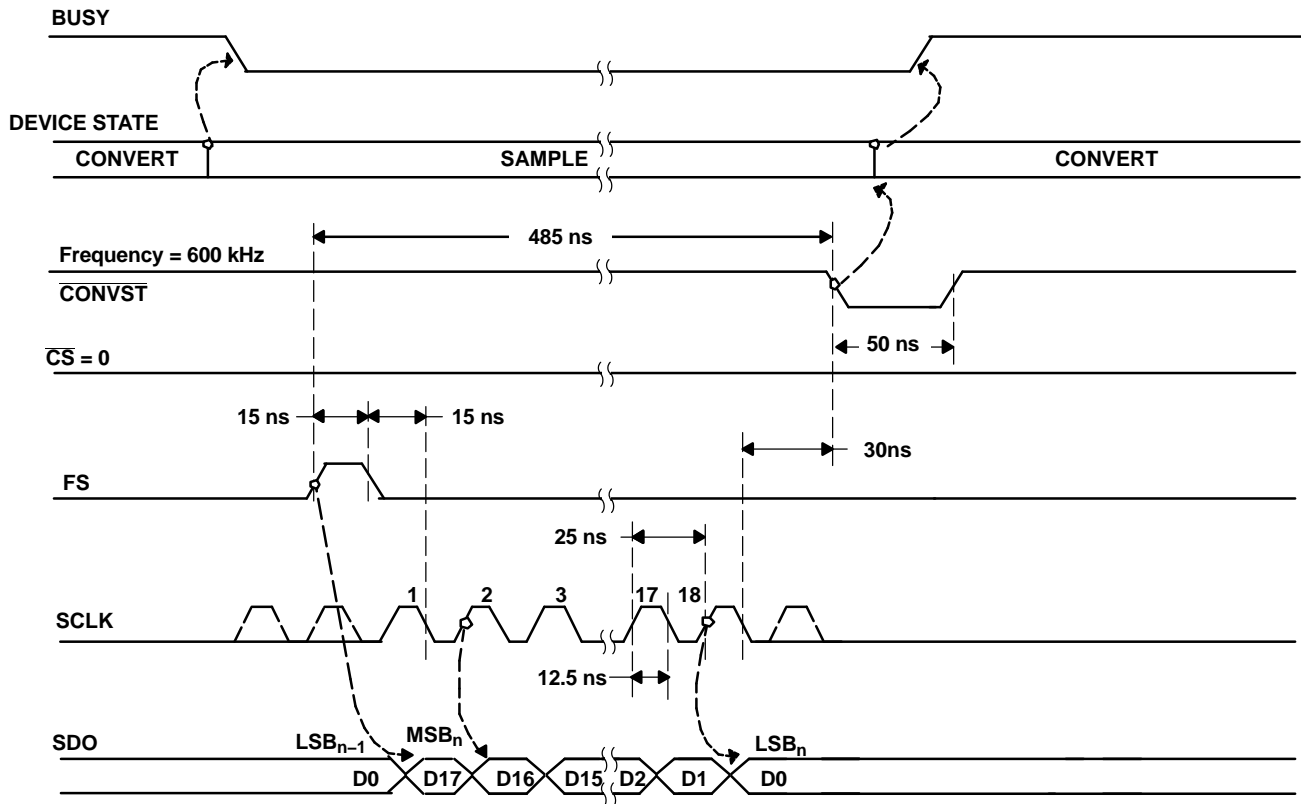

Figure 59. Example Stimulus in Serial Interface With FS Active, Back-To-Back Conversion that Achieves 600 KSPS

## PACKAGING INFORMATION

Orderable Device	Status (1)	Package Type	Package Drawing	Pins	Package Qty	Eco Plan (2)	Lead/Ball Finish (6)	MSL Peak Temp (3)	Op Temp (°C)	Device Marking (4/5)	Samples
ADS8382IBRHPT	ACTIVE	VQFN	RHP	28	250	Green (RoHS & no Sb/Br)	CU NIPDAU	Level-2-260C-1 YEAR	-40 to 85	ADS8382I B	<a href="#">Samples</a>
ADS8382IBRHPTG4	ACTIVE	VQFN	RHP	28	250	Green (RoHS & no Sb/Br)	CU NIPDAU	Level-2-260C-1 YEAR	-40 to 85	ADS8382I B	<a href="#">Samples</a>
ADS8382IRHPT	ACTIVE	VQFN	RHP	28	250	Green (RoHS & no Sb/Br)	CU NIPDAU	Level-2-260C-1 YEAR	-40 to 85	ADS8382I	<a href="#">Samples</a>

(1) The marketing status values are defined as follows:

**ACTIVE:** Product device recommended for new designs.

**LIFEBUY:** TI has announced that the device will be discontinued, and a lifetime-buy period is in effect.

**NRND:** Not recommended for new designs. Device is in production to support existing customers, but TI does not recommend using this part in a new design.

**PREVIEW:** Device has been announced but is not in production. Samples may or may not be available.

**OBsolete:** TI has discontinued the production of the device.

(2) Eco Plan - The planned eco-friendly classification: Pb-Free (RoHS), Pb-Free (RoHS Exempt), or Green (RoHS & no Sb/Br) - please check <http://www.ti.com/productcontent> for the latest availability information and additional product content details.

**TBD:** The Pb-Free/Green conversion plan has not been defined.

**Pb-Free (RoHS):** TI's terms "Lead-Free" or "Pb-Free" mean semiconductor products that are compatible with the current RoHS requirements for all 6 substances, including the requirement that lead not exceed 0.1% by weight in homogeneous materials. Where designed to be soldered at high temperatures, TI Pb-Free products are suitable for use in specified lead-free processes.

**Pb-Free (RoHS Exempt):** This component has a RoHS exemption for either 1) lead-based flip-chip solder bumps used between the die and package, or 2) lead-based die adhesive used between the die and leadframe. The component is otherwise considered Pb-Free (RoHS compatible) as defined above.

**Green (RoHS & no Sb/Br):** TI defines "Green" to mean Pb-Free (RoHS compatible), and free of Bromine (Br) and Antimony (Sb) based flame retardants (Br or Sb do not exceed 0.1% by weight in homogeneous material)

(3) MSL, Peak Temp. - The Moisture Sensitivity Level rating according to the JEDEC industry standard classifications, and peak solder temperature.

(4) There may be additional marking, which relates to the logo, the lot trace code information, or the environmental category on the device.

(5) Multiple Device Markings will be inside parentheses. Only one Device Marking contained in parentheses and separated by a "~" will appear on a device. If a line is indented then it is a continuation of the previous line and the two combined represent the entire Device Marking for that device.

(6) Lead/Ball Finish - Orderable Devices may have multiple material finish options. Finish options are separated by a vertical ruled line. Lead/Ball Finish values may wrap to two lines if the finish value exceeds the maximum column width.

**Important Information and Disclaimer:** The information provided on this page represents TI's knowledge and belief as of the date that it is provided. TI bases its knowledge and belief on information provided by third parties, and makes no representation or warranty as to the accuracy of such information. Efforts are underway to better integrate information from third parties. TI has taken and

continues to take reasonable steps to provide representative and accurate information but may not have conducted destructive testing or chemical analysis on incoming materials and chemicals. TI and TI suppliers consider certain information to be proprietary, and thus CAS numbers and other limited information may not be available for release.

In no event shall TI's liability arising out of such information exceed the total purchase price of the TI part(s) at issue in this document sold by TI to Customer on an annual basis.

## TAPE AND REEL INFORMATION



### QUADRANT ASSIGNMENTS FOR PIN 1 ORIENTATION IN TAPE



\*All dimensions are nominal

Device	Package Type	Package Drawing	Pins	SPQ	Reel Diameter (mm)	Reel Width W1 (mm)	A0 (mm)	B0 (mm)	K0 (mm)	P1 (mm)	W (mm)	Pin1 Quadrant
ADS8382IBRHPT	VQFN	RHP	28	250	180.0	16.4	6.3	6.3	1.5	12.0	16.0	Q2
ADS8382IRHPT	VQFN	RHP	28	250	180.0	16.4	6.3	6.3	1.5	12.0	16.0	Q2

**TAPE AND REEL BOX DIMENSIONS**

\*All dimensions are nominal

Device	Package Type	Package Drawing	Pins	SPQ	Length (mm)	Width (mm)	Height (mm)
ADS8382IBRHPT	VQFN	RHP	28	250	213.0	191.0	55.0
ADS8382IRHPT	VQFN	RHP	28	250	213.0	191.0	55.0



# MECHANICAL DATA

RHP (S-PVQFN-N28)

PLASTIC QUAD FLATPACK NO-LEAD

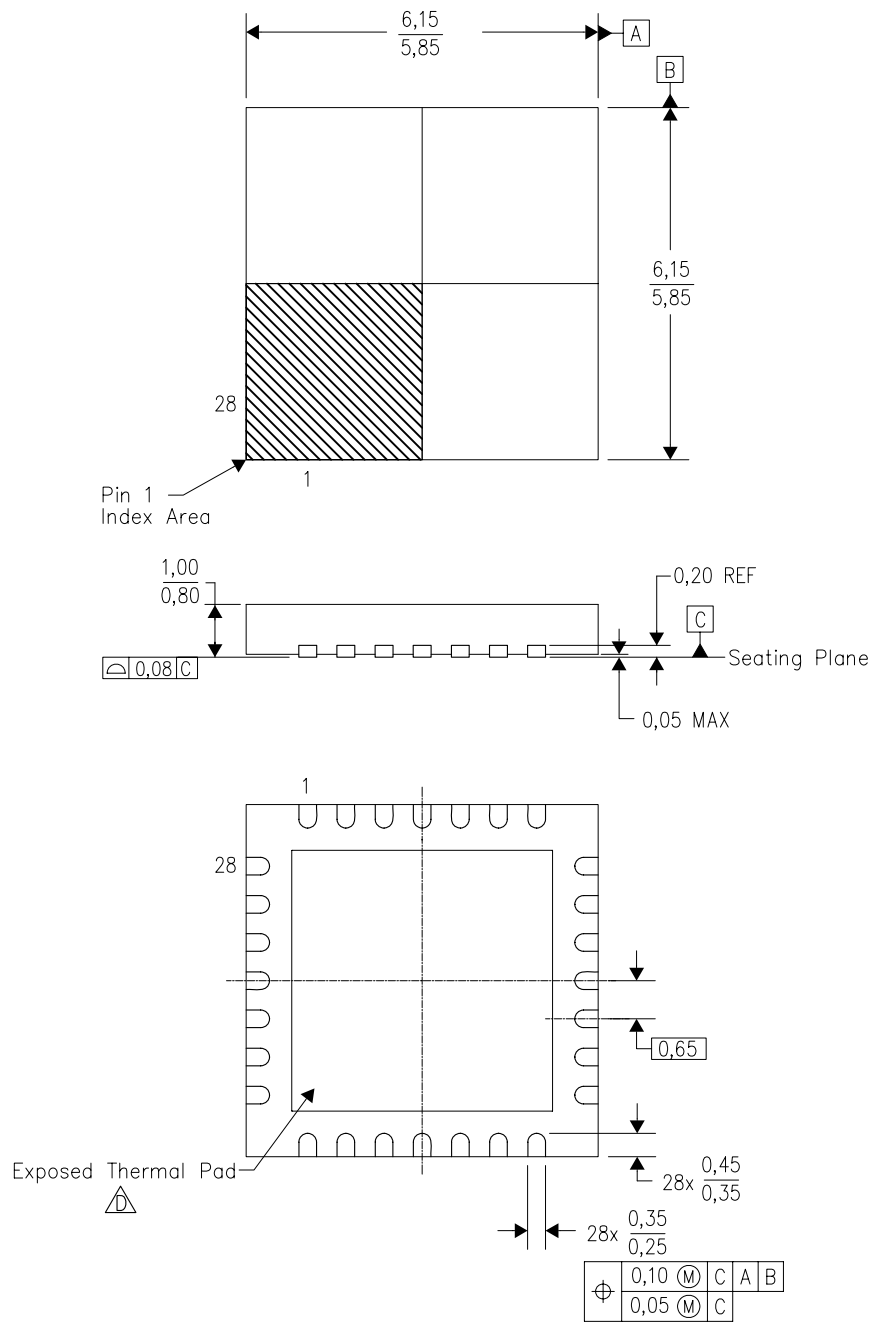

4205387/C 01/11

- NOTES:
- A. All linear dimensions are in millimeters. Dimensioning and tolerancing per ASME Y14.5M-1994.
  - B. This drawing is subject to change without notice.
  - C. QFN (Quad Flatpack No-Lead) Package configuration.
  -  The package thermal pad must be soldered to the board for thermal and mechanical performance. See the Product Data Sheet for details regarding the exposed thermal pad dimensions.

## THERMAL PAD MECHANICAL DATA

RHP (S-PVQFN-N28)

PLASTIC QUAD FLATPACK NO-LEAD

### THERMAL INFORMATION

This package incorporates an exposed thermal pad that is designed to be attached directly to an external heatsink. The thermal pad must be soldered directly to the printed circuit board (PCB). After soldering, the PCB can be used as a heatsink. In addition, through the use of thermal vias, the thermal pad can be attached directly to the appropriate copper plane shown in the electrical schematic for the device, or alternatively, can be attached to a special heatsink structure designed into the PCB. This design optimizes the heat transfer from the integrated circuit (IC).

For information on the Quad Flatpack No-Lead (QFN) package and its advantages, refer to Application Report, QFN/SON PCB Attachment, Texas Instruments Literature No. SLUA271. This document is available at [www.ti.com](http://www.ti.com).

The exposed thermal pad dimensions for this package are shown in the following illustration.

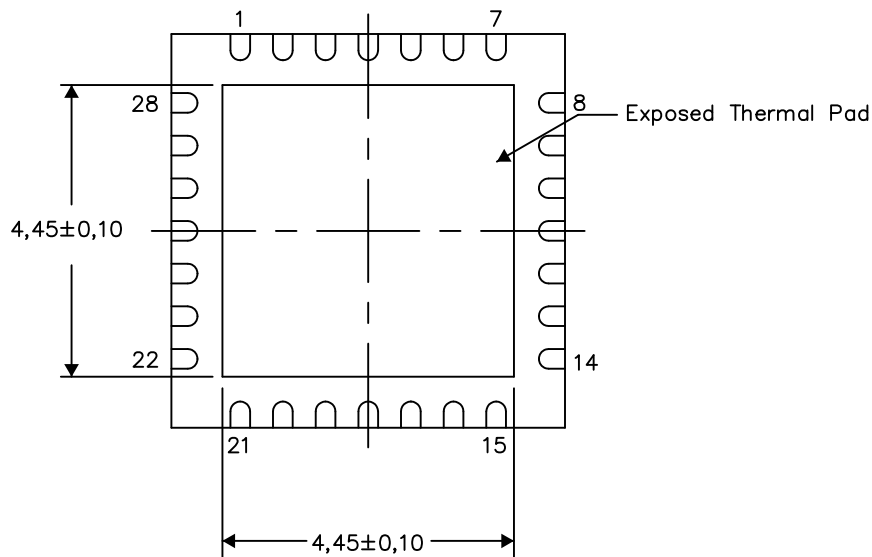

Bottom View

Exposed Thermal Pad Dimensions

4206484/F 06/12

NOTE: All linear dimensions are in millimeters

RHP (S-PVQFN-N28)

PLASTIC QUAD FLATPACK NO-LEAD

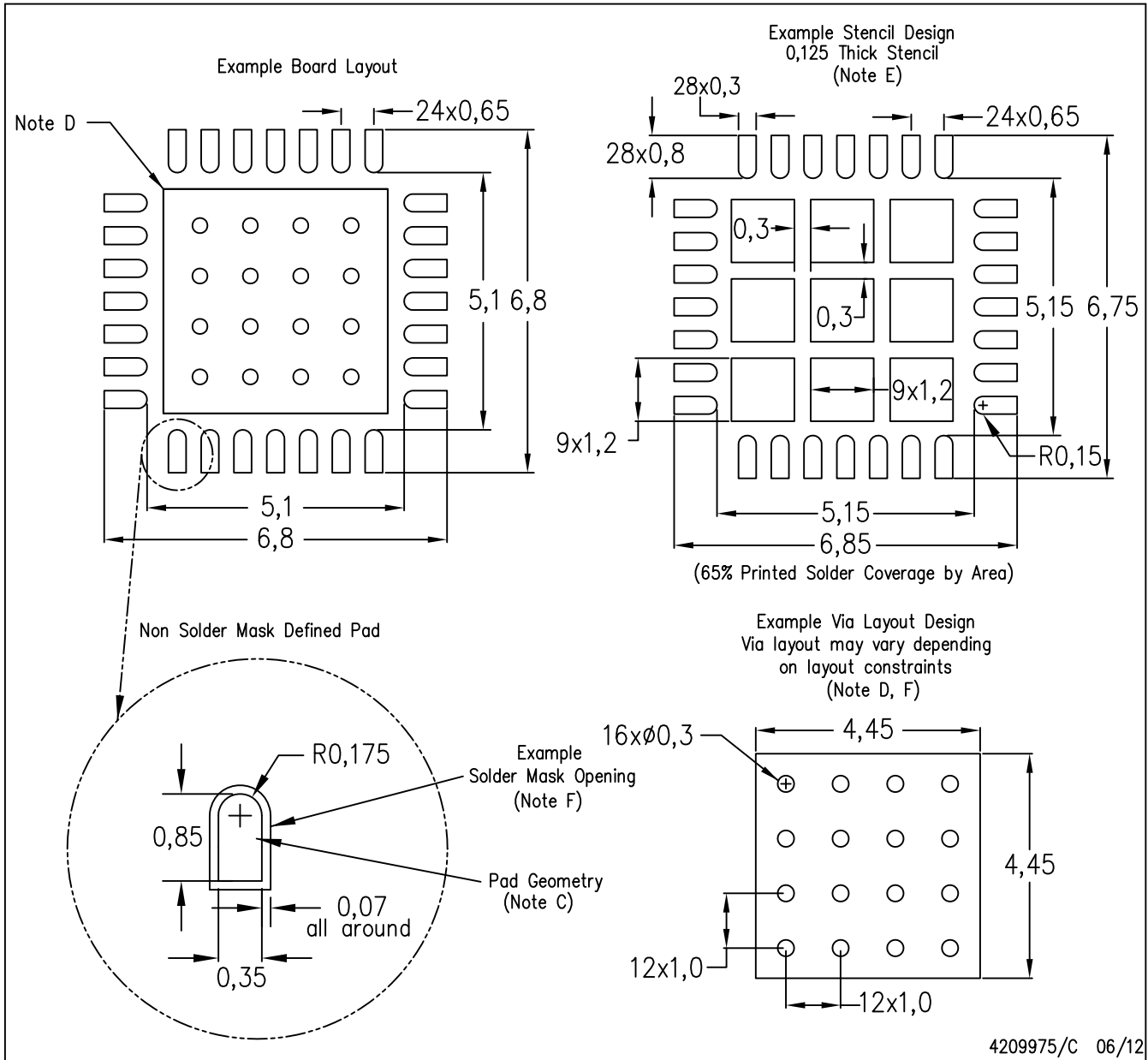

- NOTES:
- All linear dimensions are in millimeters.
  - This drawing is subject to change without notice.
  - Publication IPC-7351 is recommended for alternate designs.
  - This package is designed to be soldered to a thermal pad on the board. Refer to Application Note, Quad Flat-Pack Packages, Texas Instruments Literature No. SLUA271, and also the Product Data Sheets for specific thermal information, via requirements, and recommended board layout. These documents are available at [www.ti.com](http://www.ti.com) <<http://www.ti.com>>.
  - Laser cutting apertures with trapezoidal walls and also rounding corners will offer better paste release. Customers should contact their board assembly site for stencil design recommendations. Refer to IPC 7525 for stencil design considerations.
  - Customers should contact their board fabrication site for recommended solder mask tolerances and via tenting recommendations for vias placed in the thermal pad.

## IMPORTANT NOTICE

Texas Instruments Incorporated and its subsidiaries (TI) reserve the right to make corrections, enhancements, improvements and other changes to its semiconductor products and services per JESD46, latest issue, and to discontinue any product or service per JESD48, latest issue. Buyers should obtain the latest relevant information before placing orders and should verify that such information is current and complete. All semiconductor products (also referred to herein as "components") are sold subject to TI's terms and conditions of sale supplied at the time of order acknowledgment.

TI warrants performance of its components to the specifications applicable at the time of sale, in accordance with the warranty in TI's terms and conditions of sale of semiconductor products. Testing and other quality control techniques are used to the extent TI deems necessary to support this warranty. Except where mandated by applicable law, testing of all parameters of each component is not necessarily performed.

TI assumes no liability for applications assistance or the design of Buyers' products. Buyers are responsible for their products and applications using TI components. To minimize the risks associated with Buyers' products and applications, Buyers should provide adequate design and operating safeguards.

TI does not warrant or represent that any license, either express or implied, is granted under any patent right, copyright, mask work right, or other intellectual property right relating to any combination, machine, or process in which TI components or services are used. Information published by TI regarding third-party products or services does not constitute a license to use such products or services or a warranty or endorsement thereof. Use of such information may require a license from a third party under the patents or other intellectual property of the third party, or a license from TI under the patents or other intellectual property of TI.

Reproduction of significant portions of TI information in TI data books or data sheets is permissible only if reproduction is without alteration and is accompanied by all associated warranties, conditions, limitations, and notices. TI is not responsible or liable for such altered documentation. Information of third parties may be subject to additional restrictions.

Resale of TI components or services with statements different from or beyond the parameters stated by TI for that component or service voids all express and any implied warranties for the associated TI component or service and is an unfair and deceptive business practice. TI is not responsible or liable for any such statements.

Buyer acknowledges and agrees that it is solely responsible for compliance with all legal, regulatory and safety-related requirements concerning its products, and any use of TI components in its applications, notwithstanding any applications-related information or support that may be provided by TI. Buyer represents and agrees that it has all the necessary expertise to create and implement safeguards which anticipate dangerous consequences of failures, monitor failures and their consequences, lessen the likelihood of failures that might cause harm and take appropriate remedial actions. Buyer will fully indemnify TI and its representatives against any damages arising out of the use of any TI components in safety-critical applications.

In some cases, TI components may be promoted specifically to facilitate safety-related applications. With such components, TI's goal is to help enable customers to design and create their own end-product solutions that meet applicable functional safety standards and requirements. Nonetheless, such components are subject to these terms.

No TI components are authorized for use in FDA Class III (or similar life-critical medical equipment) unless authorized officers of the parties have executed a special agreement specifically governing such use.

Only those TI components which TI has specifically designated as military grade or "enhanced plastic" are designed and intended for use in military/aerospace applications or environments. Buyer acknowledges and agrees that any military or aerospace use of TI components which have **not** been so designated is solely at the Buyer's risk, and that Buyer is solely responsible for compliance with all legal and regulatory requirements in connection with such use.

TI has specifically designated certain components as meeting ISO/TS16949 requirements, mainly for automotive use. In any case of use of non-designated products, TI will not be responsible for any failure to meet ISO/TS16949.

### Products

Audio	<a href="http://www.ti.com/audio">www.ti.com/audio</a>
Amplifiers	<a href="http://amplifier.ti.com">amplifier.ti.com</a>
Data Converters	<a href="http://dataconverter.ti.com">dataconverter.ti.com</a>
DLP® Products	<a href="http://www.dlp.com">www.dlp.com</a>
DSP	<a href="http://dsp.ti.com">dsp.ti.com</a>
Clocks and Timers	<a href="http://www.ti.com/clocks">www.ti.com/clocks</a>
Interface	<a href="http://interface.ti.com">interface.ti.com</a>
Logic	<a href="http://logic.ti.com">logic.ti.com</a>
Power Mgmt	<a href="http://power.ti.com">power.ti.com</a>
Microcontrollers	<a href="http://microcontroller.ti.com">microcontroller.ti.com</a>
RFID	<a href="http://www.ti-rfid.com">www.ti-rfid.com</a>
OMAP Applications Processors	<a href="http://www.ti.com/omap">www.ti.com/omap</a>
Wireless Connectivity	<a href="http://www.ti.com/wirelessconnectivity">www.ti.com/wirelessconnectivity</a>

### Applications

Automotive and Transportation	<a href="http://www.ti.com/automotive">www.ti.com/automotive</a>
Communications and Telecom	<a href="http://www.ti.com/communications">www.ti.com/communications</a>
Computers and Peripherals	<a href="http://www.ti.com/computers">www.ti.com/computers</a>
Consumer Electronics	<a href="http://www.ti.com/consumer-apps">www.ti.com/consumer-apps</a>
Energy and Lighting	<a href="http://www.ti.com/energy">www.ti.com/energy</a>
Industrial	<a href="http://www.ti.com/industrial">www.ti.com/industrial</a>
Medical	<a href="http://www.ti.com/medical">www.ti.com/medical</a>
Security	<a href="http://www.ti.com/security">www.ti.com/security</a>
Space, Avionics and Defense	<a href="http://www.ti.com/space-avionics-defense">www.ti.com/space-avionics-defense</a>
Video and Imaging	<a href="http://www.ti.com/video">www.ti.com/video</a>

### TI E2E Community

[e2e.ti.com](http://e2e.ti.com)