

CMOS HEX VOLTAGE-LEVEL SHIFTER FOR TTL-TO-CMOS or CMOS-TO-CMOS OPERATION

FEATURES

- Independence of Power-Supply Sequence Considerations – V_{CC} Can Exceed V_{DD} ; Input Signals Can Exceed Both V_{CC} and V_{DD}
- Up and Down Level-Shifting Capability
- Shiftable Input Threshold for Either CMOS or TTL Compatibility
- Standardized Symmetrical Output Characteristics
- 100% Tested for Quiescent Current at 20 V
- Maximum Input Current of 1 μ A at 18 V Over Full Package-Temperature Range: 100 nA at 18 V and 25°C
- 5 V, 10 V, and 15 V Parametric Ratings
- Meets All Requirements of JEDEC Standard No. 13B, "Standard Specifications for Description of 'B' Series CMOS Devices"

SUPPORTS DEFENSE, AEROSPACE, AND MEDICAL APPLICATIONS

- Controlled Baseline
- One Assembly/Test Site
- One Fabrication Site
- Available in Military (–55°C/125°C) Temperature Range⁽¹⁾
- Extended Product Life Cycle
- Extended Product-Change Notification
- Product Traceability

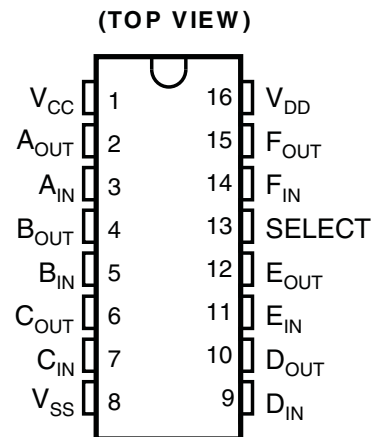

(1) Additional temperature ranges are available – contact factory

DESCRIPTION

CD4504B hex voltage level-shifter consists of six circuits which shift input signals from the V_{CC} logic level to the V_{DD} logic level. To shift TTL signals to CMOS logic levels, the SELECT input is at the V_{CC} HIGH logic state. When the SELECT input is at a LOW logic state, each circuit translates signals from one CMOS level to another.

ORDERING INFORMATION⁽¹⁾

T_A	PACKAGE ⁽²⁾		ORDERABLE PART NUMBER	TOP-SIDE MARKING
–55°C to 125°C	TSSOP – PW	Reel of 2000	CD4504BMPWREP	4504BEP

(1) Package drawings, thermal data, and symbolization are available at www.ti.com/packaging.

(2) For the most current package and ordering information, see the Package Option Addendum at the end of this document, or see the TI website at www.ti.com.



Please be aware that an important notice concerning availability, standard warranty, and use in critical applications of Texas Instruments semiconductor products and disclaimers thereto appears at the end of this data sheet.

FUNCTIONAL BLOCK DIAGRAM

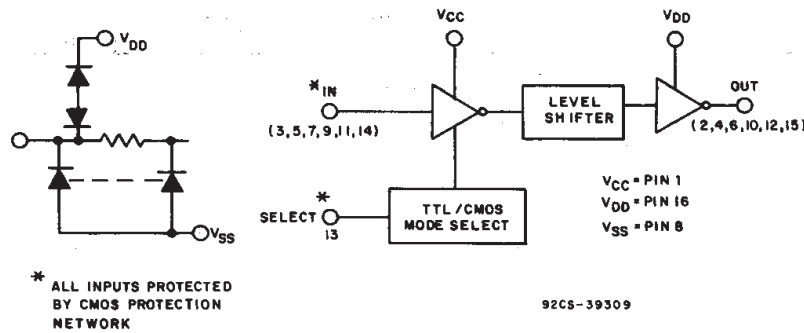

ABSOLUTE MAXIMUM RATINGS

over operating free-air temperature range (unless otherwise noted)

		MIN	MAX	UNIT	
V_{DD}	DC supply-voltage range, voltages referenced to V_{SS} terminal	-0.5	+20	V	
	Input voltage range, all inputs	-0.5	$V_{CC} + 0.5$	V	
	DC input current, any one input		± 10	mA	
P_D	Power dissipation per package	$T_A = -55^\circ\text{C to } +100^\circ\text{C}$		500	mW
		$T_A = +100^\circ\text{C to } +125^\circ\text{C}$		Derate Linearly at 12 mW/°C to 200 nW	
	Device dissipation per output transistor, for $T_A =$ full package-temperature range (all package types)		100	mW	
T_A	Operating temperature range	-55	+125	°C	
θ_{JA}	Package thermal impedance ⁽¹⁾		91.1	°C/W	
T_{stg}	Storage temperature range	-85	+150	°C	
	Lead temperature (during soldering), at distance $1/16 \pm 1/32$ inch (1.59 ± 0.79 mm) from case for 10 s max		+265	°C	

(1) The package thermal impedance is calculated in accordance with JESD 51-7.

STATIC ELECTRICAL CHARACTERISTICS

over operating free-air temperature range (unless otherwise noted)

CHARACTERISTIC	CONDITIONS				LIMITS AT INDICATED TEMPERATURES (°C)							UNIT	
	V _O (V)	V _{IN} (V)	V _{CC} (V)	V _{CC} (V)	-55	-40	+85	+125	+25				
									MIN	TYP	MAX		
Quiescent device current, I _{DD} max and I _{CC} in CMOS-CMOS mode		0, 5	5	5	1.5	1.5	1.5	1.5		0.02	1.5	mA	
		0, 10	5	10	2	2	2	2		0.02	2		
		0, 15	5	15	4	4	120	120		0.02	4	μA	
		0, 20	5	20	20	20	600	600		0.04	20		
Quiescent device current, I _{CC} max TTL-CMOS mode		0, 5	5	5	5	5	6	6		2.5	5	mA	
		0, 10	5	10	5	5	6	6		2.5	5		
		0, 15	5	15	5	5	6	6		2.5	5		
Output low (sink) current, I _{OL} min	0.4	0, 5		5	0.64	0.61	0.42	0.36	0.51	1		mA	
	0.5	0, 10		10	1.6	1.5	1.1	0.9	1.3	2.6			
	1.5	0, 15		15	4.2	4	2.8	2.4	3.4	6.8			
Output high (source) current, I _{OH} min	4.6	0, 5		5	-0.64	-0.61	-0.42	-0.36	-0.51	-1		mA	
	2.5	0, 5		5	-2	-1.8	-1.3	-1.15	-1.6	-3.2			
	9.5	0, 10		10	-1.6	-1.5	-1.1	-0.9	-1.3	-2.6			
	13.5	0, 15		15	-4.2	-4	-2.8	-2.4	-3.4	-6.8			
Output voltage: low-level, V _{OL} max		0, 5		5	0.05					0	0.05	V	
		0, 10		10	0.05					0	0.05		
		0, 15		15	0.05					0	0.05		
Output voltage: high-level, V _{OH} min		0, 5		5	4.95				4.95	5		V	
		0, 10		10	9.95				9.95	10			
		0, 15		15	14.95				14.95	15			
Input low voltage, V _{IL} max ⁽¹⁾	TTL-CMOS	1		5	10	0.8						0.8	V
	TTL-CMOS	1		5	15	0.8						0.8	
	CMOS-CMOS	1		5	10	1.5						1.5	
	CMOS-CMOS	1.5		5	15	1.5						1.5	
	CMOS-CMOS	1.5		10	15	3						3	
Input high voltage, V _{IH} min ⁽¹⁾	TTL-CMOS	9		5	10	2				2			V
	TTL-CMOS	13.5		5	15	2				2			
	CMOS-CMOS	9		5	10	3.5				3.5			
	CMOS-CMOS	13.5		5	15	3.5				3.5			
	CMOS-CMOS	13.5		10	15	7				7			
Input current, I _{IN} max		0, 18		18	±0.1	±0.1	±1	±1		±10 ⁻⁵	±0.1	μA	

(1) Applies to the six input signals. For mode control (P13), only the CMOS-CMOS ratings apply.

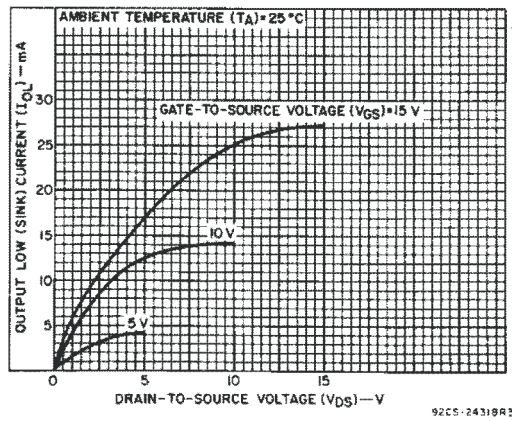

Figure 1. Typical Output Low (sink) Current Characteristics

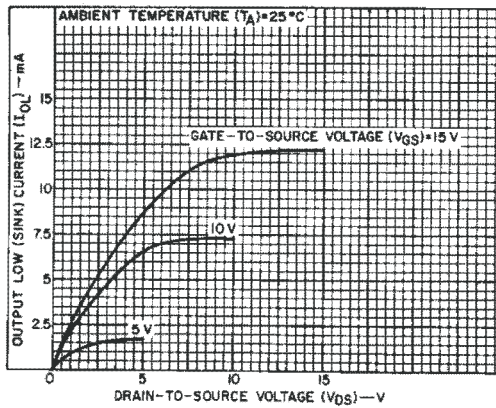

Figure 2. Minimum Output Low (sink) Current Characteristics

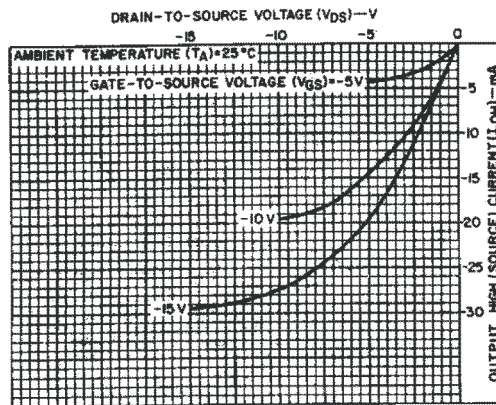

Figure 3. Typical Output High (source) Current Characteristics

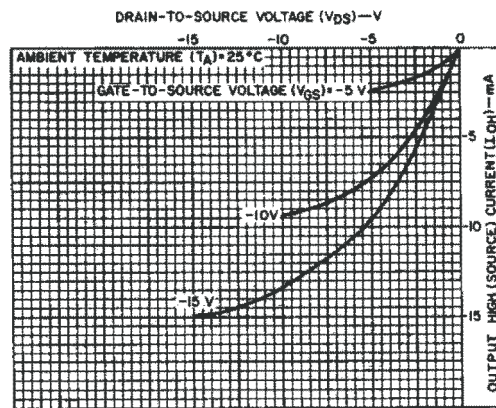

Figure 4. Minimum Output High (source) Current Characteristics

RECOMMENDED OPERATING CONDITIONS

For maximum reliability, nominal operating conditions should be selected so that operation is always within the following ranges:

CHARACTERISTIC		MIN	MAX	UNIT
V_{DD}	Supply-voltage range (for T_A = full package temperature range)	5	18	V

DYNAMIC ELECTRICAL CHARACTERISTICS

$T_A = 25^\circ\text{C}$, Input $t_r, t_f = 20 \text{ ns}$, $C_L = 50 \text{ pF}$, $R_L = 200 \Omega$

CHARACTERISTIC	SHIFTING MODE	V_{CC} (V)	V_{DD} (V)	LIMITS		UNIT		
				TYP	MAX			
t_{PHL} Propagation delay: high-to-low,	TTL to CMOS $V_{DD} > V_{CC}$	5	10	140	280	ns		
		5	15	140	280			
	CMOS to CMOS $V_{DD} > V_{CC}$	5	10	120	240			
		5	15	120	240			
	CMOS to CMOS $V_{CC} > V_{DD}$	10	15	70	140			
		10	5	275	550			
		15	5	275	550			
	t_{PLH} Propagation delay: low-to-high	TTL to CMOS $V_{DD} > V_{CC}$	5	10	140		280	ns
			5	15	140		280	
CMOS to CMOS $V_{DD} > V_{CC}$		5	10	120	240			
		5	15	120	240			
CMOS to CMOS $V_{CC} > V_{DD}$		10	15	70	140			
		10	5	200	400			
		15	5	200	400			
t_{THL}, t_{TLH} Transition time		All modes		5	100	200	ns	
				10	50	100		
	15			40	80			
C_{IN}	Input capacitance	Any input		5	7.5	pF		

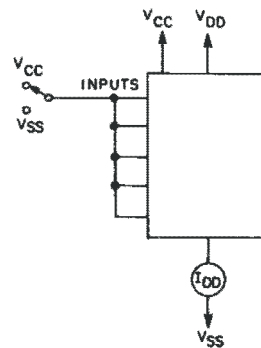

Figure 5. Quiescent Device Current

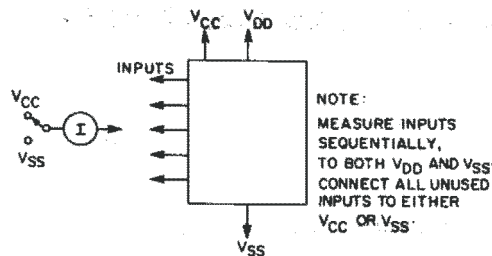

Figure 6. Input Current

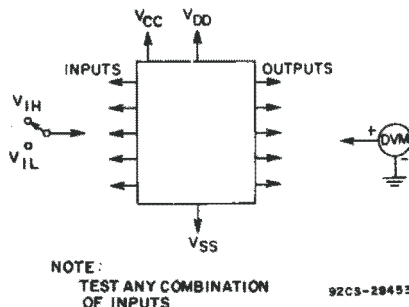

Figure 7. Input Voltage

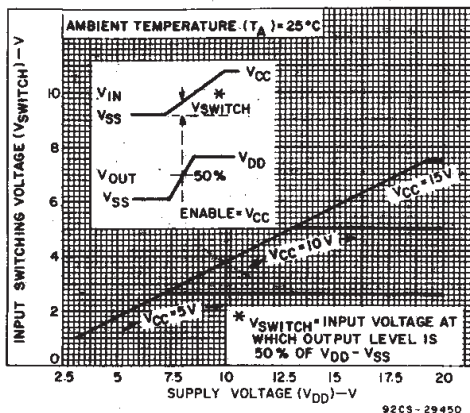

Figure 8. Typical Input Switching as a Function of High-Level Supply Voltage (SELECT at V_{CC} – CMOS Mode)

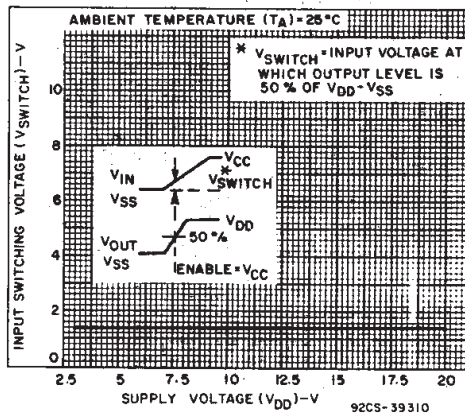

Figure 9. Typical Input Switching as a Function of High-Level Supply Voltage (SELECT at V_{SS} – TTL Mode)

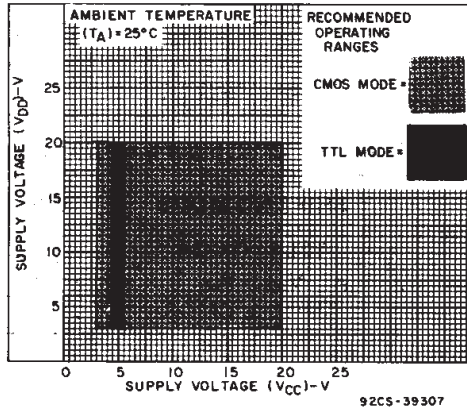
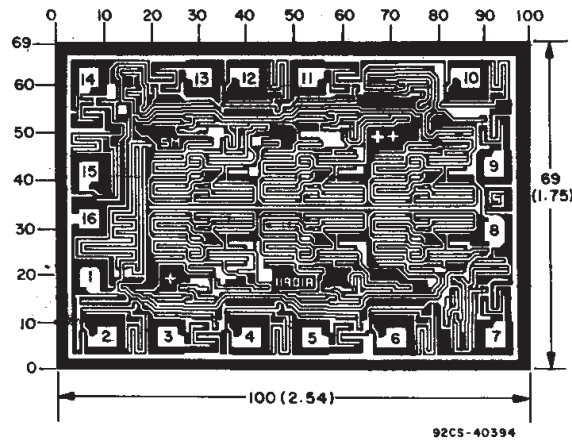

Figure 10. High-Level Supply Voltage vs. Low-Level Supply Voltage



- A. Dimensions in parentheses are in millimeters and are derived from the basic inch dimensions as indicated. Grid graduations are in mils (10^{-3} inch).

Figure 11. Dimensions and Pad Layout

PACKAGING INFORMATION

Orderable Device	Status (1)	Package Type	Package Drawing	Pins	Package Qty	Eco Plan (2)	Lead/Ball Finish (6)	MSL Peak Temp (3)	Op Temp (°C)	Device Marking (4/5)	Samples
CD4504BMPWREP	ACTIVE	TSSOP	PW	16	2000	Green (RoHS & no Sb/Br)	CU NIPDAU	Level-1-260C-UNLIM	-55 to 125	4504BEP	Samples
V62/09606-01XE	ACTIVE	TSSOP	PW	16	2000	Green (RoHS & no Sb/Br)	CU NIPDAU	Level-1-260C-UNLIM	-55 to 125	4504BEP	Samples

(1) The marketing status values are defined as follows:

ACTIVE: Product device recommended for new designs.

LIFEBUY: TI has announced that the device will be discontinued, and a lifetime-buy period is in effect.

NRND: Not recommended for new designs. Device is in production to support existing customers, but TI does not recommend using this part in a new design.

PREVIEW: Device has been announced but is not in production. Samples may or may not be available.

OBSOLETE: TI has discontinued the production of the device.

(2) Eco Plan - The planned eco-friendly classification: Pb-Free (RoHS), Pb-Free (RoHS Exempt), or Green (RoHS & no Sb/Br) - please check <http://www.ti.com/productcontent> for the latest availability information and additional product content details.

TBD: The Pb-Free/Green conversion plan has not been defined.

Pb-Free (RoHS): TI's terms "Lead-Free" or "Pb-Free" mean semiconductor products that are compatible with the current RoHS requirements for all 6 substances, including the requirement that lead not exceed 0.1% by weight in homogeneous materials. Where designed to be soldered at high temperatures, TI Pb-Free products are suitable for use in specified lead-free processes.

Pb-Free (RoHS Exempt): This component has a RoHS exemption for either 1) lead-based flip-chip solder bumps used between the die and package, or 2) lead-based die adhesive used between the die and leadframe. The component is otherwise considered Pb-Free (RoHS compatible) as defined above.

Green (RoHS & no Sb/Br): TI defines "Green" to mean Pb-Free (RoHS compatible), and free of Bromine (Br) and Antimony (Sb) based flame retardants (Br or Sb do not exceed 0.1% by weight in homogeneous material)

(3) MSL, Peak Temp. - The Moisture Sensitivity Level rating according to the JEDEC industry standard classifications, and peak solder temperature.

(4) There may be additional marking, which relates to the logo, the lot trace code information, or the environmental category on the device.

(5) Multiple Device Markings will be inside parentheses. Only one Device Marking contained in parentheses and separated by a "~" will appear on a device. If a line is indented then it is a continuation of the previous line and the two combined represent the entire Device Marking for that device.

(6) Lead/Ball Finish - Orderable Devices may have multiple material finish options. Finish options are separated by a vertical ruled line. Lead/Ball Finish values may wrap to two lines if the finish value exceeds the maximum column width.

Important Information and Disclaimer: The information provided on this page represents TI's knowledge and belief as of the date that it is provided. TI bases its knowledge and belief on information provided by third parties, and makes no representation or warranty as to the accuracy of such information. Efforts are underway to better integrate information from third parties. TI has taken and continues to take reasonable steps to provide representative and accurate information but may not have conducted destructive testing or chemical analysis on incoming materials and chemicals. TI and TI suppliers consider certain information to be proprietary, and thus CAS numbers and other limited information may not be available for release.

In no event shall TI's liability arising out of such information exceed the total purchase price of the TI part(s) at issue in this document sold by TI to Customer on an annual basis.

OTHER QUALIFIED VERSIONS OF CD4504B-EP :

- Catalog: [CD4504B](#)
- Military: [CD4504B-MIL](#)

NOTE: Qualified Version Definitions:

- Catalog - TI's standard catalog product
- Military - QML certified for Military and Defense Applications

TAPE AND REEL INFORMATION



QUADRANT ASSIGNMENTS FOR PIN 1 ORIENTATION IN TAPE



*All dimensions are nominal

Device	Package Type	Package Drawing	Pins	SPQ	Reel Diameter (mm)	Reel Width W1 (mm)	A0 (mm)	B0 (mm)	K0 (mm)	P1 (mm)	W (mm)	Pin1 Quadrant
CD4504BMPWREP	TSSOP	PW	16	2000	330.0	12.4	6.9	5.6	1.6	8.0	12.0	Q1

TAPE AND REEL BOX DIMENSIONS



*All dimensions are nominal

Device	Package Type	Package Drawing	Pins	SPQ	Length (mm)	Width (mm)	Height (mm)
CD4504BMPWREP	TSSOP	PW	16	2000	367.0	367.0	35.0

PW (R-PDSO-G16)

PLASTIC SMALL OUTLINE



4040064-4/G 02/11

- NOTES:
- A. All linear dimensions are in millimeters. Dimensioning and tolerancing per ASME Y14.5M-1994.
 - B. This drawing is subject to change without notice.
 - C. Body length does not include mold flash, protrusions, or gate burrs. Mold flash, protrusions, or gate burrs shall not exceed 0,15 each side.
 - D. Body width does not include interlead flash. Interlead flash shall not exceed 0,25 each side.
 - E. Falls within JEDEC MO-153

PW (R-PDSO-G16)

PLASTIC SMALL OUTLINE

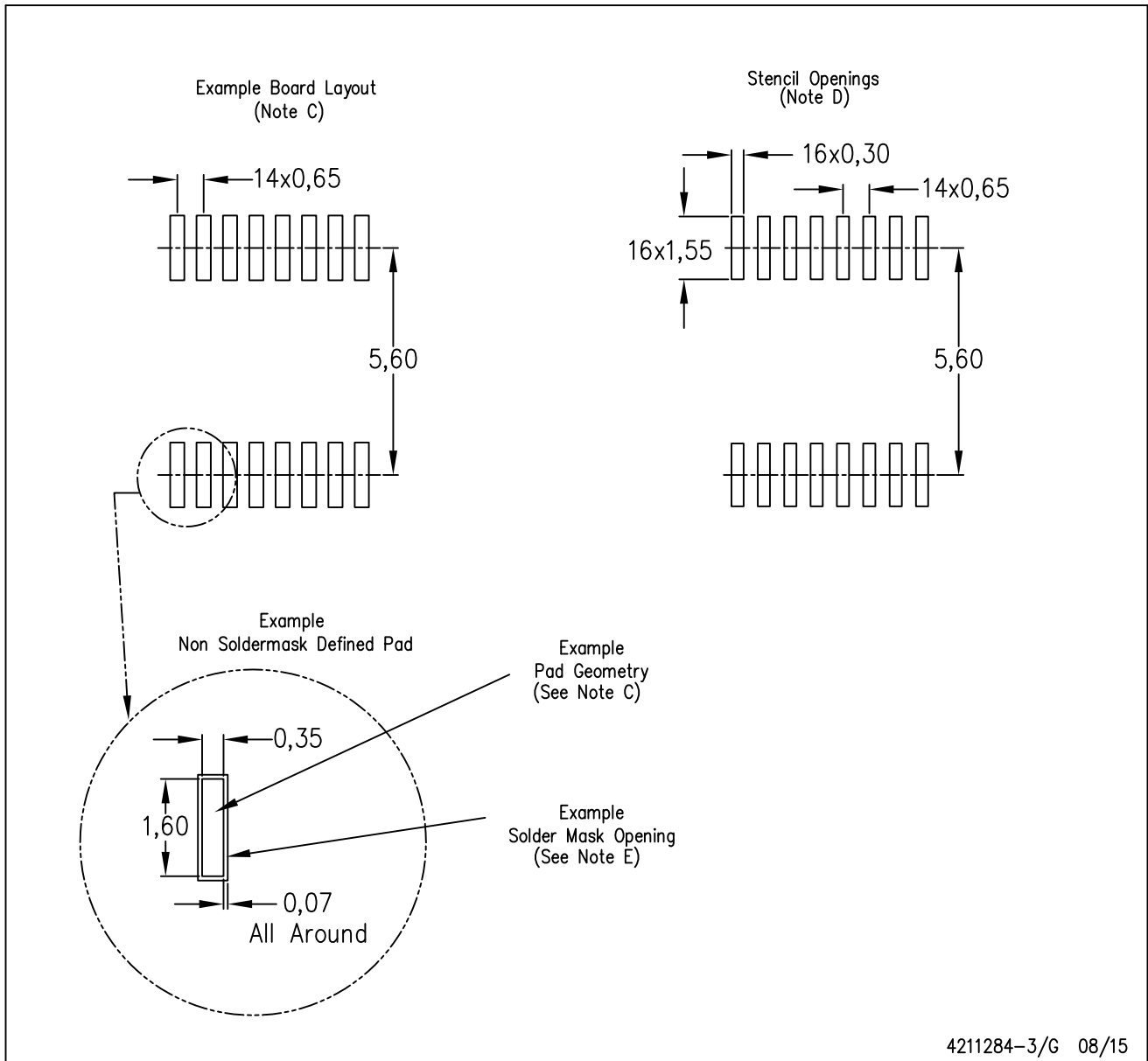

- NOTES:
- All linear dimensions are in millimeters.
 - This drawing is subject to change without notice.
 - Publication IPC-7351 is recommended for alternate designs.
 - Laser cutting apertures with trapezoidal walls and also rounding corners will offer better paste release. Customers should contact their board assembly site for stencil design recommendations. Refer to IPC-7525 for other stencil recommendations.
 - Customers should contact their board fabrication site for solder mask tolerances between and around signal pads.

IMPORTANT NOTICE

Texas Instruments Incorporated and its subsidiaries (TI) reserve the right to make corrections, enhancements, improvements and other changes to its semiconductor products and services per JESD46, latest issue, and to discontinue any product or service per JESD48, latest issue. Buyers should obtain the latest relevant information before placing orders and should verify that such information is current and complete. All semiconductor products (also referred to herein as "components") are sold subject to TI's terms and conditions of sale supplied at the time of order acknowledgment.

TI warrants performance of its components to the specifications applicable at the time of sale, in accordance with the warranty in TI's terms and conditions of sale of semiconductor products. Testing and other quality control techniques are used to the extent TI deems necessary to support this warranty. Except where mandated by applicable law, testing of all parameters of each component is not necessarily performed.

TI assumes no liability for applications assistance or the design of Buyers' products. Buyers are responsible for their products and applications using TI components. To minimize the risks associated with Buyers' products and applications, Buyers should provide adequate design and operating safeguards.

TI does not warrant or represent that any license, either express or implied, is granted under any patent right, copyright, mask work right, or other intellectual property right relating to any combination, machine, or process in which TI components or services are used. Information published by TI regarding third-party products or services does not constitute a license to use such products or services or a warranty or endorsement thereof. Use of such information may require a license from a third party under the patents or other intellectual property of the third party, or a license from TI under the patents or other intellectual property of TI.

Reproduction of significant portions of TI information in TI data books or data sheets is permissible only if reproduction is without alteration and is accompanied by all associated warranties, conditions, limitations, and notices. TI is not responsible or liable for such altered documentation. Information of third parties may be subject to additional restrictions.

Resale of TI components or services with statements different from or beyond the parameters stated by TI for that component or service voids all express and any implied warranties for the associated TI component or service and is an unfair and deceptive business practice. TI is not responsible or liable for any such statements.

Buyer acknowledges and agrees that it is solely responsible for compliance with all legal, regulatory and safety-related requirements concerning its products, and any use of TI components in its applications, notwithstanding any applications-related information or support that may be provided by TI. Buyer represents and agrees that it has all the necessary expertise to create and implement safeguards which anticipate dangerous consequences of failures, monitor failures and their consequences, lessen the likelihood of failures that might cause harm and take appropriate remedial actions. Buyer will fully indemnify TI and its representatives against any damages arising out of the use of any TI components in safety-critical applications.

In some cases, TI components may be promoted specifically to facilitate safety-related applications. With such components, TI's goal is to help enable customers to design and create their own end-product solutions that meet applicable functional safety standards and requirements. Nonetheless, such components are subject to these terms.

No TI components are authorized for use in FDA Class III (or similar life-critical medical equipment) unless authorized officers of the parties have executed a special agreement specifically governing such use.

Only those TI components which TI has specifically designated as military grade or "enhanced plastic" are designed and intended for use in military/aerospace applications or environments. Buyer acknowledges and agrees that any military or aerospace use of TI components which have **not** been so designated is solely at the Buyer's risk, and that Buyer is solely responsible for compliance with all legal and regulatory requirements in connection with such use.

TI has specifically designated certain components as meeting ISO/TS16949 requirements, mainly for automotive use. In any case of use of non-designated products, TI will not be responsible for any failure to meet ISO/TS16949.

Products

Audio	www.ti.com/audio
Amplifiers	amplifier.ti.com
Data Converters	dataconverter.ti.com
DLP® Products	www.dlp.com
DSP	dsp.ti.com
Clocks and Timers	www.ti.com/clocks
Interface	interface.ti.com
Logic	logic.ti.com
Power Mgmt	power.ti.com
Microcontrollers	microcontroller.ti.com
RFID	www.ti-rfid.com
OMAP Applications Processors	www.ti.com/omap
Wireless Connectivity	www.ti.com/wirelessconnectivity

Applications

Automotive and Transportation	www.ti.com/automotive
Communications and Telecom	www.ti.com/communications
Computers and Peripherals	www.ti.com/computers
Consumer Electronics	www.ti.com/consumer-apps
Energy and Lighting	www.ti.com/energy
Industrial	www.ti.com/industrial
Medical	www.ti.com/medical
Security	www.ti.com/security
Space, Avionics and Defense	www.ti.com/space-avionics-defense
Video and Imaging	www.ti.com/video

TI E2E Community

e2e.ti.com