

## LM49321 Boomer® Audio Power Amplifier Series Audio Sub-System with Stereo DAC, Mono Class AB Loudspeaker Amplifier, OCL/SE Stereo Headphone Output and RF Suppression

Check for Samples: [LM49321](#), [LM49321RLEVEL](#)

### FEATURES

- 8-Bit Stereo DAC with up to 192kHz Sampling Rate
- Multiple Distinct Output Modes
- Mono Class AB Speaker Amplifier
- Stereo OCL/SE Headphone Amplifier
- Mono Earpiece Amplifier
- Differential Mono Analog Input
- Single-Ended Analog Inputs
- Independent Loudspeaker, Headphone and Mono Earpiece Volume controls
- I<sup>2</sup>C/SPI (Selectable) Compatible Interface
- Ultra Low Shutdown Current
- Click and Pop Suppression Circuit

### APPLICATIONS

- Cell Phones
- PDAs
- Laptop Computers
- Portable Devices

### KEY SPECIFICATIONS

- P<sub>OUT</sub> LS, 8Ω, 3.3V, 1% THD+N: 520 mW (Typ)
- P<sub>OUT</sub> HP, 32Ω, 3.3V, 1% THD+N: 36 mW (Typ)
- P<sub>OUT</sub> Mono Earpiece, 32Ω, 1% THD+N: 55 mW (Typ)
- Shutdown Current: 0.6 μA (Typ)
- SNR (DAC + Amplifier): 85 dB (Typ)

### DESCRIPTION

The LM49321 is an integrated audio sub-system designed for mono voice, stereo music cell phones connecting to base band processors with mono differential analog voice paths. Operating on a 3.3V supply, it combines a mono speaker amplifier delivering 520mW into an 8Ω load, a stereo headphone amplifier delivering 36mW per channel into a 32Ω load, and a mono earpiece amplifier delivering 55mW into a 32Ω load. The headphone amplifier can be configured for output capacitor-less (OCL) or single-ended (SE) mode. It integrates the audio amplifiers, volume control, mixer, and power management control all into a single package. In addition, the LM49321 routes and mixes the single-ended stereo and differential mono inputs into multiple distinct output modes. The LM49321 features an I<sup>2</sup>S serial interface for full range audio and an I<sup>2</sup>C or SPI compatible interface for control. The full range music path features an SNR of 85dB with up to 192kHz playback.

Boomer audio power amplifiers are designed specifically to provide high quality output power with a minimal amount of external components.



Please be aware that an important notice concerning availability, standard warranty, and use in critical applications of Texas Instruments semiconductor products and disclaimers thereto appears at the end of this data sheet.

All trademarks are the property of their respective owners.

Block Diagram

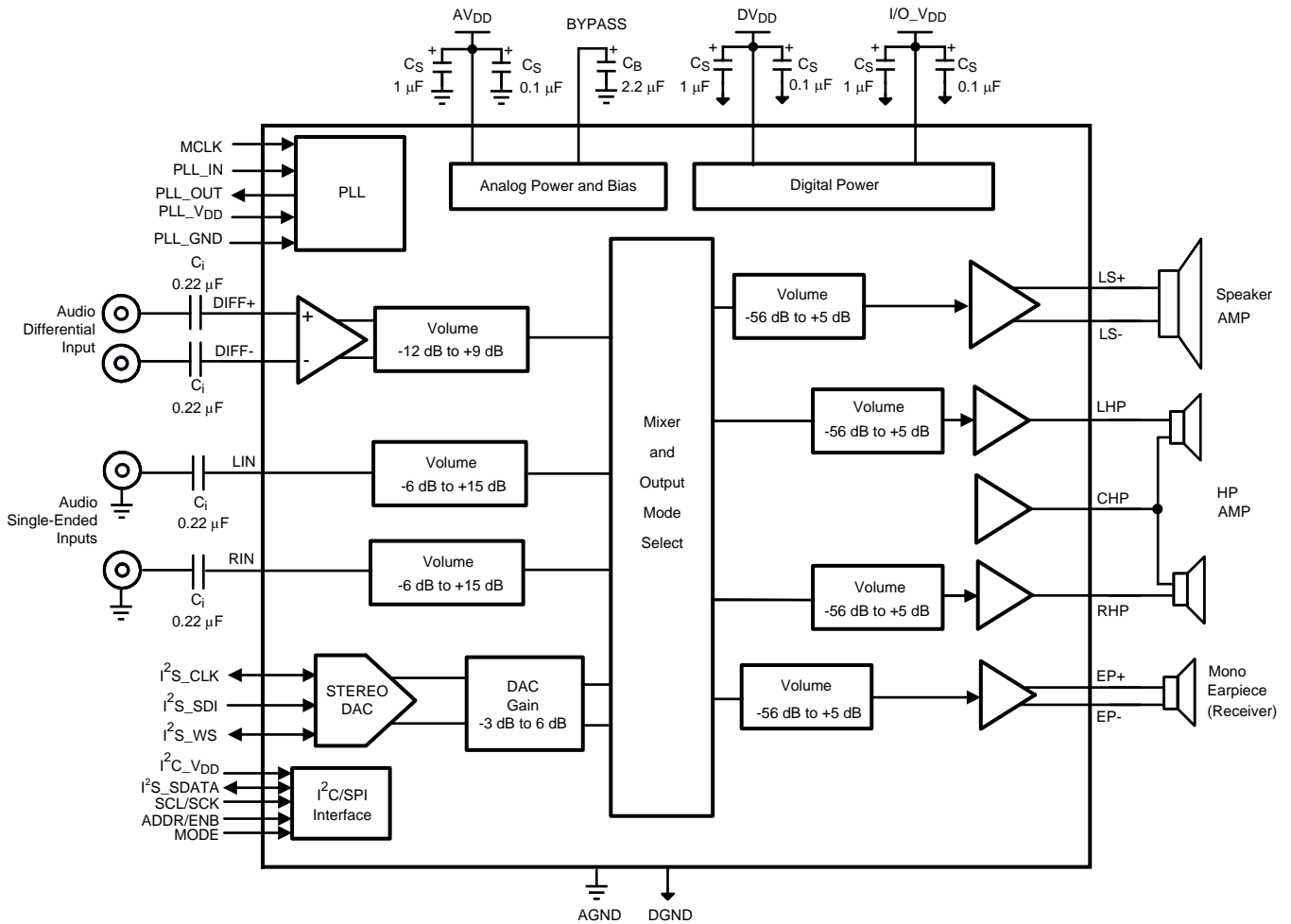


Figure 1. Typical Audio Amplifier Subsystem Application Circuit with Output Capacitor-Less (OCL) Headphone Configuration

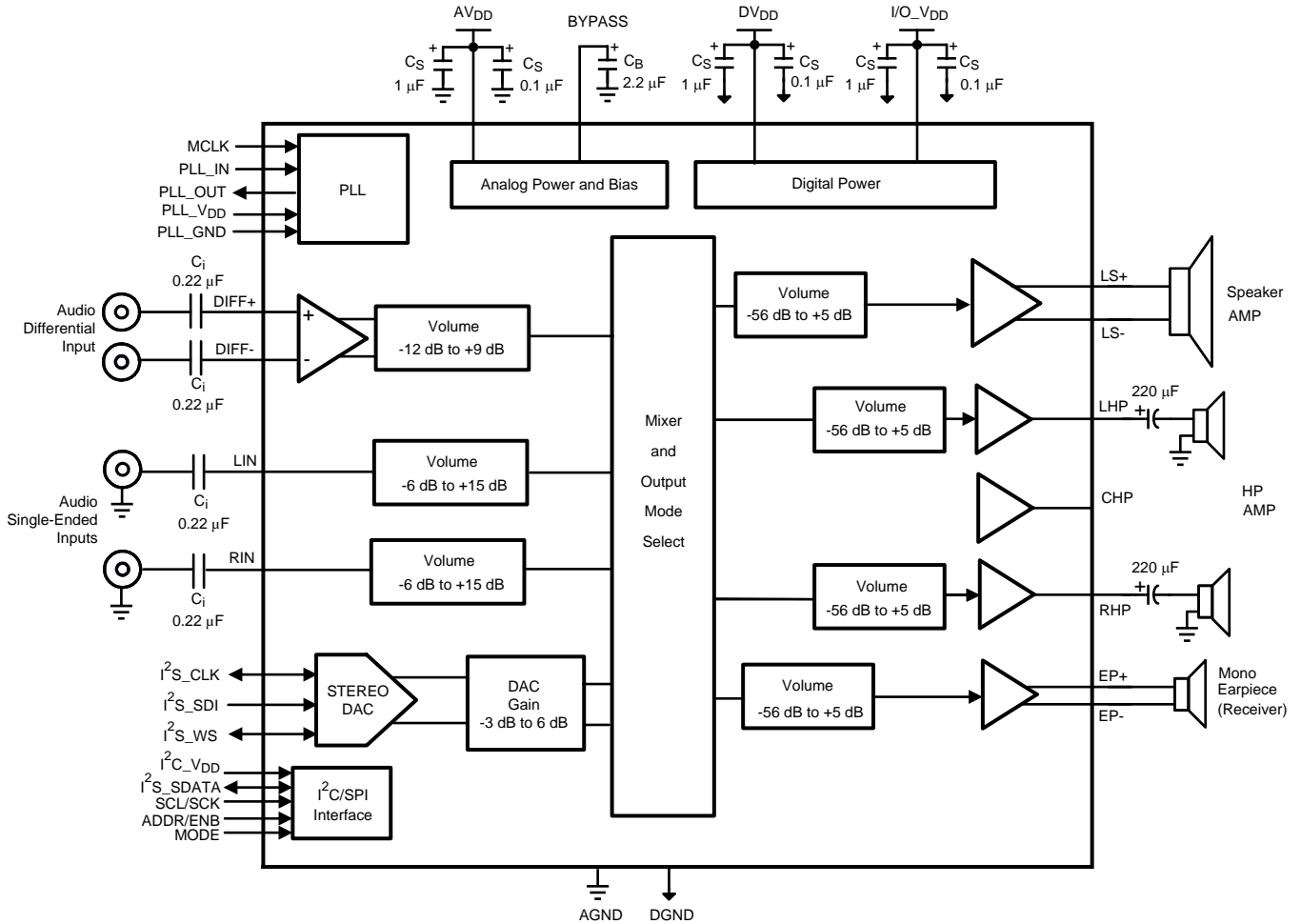


Figure 2. Typical Audio Amplifier Subsystem Application Circuit with Cap-Coupled Single-Ended (SE) Headphone Configuration

Connection Diagram

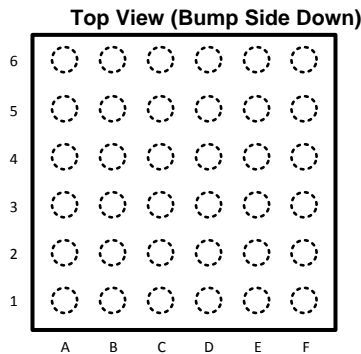


Figure 3. 36 - Bump DSBGA Package See Package Number YPG0036LVA

## PIN DESCRIPTIONS

Pin	Pin Name	Digital /Analog	I/O, Power	Description
A1	DGND	D	P	DIGITAL GND
A2	MCLK	D	I	MASTER CLOCK
A3	I <sup>2</sup> S_WS	D	I/O	I <sup>2</sup> S WORD SELECT
A4	SDA/SDI	D	I/O	I <sup>2</sup> C SDA OR SPI SDI
A5	DV <sub>DD</sub>	D	P	DIGITAL SUPPLY VOLTAGE
A6	I/O_V <sub>DD</sub>	D	P	I/O SUPPLY VOLTAGE
B1	PLL_VDD	D	P	PLL SUPPLY VOLTAGE
B2	I <sup>2</sup> S_SDATA	D	I	I <sup>2</sup> S SERIAL DATA INPUT
B3	I <sup>2</sup> S_CLK	D	I/O	I <sup>2</sup> S CLOCK SIGNAL
B4	GPIO	D	O	TEST PIN (MUST BE LEFT FLOATING)
B5	I <sup>2</sup> C_V <sub>DD</sub>	D	P	I <sup>2</sup> C SUPPLY VOLTAGE
B6	SDL/SCK	D	I	I <sup>2</sup> C_SCL OR SPI_SCK
C1	PLL_GND	D	P	PHASE LOCK LOOP GROUND
C2	PLL_OUT	D	O	PHASE LOCK LOOP FILTER OUTPUT
C3	PLL_IN	D	I	PLL FILTER INPUT
C4	ADDR/ENB	D	I	I <sup>2</sup> C ADDRESS OR SPI ENB DEPENDING ON MODE
C5	BYPASS	A	I	HALF-SUPPLY BYPASS
C6	AV <sub>DD</sub>	A	P	ANALOG SUPPLY VOLTAGE
D1	AGND	A	P	ANALOG GROUND
D2	AGND	A	P	ANALOG GROUND
D3	NC			NO CONNECT (MUST BE LEFT FLOATING)
D4	MODE	D	I	SELECTS BETWEEN I <sup>2</sup> C OR SPI CONTROL
D5	RHP	A	O	RIGHT HEADPHONE OUTPUT
D6	CHP	A	O	HEADPHONE CENTER PIN OUTPUT (1/2 VDD or GND)
E1	DIFF-	A	I	ANALOG NEGATIVE DIFFERENTIAL INPUT
E2	LIN	A	I	ANALOG LEFT CHANNEL INPUT
E3	RIN	A	I	ANALOG RIGHT CHANNEL INPUT
E4	NC			NO CONNECT (MUST BE LEFT FLOATING)
E5	LHP	A	O	LEFT HEADPHONE OUTPUT
E6	AGND	A	P	ANALOG GROUND
F1	DIFF+	A	I	ANALOG POSITIVE DIFFERENTIAL INPUT
F2	EP-	A	O	MONO EARPIECE- OUTPUT
F3	EP+	A	O	MONO EARPIECE+ OUTPUT
F4	LS-	A	O	LOUDSPEAKER OUTPUT-
F5	AV <sub>DD</sub>	A	P	ANALOG SUPPLY VOLTAGE
F6	LS+	A	O	LOUDSPEAKER OUTPUT+



These devices have limited built-in ESD protection. The leads should be shorted together or the device placed in conductive foam during storage or handling to prevent electrostatic damage to the MOS gates.

**Absolute Maximum Ratings<sup>(1)(2)(3)(4)</sup>**

Analog Supply Voltage <sup>(1)</sup>		6.0V
Digital Supply Voltage <sup>(1)</sup>		6.0V
Storage Temperature		-65°C to +150°C
Input Voltage		-0.3V to V <sub>DD</sub> +0.3V
Power Dissipation <sup>(5)</sup>		Internally Limited
ESD Ratings <sup>(6)</sup>		2000V
ESD Ratings <sup>(7)</sup>		200V
Junction Temperature (T <sub>JMAX</sub> )		150°C
Thermal Resistance	θ <sub>JA</sub> (RLA36)	100°C/W

- (1) Absolute Maximum Ratings indicate limits beyond which damage to the device may occur, including inoperability and degradation of device reliability and/or performance. Functional operation of the device and/or non-degradation at the Absolute Maximum Ratings or other conditions beyond those indicated in the Recommended Operating Conditions is not implied. The Recommended Operating Conditions indicate conditions at which the device is functional and the device should not be operated beyond such conditions. All voltages are measured with respect to the ground pin, unless otherwise specified.
- (2) The Electrical Characteristics tables list specified specifications under the listed Recommended Operating Conditions except as otherwise modified or specified by the Electrical Characteristics Conditions and/or Notes. Typical specifications are estimations only and are not ensured.
- (3) Soldering Information: See AN-1279 "Microfill Wafer Level Underfilled Chip Scale package" (Literature Number [SNOA430](#))
- (4) If Military/Aerospace specified devices are required, please contact the Texas Instruments Sales Office/Distributors for availability and specifications.
- (5) Maximum allowable power dissipation is P<sub>DMAX</sub> = (T<sub>JMAX</sub> - T<sub>A</sub>) / θ<sub>JA</sub> or the number given in Absolute Maximum Ratings, whichever is lower.
- (6) Human body model, applicable std. JESD22-A114C.
- (7) Machine model, applicable std. JESD22-A115-A.

**Operating Ratings<sup>(1)(2)</sup>**

Temperature Range (T <sub>MIN</sub> ≤ T <sub>A</sub> ≤ T <sub>MAX</sub> )	-40°C ≤ T <sub>A</sub> ≤ +85°C
Supply Voltage	2.7V ≤ AV <sub>DD</sub> ≤ 5.5V
	2.7V ≤ DV <sub>DD</sub> ≤ 4.0V
	1.7V ≤ I <sup>2</sup> C_V <sub>DD</sub> ≤ 4.0V
	1.7V ≤ I/O_V <sub>DD</sub> ≤ 4.0V

- (1) Absolute Maximum Ratings indicate limits beyond which damage to the device may occur, including inoperability and degradation of device reliability and/or performance. Functional operation of the device and/or non-degradation at the Absolute Maximum Ratings or other conditions beyond those indicated in the Recommended Operating Conditions is not implied. The Recommended Operating Conditions indicate conditions at which the device is functional and the device should not be operated beyond such conditions. All voltages are measured with respect to the ground pin, unless otherwise specified.
- (2) The Electrical Characteristics tables list specified specifications under the listed Recommended Operating Conditions except as otherwise modified or specified by the Electrical Characteristics Conditions and/or Notes. Typical specifications are estimations only and are not ensured.

**Audio Amplifier Electrical Characteristics  $V_{DD} = 3.0V$ ,  $DV_{DD} = 3.0V$ <sup>(1)(2)</sup>**

The following specifications apply for the circuit shown in [Figure 41](#) with all programmable gain set at 0dB, unless otherwise specified. Limits apply for  $T_A = 25^\circ C$ .

Parameter	Test Conditions	LM49321		Units (Limits)	
		Typ <sup>(3)</sup>	Limits <sup>(4)</sup>		
$I_{DD}$	Supply Current	$V_{IN} = 0$ , No Load All Amps On + DAC, OCL <sup>(5)</sup>	13	18	mA (max)
		Headphone Mode Only, OCL, DAC off	4.6	6.25	mA (max)
		Headphone Mode Only, OCL, DAC Off STEREO_OUTPUT_ONLY = 1, STEREO_INPUT_ONLY = 1	4	5.5	mA
		Headphone Mode only OCL, DAC On, OSR = 64, DAC_INPUT_ONLY = 1 STEREO_OUTPUT_ONLY = 1	7.5	10	mA (max)
		Mono Loudspeaker Mode Only	6.5	11.5	mA (max)
		Mono Earpiece Speaker Mode Only MONO_ONLY = 1 (register 01h) MONO_ONLY = 0	3.7 3.3	5	mA (max) mA
		DAC Off, All Amps On (OCL) <sup>(5)</sup>	10	13.5	mA (max)
$I_{SD}$	Shutdown Current	See <sup>(6)</sup>	0.6	1	$\mu A$ (max)
$P_O$	Output Power	Speaker; THD = 1%; $f = 1kHz$ , $8\Omega$ BTL	420	370	mW (min)
		Headphone; THD = 1%; $f = 1kHz$ , $32\Omega$ SE	27	24	mW (min)
		Earpiece; THD = 1%; $f = 1kHz$ , $32\Omega$ BTL	45	40	mW (min)
$V_{FS\ DAC}$	Full Scale DAC Output		2.4		$V_{RMS}$
THD+N	Total Harmonic Distortion+Noise	Speaker; $P_O = 200mW$ ; $f = 1kHz$ , $8\Omega$ BTL	0.04		%
		Headphone; $P_O = 10mW$ ; $f = 1kHz$ , $32\Omega$ SE	0.01		%
		Earpiece; $P_O = 20mW$ ; $f = 1kHz$ , $32\Omega$ BTL	0.04		%
$V_{OS}$	Offset Voltage	Speaker	10	55	mV (max)
		Earpiece	8	50	mV (max)
		Headphone (OCL)	8	15	mV (max)
$\epsilon_O$	Output Noise	A-weighted; 0dB gain	<a href="#">Table 1</a>		
PSRR	Power Supply Rejection Ratio	$f = 217Hz$ ; $V_{RIPPLE} = 200mV_{P-P}$ , $C_B = 2.2\mu F$	<a href="#">Table 2</a>		
$X_{TALK}$	Crosstalk	Headphone; $P_O = 10mW$ , $f = 1kHz$ ; OCL	-60		dB
$T_{WU}$	Wake-Up Time	$C_B = 2.2\mu F$ , $CD\_6 = 0$	35		ms
		$C_B = 2.2\mu F$ , $CD\_6 = 1$	85		ms
CMRR	Common-Mode Rejection Ratio	$f = 217Hz$ , $V_{RMS} = 200mV_{PP}$	56		dB

- (1) Absolute Maximum Ratings indicate limits beyond which damage to the device may occur, including inoperability and degradation of device reliability and/or performance. Functional operation of the device and/or non-degradation at the Absolute Maximum Ratings or other conditions beyond those indicated in the Recommended Operating Conditions is not implied. The Recommended Operating Conditions indicate conditions at which the device is functional and the device should not be operated beyond such conditions. All voltages are measured with respect to the ground pin, unless otherwise specified.
- (2) The Electrical Characteristics tables list specified specifications under the listed Recommended Operating Conditions except as otherwise modified or specified by the Electrical Characteristics Conditions and/or Notes. Typical specifications are estimations only and are not ensured.
- (3) Typical values represent most likely parametric norms at  $T_A = +25^\circ C$ , and at the Recommended Operation Conditions at the time of product characterization and are not ensured.
- (4) Datasheet min/max specification limits are ensured by test or statistical analysis.
- (5) Enabling mono bit (MONO\_ONLY in Output Control Register 01h) will save 400 $\mu A$  (typ) from specified current.
- (6) Shutdown current is measured in a normal room environment.

**Audio Amplifier Electrical Characteristics  $V_{DD} = 5.0V$ ,  $DV_{DD} = 3.3V^{(1)(2)}$** 

The following specifications apply for the circuit shown in [Figure 41](#) with all programmable gain set at 0dB, unless otherwise specified. Limits apply for  $T_A = 25^\circ C$ .

Parameter	Test Conditions	LM49321		Units (Limits)	
		Typ <sup>(3)</sup>	Limits <sup>(4)</sup>		
$I_{DD}$	Supply Current	$V_{IN} = 0$ , No Load All Amps On + DAC, OCL <sup>(5)</sup>	17.5		mA (max)
		Headphone Mode Only, OCL, DAC Off	5.8		mA (max)
		Headphone Mode Only, OCL, DAC Off STEREO_OUTPUT_ONLY = 1, STEREO_INPUT_ONLY = 1	5.5		mA
		Headphone Mode Only, OCL, DAC On, OSR = 64, DAC_INPUT_ONLY = 1 STEREO_OUTPUT_ONLY = 1	9.5		mA
		Mono Loudspeaker Mode Only <sup>(5)</sup>	11.6		mA
		Mono Earpiece Mode Only <sup>(5)</sup>	5		mA
		DAC Off, All Amps On (OCL) <sup>(5)</sup>	12.9		mA
$I_{SD}$	Shutdown Current	See <sup>(6)</sup>	1.6		$\mu A$
$P_O$	Output Power	Speaker; THD = 1%; f = 1kHz, 8 $\Omega$ BTL	1.25		mW
		Headphone; THD = 1%; f = 1kHz, 32 $\Omega$ SE	80		mW
		Earpiece; THD = 1%; f = 1kHz, 32 $\Omega$ BTL	175		mW
$V_{FS\ DAC}$	Full Scale DAC Output		2.4		$V_{RMS}$
THD+N	Total Harmonic Distortion + Noise	Speaker; $P_O = 500mW$ ; f = 1kHz, 8 $\Omega$ BTL	0.03		%
		Headphone; $P_O = 30mW$ ; f = 1kHz, 32 $\Omega$ SE	0.01		%
		Earpiece; $P_O = 40mW$ ; f = 1kHz, 32 $\Omega$ BTL	0.04		%
$V_{OS}$	Offset Voltage	Speaker	10		mV
		Earpiece	8		mV
		HP (OCL)	8		mV
$\epsilon_O$	Output Noise	A-weighted; 0dB gain;	<a href="#">Table 1</a>		
PSRR	Power Supply Rejection Ratio	f = 217Hz; $V_{ripple} = 200mV_{P-P}$ , $C_B = 2.2\mu F$	<a href="#">Table 3</a>		
$X_{TALK}$	Crosstalk	Headphone; $P_O = 15mW$ , f = 1kHz; OCL	-56		dB
$T_{WU}$	Wake-Up Time	$C_B = 2.2\mu F$ , $CD_6 = 0$	45		ms
		$C_B = 2.2\mu F$ , $CD_6 = 1$	130		ms

- (1) Absolute Maximum Ratings indicate limits beyond which damage to the device may occur, including inoperability and degradation of device reliability and/or performance. Functional operation of the device and/or non-degradation at the Absolute Maximum Ratings or other conditions beyond those indicated in the Recommended Operating Conditions is not implied. The Recommended Operating Conditions indicate conditions at which the device is functional and the device should not be operated beyond such conditions. All voltages are measured with respect to the ground pin, unless otherwise specified.
- (2) The Electrical Characteristics tables list specified specifications under the listed Recommended Operating Conditions except as otherwise modified or specified by the Electrical Characteristics Conditions and/or Notes. Typical specifications are estimations only and are not ensured.
- (3) Typical values represent most likely parametric norms at  $T_A = +25^\circ C$ , and at the Recommended Operation Conditions at the time of product characterization and are not ensured.
- (4) Datasheet min/max specification limits are ensured by test or statistical analysis.
- (5) Enabling mono bit (MONO\_ONLY in Output Control Register 01h) will save 400 $\mu A$  (typ) from specified current.
- (6) Shutdown current is measured in a normal room environment.

## Volume Control Electrical Characteristics<sup>(1)(2)</sup>

The following specifications apply for  $3.0V \leq AV_{DD} \leq 5.0V$  and  $2.7V \leq DV_{DD} \leq 4.0V$ , unless otherwise specified. Limits apply for  $T_A = 25^\circ C$ .

Parameter		Test Conditions	LM49321		Units (Limits)
			Typ <sup>(3)</sup>	Limits <sup>(4)</sup>	
PGR	Stereo Analog Inputs Pre-Amp Gain Setting Range	Minimum gain setting	-6	-7	dB (min)
				-5	dB (max)
	Maximum gain setting	15	15.5	dB (max)	
			14.5	dB (min)	
	Differential Mono Analog Input Pre-Amp Gain Setting Range	Minimum gain setting	-12	-13	dB (min)
				-11	dB (max)
Maximum gain setting	9	9.5	dB (max)		
		8.5	dB (min)		
VCR	Output Volume Control for Loudspeaker, Headphone Output, or Earpiece Output	Minimum gain setting	-56	-59	dB (min)
				-53	dB (max)
	Maximum gain setting	+5	4.5	dB (min)	
			5.5	dB (max)	
$\Delta A_{CH-CH}$	Stereo Channel to Channel Gain Mismatch	0.3		dB	
$A_{MUTE}$	Mute Attenuation	$V_{IN} = 1V_{RMS}$ , Gain = 0dB with load, Headphone	-90		dB
$R_{INPUT}$	DIFF+, DIFF-, $L_{IN}$ and $R_{IN}$ Input Impedance		23	18	k $\Omega$ (min)
				28	k $\Omega$ (max)

- (1) Absolute Maximum Ratings indicate limits beyond which damage to the device may occur, including inoperability and degradation of device reliability and/or performance. Functional operation of the device and/or non-degradation at the Absolute Maximum Ratings or other conditions beyond those indicated in the Recommended Operating Conditions is not implied. The Recommended Operating Conditions indicate conditions at which the device is functional and the device should not be operated beyond such conditions. All voltages are measured with respect to the ground pin, unless otherwise specified.
- (2) The Electrical Characteristics tables list specified specifications under the listed Recommended Operating Conditions except as otherwise modified or specified by the Electrical Characteristics Conditions and/or Notes. Typical specifications are estimations only and are not ensured.
- (3) Typical values represent most likely parametric norms at  $T_A = +25^\circ C$ , and at the Recommended Operation Conditions at the time of product characterization and are not ensured.
- (4) Datasheet min/max specification limits are ensured by test or statistical analysis.



**Digital Section Electrical Characteristics<sup>(1)(2)</sup>**

The following specifications apply for  $3.0V \leq AV_{DD} \leq 5.0V$  and  $2.7V \leq DV_{DD} \leq 4.0V$ , unless otherwise specified. Limits apply for  $T_A = 25^\circ C$ .

Parameter		Test Conditions	LM49321		Units (Limits)
			Typ <sup>(3)</sup>	Limits <sup>(4)</sup>	
DI <sub>SD</sub>	Digital Shutdown Current	Mode 0, DV <sub>DD</sub> = 3.0V			
		No MCLK	0.01		μA
DI <sub>DD</sub>	Digital Power Supply Current	f <sub>MCLK</sub> = 12MHz, DV <sub>DD</sub> = 3.0V ALL MODES EXCEPT 0	5.3	6.5	mA (max)
PLLI <sub>DD</sub>	PLL Quiescent Current	f <sub>MCLK</sub> = 12MHz, DV <sub>DD</sub> = 3.0V	4.8	6	mA (max)
<b>Audio DAC (Typical numbers are with 6.144MHz audio clock and 48kHz sampling frequency)</b>					
R <sub>DAC</sub>	Audio DAC Ripple	20Hz - 20kHz through headphone output	+/-0.1		dB
PB <sub>DAC</sub>	Audio DAC Passband width	-3dB point	22.6		kHz
SBA <sub>DAC</sub>	Audio DAC Stop band Attenuation	Above 24kHz	76		dB
DR <sub>DAC</sub>	Audio DAC Dynamic Range	DC - 20kHz, -60dBFS; AES17 Standard	Table 4		dB
SNR	Audio DAC-AMP Signal to Noise Ratio	A-Weighted, Signal = V <sub>O</sub> at 0dBFS, f = 1kHz Noise = digital zero, A-weighted	Table 4		dB
SNR <sub>DAC</sub>	Internal DAC SNR	A-weighted <sup>(5)</sup>	95		dB
<b>PLL</b>					
f <sub>IN</sub>	Input Frequency on MCLK pin		12	10	MHz
				26	
<b>SPI/I<sup>2</sup>C (1.7V ≤ I<sup>2</sup>C_V<sub>DD</sub> ≤ 2.2V)</b>					
f <sub>SPI</sub>	Maximum SPI Frequency			1000	kHz (max)
t <sub>SPISETD</sub>	SPI Data Setup Time			250	ns (max)
t <sub>SPISETENB</sub>	SPI ENB Setup Time			250	ns (max)
t <sub>SPIHOLDD</sub>	SPI Data Hold Time			250	ns (max)
t <sub>SPIHOLDENB</sub>	SPI ENB Hold Time			250	ns (max)
t <sub>SPICL</sub>	SPI Clock Low Time			500	ns (max)
t <sub>SPICH</sub>	SPI Clock High Time			500	ns (max)
f <sub>CLKI2C</sub>	I <sup>2</sup> C_CLK Frequency			400	kHz (max)
t <sub>I2CHOLD</sub>	I <sup>2</sup> C_DATA Hold Time			250	ns (max)
t <sub>I2CSET</sub>	I <sup>2</sup> C_DATA Setup Time			250	ns (max)
V <sub>IH</sub>	I <sup>2</sup> C/SPI Input High Voltage		I <sup>2</sup> C_V <sub>DD</sub>	0.7 × I <sup>2</sup> C_V <sub>DD</sub>	V (min)
V <sub>IL</sub>	I <sup>2</sup> C/SPI Input Low Voltage		0	0.25 × I <sup>2</sup> C_V <sub>DD</sub>	V (max)
<b>SPI/I<sup>2</sup>C (2.2V ≤ I<sup>2</sup>C_V<sub>DD</sub> ≤ 4.0V)</b>					
f <sub>SPI</sub>	Maximum SPI Frequency			4000	kHz (max)
t <sub>SPISETD</sub>	SPI Data Setup Time			100	ns (max)
t <sub>SPISETENB</sub>	SPI ENB Setup Time			100	ns (max)
t <sub>SPIHOLDD</sub>	SPI Data Hold Time			100	ns (max)
t <sub>SPIHOLENB</sub>	SPI ENB Hold Time			100	ns (max)

- (1) Absolute Maximum Ratings indicate limits beyond which damage to the device may occur, including inoperability and degradation of device reliability and/or performance. Functional operation of the device and/or non-degradation at the Absolute Maximum Ratings or other conditions beyond those indicated in the Recommended Operating Conditions is not implied. The Recommended Operating Conditions indicate conditions at which the device is functional and the device should not be operated beyond such conditions. All voltages are measured with respect to the ground pin, unless otherwise specified.
- (2) The Electrical Characteristics tables list specified specifications under the listed Recommended Operating Conditions except as otherwise modified or specified by the Electrical Characteristics Conditions and/or Notes. Typical specifications are estimations only and are not ensured.
- (3) Typical values represent most likely parametric norms at  $T_A = +25^\circ C$ , and at the Recommended Operation Conditions at the time of product characterization and are not ensured.
- (4) Datasheet min/max specification limits are ensured by test or statistical analysis.
- (5) Internal DAC only with DAC modes 00 and 01.

**Digital Section Electrical Characteristics<sup>(1)(2)</sup> (continued)**

The following specifications apply for  $3.0V \leq AV_{DD} \leq 5.0V$  and  $2.7V \leq DV_{DD} \leq 4.0V$ , unless otherwise specified. Limits apply for  $T_A = 25^\circ C$ .

Parameter		Test Conditions	LM49321		Units (Limits)
			Typ <sup>(3)</sup>	Limits <sup>(4)</sup>	
$t_{SPICL}$	SPI Clock Low Time			125	ns (max)
$t_{SPICH}$	SPI Clock High Time			125	ns (max)
$f_{CLKI2C}$	I <sup>2</sup> C_CLK Frequency			400	kHz (max)
$t_{I2CHOLD}$	I <sup>2</sup> C_DATA Hold Time			100	ns (max)
$t_{I2CSET}$	I <sup>2</sup> C_DATA Setup Time			100	ns (max)
$V_{IH}$	I <sup>2</sup> C/SPI Input High Voltage		$I^2C\_V_{DD}$	$0.7 \times I^2C\_V_{DD}$	V (min)
$V_{IL}$	I <sup>2</sup> C/SPI Input Low Voltage		0	$0.3 \times I^2C\_V_{DD}$	V (max)
<b>I<sup>2</sup>S(1.7V ≤ I/O_V<sub>DD</sub> ≤ 2.7V)</b>					
$f_{CLKI^2S}$	I <sup>2</sup> S_CLK Frequency	$I^2S\_RESOLUTION = 1$ $I^2S\_RESOLUTION = 0$	1536 3072	6144 12288	kHz (max) kHz (max)
	I <sup>2</sup> S_WS Duty Cycle		50	40 60	% (min) % (max)
$V_{IH}$	Digital Input High Voltage			$0.75 \times I/O\_V_{DD}$	V (min)
$V_{IL}$	Digital Input Low Voltage			$0.25 \times I/O\_V_{DD}$	V (max)
<b>I<sup>2</sup>S(2.7V ≤ I/O_V<sub>DD</sub> ≤ 4.0V)</b>					
$f_{CLKI^2S}$	I <sup>2</sup> S_CLK Frequency	$I^2S\_RESOLUTION = 0$	1536 3072	6144 12288	kHz (max) kHz (max)
	I <sup>2</sup> S_WS Duty Cycle	$I^2S\_RESOLUTION = 1$	50	40 60	% %
$V_{IH}$	Digital Input High Voltage			$0.7 \times I/O\_V_{DD}$	V (min)
$V_{IL}$	Digital Input Low Voltage			$0.3 \times I/O\_V_{DD}$	V (max)

**Table 1. Output Noise  $AV_{DD} = 5.0V$  and  $AV_{DD} = 3.0V$ . All gains set to 0dB. Units in  $\mu V$ , A-weighted, Inputs terminated to ground.**

MODE	EP	LS	HP OCL	Units
1	22	22	8	$\mu V$
2	22	22	8	$\mu V$
3	22	22	8	$\mu V$
4	68	88	46	$\mu V$
5	38	48	24	$\mu V$
6	29	34	18	$\mu V$
7	38	48	24	$\mu V$

**Table 2. VPSRR  $AV_{DD} = 3.0V$ ,  $f_{RIPPLE} = 217Hz$ ;  $V_{RIPPLE} = 200mV_{P-P}$ ;  $C_B = 2.2\mu F$ ; All gains set to 0dB.**

MODE	EP(Typ)	LS (Typ)	LS (Limit)	HP (Typ)	HP (Limit)	Units
1	69	76		72		dB
2	69	76	67	72	68	dB
3	69	76		72		dB
4	63	62		55		dB
5	69	68		61		dB
6	69	70		64		dB
7	69	68		61		dB

**Table 3. PSRR  $AV_{DD} = 5.0V$ ,  $f_{RIPPLE} = 217Hz$ ;  $V_{RIPPLE} = 200mV_{P-P}$ ;  $C_B = 2.2\mu F$ ; All gains set to 0dB.**

MODE	EP (Typ)	LS (Typ)	HP (Typ)	Units
1	68	72	71	dB
2	68	72	71	dB
3	68	72	71	dB
4	68	66	69	dB
5	68	69	70	dB
6	69	72	71	dB
7	68	69	70	dB

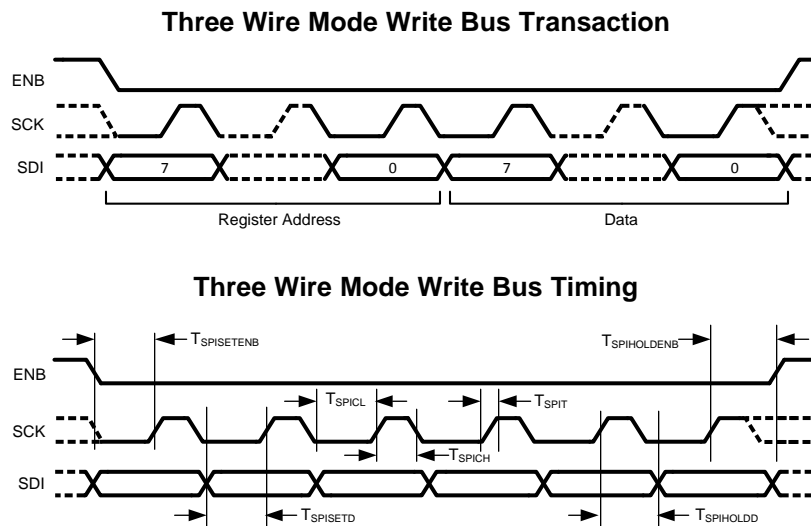
**Table 4. Dynamic Range and SNR.  $3.0V \leq AV_{DD} \leq 5.0V$ . All programmable gain set to 0dB. Units in dB.**

	DR (Typ)	SNR (Typ)	Units
LS	95	85	dB
HP	95	85	dB
EP	97	85	dB

### System Control

The LM49321 is controlled via either a two wire I<sup>2</sup>C compatible interface or three wire SPI interface, selectable with the MODE pin. This interface is used to configure the operating mode, interfaces, data converters, mixers and amplifiers. The LM49321 is controlled by writing 8 bit data into a series of write-only registers, the device is always a slave for both type of interfaces.

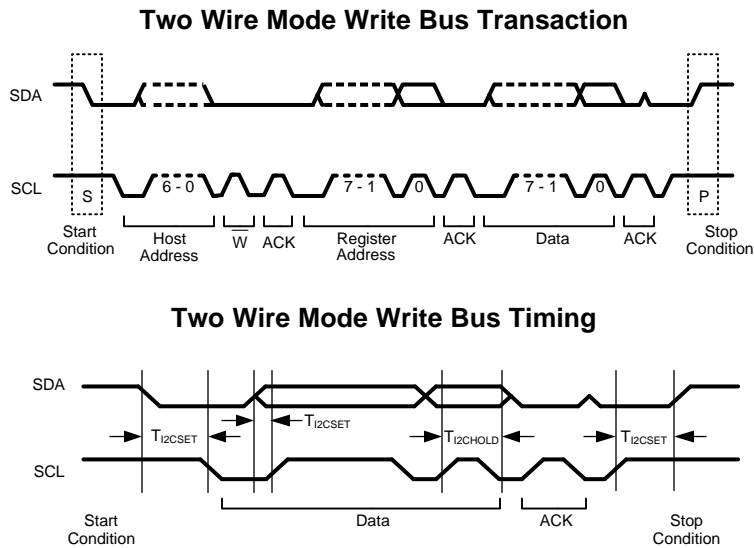
#### THREE WIRE, SPI INTERFACE (MODE = 1)



**Figure 4. Three Wire Mode Write Bus**

When the part is configured as an SPI device and the enable (ENB) line is lowered the serial data on SDI is clocked in on the rising edge of the SCK line. The protocol used is 16bit, MSB first. The upper 8 bits (15:8) are used to select an address within the device, the lower 8 bits (7:0) contain the updated data for this register.

**TWO WIRE I<sup>2</sup>C COMPATIBLE INTERFACE (MODE = 0)**



**Figure 5. Two Wire Mode Write Bus**

When the part is configured as an I<sup>2</sup>C device then the LM49321 will respond to one of two addresses, according to the ADDR input. If ADDR is low then the address portion of the I<sup>2</sup>C transaction should be set to write to 0010000. When ADDR is high then the address input should be set to write to 1110000.

**Table 5. Chip Address**

	A7	A6	A5	A4	A3	A2	A1	A0
Chip Address	0	EC	EC	1	0	0	0	0
ADR = 0	0	0	0	1	0	0	0	0
ADR = 1	0	1	1	1	0	0	0	0

EC — Externally configured by ADR pin

**Table 6. Control Registers**

Address	Register	D7	D6	D5	D4	D3	D2	D1	D0
00h	MODE_CONTROL	0	CD_6	0	OCL	MODE_CONTROL			
01h	OUTPUT_CONTROL	STEREO_OUT_ONLY	MONO_ONLY	DAC_INPUT_ONLY	STEREO_INPUT_ONLY	HP_R_OUTPUT	HP_L_OUTPUT	LS_OUTPUT	MONO_OUTPUT
02h	EP_VOL	0	0	0	EP_VOL				
03h	LS_VOL	0	0	0	LS_VOL				
04h	RESERVED	0	0	0	0	0	0	0	0
05h	HP_L_VOL	0	0	0	HP_L_VOL				
06h	HP_R_VOL	0	0	0	HP_R_VOL				
07h	ANALOG_INPUT_GAIN	0	0	ANA_R_GAIN			ANA_L_GAIN		
08h	ANALOG_DAC_GAIN	0	DAC_R_GAIN		DAC_L_GAIN		MONO_L_GAIN		
09h	CLOCKS	R_DIV				PLL_ENABLE	AUDIO_CLK_SEL	PLL_INPUT	FAST_CLOCK
0Ah	PLL_M	0	PLL_M						
0Bh	PLL_N								
0Ch	PLL_N_MOD	VCO_FAS_T	DITHER_LEVEL	DITHER_LEVEL	PLL_N_MOD				
0Dh	PLL_P	0	0	0	0	PLL_P			
0Eh	DAC_SETUP	0	CUST_COMP	DITHER_ALW_ON	DITHER_OFF	MUTE_R	MUTE_L	DAC_MODE	
0Fh	INTERFACE	0	0	0	0	I <sup>2</sup> C_FAST	I <sup>2</sup> S_MODE	I <sup>2</sup> S_RESOLUTION	I <sup>2</sup> S_MASTER_SLAVE
10h	COMPENSATION_C OEFF0_LSB								
11h	COMPENSATION_C OEFF0_MSB								
12h	COMPENSATION_C OEFF1_LSB								
13h	COMPENSATION_C OEFF1_MSB								
14h	COMPENSATION_C OEFF2_LSB								
15h	COMPENSATION_C OEFF2_MSB								

### Mixer Control Registers

This register is used to control the different mixer modes that the LM49321 supports.

**Table 7. Mode Control Register (00h)<sup>(1)</sup>**

Bits	Field	Description					
3:0	MODE_CONTROL	This sets the different mixer output modes.					
		MODE_CONTROL	Mode	Mono Earpiece	Loudspeaker	Headphone Left	Headphone Right
		0000	0	SD	SD	SD	SD
		1001	1	M	M	M	M
		1010	2	AL+AR	AL+AR	AL	AR
		1011	3	M+AL+AR	M+AL+AR	M+AL	M+AR
		1100	4	DL+DR	DL+DR	DL	DR
		1101	5	DL+DR+AL+AR	DL+DR+AL+AR	DL+AL	DR+AR
		1110	6	M+DL+DR+AL+AR	M+DL+DR+AL+AR	M+DL+AL	M+DR+AR
1111	7	M+DL+DR	M+DL+DR	M+DL	M+DR		
4	OCL	This sets the headphone output to use output capacitor-less configuration.					
		OCL			Headphone output configuration		
		0			Cap-coupled Single-ended Mode (SE)		
		1			Output capacitor-less (OCL)		

- (1) SD — Shutdown  
 M — Mono Differential Input  
 AL — Analog Left Channel  
 AR — Analog Right Channel  
 DL — I2S DAC Left Channel  
 DR — I2S DAC Right Channel  
 Note: Power-On Default Mode is Mode 0

This register is used to control the different output configurations.

**Table 8. Output Control (01h)**

Bits	Field	Description	
0	EP_OUTPUT	This enables the Mono Earpiece output.	
		EP_OUTPUT	Status
		0	Mono earpiece output off
		1	Mono earpiece output on
1	LS_OUTPUT	This enables the Mono Loudspeaker output.	
		LS_OUTPUT	Status
		0	Loudspeaker output off
		1	Loudspeaker output on
2	HP_L_OUTPUT	This enables the Headphone left output.	
		HP_L_OUTPUT	Status
		0	Headphone left output off. If OCL=1, output is in mute.
		1	Headphone left output on
3	HP_R_OUTPUT	This enables the Headphone right output.	
		HP_R_OUTPUT	Status
		0	Headphone right output off. If OCL=1, output is in mute.
		1	Headphone right output on

**Table 8. Output Control (01h) (continued)**

Bits	Field	Description	
4	STEREO_INPUT_ONLY	This enables the analog left (AL) and analog right (AR) and disables all other inputs.	
		STEREO_INPUT_ONLY	Status
		0	Normal
		1	Enables AL and AR inputs only
5	DAC_INPUT_ONLY	This enables the DAC left (DL) and analog right (DR) and disables all other inputs.	
		DAC_INPUT_ONLY	Status
		0	Normal
		1	Enables DL and DR inputs only
6	MONO_ONLY	This enables mono earpiece (EP) and loudspeaker (LS) outputs MUX and disables the headphone outputs MUX. Enabling this mode can save up to 400 $\mu$ A of current.	
		MONO_ONLY	Status
		0	Normal
		1	Enable mono earpiece and loudspeaker outputs MUX
7	STEREO_OUTPUT_ONLY	This enables the headphone output MUX only and disables all other output MUX's. Enabling this mode can save up to 200 $\mu$ A of current.	
		STEREO_OUTPUT_ONLY	Status
		0	Normal
		1	Enables the headphone output MUX

## Volume Control Registers

These registers are used to control output volume control levels for Earpiece, Loudspeaker and Headphone.

**Table 9. Volume Control Register**  
**EP\_VOL (02h), LS\_VOL (03h), HP\_L\_VOL (05h), HP\_R\_VOL (06h)**

Bits	Field	Description	
4:0	EP_VOL LS_VOL HP_L_VOL HP_R_VOL	This programs the Earpiece, Loudspeaker and Headphone volume level.	
		VOL	Level (dB)
		00000	MUTE
		00001	-56
		00010	-52
		00011	-48
		00100	-45
		00101	-42
		00110	-39
		00111	-36
		01000	-33
		01001	-30
		01010	-28
		01011	-26
		01100	-24
		01101	-22
		01110	-20
		01111	-18
		10000	-16
		10001	-14
		10010	-12
		10011	-10
		10100	-8
		10101	-6
		10110	-4
		10111	-3
11000	-2		
11001	-1		
11010	0		
11011	1		
11100	2		
11101	3		
11110	4		
11111	5		



This register is used to control input gain for left and right analog inputs.

**Table 10. Analog Left and Right Input Control (07h)**

Bits	Field	Description	
2:0	ANA_L_GAIN	This program the analog left input gain.	
		ANA_L_GAIN	Level (dB)
		000	–6
		001	–3
		010	0
		011	3
		100	6
		101	9
		110	12
		111	15
5:3	ANA_R_GAIN	This program the analog Right input gain.	
		ANA_R_GAIN	Level (dB)
		000	–6
		001	–3
		010	0
		011	3
		100	6
		101	9
		110	12
		111	15

This register is used to control input gain for Mono, DAC left and right inputs.

**Table 11. Mono and DAC Input Gain Control (08h)**

Bits	Field	Description	
2:0	MONO_IN_GAIN	This program the mono input gain.	
		MONO_IN_GAIN	Level (dB)
		000	–12
		001	–9
		010	–6
		011	–3
		100	0
		101	3
		110	6
		111	9
4:3	DAC_L_GAIN	This program the DAC left input gain.	
		DAC_L_GAIN	Level (dB)
		00	–3
		01	0
		10	3
		11	6

**Table 11. Mono and DAC Input Gain Control (08h) (continued)**

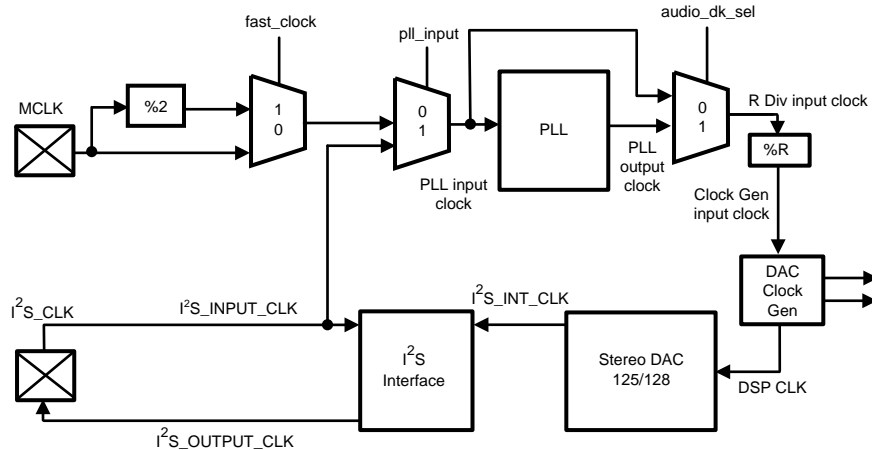
Bits	Field	Description	
6:5	DAC_R_GAIN	This program the DAC Right input gain.	
		DAC_R_GAIN	Level (dB)
		00	-3
		01	0
		10	3
		11	6

### Clock Configuration Register

This register is used to control the multiplexers and clock R divider in the clock module.

**Table 12. CLOCK (09h)**

Bits	Register	Description	
0	FAST_CLOCK	If set master clock is divided by two.	
		FAST_CLOCK	MCLK Frequency
		0	Normal
		1	Divided by 2
1	PLL_INPUT	Programs the PLL input multiplexer to select:	
		PLL_INPUT	PLL Input Source
		0	MCLK
		1	I <sup>2</sup> S Input Clock
2	AUDIO_CLK_SEL	Selects which clock is passed to the audio sub-system	
		DAC_CLK_SEL	DAC Sub-system Input Source
		0	PLL Input
		1	PLL Output
3	PLL_ENABLE	If set enables the PLL. (MODES 4–7 only)	
7:4	R_DIV	Programs the R divider	
		R_DIV	Divide Value
		0000	1
		0001	1
		0010	1.5
		0011	2
		0100	2.5
		0101	3
		0110	3.5
		0111	4
		1000	4.5
		1001	5
		1010	5.5
		1011	6
		1100	6.5
1101	7		
1110	7.5		
		1111	8



By default the stereo DAC operates at  $250 \cdot f_s$ , i.e. 12.000MHz (at the clock generator input clock) for 48kHz data. It is expected that the PLL be used to drive the audio system unless a 12.000MHz master clock is supplied. The PLL can also use the I2S clock input as a source. In this case, the audio DAC uses the clock from the output of the PLL.

### Common Clock Settings for the DAC

The DAC can work in 4 modes, each with different oversampling rates, 125,128,64 and 32. In normal operation 125x oversampling provides for the simplest clocking solution as it will work from 12.000MHz (common in most systems with Bluetooth or USB) at 48kHz exactly. The other modes are useful if data is being provided to the DAC from an uncontrollable isochronous source (such as a CD player, DAB, or other external digital source) rather than being decoded from memory. In this case the PLL can be used to derive a clock for the DAC from the I2S clock.

The DAC oversampling rate can be changed to allow simpler clocking strategies, this is controlled in the DAC SETUP register but the oversampling rates are as follows:

DAC MODE	Over sampling Ratio Used
00	125
01	128
10	64
11	32

The following table describes the clock required at the clock generator input for various clock sample rates in the different DAC modes:

Fs (kHz)	DAC Oversampling Ratio	Required CLock at DAC Clock Generator Input (MHz)
8	125	2
8	128	2.048
11.025	125	2.75625
11.025	128	2.8224
12	125	3
12	128	3.072
16	125	4
16	128	4.096
22.05	125	5.5125
22.05	128	5.6448
24	125	6
24	128	6.144

Fs (kHz)	DAC Oversampling Ratio	Required CLock at DAC Clock Generator Input (MHz)
32	125	8
32	128	8.192
44.1	125	11.025
44.1	128	11.2896
48	125	12
48	128	12.288
88.2	64	11.2896
96	64	12.288
176.4	32	22.5792
192	32	24.576

Methods for producing these clock frequencies are described in the [PLL](#) section.

The R divider can be used when the master clock is exactly 12.00 MHz in order to generate different sample rates. The Table below shows different sample rates supported from 12.00MHz by using only the R divider and disabling the PLL. In this way we can save power and the clock jitter will be low.

R_DIV	Divide Value	DAC Clock Generator Input Frequency <MHz>	Sample Rate Supported <KHz>
11	6	2	8
9	5	2.4	9.6
7	4	3	12
5	3	4	16
4	2.5	4.8	19.2
3	2	6	24
2	1.5	8	32
0	1	12	48

The R divider can also be used along with the P divider in order to create the clock needed to support low sample rates.

## PLL Configuration Registers

### PLL M DIVIDER CONFIGURATION REGISTER

This register is used to control the input divider of the PLL.

**Table 13. PLL\_M (0Ah)<sup>(1)</sup>**

Bits	Register	Description	
6:0	PLL_M	Programs the PLL input divider to select:	
		PLL_M	Divide Ratio
		0000000	Divider Off
		0000001	1
		0000010	1.5
		0000011	2
		0000100	2.5
		...	...
1111110	63.5		

(1) The M divider should be set such that the output of the divider is between 0.5 and 5MHz. See the PLL setup section for details.  
The division of the M divider is derived from PLL\_M as such:  
 $M = (PLL\_M + 1) / 2$

## PLL N DIVIDER CONFIGURATION REGISTER

This register is used to control PLL N divider.

**Table 14. PLL\_N (0Bh)<sup>(1)</sup>**

Bits	Register	Description	
7:0	PLL_N	Programs the PLL feedback divider:	
		PLL_N	Divide Ratio
		00000000	Divider Off
		00000001 → 00001010	10
		00001011	11
		00001100	12
		...	...
		11111000	248
11111001	249		

(1) The N divider should be set such that the output of the divider is between 0.5 and 5MHz. See the PLL setup section for details. The N divider should never be set so that  $(F_{in}/M) * N > 55\text{MHz}$  (or 80MHz if FAST\_VCO is set in the PLL\_N\_MOD register).

The non-sigma-delta division of the N divider is derived from the PLL\_N as such:

$$N = \text{PLL\_N}$$

$F_{in}/M$  is often referred to as  $F_{comp}$  (Frequency of Comparison) or  $F_{ref}$  (Reference Frequency). In this document,  $F_{comp}$  is used

## PLL P DIVIDER CONFIGURATION REGISTER

This register is used to control the PLL's P divider.

**Table 15. PLL\_P<sup>(1)</sup>**

Bits	Register	Description	
3:0	PLL_P	Programs the PLL input divider to select:	
		0000	Divider Off
		0001	1
		0010	1.5
		0011	2
		...	→ 2.5
		1101	7
		1110	7.5
1111	8		

(1) The output of this divider should be either 12 or 24MHz in USB mode or 11.2896MHz, 12.288MHz or 24.576MHz in non-USB modes.

The division of the P divider is derived from PLL\_P as such:

$$P = (\text{PLL\_P} + 1) / 2$$

**PLL N MODULATOR AND DITHER SELECT CONFIGURATION REGISTER**

This register is used to control the Fractional component of the PLL.

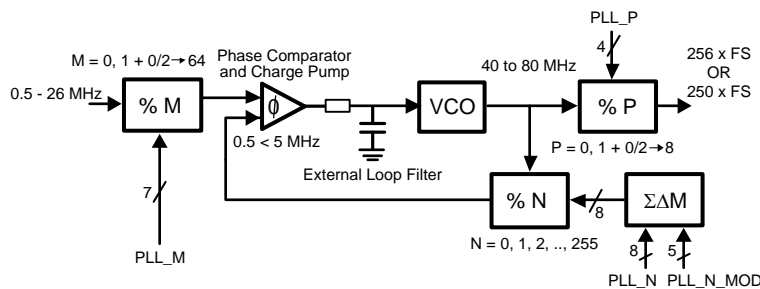
**Table 16. PLL\_N\_MOD (0Ch)<sup>(1)</sup>**

Bits	Register	Description	
4:0	PLL_N_MOD	This programs the PLL N Modulator's fractional component:	
		PLL_N_MOD	Fractional Addition
		00000	0/32
		00001	1/32
		00010 → 11110	2/32 → 30/32
6:5	DITHER_LEVEL	Allows control over the dither used by the N Modulator	
		DITHER_LEVEL	DAC Sub-system Input Source
		00	Medium (32)
		01	Small (16)
		10	Large (48)
7	VCO_FAST	If set the VCO maximum and minimum frequencies are raised:	
		VCO_FAST	Maximum F <sub>VCO</sub>
		0	40–55MHz

- (1) The complete N divider is a fractional divider as such:  
 $N = PLL\_N + (PLL\_N\_MOD/32)$   
 If the modulus input is zero, then the N divider is simply an integer N divider. The output from the PLL is determined by the following formula:  
 $F_{out} = (F_{in} * N) / (M * P)$   
 Please see over for more details on the PLL and common settings.

**Further Notes on PLL Programming**

The sigma-delta PLL is designed to drive audio circuits requiring accurate clock frequencies of up to 25MHz with frequency errors noise-shaped away from the audio band. The 5 bits of modulus control provide exact synchronization of 48kHz and 44.1kHz sample rates from any common clock source when the oversampling rate of the audio system is 125fs. In systems where 128x oversampling must be used (for example with an isochronous I<sup>2</sup>S data stream) a clock synchronous to the sample rate should be used as input to the PLL (typically the I<sup>2</sup>S clock). If no isochronous source is available then the PLL can be used to obtain a clock that is accurate to within typical crystal tolerances of the real sample rate.



**Table 17. Example Of PLL Settings For 48Khz Sample Rates**

f_in (MHz)	fsamp (kHz)	M	N	P	PLL_M	PLL_N	PLL_N_MOD	PLL_P	f_out (MHz)
11	48	11	60	5	21	60	0	9	12
12	48	5	25	5	9	25	0	9	12
12.288	48	4	19.53125	5	7	19	17	9	12
13	48	13	60	5	25	60	0	9	12
14.4	48	9	37.5	5	17	37	16	9	12
16.2	48	27	100	5	53	100	0	9	12
16.8	48	14	50	5	27	50	0	9	12
19.2	48	13	40.625	5	25	40	20	9	12
19.44	48	27	100	6	53	100	0	11	12
19.68	48	20.5	62.5	5	40	62	16	9	12
19.8	48	16.5	50	5	32	50	0	9	12

**Table 18. Example PLL Settings For 44.1Khz Sample Rates**

f_in (MHz)	fsamp (kHz)	M	N	P	PLL_M	PLL_N	PLL_N_MOD	PLL_P	f_out (MHz)
11	44.1	11	55.125	5	21	55	4	9	11.025000
11.2896	44.1	8	39.0625	5	15	39	2	9	11.025000
12	44.1	5	22.96875	5	9	22	31	9	11.025000
13	44.1	13	55.125	5	25	55	4	9	11.025000
14.4	44.1	12	45.9375	5	23	45	30	9	11.025000
16.2	44.1	9	30.625	5	17	30	20	9	11.025000
16.8	44.1	17	55.78125	5	33	55	25	9	11.025000
19.2	44.1	16	45.9375	5	31	45	30	9	11.025000
19.44	44.1	13.5	38.28125	5	26	38	9	9	11.025000
19.68	44.1	20.5	45.9375	4	40	45	30	7	11.025000
19.8	44.1	11	30.625	5	21	30	20	9	11.025000

These tables cover the most common applications, obtaining clocks for sample rates such as 22.05kHz and 192kHz should be done by changing the P divider value or the R divider in the clock configuration diagram.

If the user needs to obtain a clock unrelated to those described above, the following method is advised. An example of obtaining 11.2896 from 12.000MHz is shown below.

Choose a small range of P so that the VCO frequency is swept between 45 and 55MHz (or 60-80MHz if VCOFAST is used). Remembering that the P divider can divide by half integers. So for  $P = 4.0 \rightarrow 7.0$  sweep the M inputs from  $2.5 \rightarrow 24$ . The most accurate N and N\_MOD can be calculated by:

$$N = \text{FLOOR}(((F_{out}/F_{in}) * (P * M)), 1)$$

$$N\_MOD = \text{ROUND}(32 * (((F_{out}/F_{in}) * (P * M) - N), 0)$$

This shows that setting  $M = 11.5$ ,  $N = 75$ ,  $N\_MOD = 47$ ,  $P = 7$  gives a comparison frequency of just over 1MHz, a VCO frequency of just under 80MHz (so VCO\_FAST must be set) and an output frequency of 11.289596 which gives a sample rate of 44.099985443kHz, or accurate to 0.33 ppm.

Care must be taken when synchronization of isochronous data is not possible, i.e. when the PLL has to be used in the above mode. The I2S should be master on the LM49321 so that the data source can support appropriate SRC as required. This method should only be used with data being read on demand to eliminate sample rate mismatch problems.

Where a system clock exists at an integer multiple of the required DAC clock rate it is preferable to use this rather than the PLL. The LM49321 is designed to work in 8,12,16,24,32, and 48kHz modes from a 12MHz clock without the use of the PLL. This saves power and reduces clock jitter.

## DAC Setup Register

This register is used to configure the basic operation of the stereo DAC.

**Table 19. DAC\_SETUP (0Eh)**

Bits	Register	Description			
1:0	DAC_MODE	The DAC used in the LM49321 can operate in one of 4 oversampling modes. The modes are described as follows:			
		DAC_MODE	Oversampling Rate	Typical $f_s$	MCLK Required
		00	125	48KHz	12.000MHz (USB Mode)
		01	128	44.1KHz 48KHz	11.2896MHz 12.288MHz
		10	64	96KHz	12.288MHz
		11	32	192KHz	24.576MHz
2	MUTE_L	Mutes the left DAC channel on the next zero crossing.			
3	MUTE_R	Mutes the right DAC channel on the next zero crossing.			
4	DITHER_OFF	If set the dither in DAC is disabled.			
5	DITHER ALWAYS_ON	If set the dither in DAC is enabled all the time.			
6	CUST_COMP	If set the DAC frequency response can be programmed manually via a 5 tap FIR "compensation" filter. This can be used to enhance the frequency response of small loudspeakers or provide a crude tone control. The compensation Coefficients can be set by using registers 10h to 15h.			

## Interface Control Register

This register is used to control the I<sup>2</sup>S and I<sup>2</sup>C compatible interface on the chip.

**Table 20. INTERFACE (0Fh)<sup>(1)</sup>**

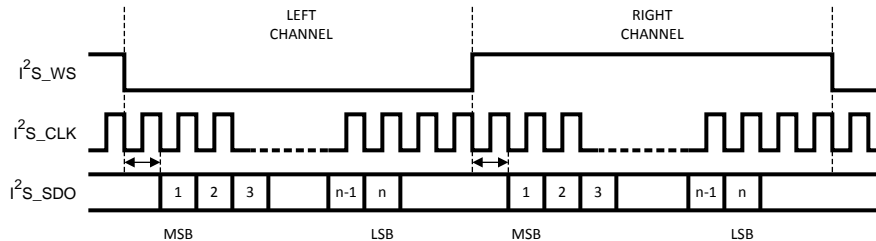
Bits	Field	Description	
0	I <sup>2</sup> S_MASTER_SLAVE	This enables I <sup>2</sup> S in master or slave mode.	
		I <sup>2</sup> S_MASTER_SLAVE	Comments
		0	LM49321 acts as a slave where both I <sup>2</sup> S clock and word select are configured as inputs.
		1	LM49321 acts as a master for I <sup>2</sup> S, so both I <sup>2</sup> S clock and I <sup>2</sup> S word select are configured as outputs.
1	I <sup>2</sup> S_RESOLUTION	This set the I <sup>2</sup> S resolution and affects the I <sup>2</sup> S Interface in master mode. In slave mode the I <sup>2</sup> S Interface can support any I <sup>2</sup> S compatible resolution. In master mode the I <sup>2</sup> S resolution also depends on the DAC mode as the note below explains.	
		I <sup>2</sup> S_RESOLUTION	Comments
		0	I <sup>2</sup> S resolution is set to 16 bits.
		1	I <sup>2</sup> S resolution is set to 32 bits.
2	I <sup>2</sup> S_MODE	This set the I <sup>2</sup> S mode timing.	
		I <sup>2</sup> S_MODE	Comments
		0	I <sup>2</sup> S interface is configured in normal I <sup>2</sup> S mode timing.
		1	I <sup>2</sup> S is configured in left justified mode timing.

(1) The master I2S format depends on the DAC mode. In USB mode the number of bits per word is 25 (i.e. 2.4MHz for a 48kHz sample rate). The duty cycle is 40/60. In non-USB modes the format is 32 or 16 bits per word, depending on I2S\_RESOLUTION and the duty cycle is always 50-50. In slave mode it will decode any I2S compatible data stream.

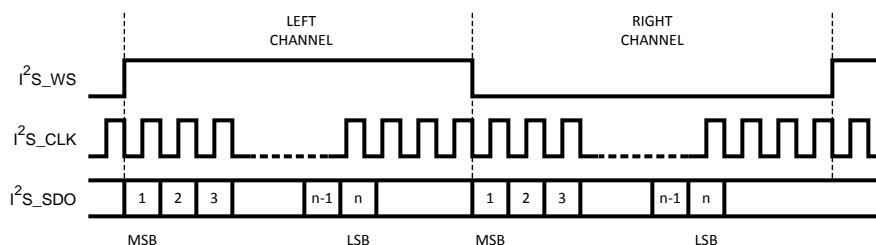


**Table 20. INTERFACE (0Fh)<sup>(1)</sup> (continued)**

Bits	Field	Description	
3	I <sup>2</sup> C_FAST	This set the I <sup>2</sup> C Clock speed.	
		I <sup>2</sup> C_FAST	Comments
		0	I <sup>2</sup> C speed gets its default value of a maximum of 400kHz.
		1	This enables the I <sup>2</sup> C to run in fast mode with an I <sup>2</sup> C clock up to 3.4MHz.



**Figure 6. I<sup>2</sup>S Mode Timing**



**Figure 7. Left Justified Mode Timing**

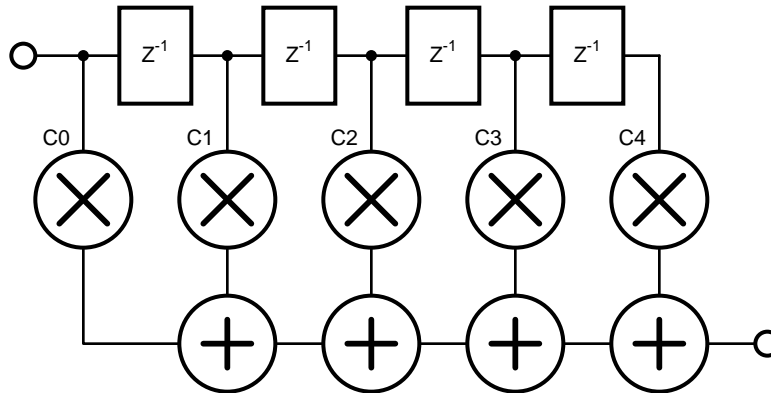
### FIR Compensation Filter Configuration Registers

These registers are used to configure the DAC's FIR compensation filter. Three 16 bit coefficients are required and must be programmed via the I<sup>2</sup>C/SPI Interface in bytes as follows:

**Table 21. COMP\_COEFF (10h → 15h)<sup>(1)</sup>**

Address	Register	Description
10h	COMP_COEFF0_LSB	Bits [7:0] of the 1st and 5th FIR tap (C0 and C4)
11h	COMP_COEFF0_MSB	Bits [15:8] of the 1st and 5th FIR tap (C0 and C4)
12h	COMP_COEFF1_LSB	Bits [7:0] of the 2nd and 4th FIR tap (C1 and C3)
13h	COMP_COEFF1_MSB	Bits [15:8] of the 2nd and 4th FIR tap (C1 and C3)
14h	COMP_COEFF2_LSB	Bits [7:0] of the 3rd FIR tap (C2)
15h	COMP_COEFF2_MSB	Bits [15:8] of the 3rd FIR tap (C2)

(1) The filter must be phase linear to ensure the data keeps the correct stereo imaging so the second half of the FIR filter must be the reverse of the 1st half.



If the CUST\_COMP option in register 0Eh is not set the FIR filter will use its default values for a linear response from the DAC into the analog mixer, these values are:

DAC_OSR	C0, C4	C1, C3	C2
00	434	-2291	26984
01, 10, 11	61	-371	25699

If using 96 or 192kHz data then the custom compensation may be required to obtain flat frequency responses above 24kHz. The total power of any custom filter must not exceed that of the above examples or the filters within the DAC will clip. The coefficient must be programmed in 2's complement.

Typical Performance Characteristics

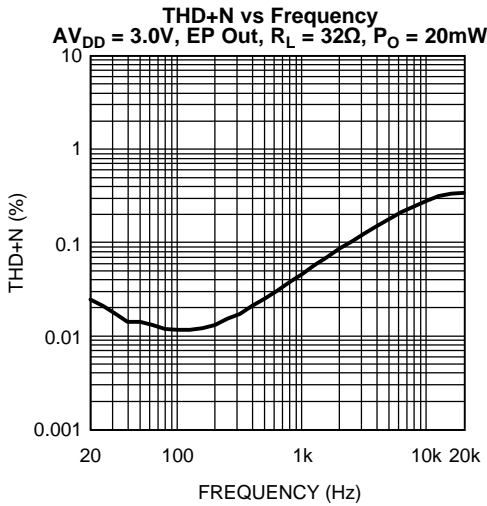


Figure 8.

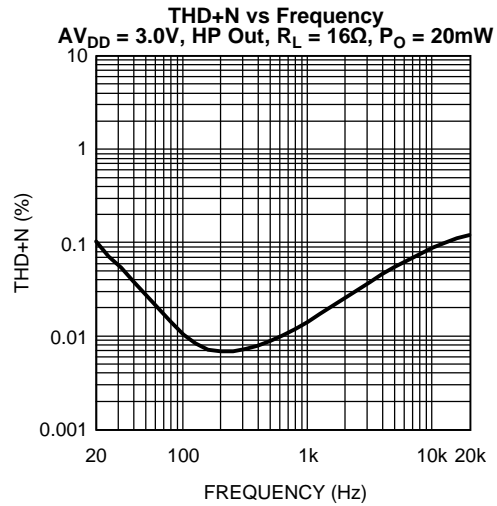


Figure 9.

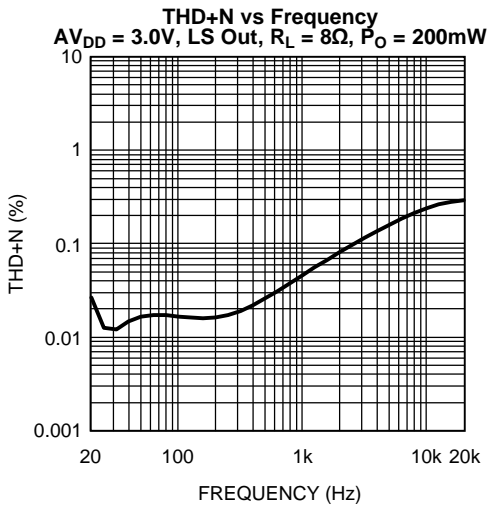


Figure 10.

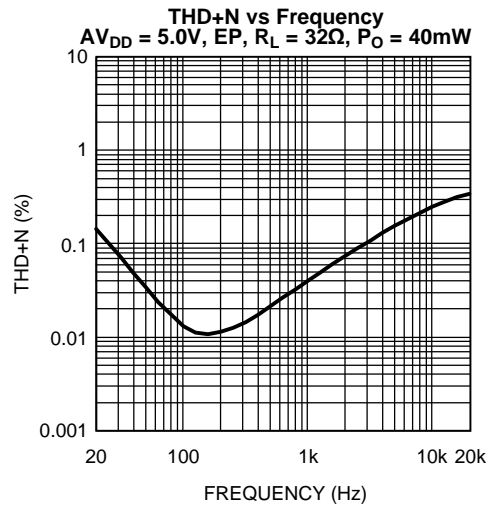


Figure 11.

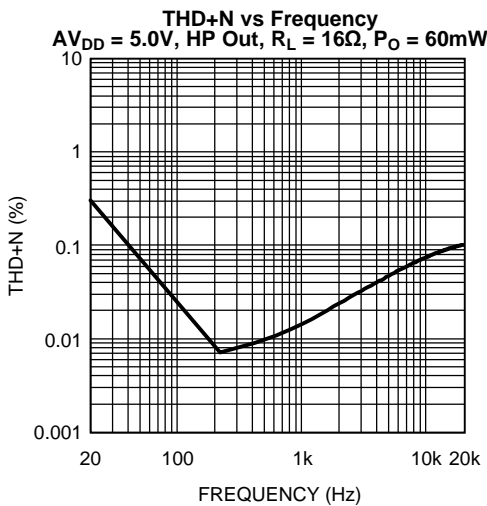


Figure 12.

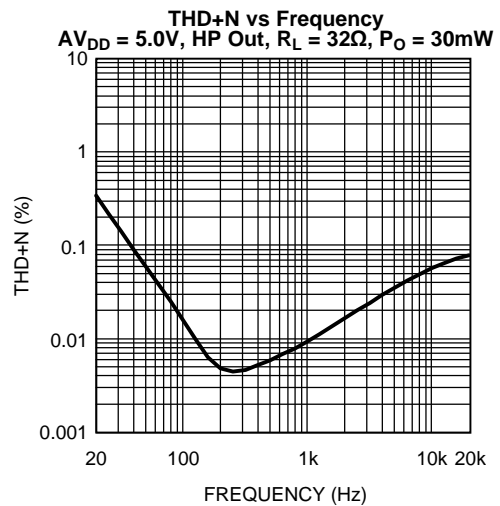


Figure 13.

**Typical Performance Characteristics (continued)**

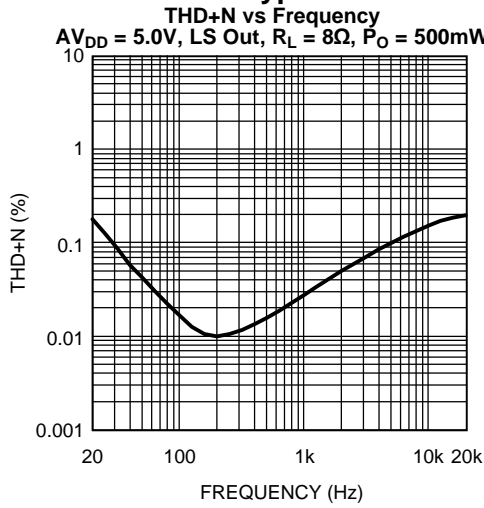


Figure 14.

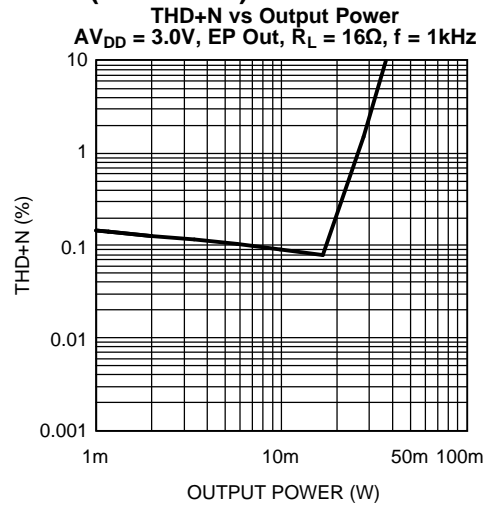


Figure 15.

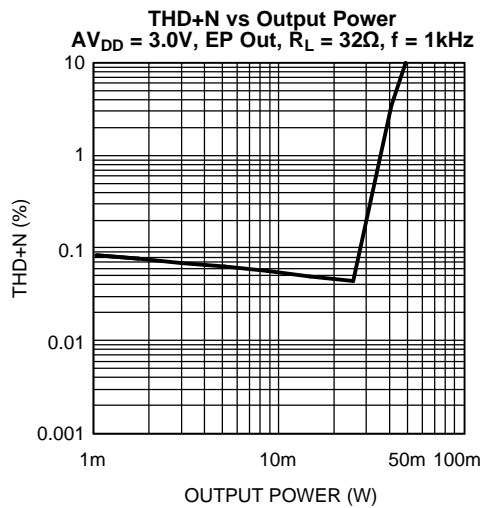


Figure 16.

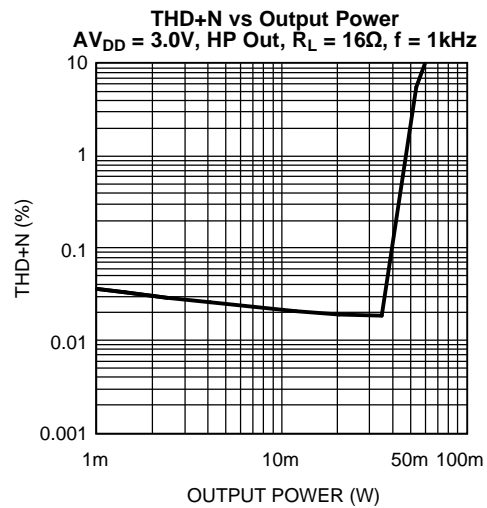


Figure 17.

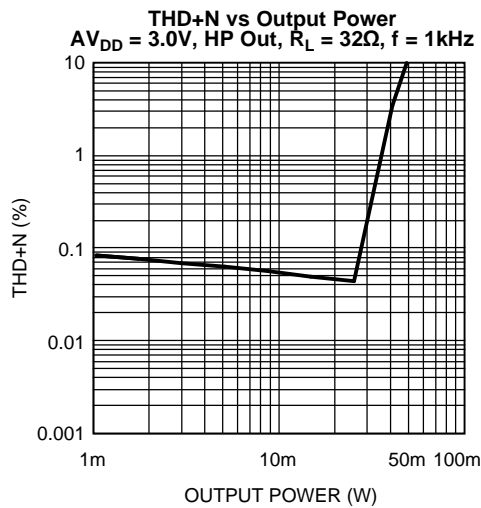


Figure 18.

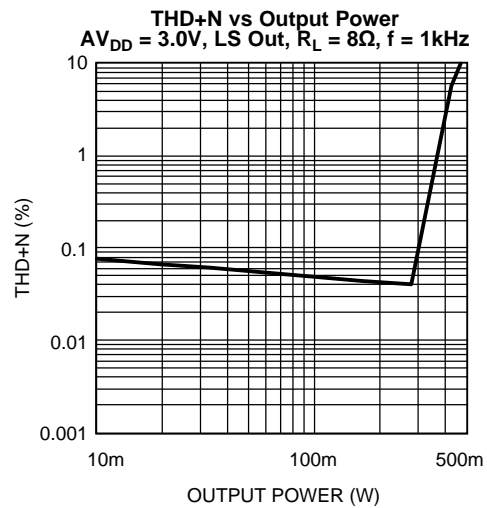


Figure 19.

Typical Performance Characteristics (continued)

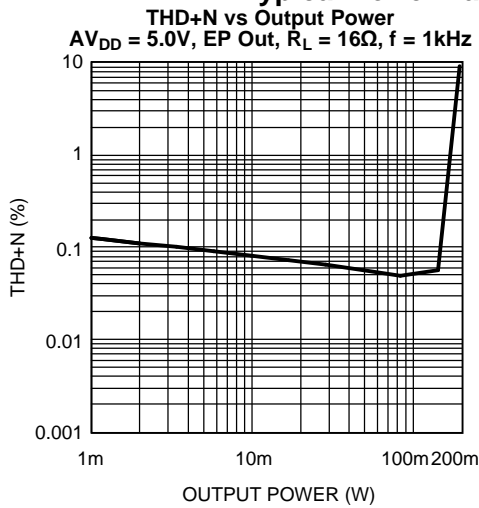


Figure 20.

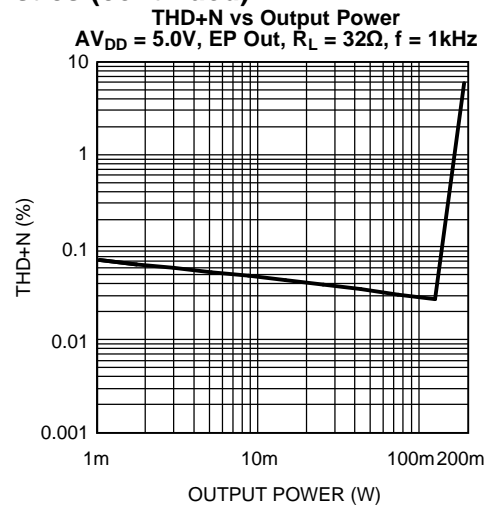


Figure 21.

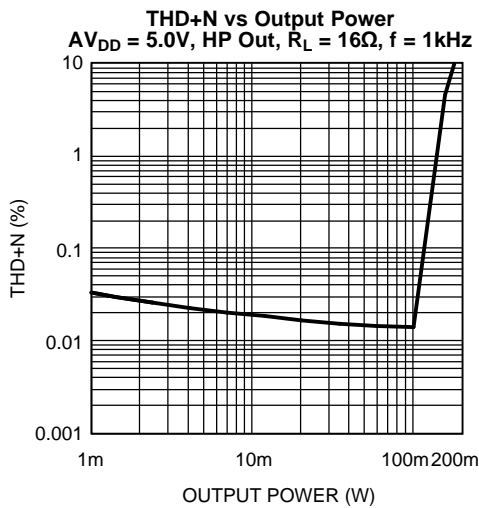


Figure 22.

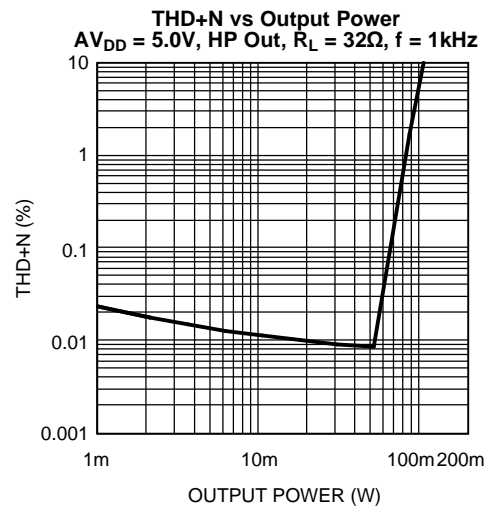


Figure 23.

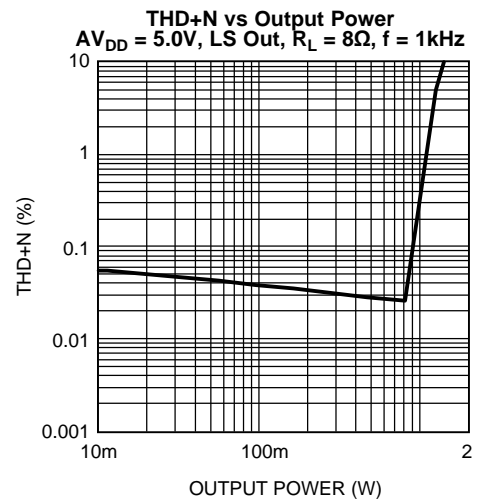


Figure 24.

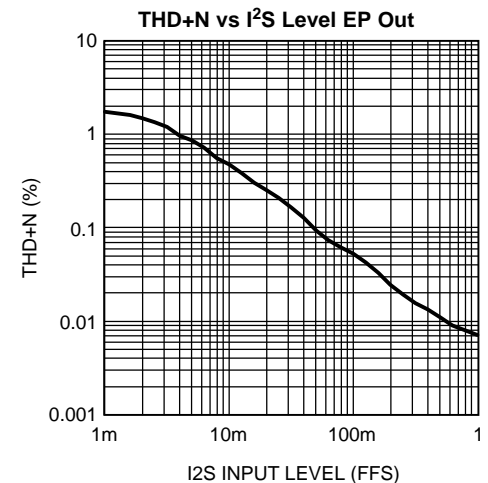


Figure 25.

**Typical Performance Characteristics (continued)**

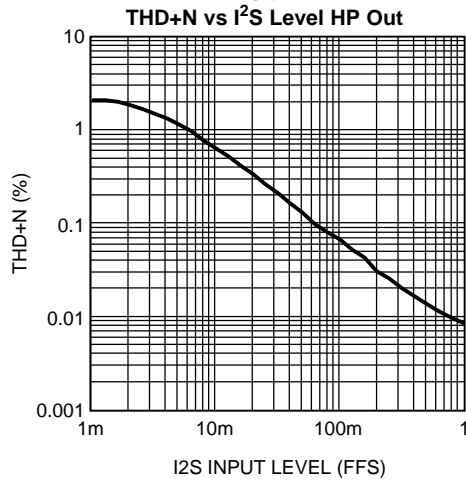


Figure 26.

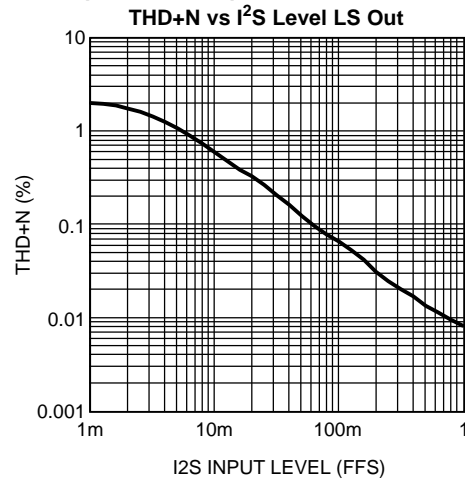


Figure 27.

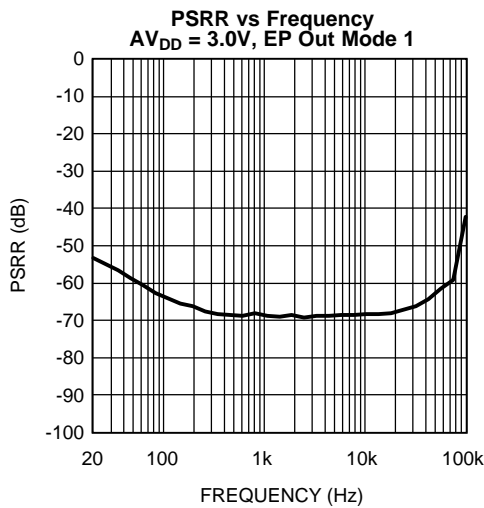


Figure 28.

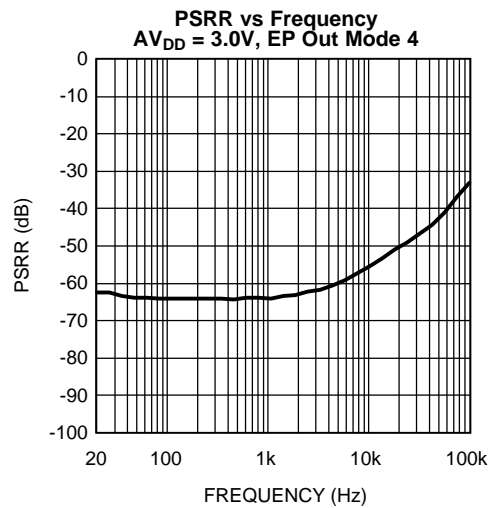


Figure 29.

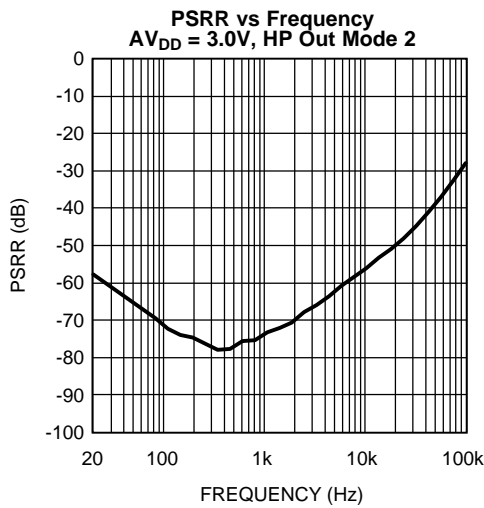


Figure 30.

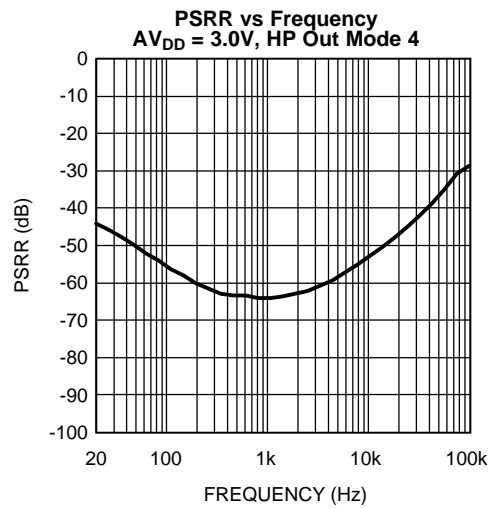


Figure 31.

Typical Performance Characteristics (continued)

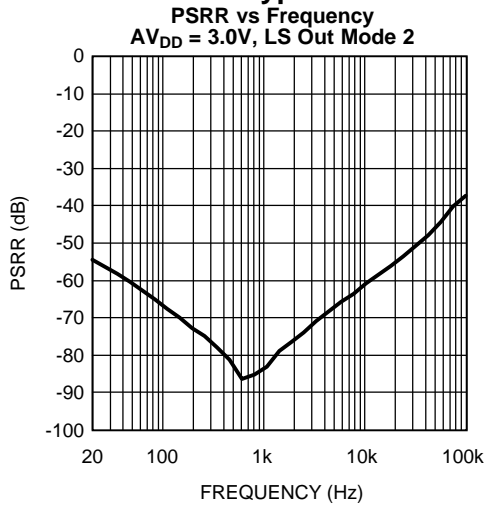


Figure 32.

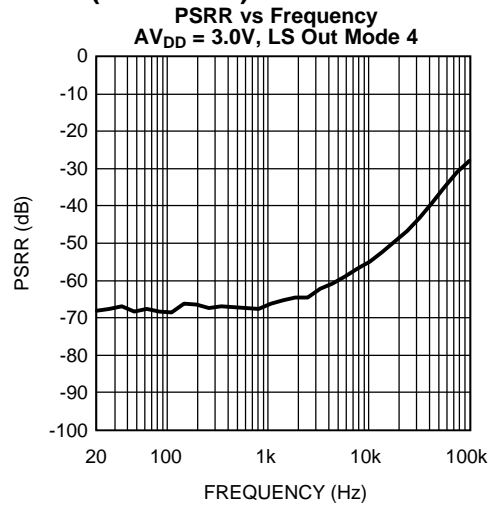


Figure 33.

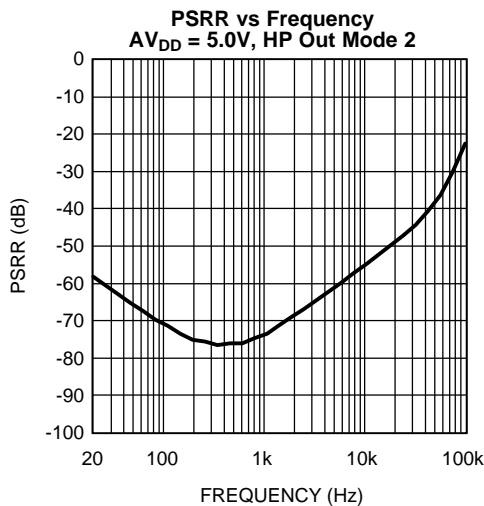


Figure 34.

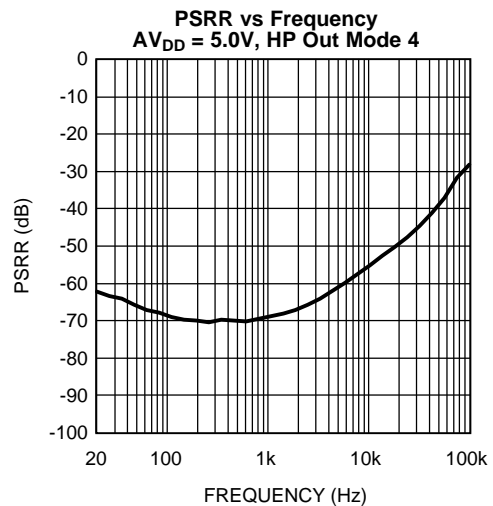


Figure 35.

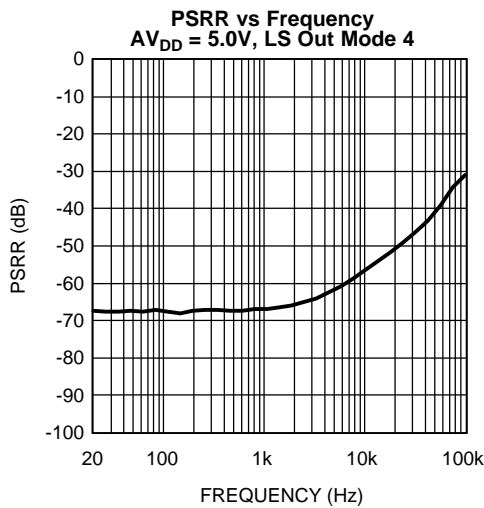


Figure 36.

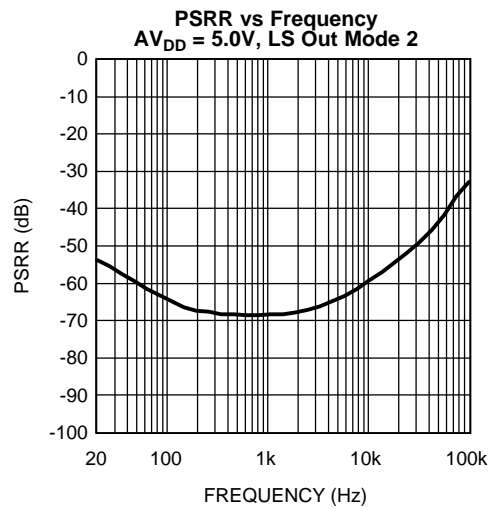


Figure 37.

**Typical Performance Characteristics (continued)**

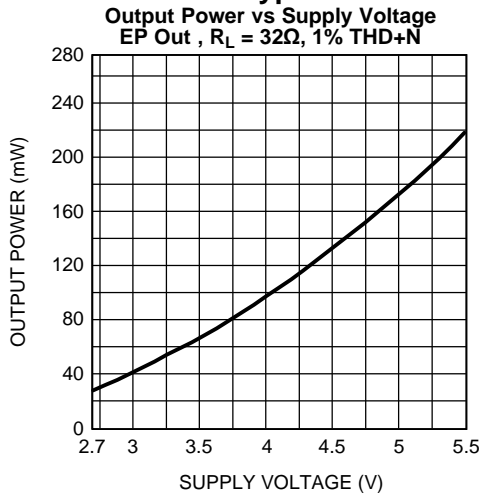


Figure 38.

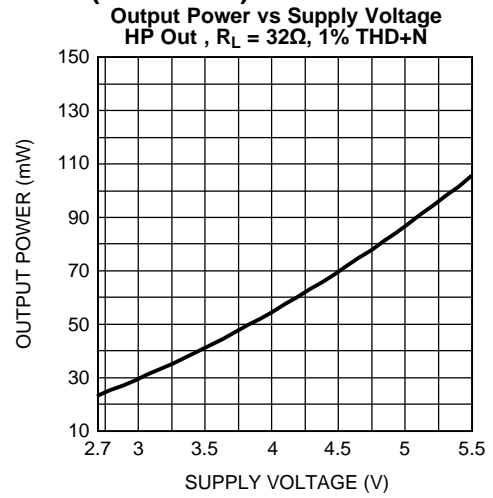


Figure 39.

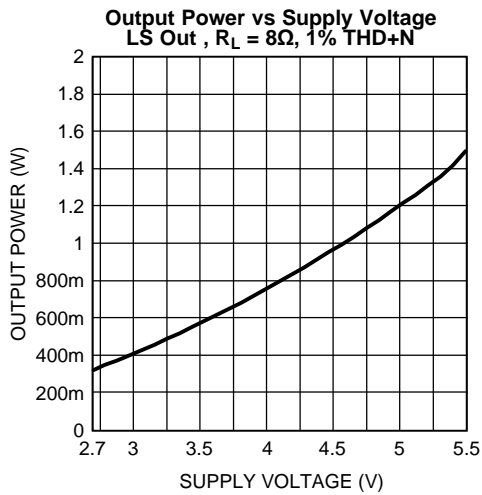


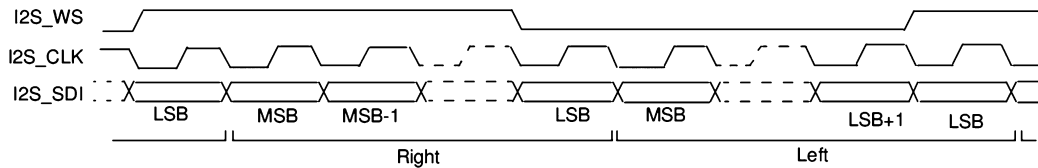
Figure 40.



## APPLICATION INFORMATION

### I<sup>2</sup>S

The LM49321 supports both master and slave I<sup>2</sup>S transmission at either 16 or 32 bits per word at clock rates up to 3.072MHz (48kHz stereo, 32bit). The basic format is shown below:



**Figure 41.**

### MONO ONLY SETTING

The LM49321 may be restricted to mono amplification only by setting MONO\_ONLY in Output Control register 0x01h to 1. This may save an additional 400µA from I<sub>DD</sub>.

### LM49321 DEMOBOARD OPERATION

#### BOARD LAYOUT

#### DIGITAL SUPPLIES

- JP14 — Digital Power DVDD
- JP10 — I/O Power IOVDD
- JP13 — PLL Supply PLLVDD
- JP16 — USB Board Supply BBVDD
- JP15 — I<sup>2</sup>CVDD

All supplies may be set independently. All digital ground is common. Jumpers may be used to connect all the digital supplies together.

- S9 – connects VDD\_PLL to VDD\_D
- S10 – connects VDD\_D to VDD\_IO
- S11 – connects VDD\_IO to VDD\_I2C
- S12 – connects VDD\_I2C to Analog VDD
- S17 – connects BB\_VDD to USB3.3V (from USB board)
- S19 – connects VDD\_D to USB3.3V (from USB board)
- S20 – connects VDD\_D to SPDIF receiver chip

#### ANALOG SUPPLY

- JP11 — Analog Supply
- S12 — connects Analog VDD with Digital VDD (I2C\_VDD)
- S16 — connects Analog Ground with Digital Ground
- S21 — connects Analog VDD to SPDIF receiver chip

## INPUTS

### Analog Inputs

JP2 — Mono Differential Input

JP6 — Left Input

JP7 — Right Input

### Digital Inputs

JP19 — Digital Interface

Pin 1 — MCLK

Pin 2 — I2S\_CLK

Pin 3 — I2S\_SDI

Pin 4 — I<sup>2</sup>S\_WS

JP20 — Toslink SPDIF Input

JP21 — Coaxial SPDIF Input

Coaxial and Toslink inputs may be toggled between by use of S25. Only one may be used at a time. Must be used in conjunction with on-board SPDIF receiver chip.

## OUTPUTS

JP5 — BTL Loudspeaker Output

JP1 — Left Headphone Output (Single-Ended or OCL)

JP3 — Right Headphone Output (Single-Ended or OCL)

P1 — Stereo Headphone Jack (Same as JP1, JP2, Single-Ended or OCL)

JP12 — Mono BTL Earpiece Output

## CONTROL INTERFACE

X1, X2 – USB Control Bus for I<sup>2</sup>C/SPI

X1

Pin 9 – Mode Select (SPI or I<sup>2</sup>C)

X2

Pin 1 – SDA

Pin 3 – SCL

Pin 15 – ADDR/END

Pin 14 – USB5V

Pin 16 – USB3.3V

Pin 16 – USB GND

## MISCELLANEOUS

### I<sup>2</sup>S BUS SELECT

S23, S24, S26, S27 – I<sup>2</sup>S Bus select. Toggles between on-board and external I<sup>2</sup>S (whether on-board SPDIF receiver is used). All jumpers must be set the same. Jumpers on top two pins selects external bus (JP19). Jumpers on bottom two pins selects on-board SPDIF receiver output.

## HEADPHONE OUTPUT CONFIGURATION

Jumpers S1, S2, S3, and S4 are used to configure the headphone outputs for either cap-coupled outputs or output capacitorless (OCL) mode in addition to the register control internal to the LM49321 for this feature. Jumpers S1 and S3 bypass the output DC blocking capacitors when OCL mode is required. S2 connects the center amplifier HPCOUT to the headphone ring when in OCL mode. S4 connects the center ring to GND when cap-coupled mode is desired. S4 must be removed for OCL mode to function properly. Jumper settings for each mode:

OCL

S1 = ON

S2 = ON

S3 = ON

S4 = OFF

Cap-Coupled

S1 = OFF

S2 = OFF

S3 = OFF

S4 = ON

## PLL FILTER CONFIGURATION

The LM49321 demo board comes with a simple filter setup by connecting jumpers S5 and S6. Removing these and connecting jumpers S7 and S8 will allow for an alternate PLL filter configuration to be used at R2 and C23.

## ON-BOARD SPDIF RECEIVER

The SPDIF receiver present on the LM49321 demo board allows quick demonstration of the capabilities of the LM49321 by using the common SPDIF output found on most CD/DVD players today. There are some limitations in its usage, as the receiver will not work with digital supplies of less than 3.0V and analog supplies of less than 4V. This means low analog supply voltage testing of the LM49321 must be done on the external digital bus.

The choice of using on-board or external digital bus is made using jumpers S23, S24, S26, and S27 as described above.

S25 selects whether the Toslink or Coaxial SPDIF input is used. The top two pins connects the toslink, the bottom two connect the coaxial input.

Power on the digital side is routed through S20 (connecting to the other digital supplies), while on the analog side it is interrupted by S21. Both jumpers must be in place for the receiver to function. The part is already configured for I<sup>2</sup>S standard outputs. Jumper S28 allows the DATA output to be pulled either high or low. Default is high (jumper on right two pins).

It may be necessary to quickly toggle S29 to reset the receiver and start it working upon initial power up. A quick short across S29 should clear this condition.

## LM49321 I<sup>2</sup>C/SPI INTERFACE SOFTWARE

Convenient graphical user interface software is available for demonstration purposes of the LM49321. It allows for either SPI or I<sup>2</sup>C control via either USB or parallel port connections to a Windows computer. Control options include all mode and output settings, volume controls, PLL and DAC setup, FIR setting and on-the-fly adjustment by an easy to use graphical interface. An advanced option is also present to allow direct, register-level commands. Software is available from [www.ti.com](http://www.ti.com) and is compatible with Windows operating systems of Windows 98 or more (with USB support) with the latest .NET updates from Microsoft.

Demonstration Board Schematic

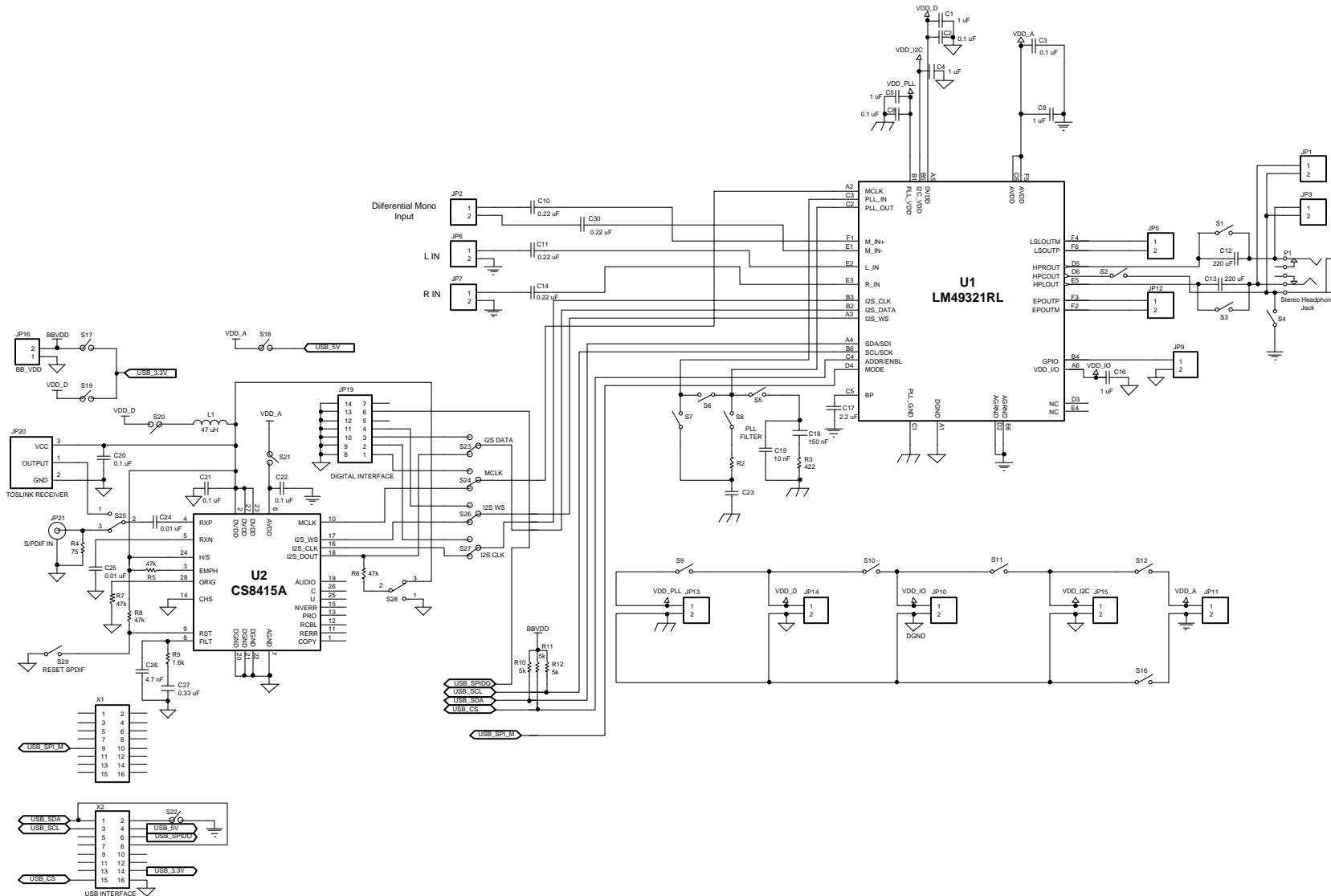


Figure 42. Complete Board Schematic

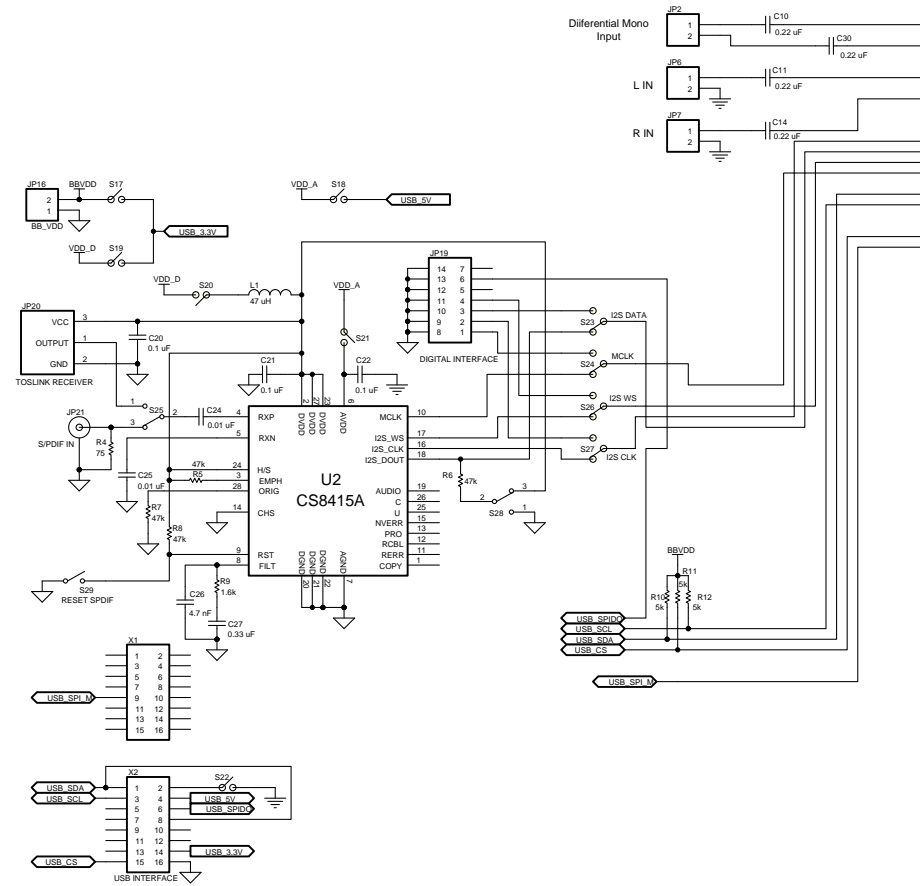


Figure 43. Enlarged Board Schematic Part 1 of 2

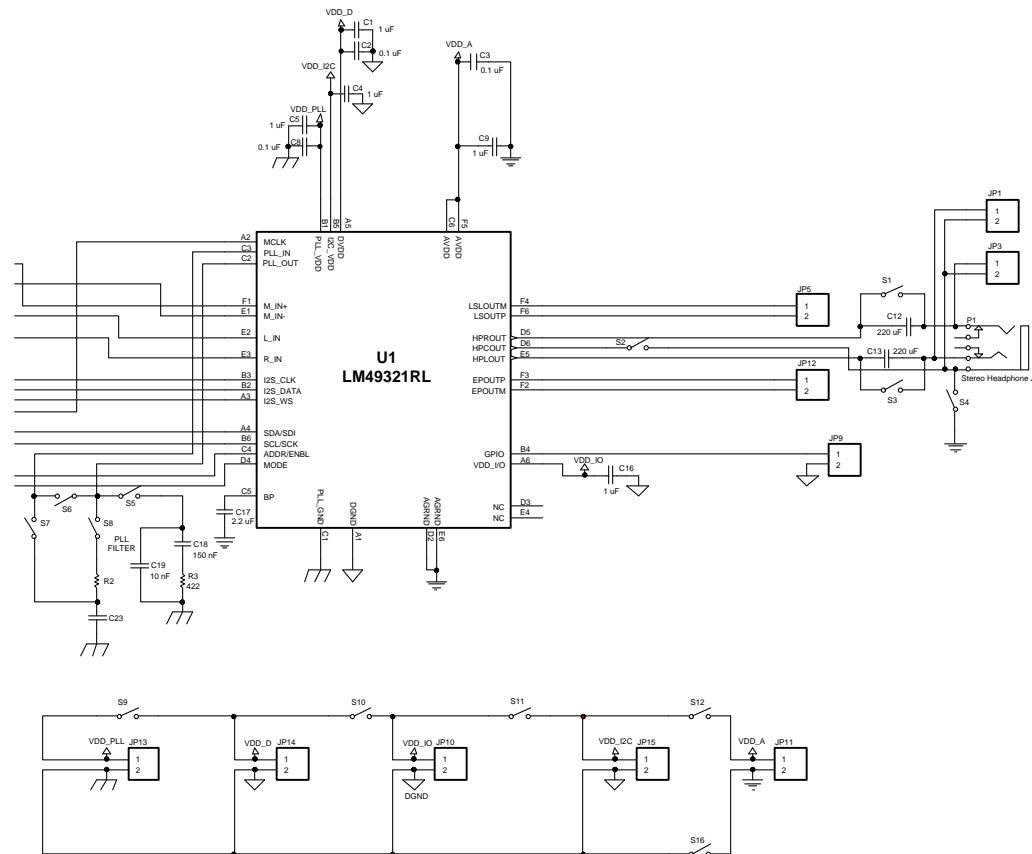


Figure 44. Enlarged Board Schematic Part 2 of 2

**Revision History**

<b>Rev</b>	<b>Date</b>	<b>Description</b>
1.0	09/10/08	Initial release.
1.01	09/23/08	Text edits.
1.02	08/31/09	Edited the package drawing and the top markings.
C	05/03/13	Changed layout of National Data Sheet to TI format.

**PACKAGING INFORMATION**

Orderable Device	Status (1)	Package Type	Package Drawing	Pins	Package Qty	Eco Plan (2)	Lead/Ball Finish (6)	MSL Peak Temp (3)	Op Temp (°C)	Device Marking (4/5)	Samples
LM49321RL/NOPB	ACTIVE	DSBGA	YPG	36	250	Green (RoHS & no Sb/Br)	SNAG	Level-1-260C-UNLIM	-40 to 85	GK9	Samples

(1) The marketing status values are defined as follows:

**ACTIVE:** Product device recommended for new designs.

**LIFEBUY:** TI has announced that the device will be discontinued, and a lifetime-buy period is in effect.

**NRND:** Not recommended for new designs. Device is in production to support existing customers, but TI does not recommend using this part in a new design.

**PREVIEW:** Device has been announced but is not in production. Samples may or may not be available.

**OBSOLETE:** TI has discontinued the production of the device.

(2) Eco Plan - The planned eco-friendly classification: Pb-Free (RoHS), Pb-Free (RoHS Exempt), or Green (RoHS & no Sb/Br) - please check <http://www.ti.com/productcontent> for the latest availability information and additional product content details.

**TBD:** The Pb-Free/Green conversion plan has not been defined.

**Pb-Free (RoHS):** TI's terms "Lead-Free" or "Pb-Free" mean semiconductor products that are compatible with the current RoHS requirements for all 6 substances, including the requirement that lead not exceed 0.1% by weight in homogeneous materials. Where designed to be soldered at high temperatures, TI Pb-Free products are suitable for use in specified lead-free processes.

**Pb-Free (RoHS Exempt):** This component has a RoHS exemption for either 1) lead-based flip-chip solder bumps used between the die and package, or 2) lead-based die adhesive used between the die and leadframe. The component is otherwise considered Pb-Free (RoHS compatible) as defined above.

**Green (RoHS & no Sb/Br):** TI defines "Green" to mean Pb-Free (RoHS compatible), and free of Bromine (Br) and Antimony (Sb) based flame retardants (Br or Sb do not exceed 0.1% by weight in homogeneous material)

(3) MSL, Peak Temp. - The Moisture Sensitivity Level rating according to the JEDEC industry standard classifications, and peak solder temperature.

(4) There may be additional marking, which relates to the logo, the lot trace code information, or the environmental category on the device.

(5) Multiple Device Markings will be inside parentheses. Only one Device Marking contained in parentheses and separated by a "~" will appear on a device. If a line is indented then it is a continuation of the previous line and the two combined represent the entire Device Marking for that device.

(6) Lead/Ball Finish - Orderable Devices may have multiple material finish options. Finish options are separated by a vertical ruled line. Lead/Ball Finish values may wrap to two lines if the finish value exceeds the maximum column width.

**Important Information and Disclaimer:** The information provided on this page represents TI's knowledge and belief as of the date that it is provided. TI bases its knowledge and belief on information provided by third parties, and makes no representation or warranty as to the accuracy of such information. Efforts are underway to better integrate information from third parties. TI has taken and continues to take reasonable steps to provide representative and accurate information but may not have conducted destructive testing or chemical analysis on incoming materials and chemicals. TI and TI suppliers consider certain information to be proprietary, and thus CAS numbers and other limited information may not be available for release.

In no event shall TI's liability arising out of such information exceed the total purchase price of the TI part(s) at issue in this document sold by TI to Customer on an annual basis.





## TAPE AND REEL INFORMATION



### QUADRANT ASSIGNMENTS FOR PIN 1 ORIENTATION IN TAPE



\*All dimensions are nominal

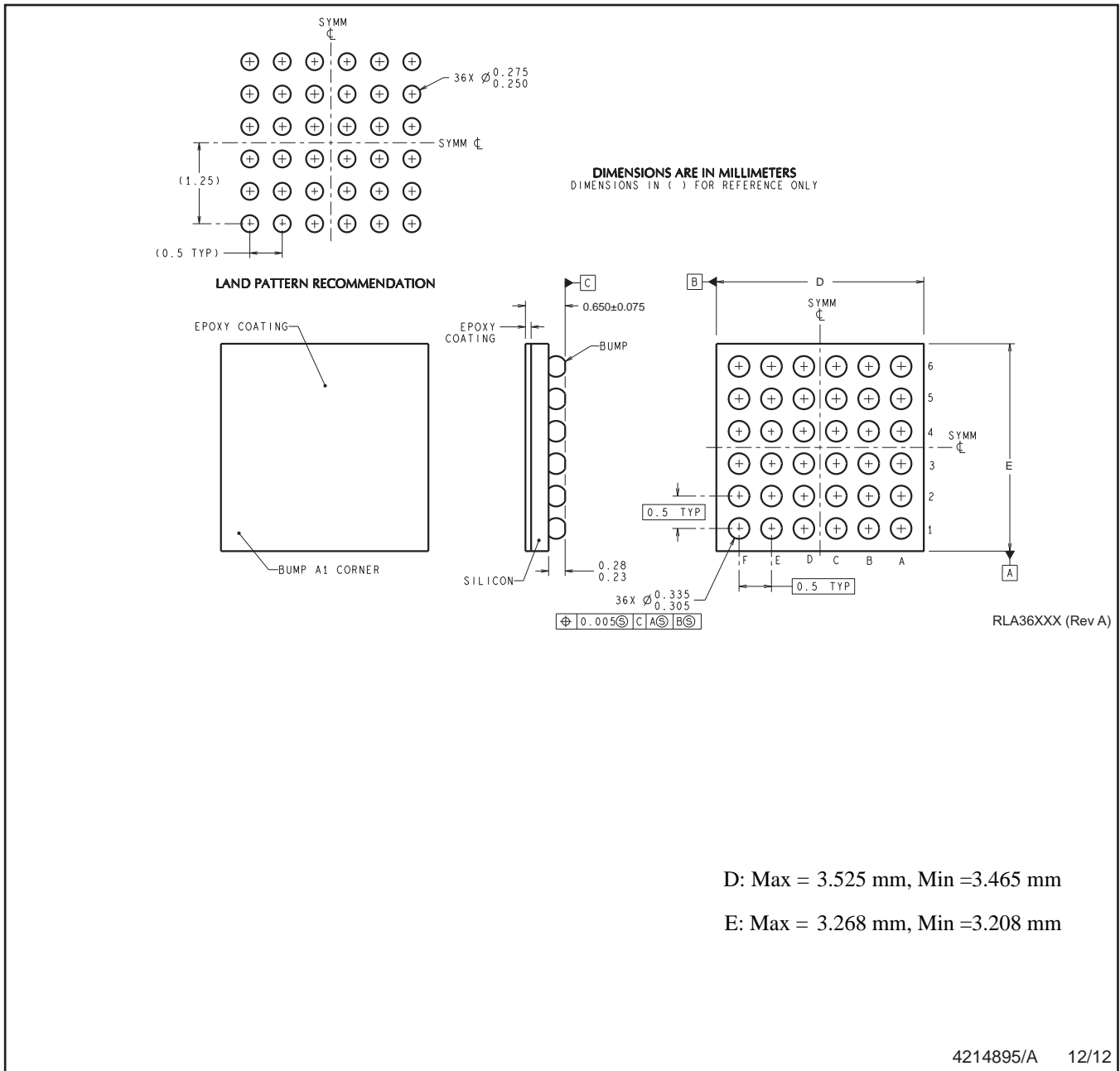
Device	Package Type	Package Drawing	Pins	SPQ	Reel Diameter (mm)	Reel Width W1 (mm)	A0 (mm)	B0 (mm)	K0 (mm)	P1 (mm)	W (mm)	Pin1 Quadrant
LM49321RL/NOPB	DSBGA	YPG	36	250	178.0	12.4	3.43	3.59	0.76	8.0	12.0	Q1

**TAPE AND REEL BOX DIMENSIONS**


\*All dimensions are nominal

Device	Package Type	Package Drawing	Pins	SPQ	Length (mm)	Width (mm)	Height (mm)
LM49321RL/NOPB	DSBGA	YPG	36	250	210.0	185.0	35.0

YPG0036



4214895/A 12/12

NOTES: A. All linear dimensions are in millimeters. Dimensioning and tolerancing per ASME Y14.5M-1994.  
 B. This drawing is subject to change without notice.

## IMPORTANT NOTICE

Texas Instruments Incorporated and its subsidiaries (TI) reserve the right to make corrections, enhancements, improvements and other changes to its semiconductor products and services per JESD46, latest issue, and to discontinue any product or service per JESD48, latest issue. Buyers should obtain the latest relevant information before placing orders and should verify that such information is current and complete. All semiconductor products (also referred to herein as "components") are sold subject to TI's terms and conditions of sale supplied at the time of order acknowledgment.

TI warrants performance of its components to the specifications applicable at the time of sale, in accordance with the warranty in TI's terms and conditions of sale of semiconductor products. Testing and other quality control techniques are used to the extent TI deems necessary to support this warranty. Except where mandated by applicable law, testing of all parameters of each component is not necessarily performed.

TI assumes no liability for applications assistance or the design of Buyers' products. Buyers are responsible for their products and applications using TI components. To minimize the risks associated with Buyers' products and applications, Buyers should provide adequate design and operating safeguards.

TI does not warrant or represent that any license, either express or implied, is granted under any patent right, copyright, mask work right, or other intellectual property right relating to any combination, machine, or process in which TI components or services are used. Information published by TI regarding third-party products or services does not constitute a license to use such products or services or a warranty or endorsement thereof. Use of such information may require a license from a third party under the patents or other intellectual property of the third party, or a license from TI under the patents or other intellectual property of TI.

Reproduction of significant portions of TI information in TI data books or data sheets is permissible only if reproduction is without alteration and is accompanied by all associated warranties, conditions, limitations, and notices. TI is not responsible or liable for such altered documentation. Information of third parties may be subject to additional restrictions.

Resale of TI components or services with statements different from or beyond the parameters stated by TI for that component or service voids all express and any implied warranties for the associated TI component or service and is an unfair and deceptive business practice. TI is not responsible or liable for any such statements.

Buyer acknowledges and agrees that it is solely responsible for compliance with all legal, regulatory and safety-related requirements concerning its products, and any use of TI components in its applications, notwithstanding any applications-related information or support that may be provided by TI. Buyer represents and agrees that it has all the necessary expertise to create and implement safeguards which anticipate dangerous consequences of failures, monitor failures and their consequences, lessen the likelihood of failures that might cause harm and take appropriate remedial actions. Buyer will fully indemnify TI and its representatives against any damages arising out of the use of any TI components in safety-critical applications.

In some cases, TI components may be promoted specifically to facilitate safety-related applications. With such components, TI's goal is to help enable customers to design and create their own end-product solutions that meet applicable functional safety standards and requirements. Nonetheless, such components are subject to these terms.

No TI components are authorized for use in FDA Class III (or similar life-critical medical equipment) unless authorized officers of the parties have executed a special agreement specifically governing such use.

Only those TI components which TI has specifically designated as military grade or "enhanced plastic" are designed and intended for use in military/aerospace applications or environments. Buyer acknowledges and agrees that any military or aerospace use of TI components which have **not** been so designated is solely at the Buyer's risk, and that Buyer is solely responsible for compliance with all legal and regulatory requirements in connection with such use.

TI has specifically designated certain components as meeting ISO/TS16949 requirements, mainly for automotive use. In any case of use of non-designated products, TI will not be responsible for any failure to meet ISO/TS16949.

### Products

Audio	<a href="http://www.ti.com/audio">www.ti.com/audio</a>
Amplifiers	<a href="http://amplifier.ti.com">amplifier.ti.com</a>
Data Converters	<a href="http://dataconverter.ti.com">dataconverter.ti.com</a>
DLP® Products	<a href="http://www.dlp.com">www.dlp.com</a>
DSP	<a href="http://dsp.ti.com">dsp.ti.com</a>
Clocks and Timers	<a href="http://www.ti.com/clocks">www.ti.com/clocks</a>
Interface	<a href="http://interface.ti.com">interface.ti.com</a>
Logic	<a href="http://logic.ti.com">logic.ti.com</a>
Power Mgmt	<a href="http://power.ti.com">power.ti.com</a>
Microcontrollers	<a href="http://microcontroller.ti.com">microcontroller.ti.com</a>
RFID	<a href="http://www.ti-rfid.com">www.ti-rfid.com</a>
OMAP Applications Processors	<a href="http://www.ti.com/omap">www.ti.com/omap</a>
Wireless Connectivity	<a href="http://www.ti.com/wirelessconnectivity">www.ti.com/wirelessconnectivity</a>

### Applications

Automotive and Transportation	<a href="http://www.ti.com/automotive">www.ti.com/automotive</a>
Communications and Telecom	<a href="http://www.ti.com/communications">www.ti.com/communications</a>
Computers and Peripherals	<a href="http://www.ti.com/computers">www.ti.com/computers</a>
Consumer Electronics	<a href="http://www.ti.com/consumer-apps">www.ti.com/consumer-apps</a>
Energy and Lighting	<a href="http://www.ti.com/energy">www.ti.com/energy</a>
Industrial	<a href="http://www.ti.com/industrial">www.ti.com/industrial</a>
Medical	<a href="http://www.ti.com/medical">www.ti.com/medical</a>
Security	<a href="http://www.ti.com/security">www.ti.com/security</a>
Space, Avionics and Defense	<a href="http://www.ti.com/space-avionics-defense">www.ti.com/space-avionics-defense</a>
Video and Imaging	<a href="http://www.ti.com/video">www.ti.com/video</a>

### TI E2E Community

[e2e.ti.com](http://e2e.ti.com)