

# LMV34x Rail-to-Rail Output CMOS Operational Amplifiers With Shutdown

## 1 Features

- 2.7-V and 5-V Performance
- Rail-to-Rail Output Swing
- Input Bias Current: 1 pA (Typical)
- Input Offset Voltage: 0.25 mV (Typical)
- Low Supply Current: 100  $\mu$ A (Typical)
- Low Shutdown Current: 45 pA (Typical)
- Gain Bandwidth of 1 MHz (Typical)
- Slew Rate: 1 V/ $\mu$ s (Typical)
- Turnon Time From Shutdown: 5  $\mu$ s (Typical)
- Input Referred Voltage Noise (at 10 kHz): 20 nV/ $\sqrt{\text{Hz}}$
- ESD Protection Exceeds JESD 22
  - 2000-V Human-Body Model (HBM)
  - 750-V Charged-device model (CDM)

## 2 Applications

- Cordless and Cellular Phones
- Consumer Electronics (Laptops, PDAs)
- Audio Preamplifiers for Voice
- Portable, Battery-Powered Electronic Equipment
- Supply-Current Monitoring
- Battery Monitoring
- Buffers
- Filters
- Drivers

## 3 Description

The LMV34x devices are single, dual, and quad CMOS operational amplifiers, respectively, with low voltage, low power, and rail-to-rail output swing capabilities. The PMOS input stage offers an ultra-low input bias current of 1 pA (typical) and an offset voltage of 0.25 mV (typical). The single-supply amplifier is designed specifically for low-voltage (2.7 V to 5 V) operation, with a wide common-mode input voltage range that typically extends from  $-0.2$  V to 0.8 V from the positive supply rail. The LMV341 (single) also offers a shutdown (SHDN) pin that can be used to disable the device. In shutdown mode, the supply current is reduced to 33 nA (typical). Additional features of the family are a 20-nV/ $\sqrt{\text{Hz}}$  voltage noise at 10 kHz, 1-MHz unity-gain bandwidth, 1-V/ $\mu$ s slew rate, and 100- $\mu$ A current consumption per channel.

Offered in both the SOT-23 and smaller SC70 packages, the LMV341 is suitable for the most space-constraint applications. The LMV342 dual device is offered in the standard SOIC and VSSOP packages. An extended industrial temperature range from  $-40^{\circ}\text{C}$  to  $125^{\circ}\text{C}$  makes these devices suitable in a wide variety of commercial and industrial environments.

### Device Information<sup>(1)</sup>

| PART NUMBER | PACKAGE    | BODY SIZE (NOM)          |
|-------------|------------|--------------------------|
| LMV341IDCK  | SC70 (6)   | 2.00 mm $\times$ 1.25 mm |
| LMV341IDBV  | SOT-23 (6) | 2.90 mm $\times$ 1.60 mm |
| LMV342ID    | SOIC (8)   | 4.90 mm $\times$ 3.91 mm |
| LMV342IDGK  | VSSOP (8)  | 3.00 mm $\times$ 3.00 mm |
| LMV344ID    | SOIC (14)  | 8.65 mm $\times$ 3.91 mm |
| LMV344IPW   | TSSOP (14) | 5.00 mm $\times$ 4.40 mm |

(1) For all available packages, see the orderable addendum at the end of the data sheet.

### Sample-and-Hold Circuit

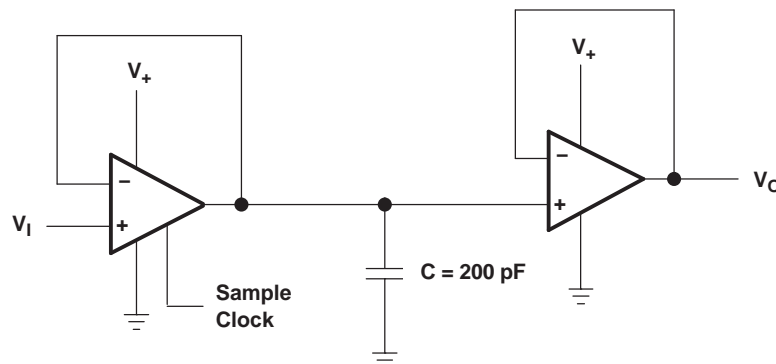

## Table of Contents

|  |   |
|--|---|
| <b>1 Features</b> ..... 1<br><b>2 Applications</b> ..... 1<br><b>3 Description</b> ..... 1<br><b>4 Revision History</b> ..... 2<br><b>5 Pin Configuration and Functions</b> ..... 3<br><b>6 Specifications</b> ..... 4<br>6.1 Absolute Maximum Ratings ..... 4<br>6.2 ESD Ratings ..... 5<br>6.3 Recommended Operating Conditions ..... 5<br>6.4 Thermal Information ..... 5<br>6.5 Electrical Characteristics: $V_+ = 2.7\text{ V}$ ..... 5<br>6.6 Electrical Characteristics: $V_+ = 5\text{ V}$ ..... 6<br>6.7 Shutdown Characteristics: $V_+ = 2.7\text{ V}$ ..... 7<br>6.8 Shutdown Characteristics: $V_+ = 5\text{ V}$ ..... 7<br>6.9 Typical Characteristics ..... 8<br><b>7 Detailed Description</b> ..... 14<br>7.1 Overview ..... 14 | 7.2 Functional Block Diagram ..... 14<br>7.3 Feature Description ..... 14<br>7.4 Device Functional Modes ..... 14<br><b>8 Application and Implementation</b> ..... 15<br>8.1 Application Information ..... 15<br>8.2 Typical Application ..... 15<br><b>9 Power Supply Recommendations</b> ..... 16<br><b>10 Layout</b> ..... 17<br>10.1 Layout Guidelines ..... 17<br>10.2 Layout Examples ..... 17<br><b>11 Device and Documentation Support</b> ..... 18<br>11.1 Related Links ..... 18<br>11.2 Community Resources ..... 18<br>11.3 Trademarks ..... 18<br>11.4 Electrostatic Discharge Caution ..... 18<br>11.5 Glossary ..... 18<br><b>12 Mechanical, Packaging, and Orderable Information</b> ..... 18 |
|--|---|

## 4 Revision History

NOTE: Page numbers for previous revisions may differ from page numbers in the current version.

| Changes from Revision H (June 2012) to Revision I   | Page |
|---|------|
| <ul style="list-style-type: none"> <li>• Added <i>ESD Ratings</i> table, <i>Feature Description</i> section, <i>Device Functional Modes</i>, <i>Application and Implementation</i> section, <i>Power Supply Recommendations</i> section, <i>Layout</i> section, <i>Device and Documentation Support</i> section, and <i>Mechanical, Packaging, and Orderable Information</i> section. ....</li> </ul> | 1    |
| <ul style="list-style-type: none"> <li>• Removed <i>Ordering Information</i> table .....</li> </ul>   | 1    |

## 5 Pin Configuration and Functions

**DBV or DCK Package  
6-Pin SOT-23 or SC70  
Top View**

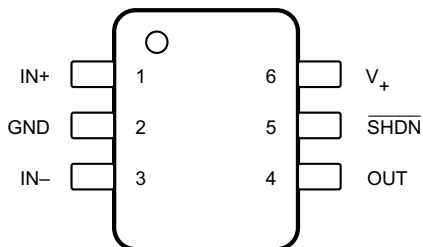

**Pin Functions: LMV341**

| PIN  |              | I/O | DESCRIPTION                     |
|------|--------------|-----|---------------------------------|
| NAME | SOT-23, SC70 |     |                                 |
| IN+  | 1            | I   | Noninverting input on channel 1 |
| IN-  | 3            | I   | Inverting input on channel 1    |
| OUT  | 4            | O   | Output on channel 1             |
| GND  | 2            | —   | Ground                          |
| SHDN | 5            | I   | Shutdown active low             |
| V+   | 6            | —   | Positive power supply           |

**D or DGK Package  
8-Pin SOIC or VSSOP  
Top View**

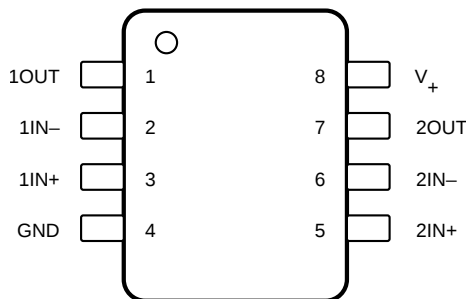

**Pin Functions: LMV342**

| PIN  |             | I/O | DESCRIPTION                     |
|------|-------------|-----|---------------------------------|
| NAME | SOIC, VSSOP |     |                                 |
| 1IN+ | 3           | I   | Noninverting input on channel 1 |
| 1IN- | 2           | I   | Inverting input on channel 1    |
| 1OUT | 1           | O   | Output on channel 1             |
| 2IN+ | 5           | I   | Noninverting input on channel 2 |
| 2IN- | 6           | I   | Inverting input on channel 2    |
| 2OUT | 7           | O   | Output on channel 2             |
| GND  | 4           | —   | Ground                          |
| V+   | 8           | —   | Positive power supply           |

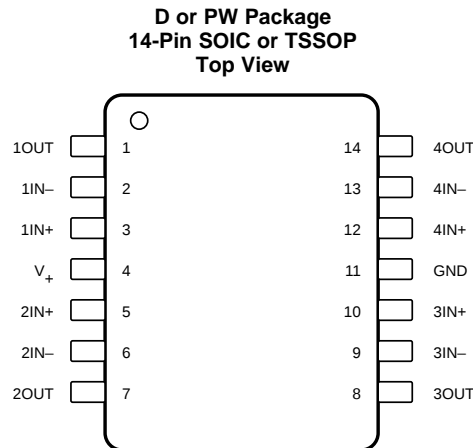
**Pin Functions: LMV344**

| PIN            |             | I/O | DESCRIPTION                     |
|----------------|-------------|-----|---------------------------------|
| NAME           | SOIC, TSSOP |     |                                 |
| 1IN+           | 3           | I   | Noninverting input on channel 1 |
| 1IN–           | 2           | I   | Inverting input on channel 1    |
| 1OUT           | 1           | O   | Output on channel 1             |
| 2IN+           | 5           | I   | Noninverting input on channel 2 |
| 2IN–           | 6           | I   | Inverting input on channel 2    |
| 2OUT           | 7           | O   | Output on channel 2             |
| 3IN+           | 10          | I   | Noninverting input on channel 3 |
| 3IN–           | 9           | I   | Inverting input on channel 3    |
| 3OUT           | 8           | O   | Output on channel 3             |
| 4IN+           | 12          | I   | Noninverting input on channel 4 |
| 4IN–           | 13          | I   | Inverting input on channel 4    |
| 4OUT           | 14          | O   | Output on channel 4             |
| GND            | 11          | —   | Ground                          |
| V <sub>+</sub> | 4           | —   | Positive power supply           |

## 6 Specifications

### 6.1 Absolute Maximum Ratings

over operating free-air temperature range (unless otherwise noted)<sup>(1)</sup>

|                  |   | MIN  | MAX                   | UNIT |
|------------------|---|------|-----------------------|------|
| V <sub>+</sub>   | Supply voltage <sup>(2)</sup>             | –0.3 | 5.5                   | V    |
| V <sub>ID</sub>  | Differential input voltage <sup>(3)</sup> |      | ±5.5                  | V    |
| V <sub>I</sub>   | Input voltage (either input)              | –0.3 | 5.5                   | V    |
| V <sub>O</sub>   | Output voltage                            | –0.3 | V <sub>CC</sub> + 0.3 | V    |
| T <sub>J</sub>   | Operating virtual junction temperature    |      | 150                   | °C   |
| T <sub>stg</sub> | Storage temperature                       | –65  | 150                   | °C   |

- (1) Stresses beyond those listed under *Absolute Maximum Ratings* may cause permanent damage to the device. These are stress ratings only, which do not imply functional operation of the device at these or any other conditions beyond those indicated under *Recommended Operating Conditions*. Exposure to absolute-maximum-rated conditions for extended periods may affect device reliability.
- (2) All voltage values (except differential voltages) are with respect to the network GND.
- (3) Differential voltages are at IN+ with respect to IN–.

## 6.2 ESD Ratings

|             |                         | VALUE  | UNIT  |
|-------------|-------------------------|--|-------|
| $V_{(ESD)}$ | Electrostatic discharge | Human-body model (HBM), per ANSI/ESDA/JEDEC JS-001 <sup>(1)</sup>              | ±2000 |
|             |                         | Charged-device model (CDM), per JEDEC specification JESD22-C101 <sup>(2)</sup> | ±750  |

(1) JEDEC document JEP155 states that 500-V HBM allows safe manufacturing with a standard ESD control process.

(2) JEDEC document JEP157 states that 250-V CDM allows safe manufacturing with a standard ESD control process.

## 6.3 Recommended Operating Conditions

|       |  | MIN | MAX | UNIT |
|-------|--|-----|-----|------|
| $V_+$ | Supply voltage (single-supply operation) | 2.5 | 5.5 | V    |
| $T_A$ | Operating free-air temperature           | −40 | 125 | °C   |

## 6.4 Thermal Information

| THERMAL METRIC <sup>(1)</sup> |  | LMV342   | LMV344  | LMV341       |            | LMV342      | LMV344     | UNIT |
|-------------------------------|--|----------|---------|--------------|------------|-------------|------------|------|
|                               |  | D (SOIC) |         | DBV (SOT-23) | DCK (SC70) | DGK (VSSOP) | PW (TSSOP) |      |
|                               |  | 8 PINS   | 14 PINS | 6 PINS       | 6 PINS     | 8 PINS      | 14 PINS    |      |
| $R_{\theta JA}$               | Junction-to-ambient thermal resistance <sup>(2)</sup> <sup>(3)</sup> | 123.9    | 88.7    | 193.4        | 196.8      | 192.3       | 118        | °C/W |
| $R_{\theta JC(top)}$          | Junction-to-case (top) thermal resistance                            | 70.2     | 49      | 145.6        | 82.4       | 78.2        | 46.9       | °C/W |
| $R_{\theta JB}$               | Junction-to-board thermal resistance                                 | 64.1     | 43      | 44.1         | 95.2       | 112.6       | 59.7       | °C/W |
| $\Psi_{JT}$                   | Junction-to-top characterization parameter                           | 25       | 16.9    | 34.1         | 1.8        | 15.2        | 5.1        | °C/W |
| $\Psi_{JB}$                   | Junction-to-board characterization parameter                         | 63.6     | 42.7    | 43.4         | 93.2       | 111.2       | 59.1       | °C/W |

(1) For more information about traditional and new thermal metrics, see the *Semiconductor and IC Package Thermal Metrics* application report, [SPRA953](#).

(2) Maximum power dissipation is a function of  $T_J(max)$ ,  $R_{\theta JA}$ , and  $T_A$ . The maximum allowable power dissipation at any allowable ambient temperature is  $P_D = (T_J(max) - T_A)/R_{\theta JA}$ . Operating at the absolute maximum  $T_J$  of 150°C can affect reliability.

(3) The package thermal impedance is calculated in accordance with JESD 51-7.

## 6.5 Electrical Characteristics: $V_+ = 2.7$ V

$V_+ = 2.7$  V, GND = 0 V,  $V_{IC} = V_O = V_+/2$ ,  $R_L > 1$  M $\Omega$  (unless otherwise noted)

| PARAMETER      |   | TEST CONDITIONS                 | $T_A$          | MIN | TYP <sup>(1)</sup> | MAX | UNIT             |
|----------------|---|---------------------------------|----------------|-----|--------------------|-----|------------------|
| $V_{IO}$       | Input offset voltage                                    |                                 | 25°C           |     | 0.25               | 4   | mV               |
|                |   |                                 | Full range     |     |                    | 4.5 |                  |
| $\alpha_{VIO}$ | Average temperature coefficient of input offset voltage |                                 | Full range     |     | 1.7                |     | $\mu V/^\circ C$ |
| $I_{IB}$       | Input bias current                                      |                                 | 25°C           |     | 1                  | 120 | pA               |
|                |   |                                 | −40°C to 85°C  |     |                    | 250 |                  |
|                |   |                                 | −40°C to 125°C |     |                    | 3   | nA               |
| $I_{IO}$       | Input offset current                                    |                                 | 25°C           |     | 6.6                |     | fA               |
| CMRR           | Common-mode rejection ratio                             | $0 \leq V_{ICR} \leq 1.7$ V     | 25°C           | 56  | 80                 |     | dB               |
|                |   | $0 \leq V_{ICR} \leq 1.6$ V     | Full range     | 50  |                    |     |                  |
| $k_{SVR}$      | Supply-voltage rejection ratio                          | $2.7$ V $\leq V_+ \leq 5$ V     | 25°C           | 65  | 82                 |     | dB               |
|                |   |                                 | Full range     | 60  |                    |     |                  |
| $V_{ICR}$      | Common-mode input voltage range                         | Lower range, CMRR $\geq 50$ dB  | 25°C           |     | −0.2               | 0   | V                |
|                |   | Upper range, CMRR $\geq 50$ dB  | 25°C           | 1.7 | 1.9                |     |                  |
| $A_V$          | Large-signal voltage gain <sup>(2)</sup>                | $R_L = 10$ k $\Omega$ to 1.35 V | 25°C           | 78  | 113                |     | dB               |
|                |   |                                 | Full range     | 70  |                    |     |                  |
|                |   | $R_L = 2$ k $\Omega$ to 1.35 V  | 25°C           | 72  | 103                |     |                  |
|                |   |                                 | Full range     | 64  |                    |     |                  |

(1) Typical values represent the most likely parametric norm.

(2) GND + 0.2 V  $\leq V_O \leq V_+ - 0.2$  V

**Electrical Characteristics:  $V_+ = 2.7\text{ V}$  (continued)**
 $V_+ = 2.7\text{ V}$ ,  $GND = 0\text{ V}$ ,  $V_{IC} = V_O = V_+/2$ ,  $R_L > 1\text{ M}\Omega$  (unless otherwise noted)

| PARAMETER |   | TEST CONDITIONS   |                   | $T_A$              | MIN | TYP <sup>(1)</sup> | MAX | UNIT                         |
|-----------|---|---|-------------------|--------------------|-----|--------------------|-----|------------------------------|
| $V_O$     | Output swing<br>(delta from supply rails) | $R_L = 2\text{ k}\Omega$ to $1.35\text{ V}$                                       | Low level         | $25^\circ\text{C}$ |     | 24                 | 60  | mV                           |
|           |   |   |                   | Full range         |     |                    | 95  |                              |
|           |   |   | High level        | $25^\circ\text{C}$ |     | 26                 | 60  |                              |
|           |   |   |                   | Full range         |     |                    | 95  |                              |
|           |   | $R_L = 10\text{ k}\Omega$ to $1.35\text{ V}$                                      | Low level         | $25^\circ\text{C}$ |     | 5                  | 30  |                              |
|           |   |   |                   | Full range         |     |                    | 40  |                              |
|           |   |   | High level        | $25^\circ\text{C}$ |     | 5.3                | 30  |                              |
|           |   |   |                   | Full range         |     |                    | 40  |                              |
| $I_{CC}$  | Supply current (per channel)              |   |                   | $25^\circ\text{C}$ |     | 100                | 170 | $\mu\text{A}$                |
|           |   |   |                   | Full range         |     |                    | 230 |                              |
| $I_{OS}$  | Output short-circuit current              | Sourcing  | LMV341,<br>LMV342 | $25^\circ\text{C}$ |     | 20                 | 32  | mA                           |
|           |   |   |                   |                    |     | LMV344             | 18  |                              |
|           |   | Sinking   |                   |                    |     | 15                 | 24  |                              |
| SR        | Slew rate                                 | $R_L = 10\text{ k}\Omega$ <sup>(3)</sup>  |                   | $25^\circ\text{C}$ |     | 1                  |     | $\text{V}/\mu\text{s}$       |
| GBM       | Unity-gain bandwidth                      | $R_L = 10\text{ k}\Omega$ , $C_L = 200\text{ pF}$                                 |                   | $25^\circ\text{C}$ |     | 1                  |     | MHz                          |
| $\Phi_m$  | Phase margin                              | $R_L = 100\text{ k}\Omega$  |                   | $25^\circ\text{C}$ |     | 72                 |     | $^\circ$                     |
| $G_m$     | Gain margin                               | $R_L = 100\text{ k}\Omega$  |                   | $25^\circ\text{C}$ |     | 20                 |     | dB                           |
| $V_n$     | Equivalent input noise voltage            | $f = 1\text{ kHz}$  |                   | $25^\circ\text{C}$ |     | 40                 |     | $\text{nV}/\sqrt{\text{Hz}}$ |
| $I_n$     | Equivalent input noise current            | $f = 1\text{ kHz}$  |                   | $25^\circ\text{C}$ |     | 0.001              |     | $\text{pA}/\sqrt{\text{Hz}}$ |
| THD       | Total harmonic distortion                 | $f = 1\text{ kHz}$ , $A_V = 1$ ,<br>$R_L = 600\ \Omega$ , $V_I = 1\text{ V}_{PP}$ |                   | $25^\circ\text{C}$ |     | 0.017%             |     |                              |

(3) Connected as voltage follower with  $2\text{-}V_{PP}$  step input. Number specified is the slower of the positive and negative slew rates.

**6.6 Electrical Characteristics:  $V_+ = 5\text{ V}$** 
 $V_+ = 5\text{ V}$ ,  $GND = 0\text{ V}$ ,  $V_{IC} = V_O = V_+/2$ ,  $R_L > 1\text{ M}\Omega$  (unless otherwise noted)

| PARAMETER      |   | TEST CONDITIONS                              |  | $T_A$                                      | MIN | TYP <sup>(1)</sup> | MAX | UNIT                         |
|----------------|---|--|--|--|-----|--------------------|-----|------------------------------|
| $V_{IO}$       | Input offset voltage                                    |  |  | $25^\circ\text{C}$                         |     | 0.25               | 4   | mV                           |
|                |   |  |  | Full range                                 |     |                    | 4.5 |                              |
| $\alpha_{VIO}$ | Average temperature coefficient of input offset voltage |  |  | Full range                                 |     | 1.9                |     | $\mu\text{V}/^\circ\text{C}$ |
| $I_{IB}$       | Input bias current                                      |  |  | $25^\circ\text{C}$                         |     | 1                  | 200 | pA                           |
|                |   |  |  | $-40^\circ\text{C}$ to $85^\circ\text{C}$  |     |                    | 375 |                              |
|                |   |  |  | $-40^\circ\text{C}$ to $125^\circ\text{C}$ |     |                    |     | 5                            |
| $I_{IO}$       | Input offset current                                    |  |  | $25^\circ\text{C}$                         |     | 6.6                |     | fA                           |
| CMRR           | Common-mode rejection ratio                             | $0 \leq V_{ICR} \leq 4\text{ V}$             |  | $25^\circ\text{C}$                         | 56  | 86                 |     | dB                           |
|                |   | $0 \leq V_{ICR} \leq 3.9\text{ V}$           |  | Full range                                 | 50  |                    |     |                              |
| $k_{SVR}$      | Supply-voltage rejection ratio                          | $2.7\text{ V} \leq V_+ \leq 5\text{ V}$      |  | $25^\circ\text{C}$                         | 65  | 82                 |     | dB                           |
|                |   |  |  | Full range                                 | 60  |                    |     |                              |
| $V_{ICR}$      | Common-mode input voltage range                         | Lower range, $\text{CMRR} \geq 50\text{ dB}$ |  | $25^\circ\text{C}$                         |     | -0.2               | 0   | V                            |
|                |   | Upper range, $\text{CMRR} \geq 50\text{ dB}$ |  | $25^\circ\text{C}$                         | 4   | 4.2                |     |                              |
| $A_V$          | Large-signal voltage gain <sup>(2)</sup>                | $R_L = 10\text{ k}\Omega$ to $2.5\text{ V}$  |  | $25^\circ\text{C}$                         | 78  | 116                |     | dB                           |
|                |   |  |  | Full range                                 | 70  |                    |     |                              |
|                |   | $R_L = 2\text{ k}\Omega$ to $2.5\text{ V}$   |  | $25^\circ\text{C}$                         | 72  | 107                |     |                              |
|                |   |  |  | Full range                                 | 64  |                    |     |                              |

(1) Typical values represent the most likely parametric norm.

(2)  $GND + 0.2\text{ V} \leq V_O \leq V_+ - 0.2\text{ V}$

**Electrical Characteristics:  $V_+ = 5\text{ V}$  (continued)**
 $V_+ = 5\text{ V}$ ,  $\text{GND} = 0\text{ V}$ ,  $V_{\text{IC}} = V_{\text{O}} = V_+/2$ ,  $R_{\text{L}} > 1\text{ M}\Omega$  (unless otherwise noted)

| PARAMETER         |   | TEST CONDITIONS   |                   | $T_{\text{A}}$     | MIN | TYP <sup>(1)</sup> | MAX | UNIT                   |
|-------------------|---|---|-------------------|--------------------|-----|--------------------|-----|------------------------|
| $V_{\text{O}}$    | Output swing<br>(delta from supply rails) | $R_{\text{L}} = 2\text{ k}\Omega$ to $2.5\text{ V}$   | Low level         | $25^\circ\text{C}$ |     | 32                 | 60  | mV                     |
|                   |   |   |                   | Full range         |     |                    | 95  |                        |
|                   |   |   | High level        | $25^\circ\text{C}$ |     | 34                 | 60  |                        |
|                   |   |   |                   | Full range         |     |                    | 95  |                        |
|                   |   | $R_{\text{L}} = 10\text{ k}\Omega$ to $2.5\text{ V}$  | Low level         | $25^\circ\text{C}$ |     | 7                  | 30  |                        |
|                   |   |   |                   | Full range         |     |                    | 40  |                        |
|                   |   |   | High level        | $25^\circ\text{C}$ |     | 7                  | 30  |                        |
|                   |   |   |                   | Full range         |     |                    | 40  |                        |
| $I_{\text{CC}}$   | Supply current (per channel)              |   |                   | $25^\circ\text{C}$ |     | 107                | 200 | $\mu\text{A}$          |
|                   |   |   |                   | Full range         |     |                    | 260 |                        |
| $I_{\text{OS}}$   | Output short-circuit current              | Sourcing  | LMV341,<br>LMV342 | $25^\circ\text{C}$ |     | 85                 | 113 | mA                     |
|                   |   |   | LMV344            |                    |     | 85                 | 113 |                        |
|                   |   | Sinking   |                   |                    |     | 50                 | 75  |                        |
| SR                | Slew rate                                 | $R_{\text{L}} = 10\text{ k}\Omega$ <sup>(3)</sup>   |                   | $25^\circ\text{C}$ |     | 1                  |     | V/ $\mu\text{s}$       |
| GBM               | Unity-gain bandwidth                      | $R_{\text{L}} = 10\text{ k}\Omega$ , $C_{\text{L}} = 200\text{ pF}$   |                   | $25^\circ\text{C}$ |     | 1                  |     | MHz                    |
| $\Phi_{\text{m}}$ | Phase margin                              | $R_{\text{L}} = 100\text{ k}\Omega$   |                   | $25^\circ\text{C}$ |     | 70                 |     | $^\circ$               |
| $G_{\text{m}}$    | Gain margin                               | $R_{\text{L}} = 100\text{ k}\Omega$   |                   | $25^\circ\text{C}$ |     | 20                 |     | dB                     |
| $V_{\text{n}}$    | Equivalent input noise voltage            | $f = 1\text{ kHz}$  |                   | $25^\circ\text{C}$ |     | 39                 |     | nV/ $\sqrt{\text{Hz}}$ |
| $I_{\text{n}}$    | Equivalent input noise current            | $f = 1\text{ kHz}$  |                   | $25^\circ\text{C}$ |     | 0.001              |     | pA/ $\sqrt{\text{Hz}}$ |
| THD               | Total harmonic distortion                 | $f = 1\text{ kHz}$ , $A_{\text{V}} = 1$ ,<br>$R_{\text{L}} = 600\ \Omega$ , $V_{\text{I}} = 1\text{ V}_{\text{PP}}$ |                   | $25^\circ\text{C}$ |     | 0.012%             |     |                        |

(3) Connected as voltage follower with  $2\text{-V}_{\text{PP}}$  step input. Number specified is the slower of the positive and negative slew rates.

**6.7 Shutdown Characteristics:  $V_+ = 2.7\text{ V}$** 
 $V_+ = 2.7\text{ V}$ ,  $\text{GND} = 0\text{ V}$ ,  $V_{\text{IC}} = V_{\text{O}} = V_+/2$ ,  $R_{\text{L}} > 1\text{ M}\Omega$  (unless otherwise noted)

| PARAMETER             |  | TEST CONDITIONS              |  | $T_{\text{A}}$     | MIN | TYP   | MAX  | UNIT          |
|-----------------------|--|------------------------------|--|--------------------|-----|-------|------|---------------|
| $I_{\text{CC(SHDN)}}$ | Supply current in shutdown mode        | $V_{\text{SD}} = 0\text{ V}$ |  | $25^\circ\text{C}$ |     | 0.045 | 1000 | nA            |
|                       |  |                              |  | Full range         |     |       | 1.5  | $\mu\text{A}$ |
| $t_{\text{(on)}}$     | Amplifier turnon time                  |                              |  | $25^\circ\text{C}$ |     | 5     |      | $\mu\text{s}$ |
| $V_{\text{SD}}$       | Recommended shutdown pin voltage range | ON mode                      |  | $25^\circ\text{C}$ |     | 2.4   | 2.7  | V             |
|                       |  | Shutdown mode                |  |                    |     | 0     | 0.8  |               |

**6.8 Shutdown Characteristics:  $V_+ = 5\text{ V}$** 
 $V_+ = 5\text{ V}$ ,  $\text{GND} = 0\text{ V}$ ,  $V_{\text{IC}} = V_{\text{O}} = V_+/2$ ,  $R_{\text{L}} > 1\text{ M}\Omega$  (unless otherwise noted)

| PARAMETER             |  | TEST CONDITIONS              |  | $T_{\text{A}}$     | MIN | TYP   | MAX | UNIT          |
|-----------------------|--|------------------------------|--|--------------------|-----|-------|-----|---------------|
| $I_{\text{CC(SHDN)}}$ | Supply current in shutdown mode        | $V_{\text{SD}} = 0\text{ V}$ |  | $25^\circ\text{C}$ |     | 0.033 | 1   | $\mu\text{A}$ |
|                       |  |                              |  | Full range         |     |       | 1.5 |               |
| $t_{\text{(on)}}$     | Amplifier turnon time                  |                              |  | $25^\circ\text{C}$ |     | 5     |     | $\mu\text{s}$ |
| $V_{\text{SD}}$       | Recommended shutdown pin voltage range | ON mode                      |  | $25^\circ\text{C}$ |     | 4.5   | 5   | V             |
|                       |  | Shutdown mode                |  |                    |     | 0     | 0.8 |               |

## 6.9 Typical Characteristics

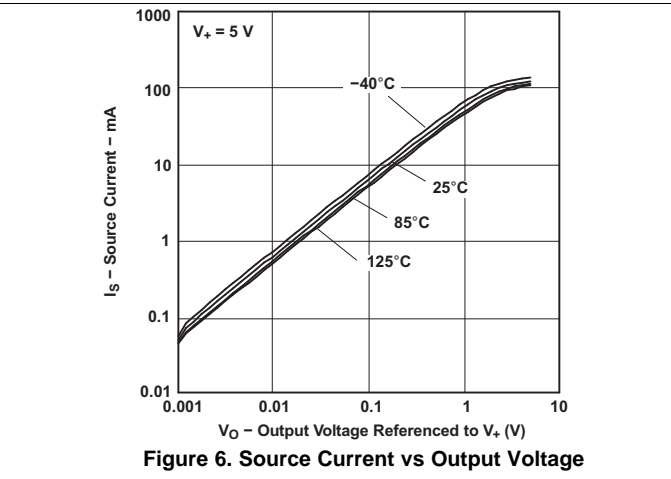
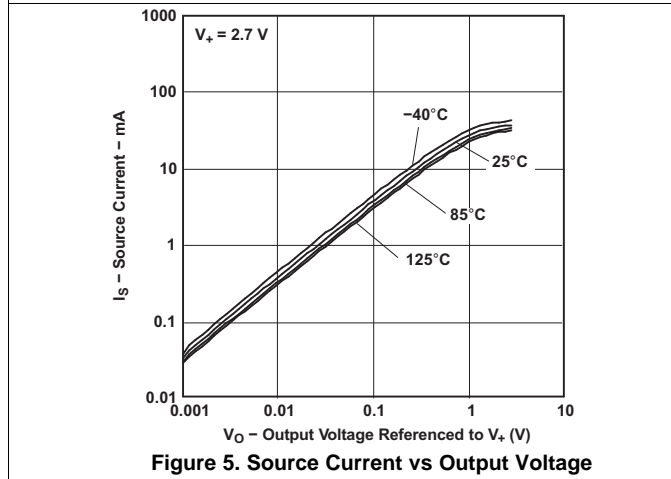
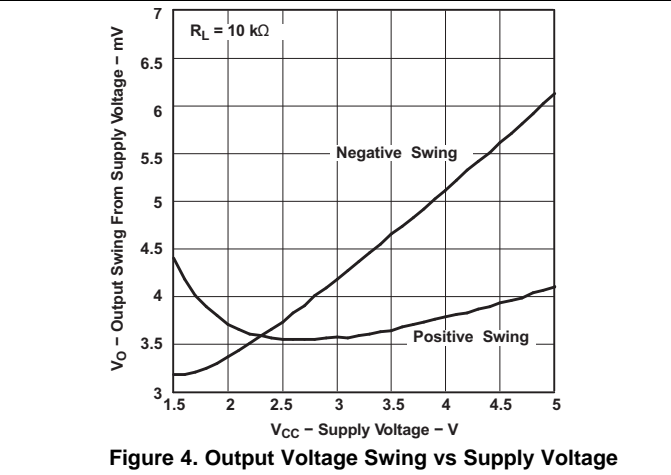
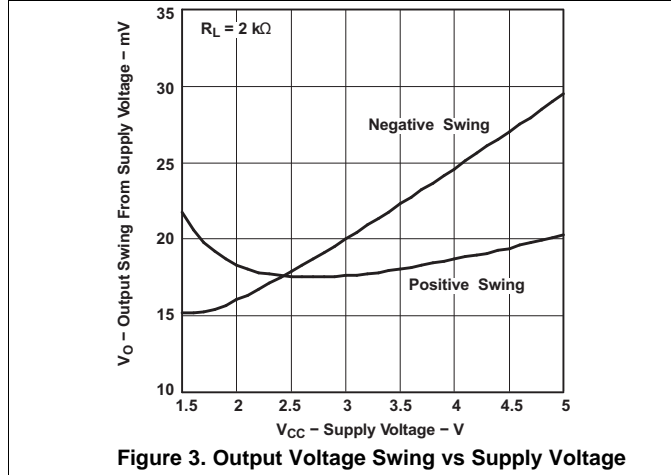
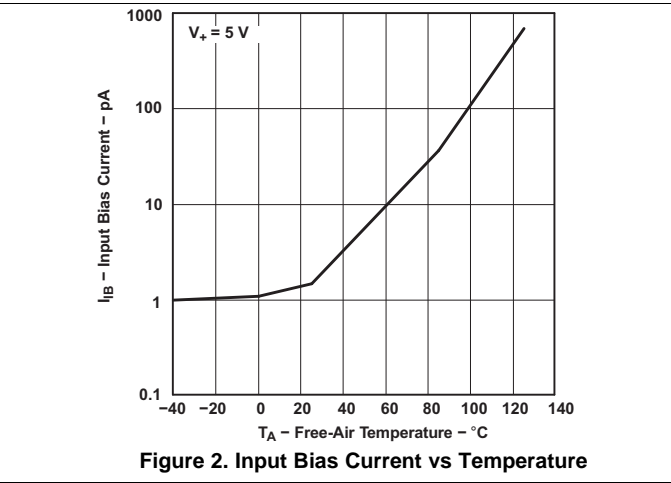
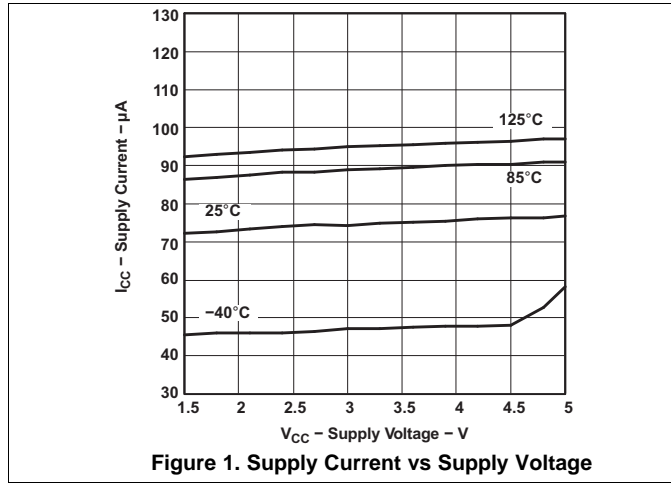



Typical Characteristics (continued)

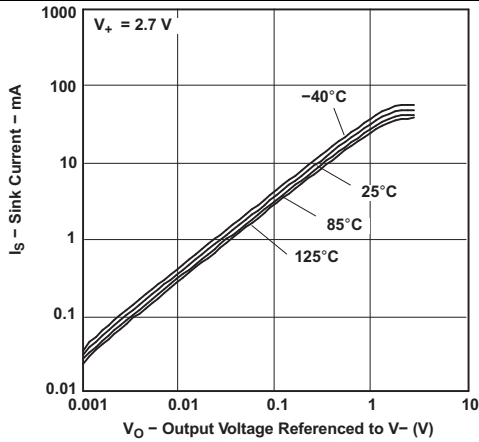

Figure 7. Sink Current vs Output Voltage

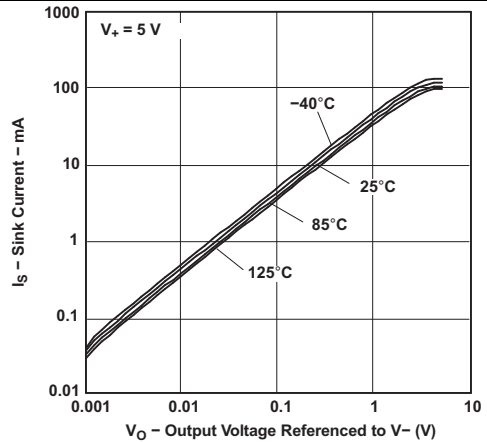

Figure 8. Sink Current vs Output Voltage

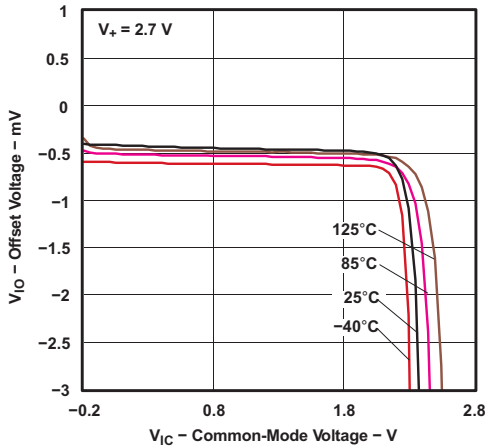

Figure 9. Offset Voltage vs Common-Mode Voltage

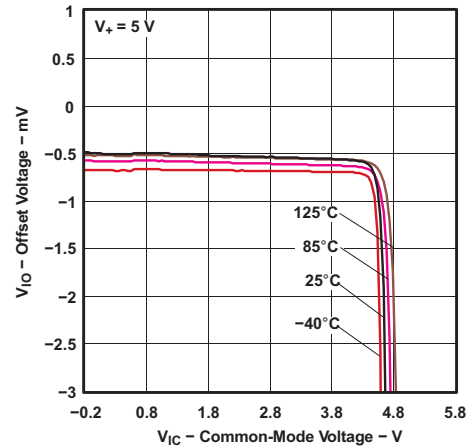

Figure 10. Offset Voltage vs Common-Mode Voltage

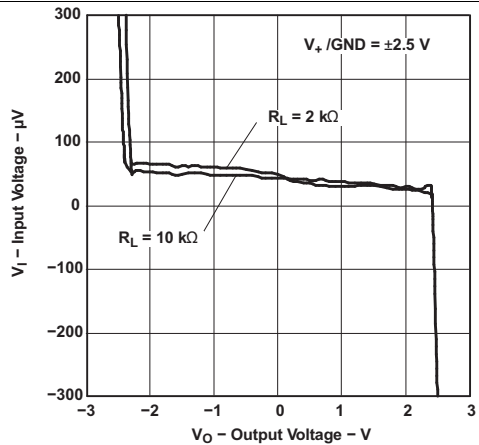

Figure 11. Input Voltage vs Output Voltage

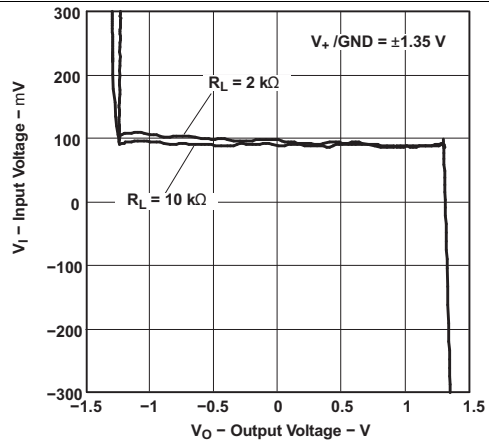

Figure 12. Input Voltage vs Output Voltage

Typical Characteristics (continued)

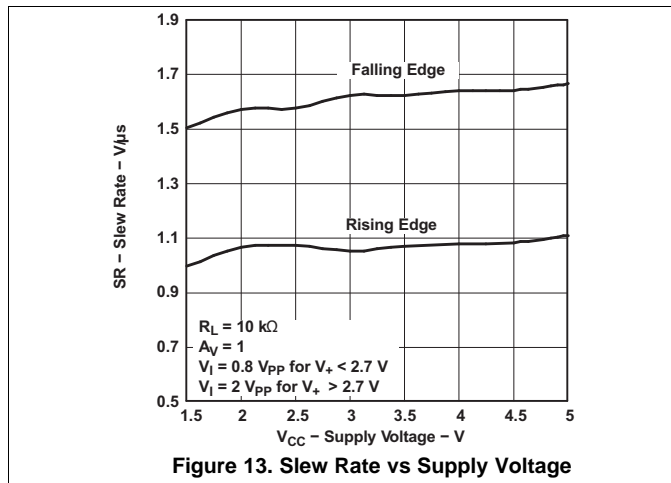

Figure 13. Slew Rate vs Supply Voltage

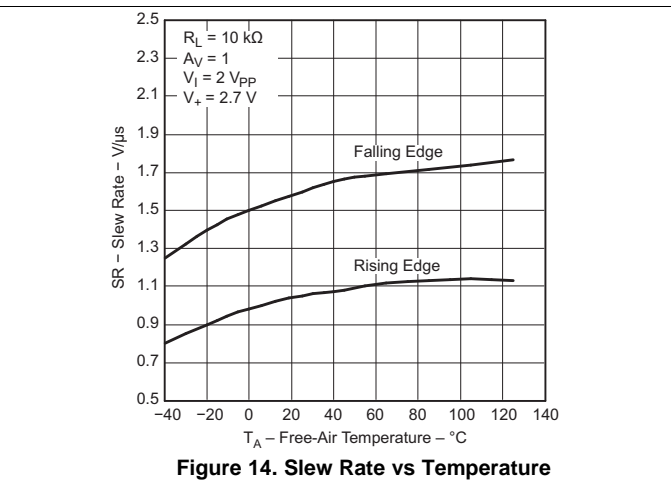

Figure 14. Slew Rate vs Temperature

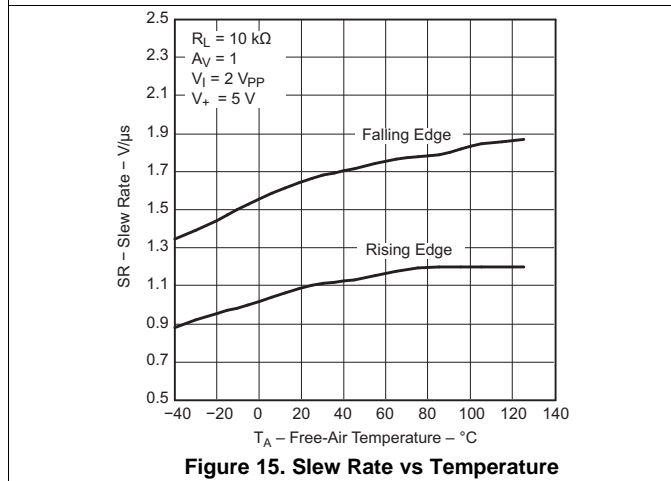

Figure 15. Slew Rate vs Temperature

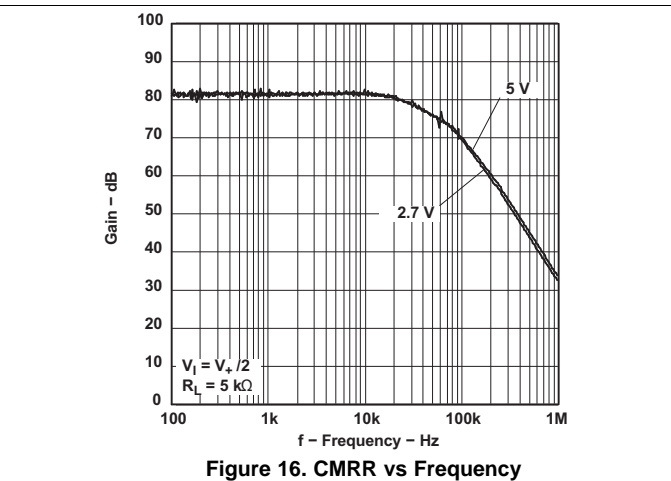

Figure 16. CMRR vs Frequency

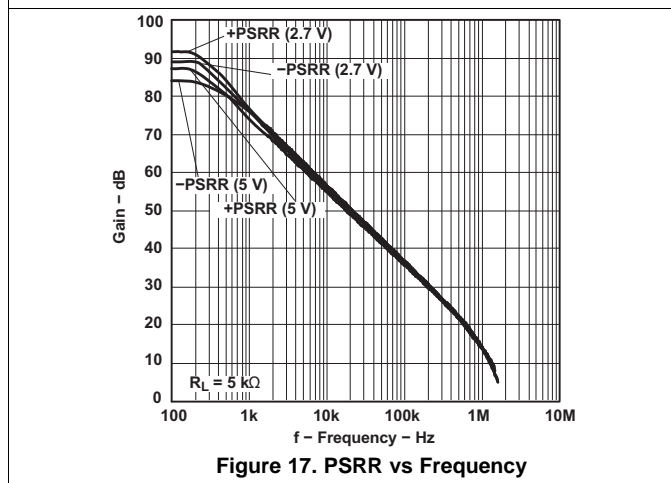

Figure 17. PSRR vs Frequency

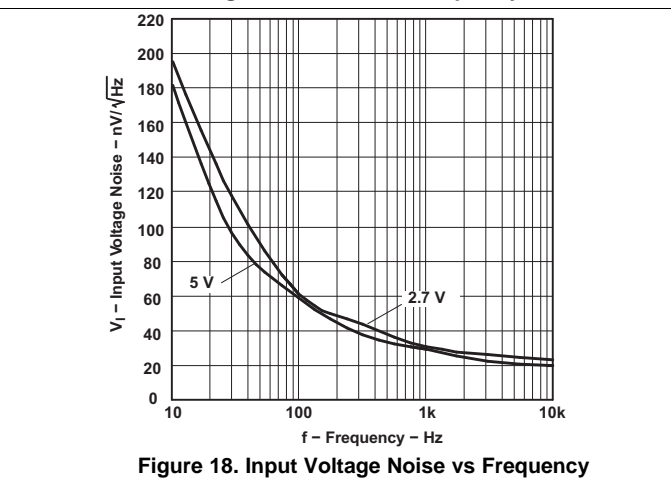

Figure 18. Input Voltage Noise vs Frequency

Typical Characteristics (continued)

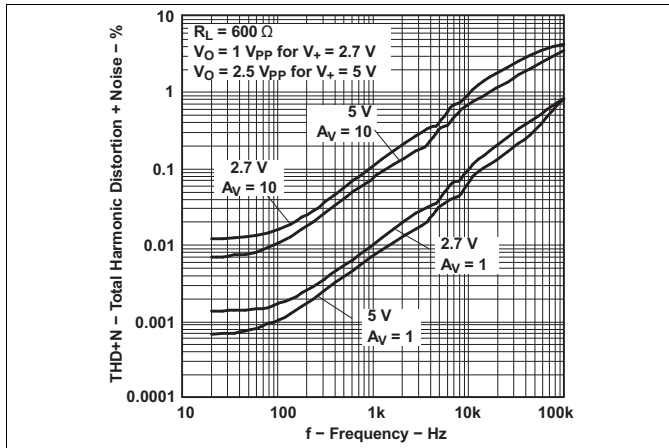

Figure 19. Total Harmonic Distortion + Noise vs Frequency

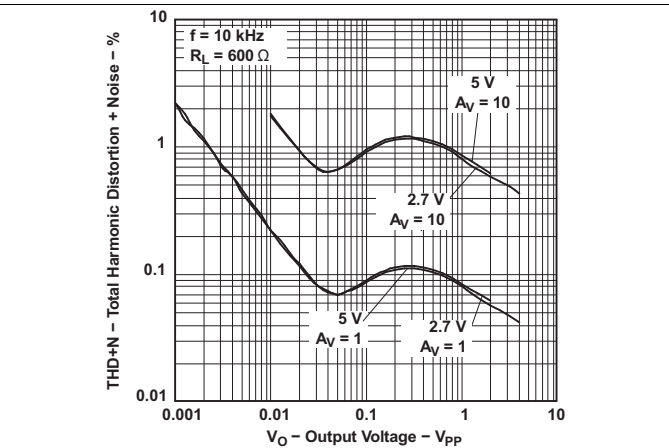
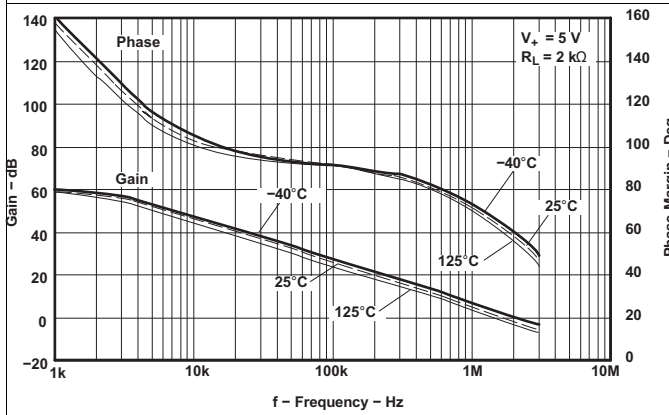
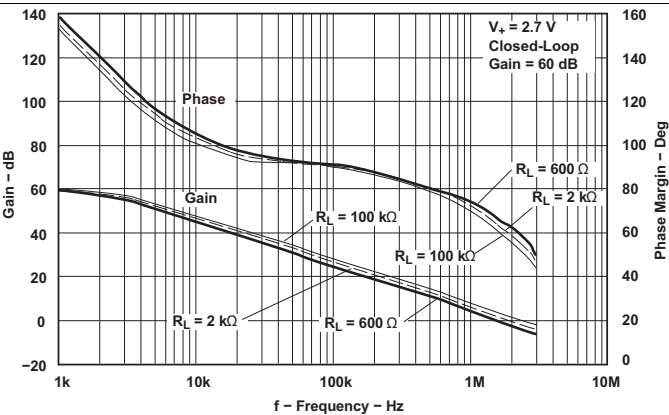

Figure 20. Total Harmonic Distortion + Noise vs Output Voltage



( $T_A = -40^\circ\text{C}, 25^\circ\text{C}, 125^\circ\text{C}$ )

Figure 21. Gain and Phase Margin vs Frequency



( $R_L = 600 \Omega, 2 \text{ k}\Omega, 100 \text{ k}\Omega$ )

Figure 22. Gain and Phase Margin vs Frequency

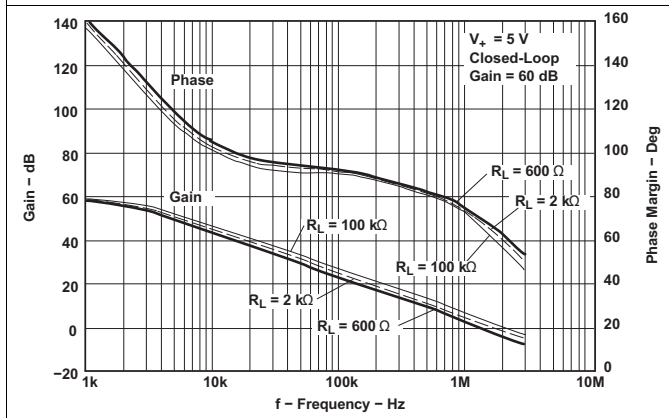

( $R_L = 600 \Omega, 2 \text{ k}\Omega, 100 \text{ k}\Omega$ )

Figure 23. Gain and Phase Margin vs Frequency

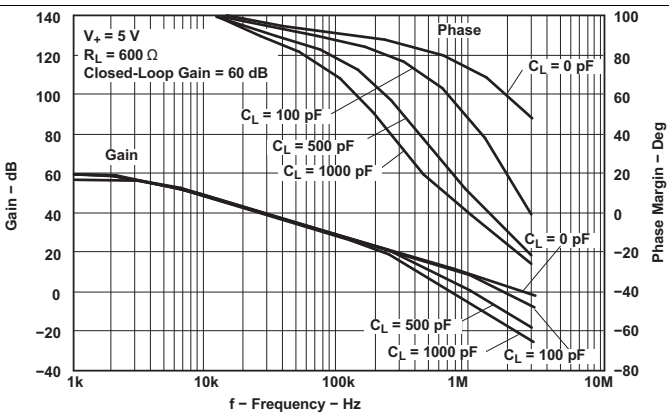

( $C_L = 0 \text{ pF}, 100 \text{ pF}, 500 \text{ pF}, 1000 \text{ pF}$ )

Figure 24. Gain and Phase Margin vs Frequency

Typical Characteristics (continued)

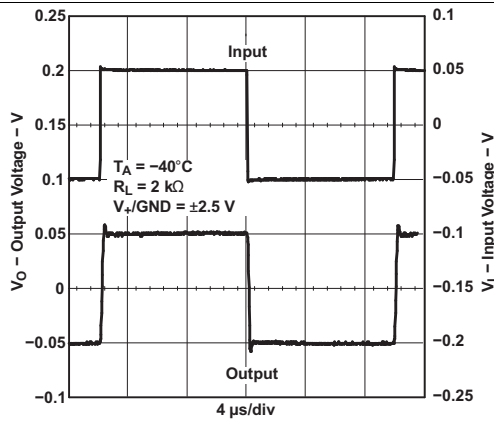

Figure 25. Small-Signal Noninverting Response

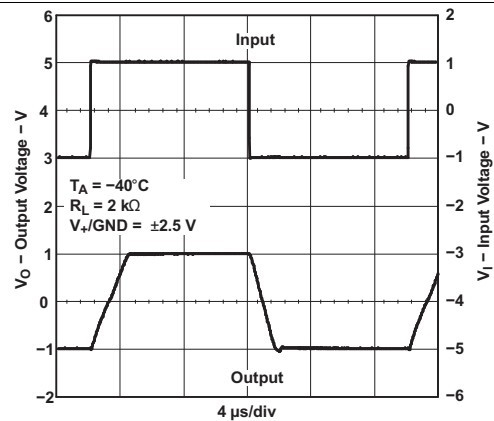

Figure 26. Large-Signal Noninverting Response

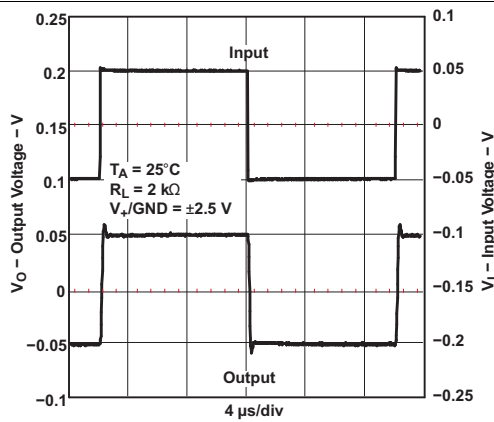

Figure 27. Small-Signal Noninverting Response

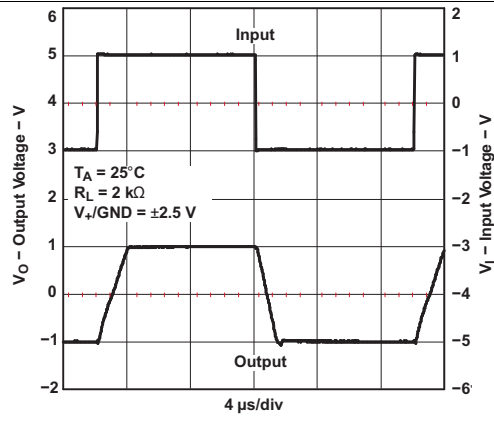

Figure 28. Large-Signal Noninverting Response

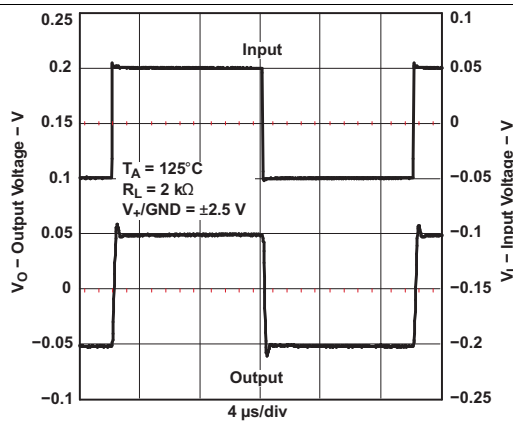

Figure 29. Small-Signal Noninverting Response

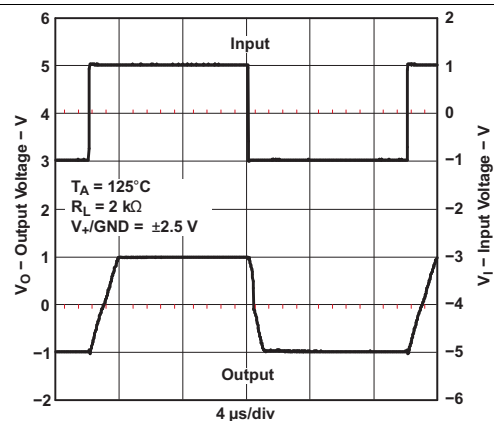

Figure 30. Large-Signal Noninverting Response

Typical Characteristics (continued)

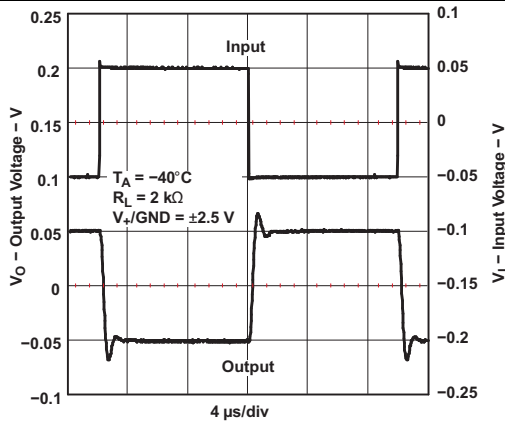

Figure 31. Small-Signal Inverting Response

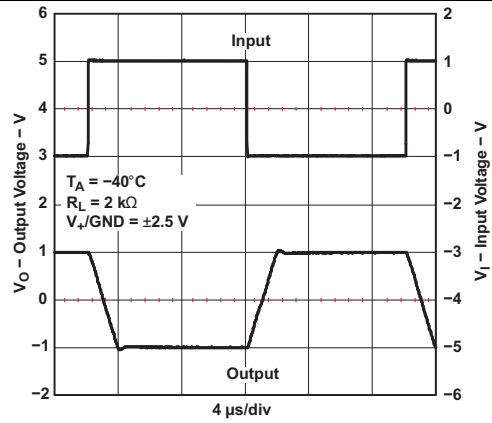

Figure 32. Large-Signal Inverting Response

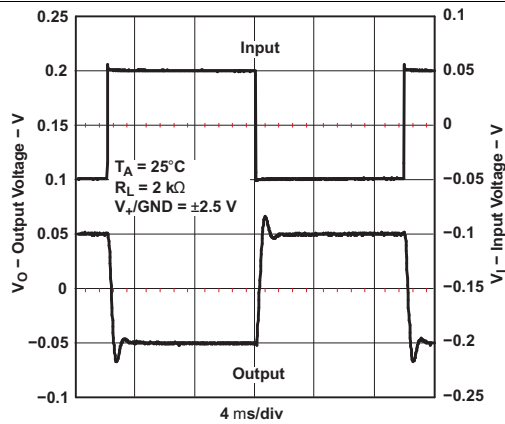

Figure 33. Small-Signal Inverting Response

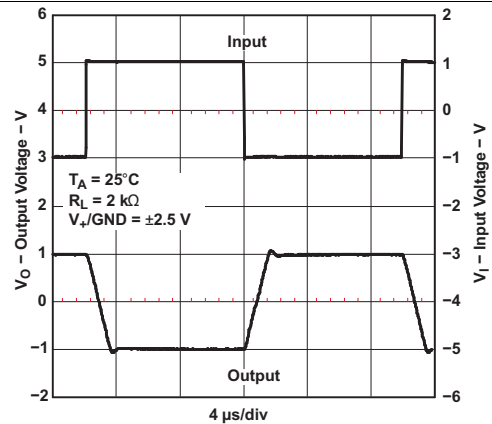

Figure 34. Large-Signal Inverting Response

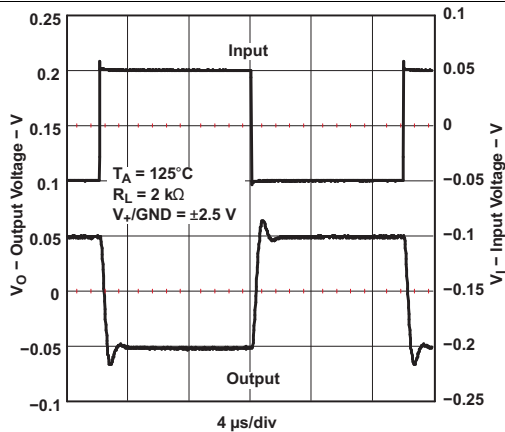

Figure 35. Small-Signal Inverting Response

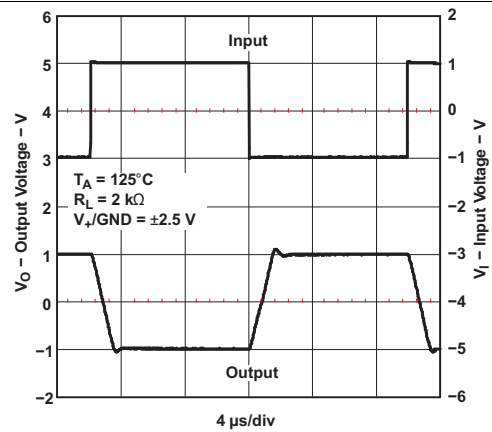

Figure 36. Large-Signal Inverting Response

## 7 Detailed Description

### 7.1 Overview

The LMV34x devices are precision operational amplifiers with CMOS inputs for very low input bias current. Output is rail-to-rail and input common-mode includes ground. LMV341 has a shutdown mode for very low supply current.

### 7.2 Functional Block Diagram

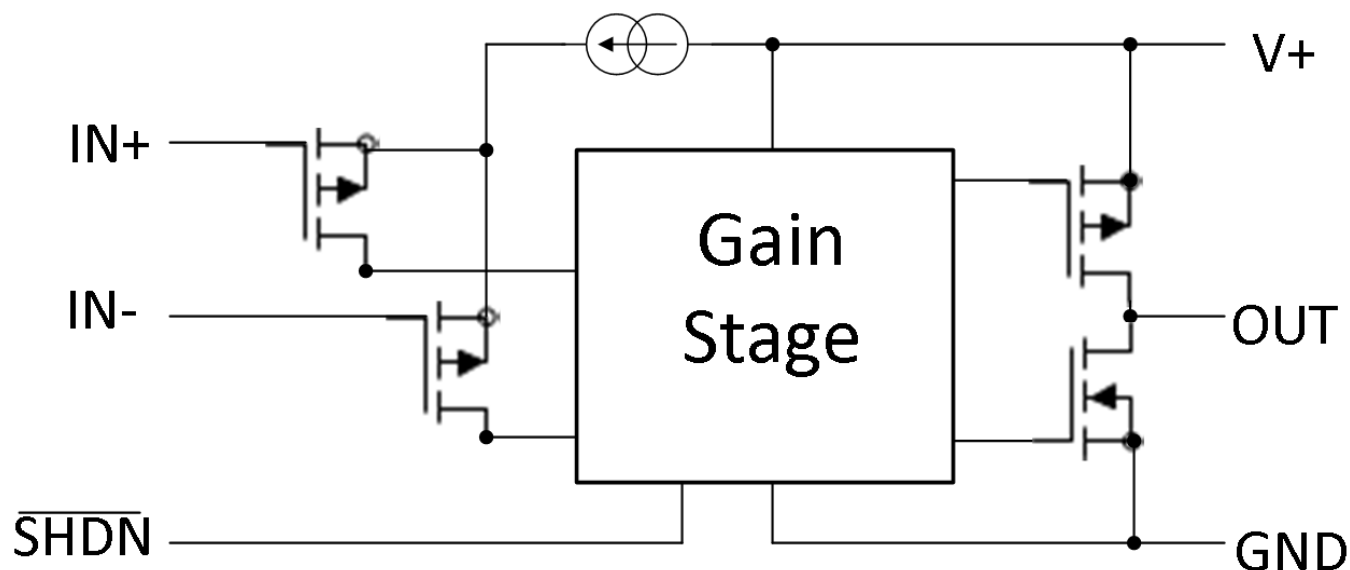

### 7.3 Feature Description

#### 7.3.1 PMOS Input Stage

PMOS Input Stage supports a lower input range that includes ground. Upper range limit is  $V_+ - 1\text{ V}$ .

#### 7.3.2 CMOS Output Stage

The CMOS drain output topology allows rail-to-rail output swing.

#### 7.3.3 Shutdown

LMV341 includes a shutdown pin. During shutdown,  $I_{CC}$  is nearly zero and the output becomes high impedance. The typical turnon time coming out of shutdown is 5  $\mu\text{s}$ .

### 7.4 Device Functional Modes

The LMV34x devices have two modes of operation:

- Normal operation when  $\overline{\text{SHDN}}$  pin is at  $V_+$  level or the  $\overline{\text{SHDN}}$  pin is not present
- Shutdown mode when  $\overline{\text{SHDN}}$  is at GND level;  $I_{CC}$  is very low and output is high impedance.

## 8 Application and Implementation

### NOTE

Information in the following applications sections is not part of the TI component specification, and TI does not warrant its accuracy or completeness. TI's customers are responsible for determining suitability of components for their purposes. Customers should validate and test their design implementation to confirm system functionality.

### 8.1 Application Information

LMV34x devices have rail-to-rail output and input range from ground to  $V_{CC} - 1$  V. CMOS inputs provide very low input current. Shutdown capability is an option in dual amplifier version. Operation from 2.5-V to 5.5-V is possible.

### 8.2 Typical Application

A typical application for an operational amplifier in an inverting amplifier. This amplifier takes a positive voltage on the input, and makes it a negative voltage of the same magnitude. In the same manner, it also makes negative voltages positive.

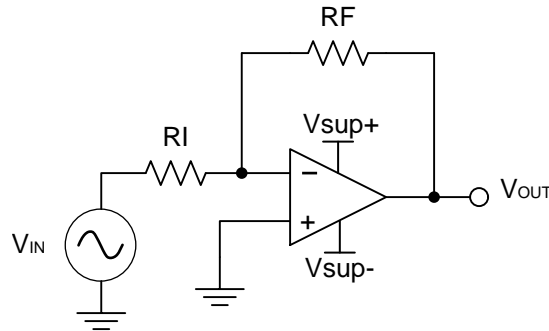

Copyright © 2016, Texas Instruments Incorporated

**Figure 37. Application Schematic**

#### 8.2.1 Design Requirements

The supply voltage must be chosen such that it is larger than the input voltage range and output range. For instance, this application scales a signal of  $\pm 0.5$  V to  $\pm 1.8$  V. Setting the supply at  $\pm 2$  V is sufficient to accommodate this application. The supplies can power up in any order; however, neither supply can be of opposite polarity relative to ground at any time; otherwise, a large current can flow through the input ESD diodes. To limit current in such an occurrence, TI highly recommends adding a series resistor to the grounded input.  $V_{sup+}$  must be more positive than  $V_{sup-}$  at all times; otherwise, a large reverse supply current may flow.

#### 8.2.2 Detailed Design Procedure

Determine the gain required by the inverting amplifier using [Equation 1](#) and [Equation 2](#).

$$A_v = \frac{V_{OUT}}{V_{IN}} \quad (1)$$

$$A_v = \frac{1.8}{-0.5} = -3.6 \quad (2)$$

Once the desired gain is determined, choose a value for  $R_I$  or  $R_F$ . Choosing a value in the  $k\Omega$  range is desirable because the amplifier circuit uses currents in the mA range. This ensures the part does not draw too much current. For this example, choose 10  $k\Omega$  for  $R_I$ , which means 36  $k\Omega$  is used for  $R_F$ . This was determined by [Equation 3](#).

$$A_v = -\frac{R_F}{R_I} \quad (3)$$

## Typical Application (continued)

### 8.2.3 Application Curve

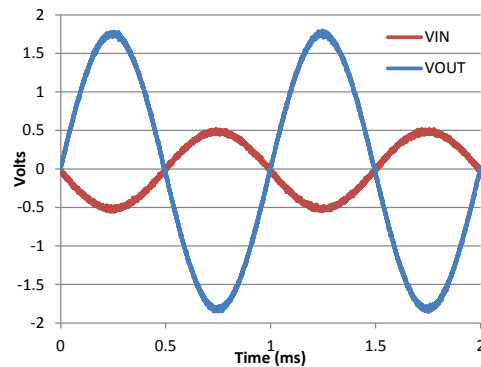

**Figure 38. Input and Output Voltages of the Inverting Amplifier**

## 9 Power Supply Recommendations

### CAUTION

Supply voltages larger than 5.5 V for a single supply can permanently damage the device (see the [Absolute Maximum Ratings](#)).

Place 0.1- $\mu$ F bypass capacitors close to the power-supply pins to reduce errors coupling in from noisy or high-impedance power supplies.



## 10 Layout

### 10.1 Layout Guidelines

For best operational performance of the device, use good PCB layout practices, including:

- Noise can propagate into analog circuitry through the power pins of the circuit as a whole, as well as the operational amplifier. Bypass capacitors are used to reduce the coupled noise by providing low-impedance power sources local to the analog circuitry.
  - Connect low-ESR, 0.1- $\mu\text{F}$  ceramic bypass capacitors between each supply pin and ground, placed as close to the device as possible. A single bypass capacitor from  $V_+$  to ground is applicable for single-supply applications.
- Separate grounding for analog and digital portions of circuitry is one of the simplest and most effective methods of noise suppression. One or more layers on multilayer PCBs are usually devoted to ground planes. A ground plane helps distribute heat and reduces EMI noise pickup. Make sure to physically separate digital and analog grounds, and pay attention to the flow of the ground current.
- To reduce parasitic coupling, run the input traces as far away from the supply or output traces as possible. If it is not possible to keep them separate, it is much better to cross the sensitive trace perpendicular as opposed to in parallel with the noisy trace.
- Place the external components as close to the device as possible. Keeping  $R_F$  and  $R_G$  close to the inverting input minimizes parasitic capacitance, as shown in [Layout Examples](#).
- Keep the length of input traces as short as possible. Always remember that the input traces are the most sensitive part of the circuit.
- Consider a driven, low-impedance guard ring around the critical traces. A guard ring can significantly reduce leakage currents from nearby traces that are at different potentials.

### 10.2 Layout Examples

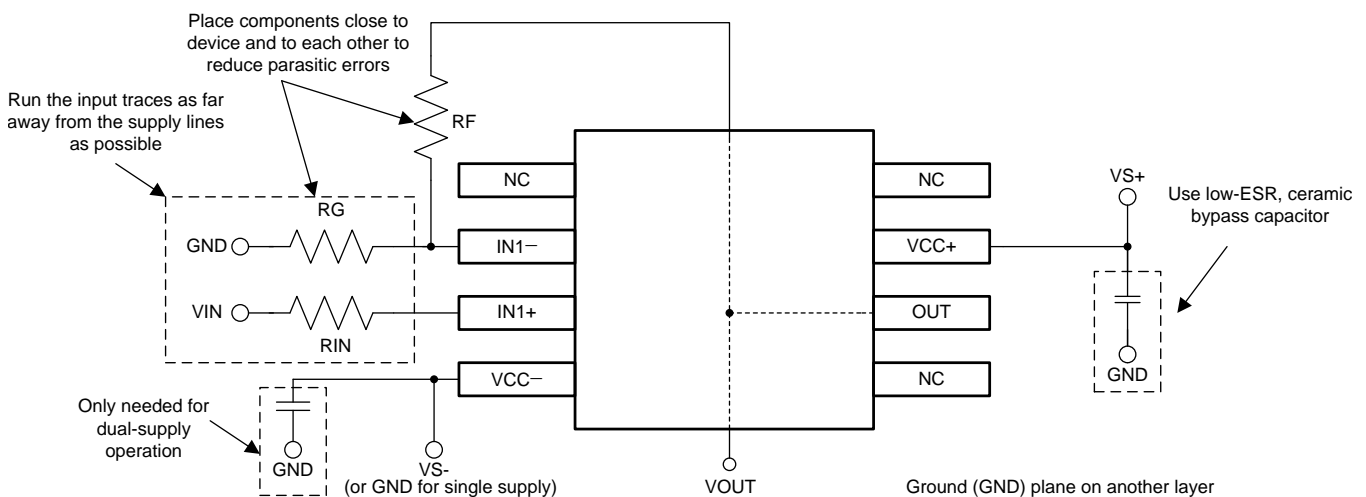

Figure 39. Operational Amplifier Layout for Noninverting Configuration

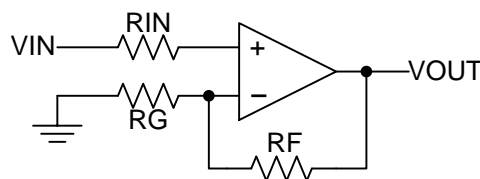

Figure 40. Operational Amplifier Schematic for Noninverting Configuration

## 11 Device and Documentation Support

### 11.1 Related Links

The table below lists quick access links. Categories include technical documents, support and community resources, tools and software, and quick access to sample or buy.

**Table 1. Related Links**

| PARTS  | PRODUCT FOLDER             | SAMPLE & BUY               | TECHNICAL DOCUMENTS        | TOOLS & SOFTWARE           | SUPPORT & COMMUNITY        |
|--------|----------------------------|----------------------------|----------------------------|----------------------------|----------------------------|
| LMV341 | <a href="#">Click here</a> | <a href="#">Click here</a> | <a href="#">Click here</a> | <a href="#">Click here</a> | <a href="#">Click here</a> |
| LMV342 | <a href="#">Click here</a> | <a href="#">Click here</a> | <a href="#">Click here</a> | <a href="#">Click here</a> | <a href="#">Click here</a> |
| LMV344 | <a href="#">Click here</a> | <a href="#">Click here</a> | <a href="#">Click here</a> | <a href="#">Click here</a> | <a href="#">Click here</a> |

### 11.2 Community Resources

The following links connect to TI community resources. Linked contents are provided "AS IS" by the respective contributors. They do not constitute TI specifications and do not necessarily reflect TI's views; see TI's [Terms of Use](#).

**TI E2E™ Online Community** *TI's Engineer-to-Engineer (E2E) Community*. Created to foster collaboration among engineers. At [e2e.ti.com](http://e2e.ti.com), you can ask questions, share knowledge, explore ideas and help solve problems with fellow engineers.

**Design Support** *TI's Design Support* Quickly find helpful E2E forums along with design support tools and contact information for technical support.

### 11.3 Trademarks

E2E is a trademark of Texas Instruments.

All other trademarks are the property of their respective owners.

### 11.4 Electrostatic Discharge Caution



This integrated circuit can be damaged by ESD. Texas Instruments recommends that all integrated circuits be handled with appropriate precautions. Failure to observe proper handling and installation procedures can cause damage.

ESD damage can range from subtle performance degradation to complete device failure. Precision integrated circuits may be more susceptible to damage because very small parametric changes could cause the device not to meet its published specifications.

### 11.5 Glossary

[SLYZ022](#) — *TI Glossary*.

This glossary lists and explains terms, acronyms, and definitions.

## 12 Mechanical, Packaging, and Orderable Information

The following pages include mechanical, packaging, and orderable information. This information is the most current data available for the designated devices. This data is subject to change without notice and revision of this document. For browser-based versions of this data sheet, refer to the left-hand navigation.

**PACKAGING INFORMATION**

| Orderable Device | Status<br>(1) | Package Type | Package<br>Drawing | Pins | Package<br>Qty | Eco Plan<br>(2)            | Lead/Ball Finish<br>(6) | MSL Peak Temp<br>(3) | Op Temp (°C) | Device Marking<br>(4/5) | Samples                 |
|------------------|---------------|--------------|--------------------|------|----------------|----------------------------|-------------------------|----------------------|--------------|-------------------------|-------------------------|
| LMV341IDBVR      | ACTIVE        | SOT-23       | DBV                | 6    | 3000           | Green (RoHS<br>& no Sb/Br) | CU NIPDAU               | Level-1-260C-UNLIM   | -40 to 125   | (RC9A ~ RC9E)           | <a href="#">Samples</a> |
| LMV341IDBVRE4    | ACTIVE        | SOT-23       | DBV                | 6    | 3000           | Green (RoHS<br>& no Sb/Br) | CU NIPDAU               | Level-1-260C-UNLIM   | -40 to 125   | (RC9A ~ RC9E)           | <a href="#">Samples</a> |
| LMV341IDBVRG4    | ACTIVE        | SOT-23       | DBV                | 6    | 3000           | Green (RoHS<br>& no Sb/Br) | CU NIPDAU               | Level-1-260C-UNLIM   | -40 to 125   | (RC9A ~ RC9E)           | <a href="#">Samples</a> |
| LMV341IDCKR      | ACTIVE        | SC70         | DCK                | 6    | 3000           | Green (RoHS<br>& no Sb/Br) | CU NIPDAU               | Level-1-260C-UNLIM   | -40 to 125   | (R4A ~ R4E)             | <a href="#">Samples</a> |
| LMV341IDCKRG4    | ACTIVE        | SC70         | DCK                | 6    | 3000           | Green (RoHS<br>& no Sb/Br) | CU NIPDAU               | Level-1-260C-UNLIM   | -40 to 125   | (R4A ~ R4E)             | <a href="#">Samples</a> |
| LMV342ID         | ACTIVE        | SOIC         | D                  | 8    | 75             | Green (RoHS<br>& no Sb/Br) | CU NIPDAU               | Level-1-260C-UNLIM   | -40 to 125   | MV342I                  | <a href="#">Samples</a> |
| LMV342IDGKR      | ACTIVE        | VSSOP        | DGK                | 8    | 2500           | Green (RoHS<br>& no Sb/Br) | CU NIPDAU               | Level-1-260C-UNLIM   | -40 to 125   | RPA                     | <a href="#">Samples</a> |
| LMV342IDGKRG4    | ACTIVE        | VSSOP        | DGK                | 8    | 2500           | Green (RoHS<br>& no Sb/Br) | CU NIPDAU               | Level-1-260C-UNLIM   | -40 to 125   | RPA                     | <a href="#">Samples</a> |
| LMV342IDGKT      | PREVIEW       | VSSOP        | DGK                | 8    | 250            | TBD                        | Call TI                 | Call TI              | -40 to 125   |                         |                         |
| LMV342IDR        | ACTIVE        | SOIC         | D                  | 8    | 2500           | Green (RoHS<br>& no Sb/Br) | CU NIPDAU               | Level-1-260C-UNLIM   | -40 to 125   | MV342I                  | <a href="#">Samples</a> |
| LMV342IDRG4      | ACTIVE        | SOIC         | D                  | 8    | 2500           | Green (RoHS<br>& no Sb/Br) | CU NIPDAU               | Level-1-260C-UNLIM   | -40 to 125   | MV342I                  | <a href="#">Samples</a> |
| LMV344ID         | ACTIVE        | SOIC         | D                  | 14   | 50             | Green (RoHS<br>& no Sb/Br) | CU NIPDAU               | Level-1-260C-UNLIM   | -40 to 125   | LMV344I                 | <a href="#">Samples</a> |
| LMV344IDG4       | ACTIVE        | SOIC         | D                  | 14   | 50             | Green (RoHS<br>& no Sb/Br) | CU NIPDAU               | Level-1-260C-UNLIM   | -40 to 125   | LMV344I                 | <a href="#">Samples</a> |
| LMV344IDR        | ACTIVE        | SOIC         | D                  | 14   | 2500           | Green (RoHS<br>& no Sb/Br) | CU NIPDAU               | Level-1-260C-UNLIM   | -40 to 125   | LMV344I                 | <a href="#">Samples</a> |
| LMV344IDRE4      | ACTIVE        | SOIC         | D                  | 14   | 2500           | Green (RoHS<br>& no Sb/Br) | CU NIPDAU               | Level-1-260C-UNLIM   | -40 to 125   | LMV344I                 | <a href="#">Samples</a> |
| LMV344IDRG4      | ACTIVE        | SOIC         | D                  | 14   | 2500           | Green (RoHS<br>& no Sb/Br) | CU NIPDAU               | Level-1-260C-UNLIM   | -40 to 125   | LMV344I                 | <a href="#">Samples</a> |
| LMV344IPW        | ACTIVE        | TSSOP        | PW                 | 14   | 90             | Green (RoHS<br>& no Sb/Br) | CU NIPDAU               | Level-1-260C-UNLIM   | -40 to 125   | MV344I                  | <a href="#">Samples</a> |

| Orderable Device | Status<br>(1) | Package Type | Package Drawing | Pins | Package Qty | Eco Plan<br>(2)         | Lead/Ball Finish<br>(6) | MSL Peak Temp<br>(3) | Op Temp (°C) | Device Marking<br>(4/5) | Samples                 |
|------------------|---------------|--------------|-----------------|------|-------------|-------------------------|-------------------------|----------------------|--------------|-------------------------|-------------------------|
| LMV344IPWG4      | ACTIVE        | TSSOP        | PW              | 14   | 90          | Green (RoHS & no Sb/Br) | CU NIPDAU               | Level-1-260C-UNLIM   | -40 to 125   | MV344I                  | <a href="#">Samples</a> |
| LMV344IPWR       | ACTIVE        | TSSOP        | PW              | 14   | 2000        | Green (RoHS & no Sb/Br) | CU NIPDAU               | Level-1-260C-UNLIM   | -40 to 125   | MV344I                  | <a href="#">Samples</a> |
| LMV344IPWRE4     | ACTIVE        | TSSOP        | PW              | 14   | 2000        | Green (RoHS & no Sb/Br) | CU NIPDAU               | Level-1-260C-UNLIM   | -40 to 125   | MV344I                  | <a href="#">Samples</a> |
| LMV344IPWRG4     | ACTIVE        | TSSOP        | PW              | 14   | 2000        | Green (RoHS & no Sb/Br) | CU NIPDAU               | Level-1-260C-UNLIM   | -40 to 125   | MV344I                  | <a href="#">Samples</a> |

(1) The marketing status values are defined as follows:

**ACTIVE:** Product device recommended for new designs.

**LIFEBUY:** TI has announced that the device will be discontinued, and a lifetime-buy period is in effect.

**NRND:** Not recommended for new designs. Device is in production to support existing customers, but TI does not recommend using this part in a new design.

**PREVIEW:** Device has been announced but is not in production. Samples may or may not be available.

**OBSOLETE:** TI has discontinued the production of the device.

(2) Eco Plan - The planned eco-friendly classification: Pb-Free (RoHS), Pb-Free (RoHS Exempt), or Green (RoHS & no Sb/Br) - please check <http://www.ti.com/productcontent> for the latest availability information and additional product content details.

**TBD:** The Pb-Free/Green conversion plan has not been defined.

**Pb-Free (RoHS):** TI's terms "Lead-Free" or "Pb-Free" mean semiconductor products that are compatible with the current RoHS requirements for all 6 substances, including the requirement that lead not exceed 0.1% by weight in homogeneous materials. Where designed to be soldered at high temperatures, TI Pb-Free products are suitable for use in specified lead-free processes.

**Pb-Free (RoHS Exempt):** This component has a RoHS exemption for either 1) lead-based flip-chip solder bumps used between the die and package, or 2) lead-based die adhesive used between the die and leadframe. The component is otherwise considered Pb-Free (RoHS compatible) as defined above.

**Green (RoHS & no Sb/Br):** TI defines "Green" to mean Pb-Free (RoHS compatible), and free of Bromine (Br) and Antimony (Sb) based flame retardants (Br or Sb do not exceed 0.1% by weight in homogeneous material)

(3) MSL, Peak Temp. - The Moisture Sensitivity Level rating according to the JEDEC industry standard classifications, and peak solder temperature.

(4) There may be additional marking, which relates to the logo, the lot trace code information, or the environmental category on the device.

(5) Multiple Device Markings will be inside parentheses. Only one Device Marking contained in parentheses and separated by a "~" will appear on a device. If a line is indented then it is a continuation of the previous line and the two combined represent the entire Device Marking for that device.

(6) Lead/Ball Finish - Orderable Devices may have multiple material finish options. Finish options are separated by a vertical ruled line. Lead/Ball Finish values may wrap to two lines if the finish value exceeds the maximum column width.

**Important Information and Disclaimer:** The information provided on this page represents TI's knowledge and belief as of the date that it is provided. TI bases its knowledge and belief on information provided by third parties, and makes no representation or warranty as to the accuracy of such information. Efforts are underway to better integrate information from third parties. TI has taken and

continues to take reasonable steps to provide representative and accurate information but may not have conducted destructive testing or chemical analysis on incoming materials and chemicals. TI and TI suppliers consider certain information to be proprietary, and thus CAS numbers and other limited information may not be available for release.

In no event shall TI's liability arising out of such information exceed the total purchase price of the TI part(s) at issue in this document sold by TI to Customer on an annual basis.

**OTHER QUALIFIED VERSIONS OF LMV341, LMV344 :**

- Automotive: [LMV341-Q1](#), [LMV344-Q1](#)

**NOTE: Qualified Version Definitions:**

- Automotive - Q100 devices qualified for high-reliability automotive applications targeting zero defects

**TAPE AND REEL INFORMATION**

**QUADRANT ASSIGNMENTS FOR PIN 1 ORIENTATION IN TAPE**

\*All dimensions are nominal

| Device      | Package Type | Package Drawing | Pins | SPQ  | Reel Diameter (mm) | Reel Width W1 (mm) | A0 (mm) | B0 (mm) | K0 (mm) | P1 (mm) | W (mm) | Pin1 Quadrant |
|-------------|--------------|-----------------|------|------|--------------------|--------------------|---------|---------|---------|---------|--------|---------------|
| LMV341IDBVR | SOT-23       | DBV             | 6    | 3000 | 180.0              | 8.4                | 3.23    | 3.17    | 1.37    | 4.0     | 8.0    | Q3            |
| LMV341IDCKR | SC70         | DCK             | 6    | 3000 | 180.0              | 8.4                | 2.41    | 2.41    | 1.2     | 4.0     | 8.0    | Q3            |
| LMV342IDGKR | VSSOP        | DGK             | 8    | 2500 | 330.0              | 12.4               | 5.3     | 3.4     | 1.4     | 8.0     | 12.0   | Q1            |
| LMV342IDR   | SOIC         | D               | 8    | 2500 | 330.0              | 12.4               | 6.4     | 5.2     | 2.1     | 8.0     | 12.0   | Q1            |
| LMV344IDR   | SOIC         | D               | 14   | 2500 | 330.0              | 16.4               | 6.5     | 9.0     | 2.1     | 8.0     | 16.0   | Q1            |
| LMV344IPWR  | TSSOP        | PW              | 14   | 2000 | 330.0              | 12.4               | 6.9     | 5.6     | 1.6     | 8.0     | 12.0   | Q1            |

## TAPE AND REEL BOX DIMENSIONS



\*All dimensions are nominal

| Device      | Package Type | Package Drawing | Pins | SPQ  | Length (mm) | Width (mm) | Height (mm) |
|-------------|--------------|-----------------|------|------|-------------|------------|-------------|
| LMV341IDBVR | SOT-23       | DBV             | 6    | 3000 | 202.0       | 201.0      | 28.0        |
| LMV341IDCKR | SC70         | DCK             | 6    | 3000 | 202.0       | 201.0      | 28.0        |
| LMV342IDGKR | VSSOP        | DGK             | 8    | 2500 | 358.0       | 335.0      | 35.0        |
| LMV342IDR   | SOIC         | D               | 8    | 2500 | 340.5       | 338.1      | 20.6        |
| LMV344IDR   | SOIC         | D               | 14   | 2500 | 367.0       | 367.0      | 38.0        |
| LMV344IPWR  | TSSOP        | PW              | 14   | 2000 | 367.0       | 367.0      | 35.0        |

# MECHANICAL DATA

DBV (R-PDSO-G6)

PLASTIC SMALL-OUTLINE PACKAGE

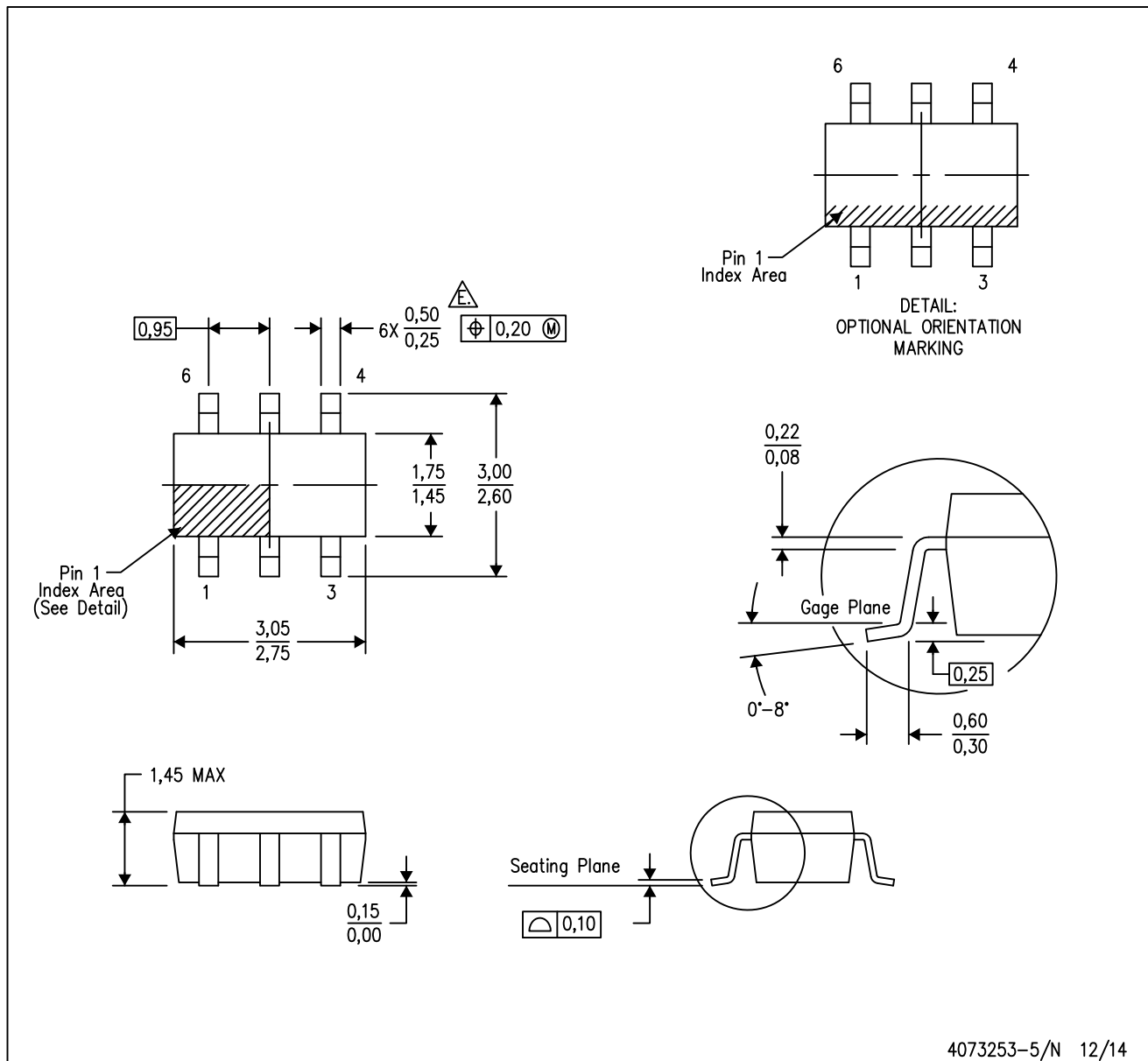

- NOTES:
- A. All linear dimensions are in millimeters.
  - B. This drawing is subject to change without notice.
  - C. Body dimensions do not include mold flash or protrusion. Mold flash and protrusion shall not exceed 0.15 per side.
  - D. Leads 1,2,3 may be wider than leads 4,5,6 for package orientation.
-  Falls within JEDEC MO-178 Variation AB, except minimum lead width.



DBV (R-PDSO-G6)

PLASTIC SMALL OUTLINE

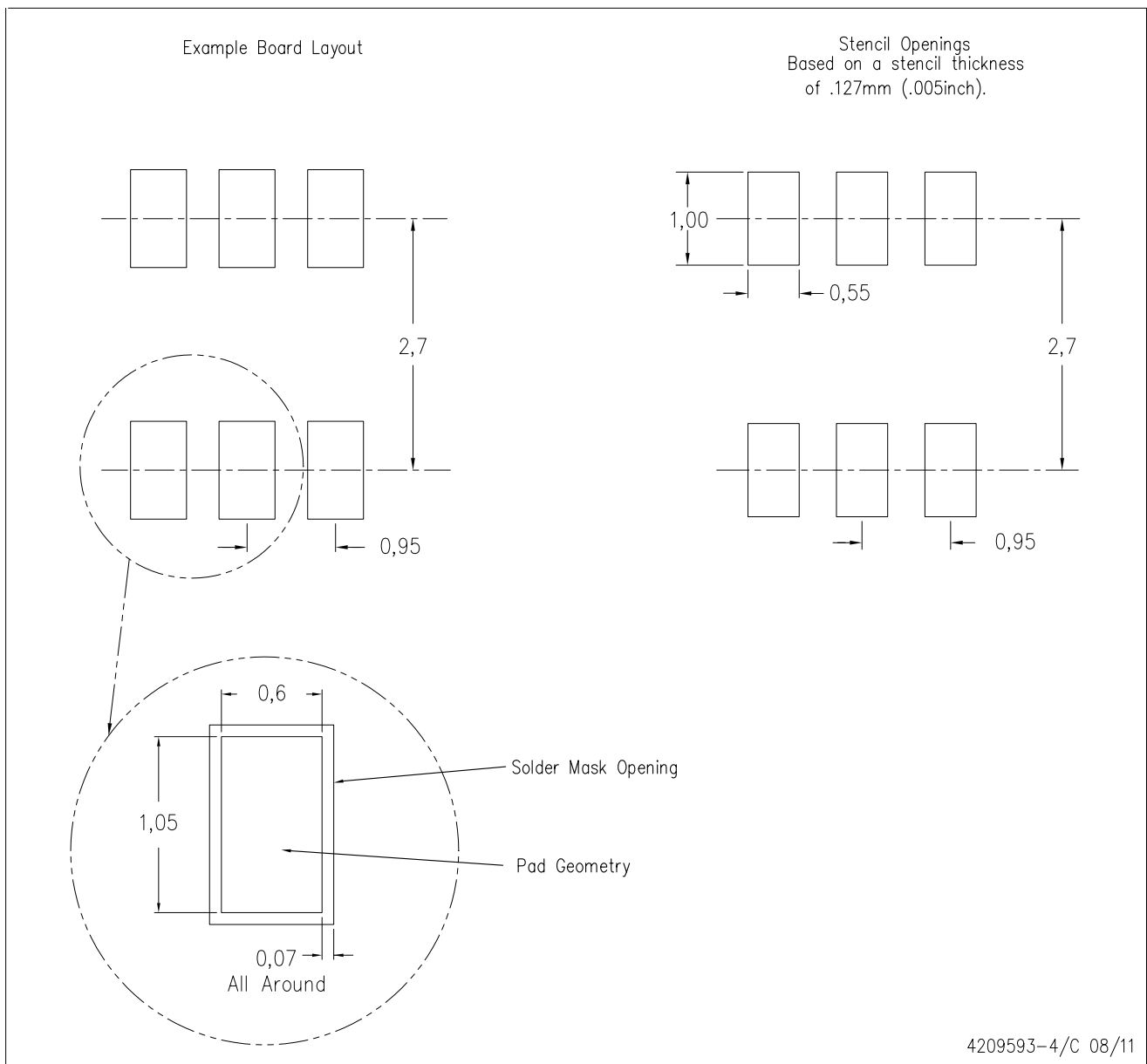

- NOTES:
- A. All linear dimensions are in millimeters.
  - B. This drawing is subject to change without notice.
  - C. Customers should place a note on the circuit board fabrication drawing not to alter the center solder mask defined pad.
  - D. Publication IPC-7351 is recommended for alternate designs.
  - E. Laser cutting apertures with trapezoidal walls and also rounding corners will offer better paste release. Customers should contact their board assembly site for stencil design recommendations. Example stencil design based on a 50% volumetric metal load solder paste. Refer to IPC-7525 for other stencil recommendations.

DGK (S-PDSO-G8)

PLASTIC SMALL-OUTLINE PACKAGE



- NOTES:
- A. All linear dimensions are in millimeters.
  - B. This drawing is subject to change without notice.
  - C. Body length does not include mold flash, protrusions, or gate burrs. Mold flash, protrusions, or gate burrs shall not exceed 0.15 per end.
  - D. Body width does not include interlead flash. Interlead flash shall not exceed 0.50 per side.
  - E. Falls within JEDEC MO-187 variation AA, except interlead flash.

DCK (R-PDSO-G6)

PLASTIC SMALL-OUTLINE PACKAGE



- NOTES:
- A. All linear dimensions are in millimeters.
  - B. This drawing is subject to change without notice.
  - C. Body dimensions do not include mold flash or protrusion. Mold flash and protrusion shall not exceed 0.15 per side.
  - D. Falls within JEDEC MO-203 variation AB.

DCK (R-PDSO-G6)

PLASTIC SMALL OUTLINE



- NOTES:
- All linear dimensions are in millimeters.
  - This drawing is subject to change without notice.
  - Customers should place a note on the circuit board fabrication drawing not to alter the center solder mask defined pad.
  - Publication IPC-7351 is recommended for alternate designs.
  - Laser cutting apertures with trapezoidal walls and also rounding corners will offer better paste release. Customers should contact their board assembly site for stencil design recommendations. Example stencil design based on a 50% volumetric metal load solder paste. Refer to IPC-7525 for other stencil recommendations.

D (R-PDSO-G14)

PLASTIC SMALL OUTLINE



- NOTES:
- A. All linear dimensions are in inches (millimeters).
  - B. This drawing is subject to change without notice.
  - Body length does not include mold flash, protrusions, or gate burrs. Mold flash, protrusions, or gate burrs shall not exceed 0.006 (0,15) each side.
  - Body width does not include interlead flash. Interlead flash shall not exceed 0.017 (0,43) each side.
  - E. Reference JEDEC MS-012 variation AB.

D (R-PDSO-G14)

PLASTIC SMALL OUTLINE



- NOTES:
- All linear dimensions are in millimeters.
  - This drawing is subject to change without notice.
  - Publication IPC-7351 is recommended for alternate designs.
  - Laser cutting apertures with trapezoidal walls and also rounding corners will offer better paste release. Customers should contact their board assembly site for stencil design recommendations. Refer to IPC-7525 for other stencil recommendations.
  - Customers should contact their board fabrication site for solder mask tolerances between and around signal pads.

PW (R-PDSO-G14)

PLASTIC SMALL OUTLINE

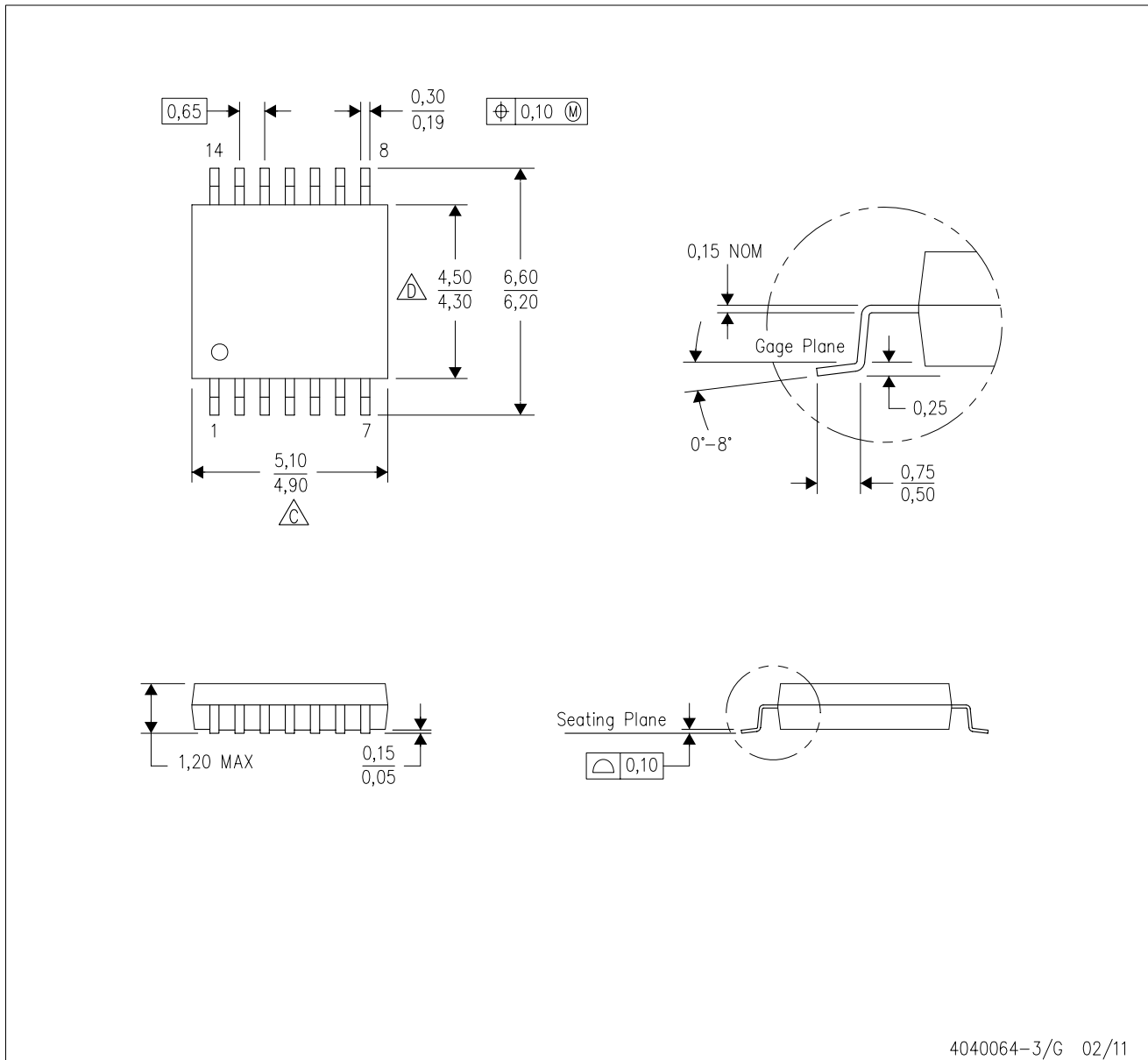

- NOTES:
- A. All linear dimensions are in millimeters. Dimensioning and tolerancing per ASME Y14.5M-1994.
  - B. This drawing is subject to change without notice.
  - C. Body length does not include mold flash, protrusions, or gate burrs. Mold flash, protrusions, or gate burrs shall not exceed 0,15 each side.
  - D. Body width does not include interlead flash. Interlead flash shall not exceed 0,25 each side.
  - E. Falls within JEDEC MO-153

PW (R-PDSO-G14)

PLASTIC SMALL OUTLINE



- NOTES:
- All linear dimensions are in millimeters.
  - This drawing is subject to change without notice.
  - Publication IPC-7351 is recommended for alternate designs.
  - Laser cutting apertures with trapezoidal walls and also rounding corners will offer better paste release. Customers should contact their board assembly site for stencil design recommendations. Refer to IPC-7525 for other stencil recommendations.
  - Customers should contact their board fabrication site for solder mask tolerances between and around signal pads.



D (R-PDSO-G8)

PLASTIC SMALL OUTLINE



NOTES: A. All linear dimensions are in inches (millimeters).  
 B. This drawing is subject to change without notice.  
 C. Body length does not include mold flash, protrusions, or gate burrs. Mold flash, protrusions, or gate burrs shall not exceed 0.006 (0,15) each side.  
 D. Body width does not include interlead flash. Interlead flash shall not exceed 0.017 (0,43) each side.  
 E. Reference JEDEC MS-012 variation AA.

D (R-PDSO-G8)

PLASTIC SMALL OUTLINE



- NOTES:
- All linear dimensions are in millimeters.
  - This drawing is subject to change without notice.
  - Publication IPC-7351 is recommended for alternate designs.
  - Laser cutting apertures with trapezoidal walls and also rounding corners will offer better paste release. Customers should contact their board assembly site for stencil design recommendations. Refer to IPC-7525 for other stencil recommendations.
  - Customers should contact their board fabrication site for solder mask tolerances between and around signal pads.

## IMPORTANT NOTICE

Texas Instruments Incorporated and its subsidiaries (TI) reserve the right to make corrections, enhancements, improvements and other changes to its semiconductor products and services per JESD46, latest issue, and to discontinue any product or service per JESD48, latest issue. Buyers should obtain the latest relevant information before placing orders and should verify that such information is current and complete. All semiconductor products (also referred to herein as "components") are sold subject to TI's terms and conditions of sale supplied at the time of order acknowledgment.

TI warrants performance of its components to the specifications applicable at the time of sale, in accordance with the warranty in TI's terms and conditions of sale of semiconductor products. Testing and other quality control techniques are used to the extent TI deems necessary to support this warranty. Except where mandated by applicable law, testing of all parameters of each component is not necessarily performed.

TI assumes no liability for applications assistance or the design of Buyers' products. Buyers are responsible for their products and applications using TI components. To minimize the risks associated with Buyers' products and applications, Buyers should provide adequate design and operating safeguards.

TI does not warrant or represent that any license, either express or implied, is granted under any patent right, copyright, mask work right, or other intellectual property right relating to any combination, machine, or process in which TI components or services are used. Information published by TI regarding third-party products or services does not constitute a license to use such products or services or a warranty or endorsement thereof. Use of such information may require a license from a third party under the patents or other intellectual property of the third party, or a license from TI under the patents or other intellectual property of TI.

Reproduction of significant portions of TI information in TI data books or data sheets is permissible only if reproduction is without alteration and is accompanied by all associated warranties, conditions, limitations, and notices. TI is not responsible or liable for such altered documentation. Information of third parties may be subject to additional restrictions.

Resale of TI components or services with statements different from or beyond the parameters stated by TI for that component or service voids all express and any implied warranties for the associated TI component or service and is an unfair and deceptive business practice. TI is not responsible or liable for any such statements.

Buyer acknowledges and agrees that it is solely responsible for compliance with all legal, regulatory and safety-related requirements concerning its products, and any use of TI components in its applications, notwithstanding any applications-related information or support that may be provided by TI. Buyer represents and agrees that it has all the necessary expertise to create and implement safeguards which anticipate dangerous consequences of failures, monitor failures and their consequences, lessen the likelihood of failures that might cause harm and take appropriate remedial actions. Buyer will fully indemnify TI and its representatives against any damages arising out of the use of any TI components in safety-critical applications.

In some cases, TI components may be promoted specifically to facilitate safety-related applications. With such components, TI's goal is to help enable customers to design and create their own end-product solutions that meet applicable functional safety standards and requirements. Nonetheless, such components are subject to these terms.

No TI components are authorized for use in FDA Class III (or similar life-critical medical equipment) unless authorized officers of the parties have executed a special agreement specifically governing such use.

Only those TI components which TI has specifically designated as military grade or "enhanced plastic" are designed and intended for use in military/aerospace applications or environments. Buyer acknowledges and agrees that any military or aerospace use of TI components which have **not** been so designated is solely at the Buyer's risk, and that Buyer is solely responsible for compliance with all legal and regulatory requirements in connection with such use.

TI has specifically designated certain components as meeting ISO/TS16949 requirements, mainly for automotive use. In any case of use of non-designated products, TI will not be responsible for any failure to meet ISO/TS16949.

### Products

|                              |  |
|------------------------------|--|
| Audio                        | <a href="http://www.ti.com/audio">www.ti.com/audio</a>                               |
| Amplifiers                   | <a href="http://amplifier.ti.com">amplifier.ti.com</a>                               |
| Data Converters              | <a href="http://dataconverter.ti.com">dataconverter.ti.com</a>                       |
| DLP® Products                | <a href="http://www.dlp.com">www.dlp.com</a>   |
| DSP                          | <a href="http://dsp.ti.com">dsp.ti.com</a>   |
| Clocks and Timers            | <a href="http://www.ti.com/clocks">www.ti.com/clocks</a>                             |
| Interface                    | <a href="http://interface.ti.com">interface.ti.com</a>                               |
| Logic                        | <a href="http://logic.ti.com">logic.ti.com</a>                                       |
| Power Mgmt                   | <a href="http://power.ti.com">power.ti.com</a>                                       |
| Microcontrollers             | <a href="http://microcontroller.ti.com">microcontroller.ti.com</a>                   |
| RFID                         | <a href="http://www.ti-rfid.com">www.ti-rfid.com</a>                                 |
| OMAP Applications Processors | <a href="http://www.ti.com/omap">www.ti.com/omap</a>                                 |
| Wireless Connectivity        | <a href="http://www.ti.com/wirelessconnectivity">www.ti.com/wirelessconnectivity</a> |

### Applications

|                               |  |
|-------------------------------|--|
| Automotive and Transportation | <a href="http://www.ti.com/automotive">www.ti.com/automotive</a>                         |
| Communications and Telecom    | <a href="http://www.ti.com/communications">www.ti.com/communications</a>                 |
| Computers and Peripherals     | <a href="http://www.ti.com/computers">www.ti.com/computers</a>                           |
| Consumer Electronics          | <a href="http://www.ti.com/consumer-apps">www.ti.com/consumer-apps</a>                   |
| Energy and Lighting           | <a href="http://www.ti.com/energy">www.ti.com/energy</a>                                 |
| Industrial                    | <a href="http://www.ti.com/industrial">www.ti.com/industrial</a>                         |
| Medical                       | <a href="http://www.ti.com/medical">www.ti.com/medical</a>                               |
| Security                      | <a href="http://www.ti.com/security">www.ti.com/security</a>                             |
| Space, Avionics and Defense   | <a href="http://www.ti.com/space-avionics-defense">www.ti.com/space-avionics-defense</a> |
| Video and Imaging             | <a href="http://www.ti.com/video">www.ti.com/video</a>                                   |

### TI E2E Community

[e2e.ti.com](http://e2e.ti.com)