

## 100-W 48-V INPUT ISOLATED DC/DC CONVERTER

Check for Samples: [PTQA430025](#), [PTQA430033](#), [PTQA420050](#)

### FEATURES

- 100-W Output
- Input Voltage Range: 36 V to 75 V
- 92% Efficiency
- 1500 Vdc Isolation
- Fast Transient Response
- On/Off Control
- Overcurrent Protection
- Differential Remote Sense
- Adjustable Output Voltage
- Output Overvoltage Protection
- Over-Temperature Shutdown
- Undervoltage Lockout
- Standard 1/4-Brick Footprint
- UL Safety Agency Approval



### DESCRIPTION

The PTQA series of power modules are single-output isolated DC/DC converters, housed in an industry standard quarter-brick package. These modules are rated up to 100W with a maximum load current of up to 30 A.

The PTQA series operates from a standard 48-V telecom central office (CO) supply and occupies only 3.3 in<sup>2</sup> of PCB area. The modules offer OEMs a compact and flexible high-output power source in an industry standard footprint. They are suitable for distributed power applications in both telecom and computing environments, and may be used for powering high-end microprocessors, DSPs, general purpose logic and analog.

Features include a remote On/Off control with optional logic polarity, an undervoltage lockout (UVLO), a differential remote sense, and an industry standard output voltage adjustment using an external resistor. Protection features include output overcurrent protection (OCP), overvoltage protection (OVP), and thermal shutdown (OTP).

The modules are fully integrated for stand-alone operation, and require no additional components.

### STANDARD APPLICATION

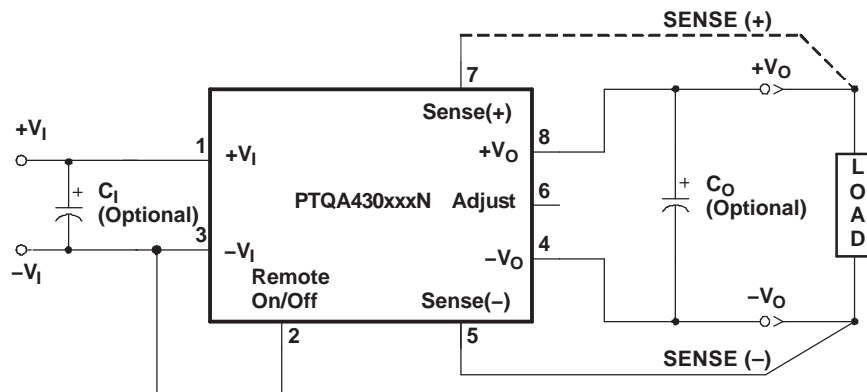

Please be aware that an important notice concerning availability, standard warranty, and use in critical applications of Texas Instruments semiconductor products and disclaimers thereto appears at the end of this data sheet.



This integrated circuit can be damaged by ESD. Texas Instruments recommends that all integrated circuits be handled with appropriate precautions. Failure to observe proper handling and installation procedures can cause damage.

ESD damage can range from subtle performance degradation to complete device failure. Precision integrated circuits may be more susceptible to damage because very small parametric changes could cause the device not to meet its published specifications.

### ORDERING INFORMATION

For the most current package and ordering information, see the Package Option Addendum at the end of this datasheet, or see the TI website at [www.ti.com](http://www.ti.com).

**Table 1. PART NUMBERING SCHEME**

	Input Voltage	Output Current	Output Voltage	Enable	Electrical Options		Pin Style
<b>PTQA</b>	<b>4</b>	<b>30</b>	<b>033</b>	<b>N</b>	<b>2</b>	<b>A</b>	<b>D</b>
	4 = 48 V	30 = 30A 20 = 20A	025 = 2.5 V 033 = 3.3 V 050 = 5.0 V	N = Negative P = Positive	2 = V <sub>O</sub> Adjust		D = Through-hole, Pb-free S = SMD, SnPb solder ball Z = SMD, SnAgCu solder ball

### ABSOLUTE MAXIMUM RATING

		UNIT
T <sub>A</sub>	Operating Temperature Range	Over V <sub>I</sub> Range –40°C to 85°C <sup>(1)</sup>
V <sub>I, MAX</sub>	Maximum Input Voltage	Continuous voltage Peak voltage for 100 ms duration 80 V 100 V
P <sub>O, MAX</sub>	Maximum Output Power	PTQA420050x2 PTQA430033x2 PTQA430025x2 100 W 75 W
T <sub>S</sub>	Storage Temperature	–40°C to 125°C
	Mechanical Shock	Per Mil-STD-883, Method 2002.3 1 ms, 1/2 Sine, mounted AD Suffix AS or AZ Suffix 250 G 175 G
	Mechanical Vibration	Per Mil-STD-883, Method 2007.2 20-2000 Hz, PCB mounted AD Suffix AS or AZ Suffix 15 G 2.5 G
	Weight	30 grams
	Flammability	Meets UL 94V-O

(1) See SOA curves or consult factory for appropriate derating.

**ELECTRICAL CHARACTERISTICS PTQA430025**

(Unless otherwise stated,  $T_A = 25^\circ\text{C}$ ,  $V_I = 48\text{ V}$ ,  $V_O = 2.5\text{ V}$ ,  $C_O = 0\ \mu\text{F}$ , and  $I_O = I_{O\text{max}}$ )

PARAMETER		TEST CONDITIONS	PTQA430025			
			MIN	TYP	MAX	UNIT
$I_O$	Output Current	Over $V_I$ range	0		30	A
$V_I$	Input Voltage Range	Over $I_O$ Range	36	48	75	V
$V_O$ tol	Set Point Voltage Tolerance		$\pm 1^{(1)}$			$\%V_O$
$\text{Reg}_{\text{temp}}$	Temperature Variation	$-40^\circ\text{C} > T_A > 85^\circ\text{C}$	$\pm 1.15$			$\%V_O$
$\text{Reg}_{\text{line}}$	Line Regulation	Over $V_I$ range	$\pm 5$			mV
$\text{Reg}_{\text{load}}$	Load Regulation	Over $I_O$ range	$\pm 5$			mV
$\Delta V_{O\text{tot}}$	Total Output Voltage Variation	Includes set-point, line, load, $-40^\circ\text{C} > T_A > 85^\circ\text{C}$	$\pm 1.5$		$\pm 3$	$\%V_O$
$\Delta V_{\text{ADJ}}$	Output Adjust Range	$P_O \leq 75\text{ W}$	-20		10	$\%V_O$
$\eta$	Efficiency	$I_O = 50\% I_{O\text{max}}$	91%			
$V_R$	$V_O$ Ripple (pk-pk)	20 MHz bandwidth		50	100	mV <sub>pp</sub>
$t_{\text{tr}}$	Transient Response	0.1 A/ $\mu\text{s}$ slew rate, 50% to 75% $I_{O\text{max}}$	150			$\mu\text{s}$
$\Delta V_{\text{tr}}$		$V_O$ over/undershoot	25			mV
$I_{\text{TRIP}}$	Overcurrent Threshold	Shutdown, followed by auto-recovery	41			A
OVP	Output Overvoltage Protection	Output shutdown and latch off	120			$\%V_O$
OTP	Over Temperature Protection	Temperature Measurement at thermal sensor. Hysteresis = $10^\circ\text{C}$ nominal.	105			$^\circ\text{C}$
$f_s$	Switching Frequency	Over $V_I$ range	300			kHz
UVLO	Undervoltage Lockout	$V_{\text{OFF}}$ $V_{\text{HYS}}$	$V_I$ decreasing, $I_O = 6\text{ A}$ Hysteresis		32.5 1.5	V
On/Off Input: <b>Negative Enable</b>						
$V_{\text{IH}}$	Input High Voltage	Referenced to $-V_I$	2.4	Open <sup>(2)</sup>		V
$V_{\text{IL}}$	Input Low Voltage		-0.2	0.8		
$I_{\text{IL}}$	Input Low Current		-0.3			mA
On/Off Input: <b>Positive Enable</b>						
$V_{\text{IH}}$	Input High Voltage	Referenced to $-V_I$	4.5	Open <sup>(2)</sup>		V
$V_{\text{IL}}$	Input Low Voltage		-0.2	0.8		
$I_{\text{IL}}$	Input Low Current		-0.5			mA
$I_{\text{ISB}}$	Standby Input Current	Output disabled (pin 2 status set to Off)	37			mA
$C_I$	External Input Capacitance	Between $+V_I$ and $-V_I$	100			$\mu\text{F}$
$C_O$	External Output Capacitance	Between $+V_O$ and $-V_O$	0	30000		$\mu\text{F}$
	Isolation Voltage	Input-to-output and input-to-case	1500			Vdc
	Isolation Capacitance	Input-to-output	1200			pF
	Isolation Resistance	Input-to-output	10			M $\Omega$

(1) If Sense(-) is not used, pin 5 must be connected to pin 4 for optimum output voltage accuracy.

(2) The Remote On/Off input has an internal pull-up and may be controlled with an open collector (drain) interface. An open circuit correlates to a logic high. Consult the application notes for interface considerations.

### ELECTRICAL CHARACTERISTICS PTQA430033

(Unless otherwise stated,  $T_A = 25^\circ\text{C}$ ,  $V_I = 48\text{ V}$ ,  $V_O = 3.3\text{ V}$ ,  $C_O = 0\text{ }\mu\text{F}$ , and  $I_O = I_{Omax}$ )

PARAMETER		TEST CONDITIONS	PTQA430033			
			MIN	TYP	MAX	UNIT
$I_O$	Output Current	Over $V_I$ range	0		30	A
$V_I$	Input Voltage Range	Over $I_O$ Range	36	48	75	V
$V_O$ tol	Set Point Voltage Tolerance		$\pm 1^{(1)}$			$\%V_O$
$Reg_{temp}$	Temperature Variation	$-40^\circ\text{C} > T_A > 85^\circ\text{C}$	$\pm 1.15$			$\%V_O$
$Reg_{line}$	Line Regulation	Over $V_I$ range	$\pm 5$			mV
$Reg_{load}$	Load Regulation	Over $I_O$ range	$\pm 5$			mV
$\Delta V_{Otot}$	Total Output Voltage Variation	Includes set-point, line, load, $-40^\circ\text{C} > T_A > 85^\circ\text{C}$	$\pm 1.5$		$\pm 3$	$\%V_O$
$\Delta V_{ADJ}$	Output Adjust Range	$P_O \leq 100\text{ W}$	-20		10	$\%V_O$
$\eta$	Efficiency	$I_O = 50\% I_{Omax}$	92%			
$V_R$	$V_O$ Ripple (pk-pk)	20 MHz bandwidth		50	100	mV <sub>pp</sub>
$t_{tr}$	Transient Response	0.1 A/ $\mu\text{s}$ slew rate, 50% to 75% $I_{Omax}$	150			$\mu\text{s}$
$\Delta V_{tr}$		$V_O$ over/undershoot	33			mV
$I_{TRIP}$	Overcurrent Threshold	Shutdown, followed by auto-recovery	41			A
OVP	Output Overvoltage Protection	Output shutdown and latch off	120			$\%V_O$
OTP	Over Temperature Protection	Temperature Measurement at thermal sensor. Hysteresis = $10^\circ\text{C}$ nominal.	105			$^\circ\text{C}$
$f_s$	Switching Frequency	Over $V_I$ range	300			kHz
UVLO	Undervoltage Lockout	$V_{OFF}$ $V_{HYS}$	$V_I$ decreasing, $I_O = 6\text{ A}$ Hysteresis		32.5 1.5	V
On/Off Input: <b>Negative Enable</b>		Referenced to $-V_I$	2.4		Open <sup>(2)</sup>	V
$V_{IH}$	Input High Voltage		-0.2		0.8	
$V_{IL}$	Input Low Voltage		-0.3			
$I_{IL}$	Input Low Current					mA
On/Off Input: <b>Positive Enable</b>		Referenced to $-V_I$	4.5		Open <sup>(2)</sup>	V
$V_{IH}$	Input High Voltage		-0.2		0.8	
$V_{IL}$	Input Low Voltage		-0.5			
$I_{IL}$	Input Low Current					mA
$I_{isb}$	Standby Input Current	Output disabled (pin 2 status set to Off)	42			mA
$C_I$	External Input Capacitance	Between $+V_I$ and $-V_I$	100			$\mu\text{F}$
$C_O$	External Output Capacitance	Between $+V_O$ and $-V_O$	0		30000	$\mu\text{F}$
Isolation Voltage		Input-to-output and input-to-case	1500			Vdc
Isolation Capacitance		Input-to-output	1200			pF
Isolation Resistance		Input-to-output	10			M $\Omega$

- (1) If Sense(-) is not used, pin 5 must be connected to pin 4 for optimum output voltage accuracy.
- (2) The Remote On/Off input has an internal pull-up and may be controlled with an open collector (drain) interface. An open circuit correlates to a logic high. Consult the application notes for interface considerations.

**ELECTRICAL CHARACTERISTICS PTQA420050**

(Unless otherwise stated,  $T_A = 25^\circ\text{C}$ ,  $V_I = 48\text{ V}$ ,  $V_O = 5.0\text{ V}$ ,  $C_O = 0\text{ }\mu\text{F}$ , and  $I_O = I_{O\text{max}}$ )

PARAMETER		TEST CONDITIONS	PTQA420050			
			MIN	TYP	MAX	UNIT
$I_O$	Output Current	Over $V_I$ range	0		20	A
$V_I$	Input Voltage Range	Over $I_O$ Range	36	48	75	V
$V_O$ tol	Set Point Voltage Tolerance		$\pm 1^{(1)}$			$\%V_O$
$\text{Reg}_{\text{temp}}$	Temperature Variation	$-40^\circ\text{C} > T_A > 85^\circ\text{C}$	$\pm 1.15$			$\%V_O$
$\text{Reg}_{\text{line}}$	Line Regulation	Over $V_I$ range	$\pm 5$			mV
$\text{Reg}_{\text{load}}$	Load Regulation	Over $I_O$ range	$\pm 5$			mV
$\Delta V_{O\text{tot}}$	Total Output Voltage Variation	Includes set-point, line, load, $-40^\circ\text{C} > T_A > 85^\circ\text{C}$	$\pm 1.5$		$\pm 3$	$\%V_O$
$\Delta V_{\text{ADJ}}$	Output Adjust Range	$P_O \leq 100\text{ W}$	-20		10	$\%V_O$
$\eta$	Efficiency	$I_O = 50\% I_{O\text{max}}$	92.5%			
$V_R$	$V_O$ Ripple (pk-pk)	20 MHz bandwidth		50	100	mV <sub>pp</sub>
$t_{\text{tr}}$	Transient Response	0.1 A/ $\mu\text{s}$ slew rate, 50% to 75% $I_{O\text{max}}$	100			$\mu\text{s}$
$\Delta V_{\text{tr}}$		$V_O$ over/undershoot	50			mV
$I_{\text{TRIP}}$	Overcurrent Threshold	Shutdown, followed by auto-recovery	29			A
OVP	Output Overvoltage Protection	Output shutdown and latch off	120			$\%V_O$
OTP	Over Temperature Protection	Temperature Measurement at thermal sensor. Hysteresis = $10^\circ\text{C}$ nominal.	105			$^\circ\text{C}$
$f_s$	Switching Frequency	Over $V_I$ range	300			kHz
UVLO	Undervoltage Lockout	$V_{\text{OFF}}$ $V_{\text{HYS}}$	$V_I$ decreasing, $I_O = 6\text{ A}$ Hysteresis		32.5 1.5	V
On/Off Input: <b>Negative Enable</b>						
$V_{\text{IH}}$	Input High Voltage	Referenced to $-V_I$	2.4	Open <sup>(2)</sup>		V
$V_{\text{IL}}$	Input Low Voltage		-0.2	0.8		
$I_{\text{IL}}$	Input Low Current		-0.3			mA
On/Off Input: <b>Positive Enable</b>						
$V_{\text{IH}}$	Input High Voltage	Referenced to $-V_I$	4.5	Open <sup>(2)</sup>		V
$V_{\text{IL}}$	Input Low Voltage		-0.2	0.8		
$I_{\text{IL}}$	Input Low Current		-0.5			mA
$I_{\text{isb}}$	Standby Input Current	Output disabled (pin 2 status set to Off)	58			mA
$C_I$	External Input Capacitance	Between $+V_I$ and $-V_I$	100			$\mu\text{F}$
$C_O$	External Output Capacitance	Between $+V_O$ and $-V_O$	0	30000		$\mu\text{F}$
	Isolation Voltage	Input-to-output and input-to-case	1500			Vdc
	Isolation Capacitance	Input-to-output	1200			pF
	Isolation Resistance	Input-to-output	10			M $\Omega$

(1) If Sense(-) is not used, pin 5 must be connected to pin 4 for optimum output voltage accuracy.

(2) The Remote On/Off input has an internal pull-up and may be controlled with an open collector (drain) interface. An open circuit correlates to a logic high. Consult the application notes for interface considerations.

### PIN DESCRIPTIONS

**+V<sub>I</sub>:** The positive input for the module with respect to  $-V_I$ . When powering the module from a  $-48\text{-V}$  telecom central office supply, this input is connected to the primary system ground.

**$-V_I$ :** The negative input supply for the module, and the 0 VDC reference for the Remote On/Off input. When powering the module from a  $+48\text{-V}$  supply, this input is connected to the 48-V return.

**Remote On/Off:** This input controls the On/Off status of the output voltage. It is either driven low ( $-V_I$  potential), or left open-circuit. For units identified with the NEN option, applying a logic low to this pin will enable the output. And for units identified with the PEN option, the output will be disabled.

**V<sub>O</sub> Adjust:** Allows the output voltage to be trimmed by up or down between  $+10\%$  and  $-20\%$  of its nominal value. The adjustment method uses a single external resistor. Connecting the resistor between V<sub>O</sub> Adjust and  $-V_O$  adjusts the output voltage lower, and placing it between V<sub>O</sub> Adjust and  $+V_O$  adjusts the output higher. The calculations for the resistance value follows industry standard formulas. For further information consult the application note on output voltage adjustment.

**+V<sub>O</sub>:** The positive power output with respect to  $-V_O$ , which is DC isolated from the input supply pins. If a negative output voltage is desired,  $+V_O$  should be connected to the secondary circuit common and the output taken from  $-V_O$ .

**$-V_O$ :** The negative power output with respect to  $+V_O$ , which is DC isolated from the input supply pins. This output is normally connected to the secondary circuit common when a positive output voltage is desired.

**Sense(+):** Provides the converter with an output sense capability to regulate the set-point voltage directly at the load. When used with Sense(-), the regulation circuitry will compensate for voltage drop between the converter and the load. The pin may be left open circuit, but connecting it to  $+V_O$  improves load regulation.

**Sense(-):** Provides the converter with an output sense capability when used in conjunction with Sense(+) input. For optimum output voltage accuracy this pin should always be connected to  $-V_O$ .

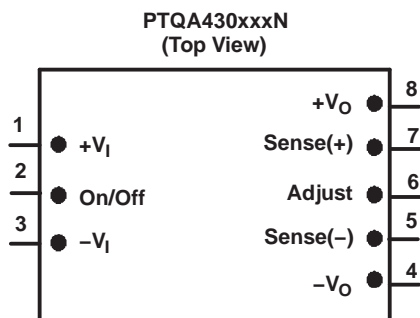

TYPICAL CHARACTERISTICS

PTQA430025,  $V_O = 2.5\text{ V}$  <sup>(1)</sup> <sup>(2)</sup>

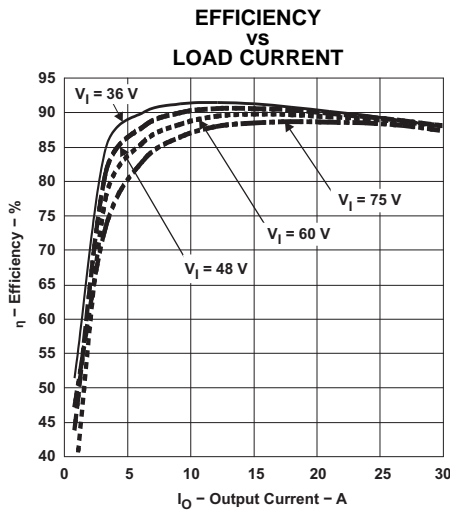

Figure 1.

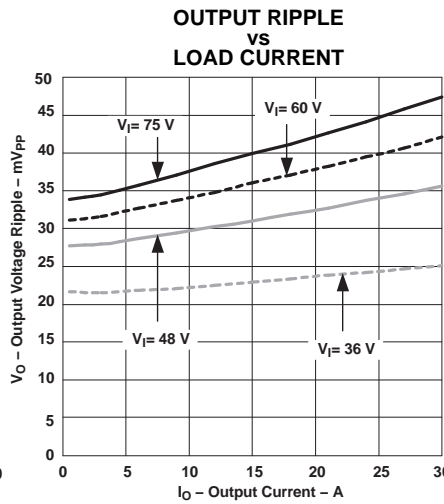

Figure 2.

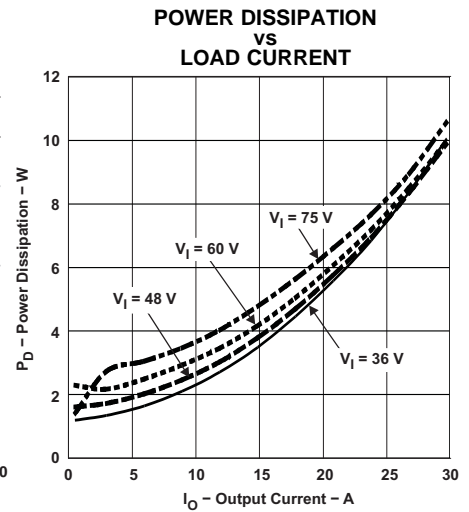

Figure 3.

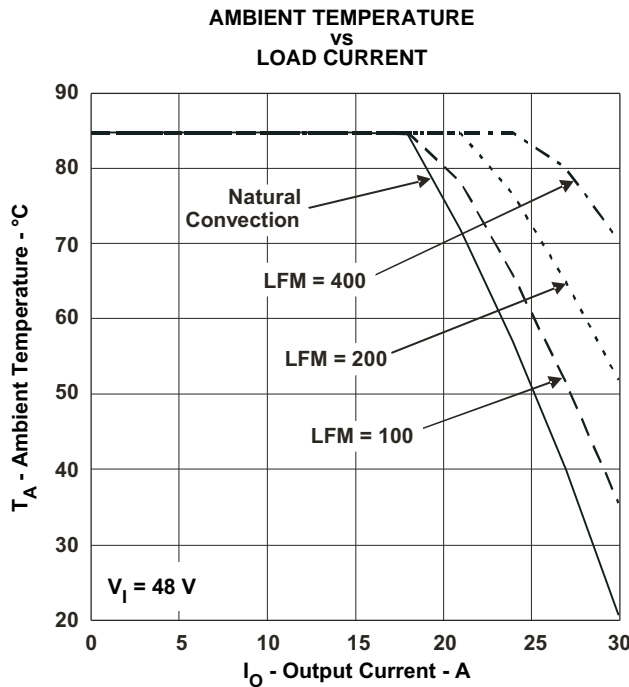

Figure 4.

- (1) All data listed in Figure 1, Figure 2, and Figure 3 have been developed from actual products tested at 25°C. This data is considered typical data for the dc-dc converter.
- (2) The temperature derating curves represent operating conditions at which internal components are at or below manufacturer's maximum rated operating temperature. Derating limits apply to modules soldered directly to a 100–mm x 100–mm, double-sided PCB with 2 oz. copper. For surface mount packages, multiple vias (plated through holes) are required to add thermal paths around the power pins. Please refer to the mechanical specification for more information. Applies to Figure 4.

TYPICAL CHARACTERISTICS

PTQA430033,  $V_O = 3.3\text{ V}$  (1) (2)

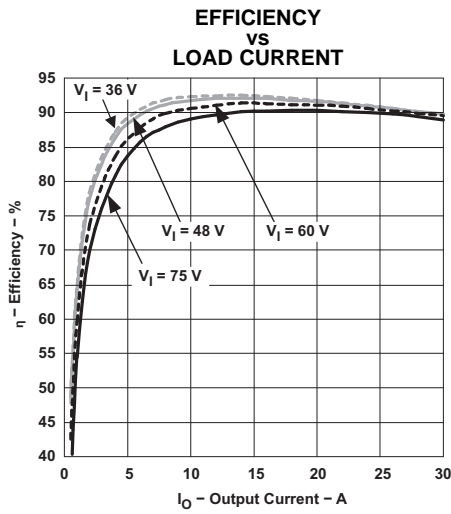

Figure 5.

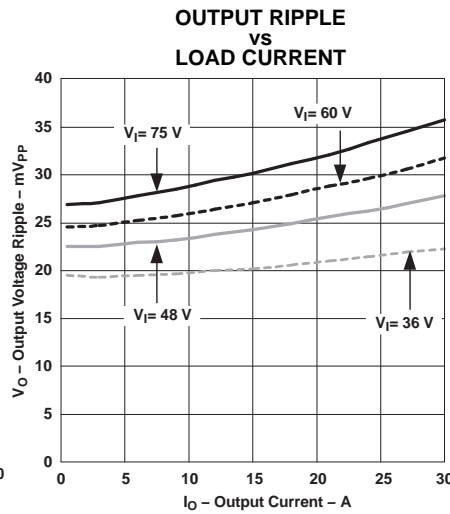

Figure 6.

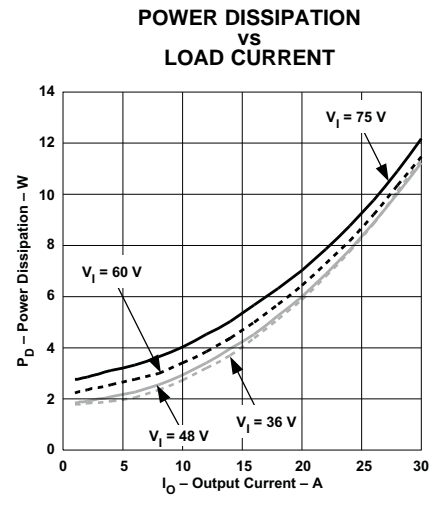

Figure 7.

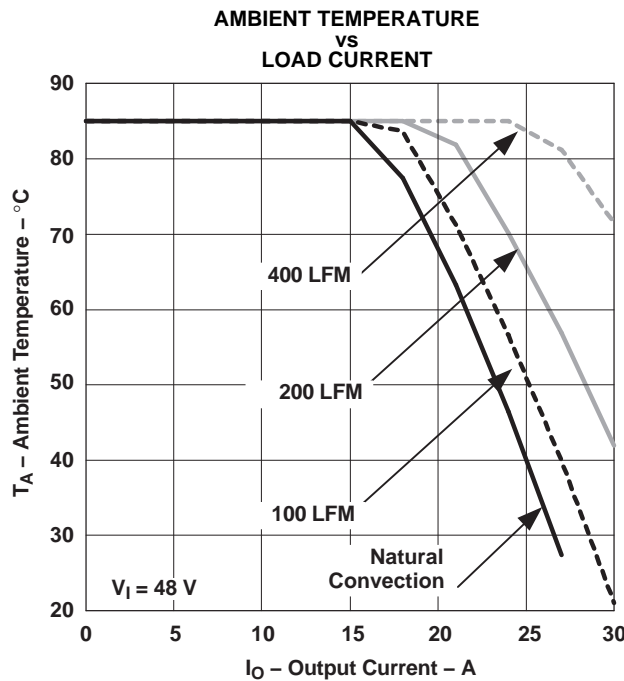

Figure 8.

- (1) All data listed in Figure 5, Figure 6, and Figure 7 have been developed from actual products tested at 25°C. This data is considered typical data for the dc-dc converter.
- (2) The temperature derating curves represent operating conditions at which internal components are at or below manufacturer's maximum rated operating temperature. Derating limits apply to modules soldered directly to a 100-mm x 100-mm, double-sided PCB with 2 oz. copper. For surface mount packages, multiple vias (plated through holes) are required to add thermal paths around the power pins. Please refer to the mechanical specification for more information. Applies to Figure 8.



TYPICAL CHARACTERISTICS

PTQA420050,  $V_O = 5.0\text{ V}$  (1) (2)

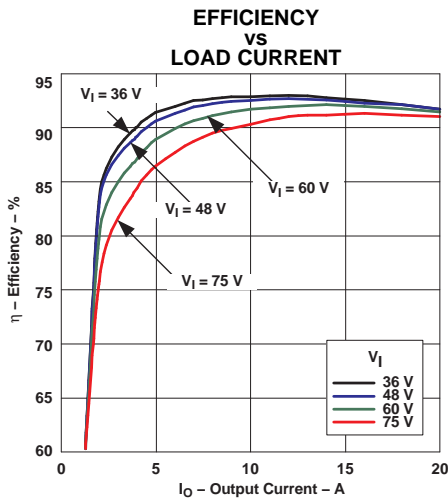

Figure 9.

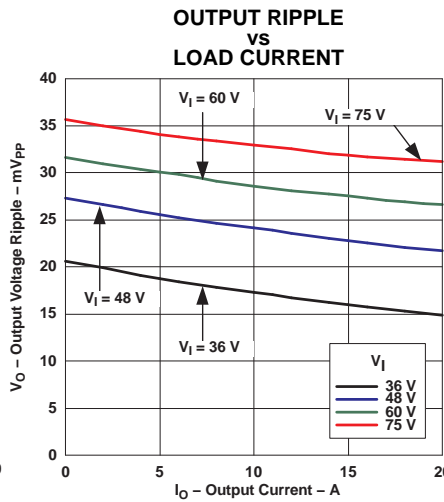

Figure 10.

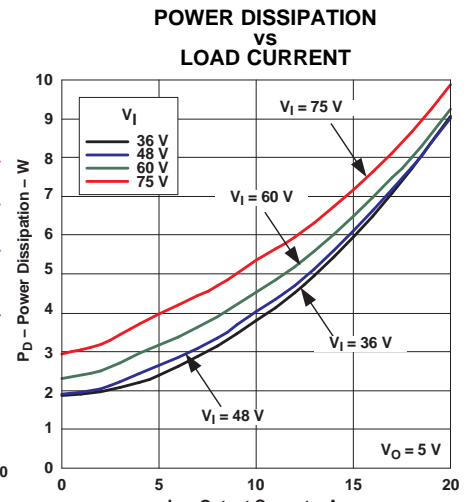

Figure 11.

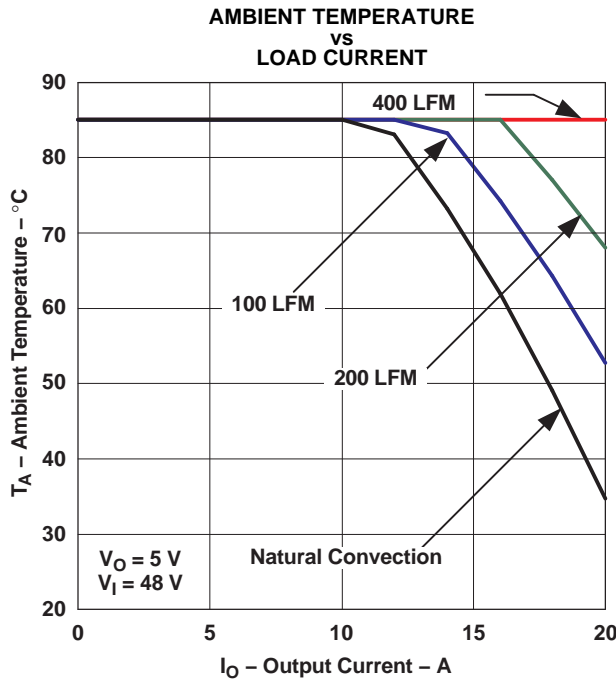

Figure 12.

- (1) All data listed in Figure 9, Figure 10, and Figure 11 have been developed from actual products tested at 25°C. This data is considered typical data for the dc-dc converter.
- (2) The temperature derating curves represent operating conditions at which internal components are at or below manufacturer's maximum rated operating temperature. Derating limits apply to modules soldered directly to a 100–mm x 100–mm, double-sided PCB with 2 oz. copper. For surface mount packages, multiple vias (plated through holes) are required to add thermal paths around the power pins. Please refer to the mechanical specification for more information. Applies to Figure 12.

## APPLICATION INFORMATION

### Operating Features and System Considerations for the PTQA Series of DC/DC Converters

#### Overcurrent Protection

To protect against load faults, these converters incorporate output overcurrent protection. Applying a load to the output that exceeds the converter's overcurrent threshold (see applicable specification) will cause the output voltage to momentarily fold back, and then shut down. Following shutdown the module will periodically attempt to automatically recover by initiating a soft-start power-up. This is often described as a *hiccup* mode of operation, whereby the module continues in the cycle of successive shutdown and power up until the load fault is removed. Once the fault is removed, the converter automatically recovers and returns to normal operation.

#### Output Overvoltage Protection

Each converter incorporates protection circuitry that continually senses for an output overvoltage (OV) condition. The OV threshold is set approximately 20% higher than the nominal output voltage. If the converter output voltage exceeds this threshold, the converter is immediately shut down and remains in a latched-off state. To resume normal operation the converter must be actively reset. This can only be done by momentarily removing the input power to the converter. For fail-safe operation and redundancy, the OV protection uses circuitry that is independent of the converter's internal feedback loop.

#### Overtemperature Protection

Overtemperature protection is provided by an internal temperature sensor, which closely monitors the temperature of the converter's printed circuit board (PCB). If the sensor exceeds a temperature of approximately 105°C, the converter will shut down. The converter will then automatically restart when the sensed temperature drops back to approximately 95°C. When operated outside its recommended thermal derating envelope (see data sheet SOA curves), the converter will typically cycle on and off at intervals from a few seconds to one or two minutes. This is to ensure that the internal components are not permanently damaged from excessive thermal stress.

#### Undervoltage Lockout

The Undervoltage lockout (UVLO) is designed to prevent the operation of the converter until the input voltage is at the minimum input voltage. This prevents high start-up current during normal power-up of the converter, and minimizes the current drain from the input source during low input voltage conditions. The UVLO circuitry also overrides the operation of the *Remote On/Off* control.

#### Primary-Secondary Isolation

These converters incorporate electrical isolation between the input terminals (primary) and the output terminals (secondary). All converters are production tested to a withstand voltage of 1500 VDC. This specification complies with UL60950 and EN60950 requirements. This allows the converter to be configured for either a positive or negative input voltage source. The data sheet *Pin Descriptions* section provides guidance as to the correct reference that must be used for the external control signals.

#### Input Current Limiting

The converter is not internally fused. For safety and overall system protection, the maximum input current to the converter must be limited. Active or passive current limiting can be used. Passive current limiting can be a fast acting fuse. A 125-V fuse, rated no more than 10 A, is recommended. Active current limiting can be implemented with a current limited *Hot-Swap* controller.

#### Thermal Considerations

Airflow may be necessary to ensure that the module can supply the desired load current in environments with elevated ambient temperatures. The required airflow rate may be determined from the Safe Operating Area (SOA) thermal derating chart (see typical characteristics).

### Differential Remote Sense

The remote sense pins allows the converter to precisely regulate the DC output voltage at a remote location. This might be a power plane on an inner layer of the host PCB. *Connecting Sense(+)* directly to  $+V_O$ , and *Sense(-)* to  $-V_O$  will improve output voltage accuracy. In the event that the sense pins are left open-circuit, an internal 10- $\Omega$  resistor between each sense pin and its corresponding output prevents an excessive rise in the output voltage. For practical reasons, the amount of IR voltage compensation should be limited to 0.5 V maximum.

The remote sense feature is designed to compensate for limited amounts of IR voltage drop. It is **not** intended to compensate for the forward drop of a non-linear or frequency dependent components that may be placed in series with the converter output. Examples of such components include OR-ing diodes, filter inductors, ferrite beads, and fuses. Enclosing these components with the remote sense connections effectively places them inside the regulation control loop, which can affect the stability of the regulator.

## Using the Remote On/Off Function on the PTQA Series of DC/DC Converters

For applications requiring output voltage On/Off control, the PTQA series of DC/DC converters incorporate a *Remote On/Off* control (pin 2). This feature can be used to switch the module off without removing the applied input source voltage. When placed in the *Off* state, the standby current drawn from the input source is typically reduced to 3 mA.

### Negative Output Enable (NEN)

Models using the negative enable option, the *Remote On/Off* (pin 2) control must be driven to a logic low voltage for the converter to produce an output. This is accomplished by either permanently connecting pin 2 to  $-V_I$  (pin 3), or driving it low with an external control signal. Table 2 shows the input requirements of pin 2 for those modules with the *NEN* option.

**Table 2. On/Off Control Requirements for Negative Enable**

PARAMETER		MIN	TYP	MAX
$V_{IH}$	Disable	2.4 V		20 V
$V_{IL}$	Enable	-0.2 V		0.8 V
$V_{o/c}$	Open-Circuit		9 V	15 V
$I_I$	Pin 2 at $-V_I$			-0.75 mA

### Positive Output Enable (PEN)

For those models with the positive enable (PEN) option, leaving pin 2 open circuit, (or driving it to an equivalent logic high voltage), will enable the converter output. This allows the module to produce an output voltage whenever a valid input source voltage is applied to  $+V_I$  with respect to  $-V_I$ . If a logic-low signal is then applied to pin 2 the converter output is disabled. Table 3 gives the input requirements of pin 2 for modules with the *PEN* option.

**Table 3. On/Off Control Requirements for Positive Enable**

PARAMETER		MIN	TYP	MAX
$V_{IH}$	Enable	4.5 V		20 V
$V_{IL}$	Disable	-0.2 V		0.8 V
$V_{o/c}$	Open-Circuit		5 V	7 V
$I_I$	Pin 2 at $-V_I$			-0.5 mA

#### Notes:

1. The *Remote On/Off* control uses  $-V_I$  (pin 3) as its ground reference. All voltages are with respect to  $-V_I$ .
2. An open-collector device (preferably a discrete transistor) is recommended. A pull-up resistor is not required. If one is added the pull-up voltage should not exceed 20 V.

**Caution:** Do not use a pull-resistor to  $+V_I$  (pin 1). The remote On/Off control has a maximum input voltage of 20 V. Exceeding this voltage will overstress, and possibly damage, the converter.

3. The *Remote On/Off* pin may be controlled with devices that have a totem-pole output. This is provided the output high level voltage ( $V_{OH}$ ) meets the module's minimum  $V_{IH}$  specified in Table 2. If a TTL gate is used, a pull-up resistor may be required to the logic supply voltage.
4. The converter incorporates an *undervoltage lockout* (UVLO). The UVLO keeps the converter off until the input voltage is close to the minimum specified operating voltage. This is regardless of the state of the *Remote On/Off* control. Consult the product specification for the UVLO input voltage thresholds.

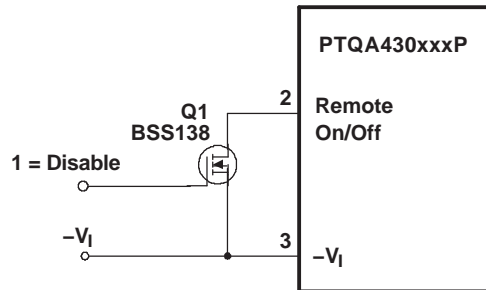
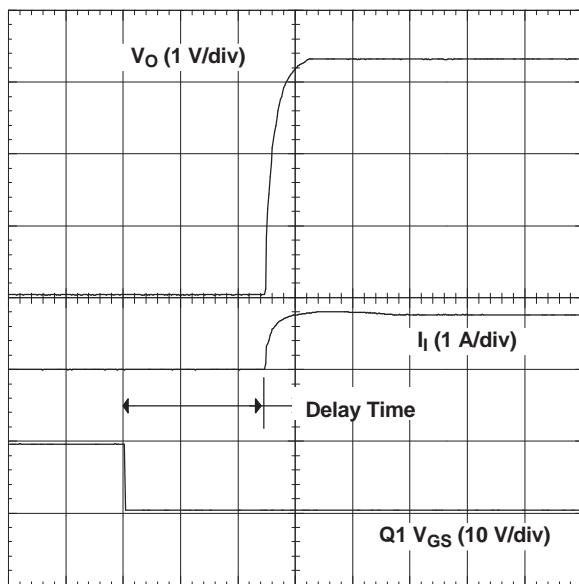

Figure 13. Recommended Control or Remote On/Off Input

**Turn-On:** With a valid input source voltage applied, the converter produces a regulated output voltage within 75 ms of the output being enabled. Figure 14 shows the output response of the PTQA430033P following the removal of the logic-low signal from the *Remote On/Off* (pin 2); see Figure 13. This corresponds to the drop in Q1  $V_{GS}$  in Figure 14. Although the rise-time of the output voltage is short (<10 ms), the indicated delay time will vary depending upon the input voltage and the module's internal timing. The waveforms were measured with 48 VDC input voltage, and a 10-A resistive load.

**Turn-Off Time:** When a valid input source is removed or if the *Remote On/Off* (pin 2) is used to disable the output, with no external output capacitance, the module powers down within 200  $\mu$ s. Figure 15 shows that, during power down, there is a small undershoot, typically less than 300 mV (or less than a diode drop). If used to supply processor I/O voltages, the low undershoot ensures the parasitic diodes do not conduct current and potentially cause damage to external circuitry.



t – Time – 5 ms/div

Figure 14. Power Up

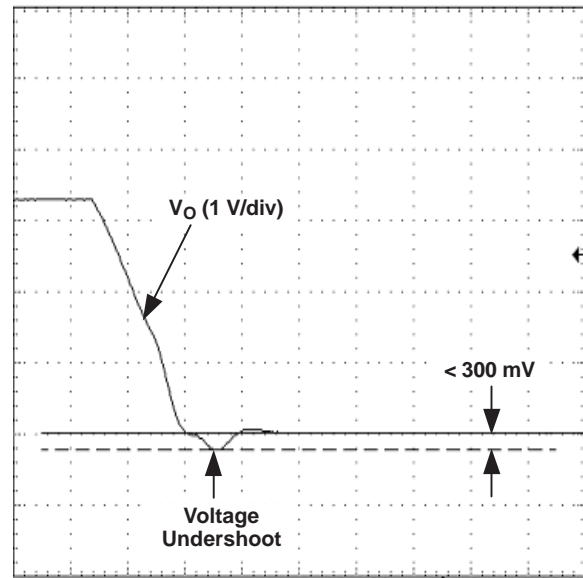

t – Time – 100  $\mu$ s/div

Figure 15. Power Down

### Adjusting the Output Voltage of the 100-W Rated PTQA Series of Isolated DC/DC Converters

The output voltage adjustment of the PTQA series of isolated DC/DC converters follows the standard adopted by popular 1/4-brick DC/DC converters. Adjustment is accomplished with a single external resistor that can adjust the output voltage from –20% to +10% of the nominal set-point voltage. The placement of the resistor determines the direction of adjustment, up or down, and the value of the magnitude of adjustment.

**Adjust Up:** To increase the output voltage add a resistor, R1, between  $V_O$  Adjust (pin 6) and Sense(+) (pin 7).

**Adjust Down:** Add a resistor, (R2), between  $V_O$  Adjust (pin 6) and Sense(–) (pin 5).

Refer to [Figure 16](#) for the placement of the required resistor, R1 or (R2).

The values of R1 [adjust up], and (R2) [adjust down], can be calculated using the following formulas or selected from [Table 4](#).

$$R1 = \frac{5.11 V_O (100 + \Delta\%)}{1.225 \Delta\%} - \frac{511}{\Delta\%} - 10.22 \text{ (k}\Omega\text{)} \tag{1}$$

$$(R2) = 5.11 \frac{100}{\Delta\%} - 10.22 \text{ (k}\Omega\text{)} \tag{2}$$

Where:

$\Delta\%$  = Amount of adjustment in %

$V_O$  = Original set-point voltage

**Notes:**

1. Use only a single 1% resistor in either the R1 or (R2) location. Place the resistor as close to the converter as possible.
2. If the output voltage is increased, the maximum load current must be derated according to the following equation.

$$I_O(\text{max}) = \frac{V_O \times I_O(\text{rated})}{V_A} \tag{3}$$

Where:

$V_O$  = Original set-point voltage

$V_A$  = Adjusted output voltage (measured between pins 8 and 4)

In any instance, the load current must not exceed the converter's maximum rated output current of 30 A.

3. The overvoltage threshold is fixed, and is set approximately 20% above the nominal output voltage. Adjusting the output voltage higher reduces the voltage margin between the adjusted output voltage and the overvoltage (OV) protection threshold. This could make the module sensitive to OV fault detection, as a result of random noise and load transients.

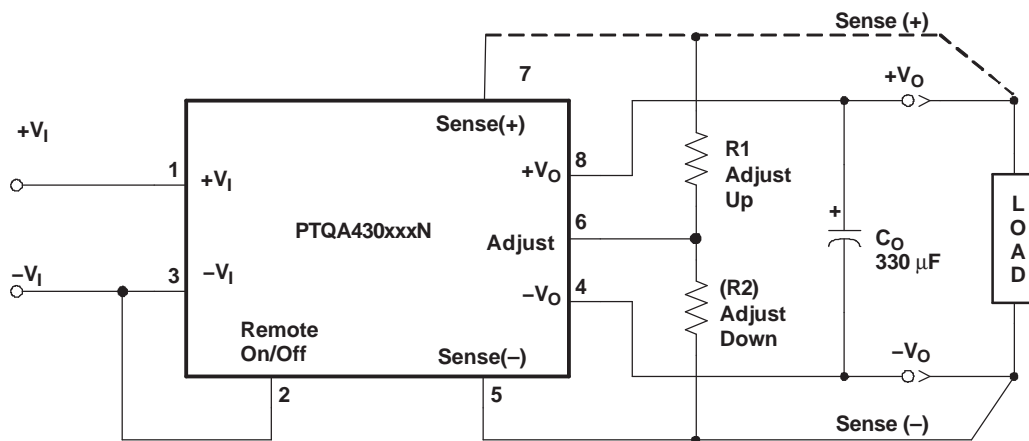

Figure 16.

**Table 4. Standard Adjustment Resistor Values**

V <sub>O</sub> (nom) % Adjust (V)	Adjusted Output Voltage (V)			Trim-Up R <sub>ADJ</sub>			Trim-Down R <sub>ADJ</sub>		
	5.0 V	3.3 V	2.5 V	5.0 V R1 (kΩ)	3.3 V R1 (kΩ)	2.5 V R1 (kΩ)	5.0 V R2 (kΩ)	3.3 V R2 (kΩ)	2.5 V R2 (kΩ)
+10	5.50	3.630	2.750	169	90.9	53.6	-	-	-
+9	5.45	3.597	2.725	187	100	59.0	-	-	-
+8	5.40	3.564	2.700	205	113	66.5	-	-	-
+7	5.35	3.531	2.675	237	127	76.8	-	-	-
+6	5.30	3.498	2.650	274	147	88.7	-	-	-
+5	5.25	3.465	2.625	324	178	107	-	-	-
+4	5.20	3.432	2.600	402	221	133	-	-	-
+3	5.15	3.399	2.575	536	294	178	-	-	-
+2	5.10	3.366	2.550	787	432	267	-	-	-
+1	5.05	3.333	2.525	1580	866	536	-	-	-
0	5.00	3.300	2.500	Open	Open	Open	-	-	-
-1	4.95	3.267	2.475	-	-	-	499	499	499
-2	4.90	3.234	2.450	-	-	-	243	243	243
-3	4.85	3.201	2.425	-	-	-	158	158	158
-4	4.80	3.168	2.400	-	-	-	118	118	118
-5	4.75	3.135	2.375	-	-	-	90.9	90.9	90.9
-6	4.70	3.102	2.350	-	-	-	75	75	75
-7	4.65	3.069	2.325	-	-	-	63.4	63.4	63.4
-8	4.60	3.036	2.300	-	-	-	53.6	53.6	53.6
-9	4.55	3.003	2.275	-	-	-	46.4	46.4	46.4
-10	4.50	2.970	2.250	-	-	-	41.2	41.2	41.2
-11	4.45	2.937	2.225	-	-	-	36.5	36.5	36.5
-12	4.40	2.904	2.200	-	-	-	32.4	32.4	32.4
-13	4.35	2.871	2.175	-	-	-	28.7	28.7	28.7
-14	4.30	2.838	2.150	-	-	-	26.1	26.1	26.1
-15	4.25	2.805	2.125	-	-	-	23.7	23.7	23.7
-16	4.20	2.772	2.100	-	-	-	21.5	21.5	21.5
-17	4.15	2.739	2.075	-	-	-	19.6	19.6	19.6
-18	4.10	2.706	2.050	-	-	-	18.2	18.2	18.2
-19	4.05	2.673	2.025	-	-	-	16.5	16.5	16.5
-20	4.00	2.640	2.000	-	-	-	15.4	15.4	15.4

**PACKAGING INFORMATION**

Orderable Device	Status (1)	Package Type	Package Drawing	Pins	Package Qty	Eco Plan (2)	Lead/Ball Finish (6)	MSL Peak Temp (3)	Op Temp (°C)	Device Marking (4/5)	Samples
PTQA420050N2AD	NRND	Through-Hole Module	EAP	8	9	Pb-Free (RoHS)	SN	N / A for Pkg Type	-40 to 85		
PTQA420050N2AS	NRND	Surface Mount Module	EAQ	8	9	TBD	SNPB	Level-1-235C-UNLIM/ Level-3-260C-168HRS	-40 to 85		
PTQA420050N2AZ	NRND	Surface Mount Module	BAQ	8	9	Pb-Free (RoHS)	SNAGCU	Level-3-260C-168 HR	-40 to 85		
PTQA420050P2AD	NRND	Through-Hole Module	EAP	8	9	Pb-Free (RoHS)	SN	N / A for Pkg Type	-40 to 85		
PTQA420050P2AS	NRND	Surface Mount Module	EAQ	8	9	TBD	SNPB	Level-1-235C-UNLIM/ Level-3-260C-168HRS	-40 to 85		
PTQA420050P2AZ	NRND	Surface Mount Module	BAQ	8	9	Pb-Free (RoHS)	SNAGCU	Level-3-260C-168 HR	-40 to 85		
PTQA430025P2AD	NRND	Through-Hole Module	EAP	8	9	Pb-Free (RoHS)	SN	N / A for Pkg Type	-40 to 85		
PTQA430033N2AD	NRND	Through-Hole Module	EAP	8	9	Pb-Free (RoHS)	SN	N / A for Pkg Type	-40 to 85		

(1) The marketing status values are defined as follows:

**ACTIVE:** Product device recommended for new designs.

**LIFEBUY:** TI has announced that the device will be discontinued, and a lifetime-buy period is in effect.

**NRND:** Not recommended for new designs. Device is in production to support existing customers, but TI does not recommend using this part in a new design.

**PREVIEW:** Device has been announced but is not in production. Samples may or may not be available.

**OBSOLETE:** TI has discontinued the production of the device.

(2) Eco Plan - The planned eco-friendly classification: Pb-Free (RoHS), Pb-Free (RoHS Exempt), or Green (RoHS & no Sb/Br) - please check <http://www.ti.com/productcontent> for the latest availability information and additional product content details.

**TBD:** The Pb-Free/Green conversion plan has not been defined.

**Pb-Free (RoHS):** TI's terms "Lead-Free" or "Pb-Free" mean semiconductor products that are compatible with the current RoHS requirements for all 6 substances, including the requirement that lead not exceed 0.1% by weight in homogeneous materials. Where designed to be soldered at high temperatures, TI Pb-Free products are suitable for use in specified lead-free processes.

**Pb-Free (RoHS Exempt):** This component has a RoHS exemption for either 1) lead-based flip-chip solder bumps used between the die and package, or 2) lead-based die adhesive used between the die and leadframe. The component is otherwise considered Pb-Free (RoHS compatible) as defined above.

**Green (RoHS & no Sb/Br):** TI defines "Green" to mean Pb-Free (RoHS compatible), and free of Bromine (Br) and Antimony (Sb) based flame retardants (Br or Sb do not exceed 0.1% by weight in homogeneous material)

(3) MSL, Peak Temp. - The Moisture Sensitivity Level rating according to the JEDEC industry standard classifications, and peak solder temperature.



(4) There may be additional marking, which relates to the logo, the lot trace code information, or the environmental category on the device.

(5) Multiple Device Markings will be inside parentheses. Only one Device Marking contained in parentheses and separated by a "~" will appear on a device. If a line is indented then it is a continuation of the previous line and the two combined represent the entire Device Marking for that device.

(6) Lead/Ball Finish - Orderable Devices may have multiple material finish options. Finish options are separated by a vertical ruled line. Lead/Ball Finish values may wrap to two lines if the finish value exceeds the maximum column width.

**Important Information and Disclaimer:**The information provided on this page represents TI's knowledge and belief as of the date that it is provided. TI bases its knowledge and belief on information provided by third parties, and makes no representation or warranty as to the accuracy of such information. Efforts are underway to better integrate information from third parties. TI has taken and continues to take reasonable steps to provide representative and accurate information but may not have conducted destructive testing or chemical analysis on incoming materials and chemicals. TI and TI suppliers consider certain information to be proprietary, and thus CAS numbers and other limited information may not be available for release.

In no event shall TI's liability arising out of such information exceed the total purchase price of the TI part(s) at issue in this document sold by TI to Customer on an annual basis.

EAP (R-PDSS-T8)

DOUBLE SIDED MODULE

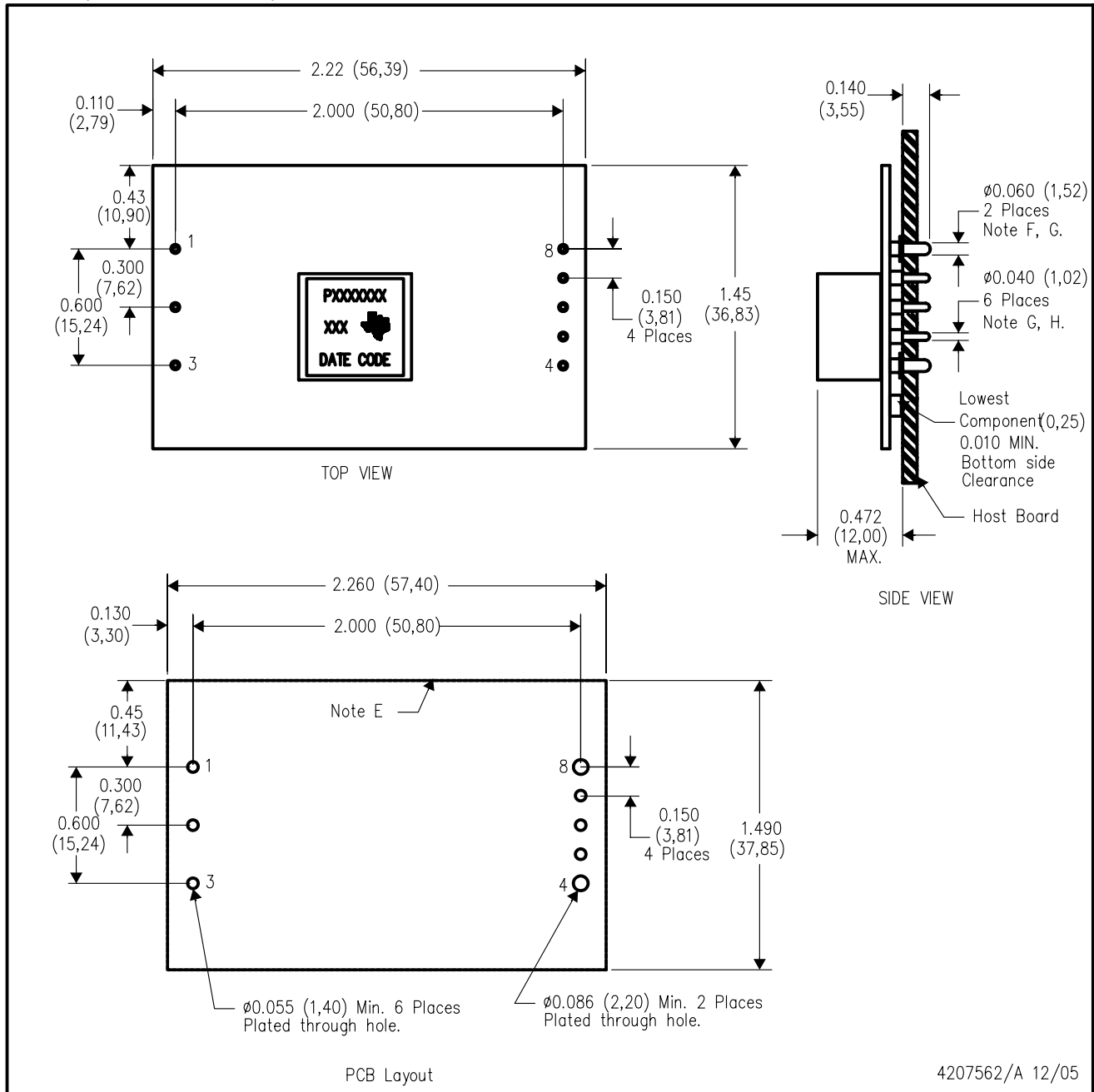

- NOTES:
- A. All linear dimensions are in inches (mm).
  - B. This drawing is subject to change without notice.
  - C. 2 place decimals are  $\pm 0.020$  ( $\pm 0,51$ mm).
  - D. 3 place decimals are  $\pm 0.010$  ( $\pm 0,25$ mm).
  - E. Recommended keep out area for user components.

- F. Pins are 0.060" (1,52) diameter with 0.125" (3,20) diameter standoff shoulder.
- G. All pins: Material - Copper Alloy  
Finish - Tin (100%) over Nickel plate
- H. Pins are 0.040" (1,02) diameter with 0.070" (1,78) diameter standoff shoulder.

EAQ (R-PDSS-B8)

DOUBLE SIDED MODULE

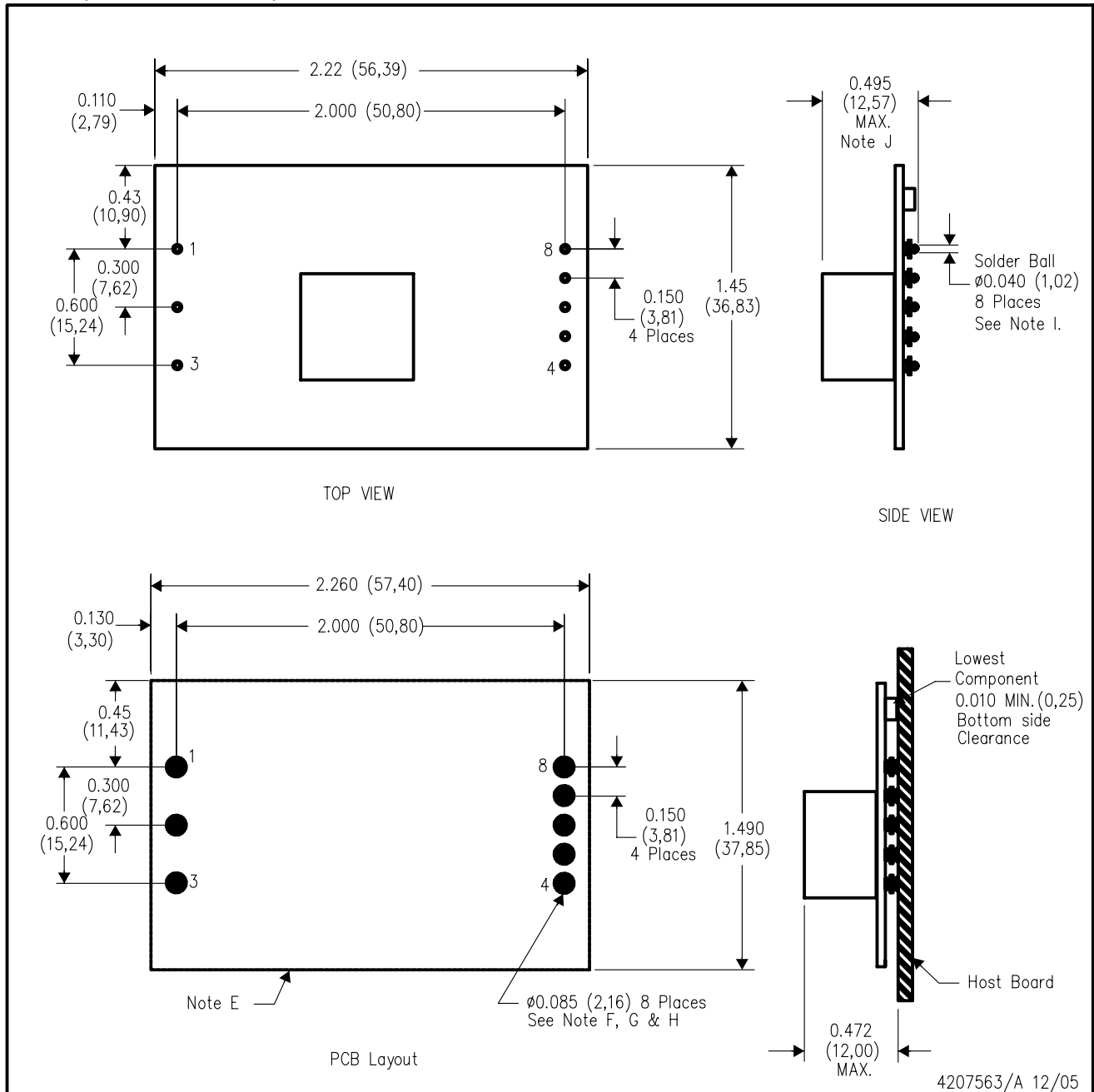

- NOTES:
- A. All linear dimensions are in inches (mm).
  - B. This drawing is subject to change without notice.
  - C. 2 place decimals are  $\pm 0.020$  ( $\pm 0,51$ mm).
  - D. 3 place decimals are  $\pm 0.010$  ( $\pm 0,25$ mm).
  - E. Recommended keep out area for user components.
  - F. Power pin connection should utilize four or more vias to the interior power plane of 0.025 (0,63) I.D. per input, ground and output pin (or the electrical equivalent).

- G. Paste screen opening: 0.080 (2,03) to 0.085 (2,16).  
Paste screen thickness: 0.006 (0,15).
- H. Pad type: Solder mask defined.
- I. All pins: Material – Copper Alloy  
Finish – Tin (100%) over Nickel plate  
Solder Ball – See product data sheet.
- J. Dimension prior to reflow solder.

BAQ (R-PDSS-B8)

DOUBLE SIDED MODULE

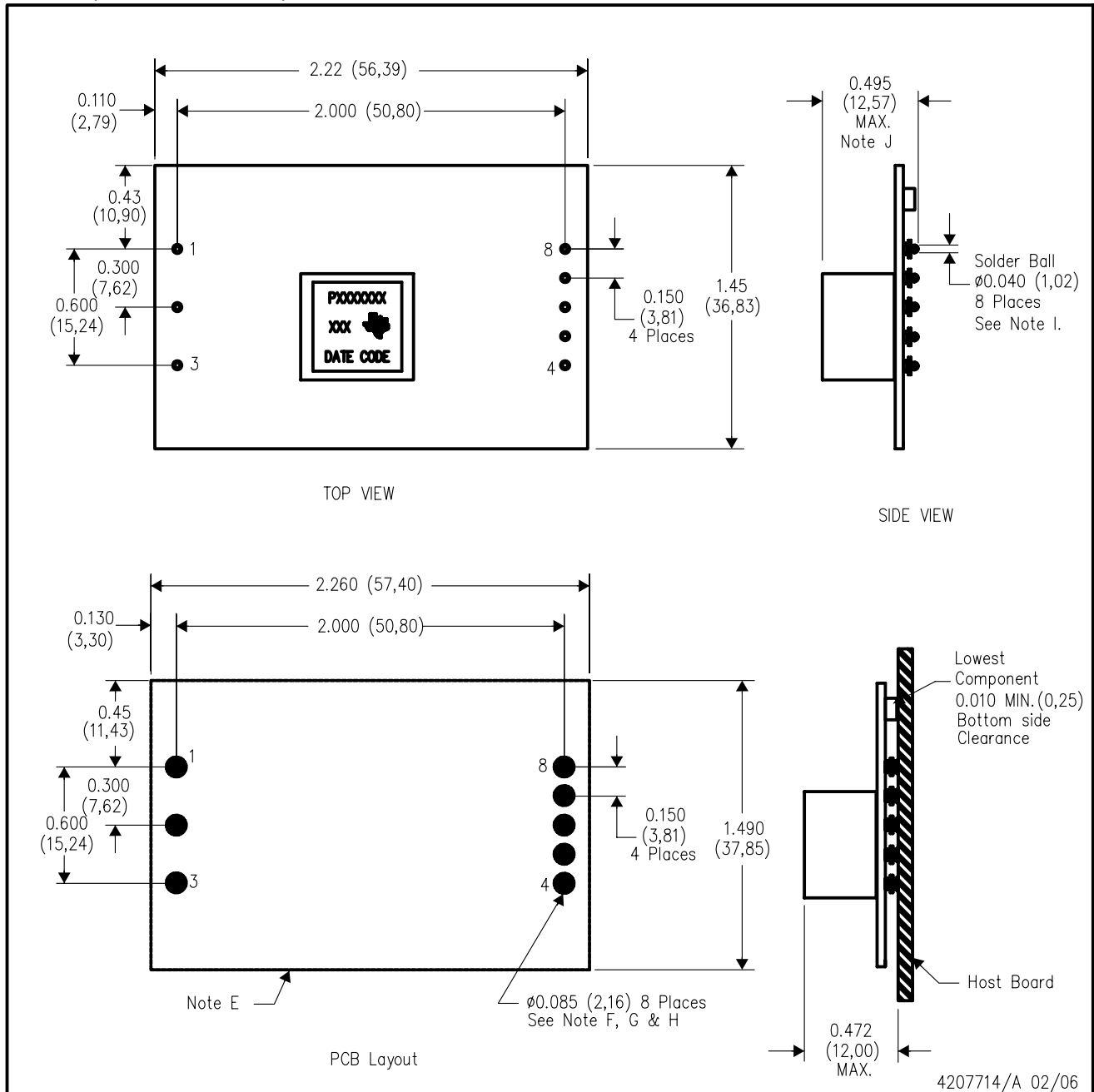

- NOTES:
- A. All linear dimensions are in inches (mm).
  - B. This drawing is subject to change without notice.
  - C. 2 place decimals are  $\pm 0.020$  ( $\pm 0,51$ mm).
  - D. 3 place decimals are  $\pm 0.010$  ( $\pm 0,25$ mm).
  - E. Recommended keep out area for user components.
  - F. Power pin connection should utilize four or more vias to the interior power plane of 0.025 (0,63) I.D. per input, ground and output pin (or the electrical equivalent).
  - G. Paste screen opening: 0.080 (2,03) to 0.085 (2,16).  
Paste screen thickness: 0.006 (0,15).
  - H. Pad type: Solder mask defined.
  - I. All pins: Material – Copper Alloy  
Finish – Tin (100%) over Nickel plate  
Solder Ball – 96.5 Sn/3.0 Ag/0.5 Cu
  - J. Dimension prior to reflow solder.

## IMPORTANT NOTICE

Texas Instruments Incorporated and its subsidiaries (TI) reserve the right to make corrections, enhancements, improvements and other changes to its semiconductor products and services per JESD46, latest issue, and to discontinue any product or service per JESD48, latest issue. Buyers should obtain the latest relevant information before placing orders and should verify that such information is current and complete. All semiconductor products (also referred to herein as "components") are sold subject to TI's terms and conditions of sale supplied at the time of order acknowledgment.

TI warrants performance of its components to the specifications applicable at the time of sale, in accordance with the warranty in TI's terms and conditions of sale of semiconductor products. Testing and other quality control techniques are used to the extent TI deems necessary to support this warranty. Except where mandated by applicable law, testing of all parameters of each component is not necessarily performed.

TI assumes no liability for applications assistance or the design of Buyers' products. Buyers are responsible for their products and applications using TI components. To minimize the risks associated with Buyers' products and applications, Buyers should provide adequate design and operating safeguards.

TI does not warrant or represent that any license, either express or implied, is granted under any patent right, copyright, mask work right, or other intellectual property right relating to any combination, machine, or process in which TI components or services are used. Information published by TI regarding third-party products or services does not constitute a license to use such products or services or a warranty or endorsement thereof. Use of such information may require a license from a third party under the patents or other intellectual property of the third party, or a license from TI under the patents or other intellectual property of TI.

Reproduction of significant portions of TI information in TI data books or data sheets is permissible only if reproduction is without alteration and is accompanied by all associated warranties, conditions, limitations, and notices. TI is not responsible or liable for such altered documentation. Information of third parties may be subject to additional restrictions.

Resale of TI components or services with statements different from or beyond the parameters stated by TI for that component or service voids all express and any implied warranties for the associated TI component or service and is an unfair and deceptive business practice. TI is not responsible or liable for any such statements.

Buyer acknowledges and agrees that it is solely responsible for compliance with all legal, regulatory and safety-related requirements concerning its products, and any use of TI components in its applications, notwithstanding any applications-related information or support that may be provided by TI. Buyer represents and agrees that it has all the necessary expertise to create and implement safeguards which anticipate dangerous consequences of failures, monitor failures and their consequences, lessen the likelihood of failures that might cause harm and take appropriate remedial actions. Buyer will fully indemnify TI and its representatives against any damages arising out of the use of any TI components in safety-critical applications.

In some cases, TI components may be promoted specifically to facilitate safety-related applications. With such components, TI's goal is to help enable customers to design and create their own end-product solutions that meet applicable functional safety standards and requirements. Nonetheless, such components are subject to these terms.

No TI components are authorized for use in FDA Class III (or similar life-critical medical equipment) unless authorized officers of the parties have executed a special agreement specifically governing such use.

Only those TI components which TI has specifically designated as military grade or "enhanced plastic" are designed and intended for use in military/aerospace applications or environments. Buyer acknowledges and agrees that any military or aerospace use of TI components which have **not** been so designated is solely at the Buyer's risk, and that Buyer is solely responsible for compliance with all legal and regulatory requirements in connection with such use.

TI has specifically designated certain components as meeting ISO/TS16949 requirements, mainly for automotive use. In any case of use of non-designated products, TI will not be responsible for any failure to meet ISO/TS16949.

### Products

Audio	<a href="http://www.ti.com/audio">www.ti.com/audio</a>
Amplifiers	<a href="http://amplifier.ti.com">amplifier.ti.com</a>
Data Converters	<a href="http://dataconverter.ti.com">dataconverter.ti.com</a>
DLP® Products	<a href="http://www.dlp.com">www.dlp.com</a>
DSP	<a href="http://dsp.ti.com">dsp.ti.com</a>
Clocks and Timers	<a href="http://www.ti.com/clocks">www.ti.com/clocks</a>
Interface	<a href="http://interface.ti.com">interface.ti.com</a>
Logic	<a href="http://logic.ti.com">logic.ti.com</a>
Power Mgmt	<a href="http://power.ti.com">power.ti.com</a>
Microcontrollers	<a href="http://microcontroller.ti.com">microcontroller.ti.com</a>
RFID	<a href="http://www.ti-rfid.com">www.ti-rfid.com</a>
OMAP Applications Processors	<a href="http://www.ti.com/omap">www.ti.com/omap</a>
Wireless Connectivity	<a href="http://www.ti.com/wirelessconnectivity">www.ti.com/wirelessconnectivity</a>

### Applications

Automotive and Transportation	<a href="http://www.ti.com/automotive">www.ti.com/automotive</a>
Communications and Telecom	<a href="http://www.ti.com/communications">www.ti.com/communications</a>
Computers and Peripherals	<a href="http://www.ti.com/computers">www.ti.com/computers</a>
Consumer Electronics	<a href="http://www.ti.com/consumer-apps">www.ti.com/consumer-apps</a>
Energy and Lighting	<a href="http://www.ti.com/energy">www.ti.com/energy</a>
Industrial	<a href="http://www.ti.com/industrial">www.ti.com/industrial</a>
Medical	<a href="http://www.ti.com/medical">www.ti.com/medical</a>
Security	<a href="http://www.ti.com/security">www.ti.com/security</a>
Space, Avionics and Defense	<a href="http://www.ti.com/space-avionics-defense">www.ti.com/space-avionics-defense</a>
Video and Imaging	<a href="http://www.ti.com/video">www.ti.com/video</a>

### TI E2E Community

[e2e.ti.com](http://e2e.ti.com)