

SN54ABT533, SN74ABT533A OCTAL TRANSPARENT D-TYPE LATCHES WITH 3-STATE OUTPUTS

SCBS186D – JANUARY 1991 – REVISED JANUARY 1997

- State-of-the-Art *EPIC-IIB™* BiCMOS Design Significantly Reduces Power Dissipation
- Latch-Up Performance Exceeds 500 mA Per JEDEC Standard JESD-17
- Typical V_{OLP} (Output Ground Bounce) < 1 V at $V_{CC} = 5$ V, $T_A = 25^\circ\text{C}$
- High-Drive Outputs ($-32\text{-mA } I_{OH}$, $64\text{-mA } I_{OL}$)
- ESD Protection Exceeds 2000 V Per MIL-STD-883, Method 3015; Exceeds 200 V Using Machine Model ($C = 200$ pF, $R = 0$)
- Package Options Include Plastic Small-Outline (DW), Shrink Small-Outline (DB), and Thin Shrink Small-Outline (PW) Packages, Ceramic Chip Carriers (FK), Plastic (N) and Ceramic (J) DIPs, and Ceramic Flat (W) Package

description

These octal transparent D-type latches with 3-state outputs are designed specifically for driving highly capacitive or relatively low-impedance loads. They are particularly suitable for implementing buffer registers, I/O ports, bidirectional bus drivers, and working registers.

When the latch-enable (LE) input is high, the \bar{Q} outputs follow the complements of the data (D) inputs. When LE is taken low, the \bar{Q} outputs are latched at the inverse of the levels at the D inputs.

A buffered output-enable (\overline{OE}) input can be used to place the eight outputs in either a normal logic state (high or low logic levels) or a high-impedance state. In the high-impedance state, the outputs neither load nor drive the bus lines significantly. The high-impedance state and increased drive provide the capability to drive bus lines without need for interface or pullup components.

\overline{OE} does not affect the internal operations of the latches. Previously stored data can be retained or new data can be entered while the outputs are in the high-impedance state.

To ensure the high-impedance state during power up or power down, \overline{OE} should be tied to V_{CC} through a pullup resistor; the minimum value of the resistor is determined by the current-sinking capability of the driver.

The SN54ABT533 is characterized for operation over the full military temperature range of -55°C to 125°C . The SN74ABT533A is characterized for operation from -40°C to 85°C .

SN54ABT533 . . . J OR W PACKAGE
SN74ABT533A . . . DB, DW, N, OR PW PACKAGE
(TOP VIEW)

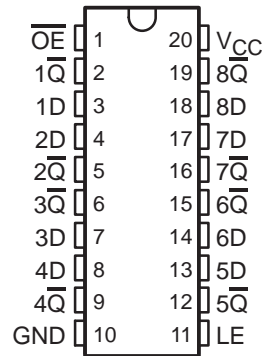

SN54ABT533 . . . FK PACKAGE
(TOP VIEW)

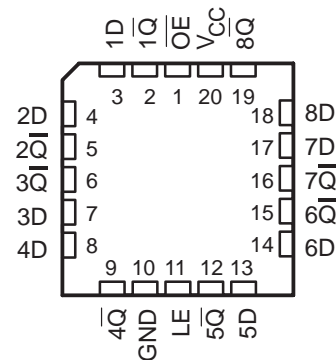

Please be aware that an important notice concerning availability, standard warranty, and use in critical applications of Texas Instruments semiconductor products and disclaimers thereto appears at the end of this data sheet.

EPIC-IIB is a trademark of Texas Instruments Incorporated.

PRODUCTION DATA information is current as of publication date. Products conform to specifications per the terms of Texas Instruments standard warranty. Production processing does not necessarily include testing of all parameters.



POST OFFICE BOX 655303 • DALLAS, TEXAS 75265

Copyright © 1997, Texas Instruments Incorporated

SN54ABT533, SN74ABT533A OCTAL TRANSPARENT D-TYPE LATCHES WITH 3-STATE OUTPUTS

SCBS186D – JANUARY 1991 – REVISED JANUARY 1997

FUNCTION TABLE
(each latch)

INPUTS			OUTPUT
\overline{OE}	LE	D	\overline{Q}
L	H	H	L
L	H	L	H
L	L	X	$\overline{Q_0}$
H	X	X	Z

logic symbol†

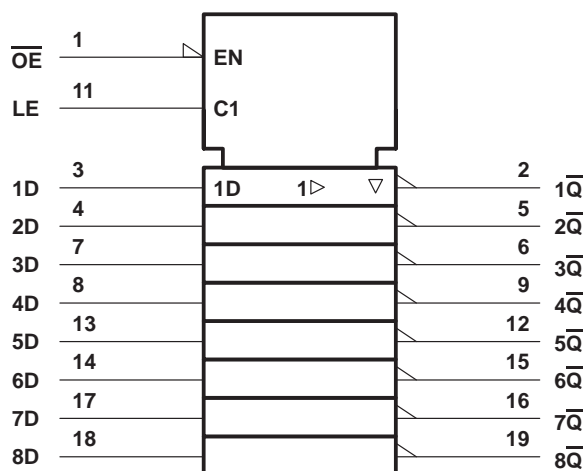

logic diagram (positive logic)

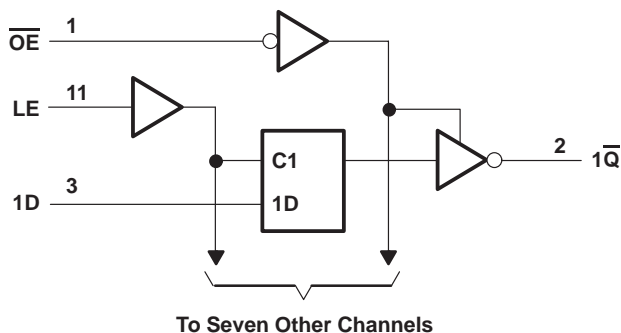

† This symbol is in accordance with ANSI/IEEE Std 91-1984 and IEC Publication 617-12.

absolute maximum ratings over operating free-air temperature range (unless otherwise noted)‡

Supply voltage range, V_{CC}	-0.5 V to 7 V
Input voltage range, V_I (see Note 1)	-0.5 V to 7 V
Voltage range applied to any output in the high or power-off state, V_O	-0.5 V to 5.5 V
Current into any output in the low state, I_O : SN54ABT533	96 mA
SN74ABT533A	128 mA
Input clamp current, I_{IK} ($V_I < 0$)	-18 mA
Output clamp current, I_{OK} ($V_O < 0$)	-50 mA
Package thermal impedance, θ_{JA} (see Note 2): DB package	115°C/W
DW package	97°C/W
N package	67°C/W
PW package	128°C/W
Storage temperature range, T_{stg}	-65°C to 150°C

‡ Stresses beyond those listed under "absolute maximum ratings" may cause permanent damage to the device. These are stress ratings only, and functional operation of the device at these or any other conditions beyond those indicated under "recommended operating conditions" is not implied. Exposure to absolute-maximum-rated conditions for extended periods may affect device reliability.

NOTES: 1. The input and output negative-voltage ratings may be exceeded if the input and output clamp-current ratings are observed.
2. The package thermal impedance is calculated in accordance with EIA/JEDEC Std JESD51, except for through-hole packages, which use a trace length of zero.

SN54ABT533, SN74ABT533A OCTAL TRANSPARENT D-TYPE LATCHES WITH 3-STATE OUTPUTS

SCBS186D – JANUARY 1991 – REVISED JANUARY 1997

recommended operating conditions (see Note 3)

		SN54ABT533		SN74ABT533A		UNIT
		MIN	MAX	MIN	MAX	
V _{CC}	Supply voltage	4.5	5.5	4.5	5.5	V
V _{IH}	High-level input voltage	2		2		V
V _{IL}	Low-level input voltage		0.8		0.8	V
V _I	Input voltage	0	V _{CC}	0	V _{CC}	V
I _{OH}	High-level output current		-24		-32	mA
I _{OL}	Low-level output current		48		64	mA
Δt/Δv	Input transition rise or fall rate		10		10	ns/V
T _A	Operating free-air temperature	-55	125	-40	85	°C

NOTE 3: Unused inputs must be held high or low to prevent them from floating.

electrical characteristics over recommended operating free-air temperature range (unless otherwise noted)

PARAMETER	TEST CONDITIONS	T _A = 25°C			SN54ABT533		SN74ABT533A		UNIT
		MIN	TYP†	MAX	MIN	MAX	MIN	MAX	
V _{IK}	V _{CC} = 4.5 V, I _I = -18 mA			-1.2		-1.2		-1.2	V
V _{OH}	V _{CC} = 4.5 V, I _{OH} = -3 mA	2.5			2.5		2.5		V
	V _{CC} = 5 V, I _{OH} = -3 mA	3			3		3		
	V _{CC} = 4.5 V	I _{OH} = -24 mA	2			2			
I _{OH} = -32 mA		2*					2		
V _{OL}	V _{CC} = 4.5 V	I _{OL} = 48 mA		0.55		0.55			V
		I _{OL} = 64 mA		0.55*			0.55		
V _{hys}			100						mV
I _I	V _{CC} = 5.5 V, V _I = V _{CC} or GND			±1		±1		±1	μA
I _{OZH}	V _{CC} = 5.5 V, V _O = 2.7 V			10		10		10	μA
I _{OZL}	V _{CC} = 5.5 V, V _O = 0.5 V			-10		-10		-10	μA
I _{off}	V _{CC} = 0, V _I or V _O ≤ 4.5 V			±150				±150	μA
I _{CEX}	V _{CC} = 5.5 V, V _O = 5.5 V	Outputs high		50		50		50	μA
I _{O‡}	V _{CC} = 5.5 V, V _O = 2.5 V	-50	-140	-180	-50	-180	-50	-180	mA
I _{CC}	V _{CC} = 5.5 V, I _O = 0, V _I = V _{CC} or GND	Outputs high		1	250	250	250	250	μA
		Outputs low		24	30	30	30	30	mA
		Outputs disabled		0.5	250	250	250	250	μA
ΔI _{CC} §	V _{CC} = 5.5 V, One input at 3.4 V, Other inputs at V _{CC} or GND	Outputs high		1.5		1.5		1.5	mA
		Outputs low		1.5		1.5		1.5	
		Outputs disabled		1.5		1.5		1.5	
C _i	V _I = 2.5 V or 0.5 V		3.5						pF
C _o	V _O = 2.5 V or 0.5 V		6.5						pF

* On products compliant to MIL-PRF-38535, this parameter does not apply.

† All typical values are at V_{CC} = 5 V.

‡ Not more than one output should be tested at a time, and the duration of the test should not exceed one second.

§ This is the increase in supply current for each input that is at the specified TTL voltage level rather than V_{CC} or GND.



SN54ABT533, SN74ABT533A
OCTAL TRANSPARENT D-TYPE LATCHES
WITH 3-STATE OUTPUTS

SCBS186D – JANUARY 1991 – REVISED JANUARY 1997

timing requirements over recommended ranges of supply voltage and operating free-air temperature (unless otherwise noted) (see Figure 1)

		SN54ABT533				UNIT	
		V _{CC} = 5 V, T _A = 25°C			MIN		MAX
		MIN	MAX				
t _w	Pulse duration, LE high		3.3		3.3	ns	
t _{su}	Setup time, data before LE↓	High or low	2.1		2.1	ns	
t _h	Hold time, data after LE↓	High or low	1.5		1.5	ns	

timing requirements over recommended ranges of supply voltage and operating free-air temperature (unless otherwise noted) (see Figure 1)

		SN74ABT533A				UNIT	
		V _{CC} = 5 V, T _A = 25°C			MIN		MAX
		MIN	MAX				
t _w	Pulse duration, LE high		3.3		3.3	ns	
t _{su}	Setup time, data before LE↓	High or low	2.1		2.1	ns	
t _h	Hold time, data after LE↓	High or low	2.1		2.1	ns	

switching characteristics over recommended ranges of supply voltage and operating free-air temperature, C_L = 50 pF (unless otherwise noted) (see Figure 1)

PARAMETER	FROM (INPUT)	TO (OUTPUT)	SN54ABT533					UNIT
			V _{CC} = 5 V, T _A = 25°C			MIN	MAX	
			MIN	TYP	MAX			
t _{PLH}	D	Q̄	1.9	4.2	5.4	1.9	6.7	ns
t _{PHL}			3.1	4.9	6.3			
t _{PLH}	LE	Q̄	2.7	4.9	6.2	2.7	7.6	ns
t _{PHL}			3.5	5.4	6.8			
t _{PZH}	OĒ	Q̄	1.6	3.7	4.8	1.6	5.8	ns
t _{PZL}			2.4	4.2	6.2			
t _{PHZ}	OĒ	Q̄	2.8	5.1	6.2	2.8	7.2	ns
t _{PLZ}			2	4.1	6			



SN54ABT533, SN74ABT533A
OCTAL TRANSPARENT D-TYPE LATCHES
WITH 3-STATE OUTPUTS

SCBS186D – JANUARY 1991 – REVISED JANUARY 1997

switching characteristics over recommended ranges of supply voltage and operating free-air temperature, $C_L = 50$ pF (unless otherwise noted) (see Figure 1)

PARAMETER	FROM (INPUT)	TO (OUTPUT)	SN74ABT533A				UNIT	
			$V_{CC} = 5$ V, $T_A = 25^\circ\text{C}$			MIN		MAX
			MIN	TYP	MAX			
t_{PLH}	D	\bar{Q}	1.7	4.2	5.4	1.7	6.4	ns
t_{PHL}			2.6	4.9	6.3	2.6	6.6	
t_{PLH}	LE	\bar{Q}	2.7	4.9	6.2	2.7	7.3	ns
t_{PHL}			3.5	5.4	6.8	3.5	7.3	
t_{PZH}	\overline{OE}	\bar{Q}	1.6	3.7	4.8	1.6	5.7	ns
t_{PZL}			2.4	4.2	6.2	2.4	6.7	
t_{PHZ}	\overline{OE}	\bar{Q}	1.6	5.1	6.2	1.6	6.9	ns
t_{PLZ}			2	4.1	6	2	6.5	

SN54ABT533, SN74ABT533A OCTAL TRANSPARENT D-TYPE LATCHES WITH 3-STATE OUTPUTS

SCBS186D – JANUARY 1991 – REVISED JANUARY 1997

PARAMETER MEASUREMENT INFORMATION



LOAD CIRCUIT

TEST	S1
t_{PLH}/t_{PHL}	Open
t_{PLZ}/t_{PZL}	7 V
t_{PHZ}/t_{PZH}	Open



VOLTAGE WAVEFORMS
PULSE DURATION



VOLTAGE WAVEFORMS
SETUP AND HOLD TIMES



VOLTAGE WAVEFORMS
PROPAGATION DELAY TIMES
INVERTING AND NONINVERTING OUTPUTS









VOLTAGE WAVEFORMS
ENABLE AND DISABLE TIMES
LOW- AND HIGH-LEVEL ENABLING

- NOTES: A. C_L includes probe and jig capacitance.
 B. Waveform 1 is for an output with internal conditions such that the output is low except when disabled by the output control. Waveform 2 is for an output with internal conditions such that the output is high except when disabled by the output control.
 C. All input pulses are supplied by generators having the following characteristics: $PRR \leq 10 \text{ MHz}$, $Z_O = 50 \Omega$, $t_r \leq 2.5 \text{ ns}$, $t_f \leq 2.5 \text{ ns}$.
 D. The outputs are measured one at a time with one transition per measurement.

Figure 1. Load Circuit and Voltage Waveforms

PACKAGING INFORMATION

Orderable Device	Status (1)	Package Type	Package Drawing	Pins	Package Qty	Eco Plan (2)	Lead/Ball Finish (6)	MSL Peak Temp (3)	Op Temp (°C)	Device Marking (4/5)	Samples
5962-9584301Q2A	ACTIVE	LCCC	FK	20	1	TBD	POST-PLATE	N / A for Pkg Type	-55 to 125	5962- 9584301Q2A SNJ54 ABT533FK	
5962-9584301QRA	ACTIVE	CDIP	J	20	1	TBD	A42	N / A for Pkg Type	-55 to 125	5962-9584301QR A SNJ54ABT533J	
SN74ABT533ADBLE	OBSOLETE	SSOP	DB	20		TBD	Call TI	Call TI	-40 to 85		
SN74ABT533ADW	ACTIVE	SOIC	DW	20	25	Green (RoHS & no Sb/Br)	CU NIPDAU	Level-1-260C-UNLIM	-40 to 85	ABT533A	
SN74ABT533AN	ACTIVE	PDIP	N	20	20	Pb-Free (RoHS)	CU NIPDAU	N / A for Pkg Type	-40 to 85	SN74ABT533AN	
SN74ABT533APWLE	OBSOLETE	TSSOP	PW	20		TBD	Call TI	Call TI	-40 to 85		
SN74ABT533APWR	ACTIVE	TSSOP	PW	20	2000	Green (RoHS & no Sb/Br)	CU NIPDAU	Level-1-260C-UNLIM	-40 to 85	AB533A	
SNJ54ABT533FK	ACTIVE	LCCC	FK	20	1	TBD	POST-PLATE	N / A for Pkg Type	-55 to 125	5962- 9584301Q2A SNJ54 ABT533FK	
SNJ54ABT533J	ACTIVE	CDIP	J	20	1	TBD	A42	N / A for Pkg Type	-55 to 125	5962-9584301QR A SNJ54ABT533J	

(1) The marketing status values are defined as follows:

ACTIVE: Product device recommended for new designs.

LIFEBUY: TI has announced that the device will be discontinued, and a lifetime-buy period is in effect.

NRND: Not recommended for new designs. Device is in production to support existing customers, but TI does not recommend using this part in a new design.

PREVIEW: Device has been announced but is not in production. Samples may or may not be available.

OBSOLETE: TI has discontinued the production of the device.

(2) Eco Plan - The planned eco-friendly classification: Pb-Free (RoHS), Pb-Free (RoHS Exempt), or Green (RoHS & no Sb/Br) - please check <http://www.ti.com/productcontent> for the latest availability information and additional product content details.

TBD: The Pb-Free/Green conversion plan has not been defined.

Pb-Free (RoHS): TI's terms "Lead-Free" or "Pb-Free" mean semiconductor products that are compatible with the current RoHS requirements for all 6 substances, including the requirement that lead not exceed 0.1% by weight in homogeneous materials. Where designed to be soldered at high temperatures, TI Pb-Free products are suitable for use in specified lead-free processes.

Pb-Free (RoHS Exempt): This component has a RoHS exemption for either 1) lead-based flip-chip solder bumps used between the die and package, or 2) lead-based die adhesive used between the die and leadframe. The component is otherwise considered Pb-Free (RoHS compatible) as defined above.

Green (RoHS & no Sb/Br): TI defines "Green" to mean Pb-Free (RoHS compatible), and free of Bromine (Br) and Antimony (Sb) based flame retardants (Br or Sb do not exceed 0.1% by weight in homogeneous material)

(3) MSL, Peak Temp. - The Moisture Sensitivity Level rating according to the JEDEC industry standard classifications, and peak solder temperature.

(4) There may be additional marking, which relates to the logo, the lot trace code information, or the environmental category on the device.

(5) Multiple Device Markings will be inside parentheses. Only one Device Marking contained in parentheses and separated by a "~" will appear on a device. If a line is indented then it is a continuation of the previous line and the two combined represent the entire Device Marking for that device.

(6) Lead/Ball Finish - Orderable Devices may have multiple material finish options. Finish options are separated by a vertical ruled line. Lead/Ball Finish values may wrap to two lines if the finish value exceeds the maximum column width.

Important Information and Disclaimer: The information provided on this page represents TI's knowledge and belief as of the date that it is provided. TI bases its knowledge and belief on information provided by third parties, and makes no representation or warranty as to the accuracy of such information. Efforts are underway to better integrate information from third parties. TI has taken and continues to take reasonable steps to provide representative and accurate information but may not have conducted destructive testing or chemical analysis on incoming materials and chemicals. TI and TI suppliers consider certain information to be proprietary, and thus CAS numbers and other limited information may not be available for release.

In no event shall TI's liability arising out of such information exceed the total purchase price of the TI part(s) at issue in this document sold by TI to Customer on an annual basis.

OTHER QUALIFIED VERSIONS OF SN54ABT533 :

- Catalog: [SN74ABT533](#)

NOTE: Qualified Version Definitions:

- Catalog - TI's standard catalog product

TAPE AND REEL INFORMATION



QUADRANT ASSIGNMENTS FOR PIN 1 ORIENTATION IN TAPE



*All dimensions are nominal

Device	Package Type	Package Drawing	Pins	SPQ	Reel Diameter (mm)	Reel Width W1 (mm)	A0 (mm)	B0 (mm)	K0 (mm)	P1 (mm)	W (mm)	Pin1 Quadrant
SN74ABT533APWR	TSSOP	PW	20	2000	330.0	16.4	6.95	7.1	1.6	8.0	16.0	Q1

TAPE AND REEL BOX DIMENSIONS



*All dimensions are nominal

Device	Package Type	Package Drawing	Pins	SPQ	Length (mm)	Width (mm)	Height (mm)
SN74ABT533APWR	TSSOP	PW	20	2000	367.0	367.0	38.0

FK (S-CQCC-N**)

LEADLESS CERAMIC CHIP CARRIER

28 TERMINAL SHOWN



NO. OF TERMINALS **	A		B	
	MIN	MAX	MIN	MAX
20	0.342 (8,69)	0.358 (9,09)	0.307 (7,80)	0.358 (9,09)
28	0.442 (11,23)	0.458 (11,63)	0.406 (10,31)	0.458 (11,63)
44	0.640 (16,26)	0.660 (16,76)	0.495 (12,58)	0.560 (14,22)
52	0.740 (18,78)	0.761 (19,32)	0.495 (12,58)	0.560 (14,22)
68	0.938 (23,83)	0.962 (24,43)	0.850 (21,6)	0.858 (21,8)
84	1.141 (28,99)	1.165 (29,59)	1.047 (26,6)	1.063 (27,0)



4040140/D 01/11

- NOTES:
- A. All linear dimensions are in inches (millimeters).
 - B. This drawing is subject to change without notice.
 - C. This package can be hermetically sealed with a metal lid.
 - D. Falls within JEDEC MS-004

N (R-PDIP-T**)

PLASTIC DUAL-IN-LINE PACKAGE

16 PINS SHOWN



- NOTES:
- A. All linear dimensions are in inches (millimeters).
 - B. This drawing is subject to change without notice.
 - Falls within JEDEC MS-001, except 18 and 20 pin minimum body length (Dim A).
 - The 20 pin end lead shoulder width is a vendor option, either half or full width.

DW0020A



PACKAGE OUTLINE

SOIC - 2.65 mm max height

SOIC



NOTES:

1. All linear dimensions are in millimeters. Dimensions in parenthesis are for reference only. Dimensioning and tolerancing per ASME Y14.5M.
2. This drawing is subject to change without notice.
3. This dimension does not include mold flash, protrusions, or gate burrs. Mold flash, protrusions, or gate burrs shall not exceed 0.15 mm per side.
4. This dimension does not include interlead flash. Interlead flash shall not exceed 0.43 mm per side.
5. Reference JEDEC registration MS-013.

EXAMPLE BOARD LAYOUT

DW0020A

SOIC - 2.65 mm max height

SOIC



LAND PATTERN EXAMPLE
SCALE:6X



SOLDER MASK DETAILS

4220724/A 05/2016

NOTES: (continued)

- 6. Publication IPC-7351 may have alternate designs.
- 7. Solder mask tolerances between and around signal pads can vary based on board fabrication site.

EXAMPLE STENCIL DESIGN

DW0020A

SOIC - 2.65 mm max height

SOIC



SOLDER PASTE EXAMPLE
BASED ON 0.125 mm THICK STENCIL
SCALE:6X

4220724/A 05/2016

NOTES: (continued)

8. Laser cutting apertures with trapezoidal walls and rounded corners may offer better paste release. IPC-7525 may have alternate design recommendations.
9. Board assembly site may have different recommendations for stencil design.

J (R-GDIP-T**)

14 LEADS SHOWN

CERAMIC DUAL IN-LINE PACKAGE



DIM \ PINS **	14	16	18	20
A	0.300 (7,62) BSC	0.300 (7,62) BSC	0.300 (7,62) BSC	0.300 (7,62) BSC
B MAX	0.785 (19,94)	.840 (21,34)	0.960 (24,38)	1.060 (26,92)
B MIN	—	—	—	—
C MAX	0.300 (7,62)	0.300 (7,62)	0.310 (7,87)	0.300 (7,62)
C MIN	0.245 (6,22)	0.245 (6,22)	0.220 (5,59)	0.245 (6,22)



4040083/F 03/03

- NOTES:
- All linear dimensions are in inches (millimeters).
 - This drawing is subject to change without notice.
 - This package is hermetically sealed with a ceramic lid using glass frit.
 - Index point is provided on cap for terminal identification only on press ceramic glass frit seal only.
 - Falls within MIL STD 1835 GDIP1-T14, GDIP1-T16, GDIP1-T18 and GDIP1-T20.

PW (R-PDSO-G20)

PLASTIC SMALL OUTLINE



- NOTES:
- A. All linear dimensions are in millimeters. Dimensioning and tolerancing per ASME Y14.5M-1994.
 - B. This drawing is subject to change without notice.
 - C. Body length does not include mold flash, protrusions, or gate burrs. Mold flash, protrusions, or gate burrs shall not exceed 0,15 each side.
 - D. Body width does not include interlead flash. Interlead flash shall not exceed 0,25 each side.
 - E. Falls within JEDEC MO-153

PW (R-PDSO-G20)

PLASTIC SMALL OUTLINE



- NOTES:
- A. All linear dimensions are in millimeters.
 - B. This drawing is subject to change without notice.
 - C. Publication IPC-7351 is recommended for alternate design.
 - D. Laser cutting apertures with trapezoidal walls and also rounding corners will offer better paste release. Customers should contact their board assembly site for stencil design recommendations. Refer to IPC-7525 for other stencil recommendations.
 - E. Customers should contact their board fabrication site for solder mask tolerances between and around signal pads.

DB (R-PDSO-G**)

PLASTIC SMALL-OUTLINE

28 PINS SHOWN



- NOTES: A. All linear dimensions are in millimeters.
 B. This drawing is subject to change without notice.
 C. Body dimensions do not include mold flash or protrusion not to exceed 0,15.
 D. Falls within JEDEC MO-150

IMPORTANT NOTICE

Texas Instruments Incorporated and its subsidiaries (TI) reserve the right to make corrections, enhancements, improvements and other changes to its semiconductor products and services per JESD46, latest issue, and to discontinue any product or service per JESD48, latest issue. Buyers should obtain the latest relevant information before placing orders and should verify that such information is current and complete. All semiconductor products (also referred to herein as "components") are sold subject to TI's terms and conditions of sale supplied at the time of order acknowledgment.

TI warrants performance of its components to the specifications applicable at the time of sale, in accordance with the warranty in TI's terms and conditions of sale of semiconductor products. Testing and other quality control techniques are used to the extent TI deems necessary to support this warranty. Except where mandated by applicable law, testing of all parameters of each component is not necessarily performed.

TI assumes no liability for applications assistance or the design of Buyers' products. Buyers are responsible for their products and applications using TI components. To minimize the risks associated with Buyers' products and applications, Buyers should provide adequate design and operating safeguards.

TI does not warrant or represent that any license, either express or implied, is granted under any patent right, copyright, mask work right, or other intellectual property right relating to any combination, machine, or process in which TI components or services are used. Information published by TI regarding third-party products or services does not constitute a license to use such products or services or a warranty or endorsement thereof. Use of such information may require a license from a third party under the patents or other intellectual property of the third party, or a license from TI under the patents or other intellectual property of TI.

Reproduction of significant portions of TI information in TI data books or data sheets is permissible only if reproduction is without alteration and is accompanied by all associated warranties, conditions, limitations, and notices. TI is not responsible or liable for such altered documentation. Information of third parties may be subject to additional restrictions.

Resale of TI components or services with statements different from or beyond the parameters stated by TI for that component or service voids all express and any implied warranties for the associated TI component or service and is an unfair and deceptive business practice. TI is not responsible or liable for any such statements.

Buyer acknowledges and agrees that it is solely responsible for compliance with all legal, regulatory and safety-related requirements concerning its products, and any use of TI components in its applications, notwithstanding any applications-related information or support that may be provided by TI. Buyer represents and agrees that it has all the necessary expertise to create and implement safeguards which anticipate dangerous consequences of failures, monitor failures and their consequences, lessen the likelihood of failures that might cause harm and take appropriate remedial actions. Buyer will fully indemnify TI and its representatives against any damages arising out of the use of any TI components in safety-critical applications.

In some cases, TI components may be promoted specifically to facilitate safety-related applications. With such components, TI's goal is to help enable customers to design and create their own end-product solutions that meet applicable functional safety standards and requirements. Nonetheless, such components are subject to these terms.

No TI components are authorized for use in FDA Class III (or similar life-critical medical equipment) unless authorized officers of the parties have executed a special agreement specifically governing such use.

Only those TI components which TI has specifically designated as military grade or "enhanced plastic" are designed and intended for use in military/aerospace applications or environments. Buyer acknowledges and agrees that any military or aerospace use of TI components which have **not** been so designated is solely at the Buyer's risk, and that Buyer is solely responsible for compliance with all legal and regulatory requirements in connection with such use.

TI has specifically designated certain components as meeting ISO/TS16949 requirements, mainly for automotive use. In any case of use of non-designated products, TI will not be responsible for any failure to meet ISO/TS16949.

Products

Audio	www.ti.com/audio
Amplifiers	amplifier.ti.com
Data Converters	dataconverter.ti.com
DLP® Products	www.dlp.com
DSP	dsp.ti.com
Clocks and Timers	www.ti.com/clocks
Interface	interface.ti.com
Logic	logic.ti.com
Power Mgmt	power.ti.com
Microcontrollers	microcontroller.ti.com
RFID	www.ti-rfid.com
OMAP Applications Processors	www.ti.com/omap
Wireless Connectivity	www.ti.com/wirelessconnectivity

Applications

Automotive and Transportation	www.ti.com/automotive
Communications and Telecom	www.ti.com/communications
Computers and Peripherals	www.ti.com/computers
Consumer Electronics	www.ti.com/consumer-apps
Energy and Lighting	www.ti.com/energy
Industrial	www.ti.com/industrial
Medical	www.ti.com/medical
Security	www.ti.com/security
Space, Avionics and Defense	www.ti.com/space-avionics-defense
Video and Imaging	www.ti.com/video

TI E2E Community

e2e.ti.com