

TLC2654, TLC2654A

Advanced LinCMOS™ LOW-NOISE CHOPPER-STABILIZED OPERATIONAL AMPLIFIERS

SLOS020G – NOVEMBER 1988 – REVISED APRIL 2001

- **Input Noise Voltage**
 0.5 μV (Peak-to-Peak) Typ, $f = 0$ to 1 Hz
 1.5 μV (Peak-to-Peak) Typ, $f = 0$ to 10 Hz
 47 nV/ $\sqrt{\text{Hz}}$ Typ, $f = 10$ Hz
 13 nV/ $\sqrt{\text{Hz}}$ Typ, $f = 1$ kHz
- **High Chopping Frequency . . . 10 kHz Typ**
- **No Clock Noise Below 10 kHz**
- **No Intermodulation Error Below 5 kHz**
- **Low Input Offset Voltage**
 10 μV Max (TLC2654A)
- **Excellent Offset Voltage Stability**
 With Temperature . . . 0.05 $\mu\text{V}/^\circ\text{C}$ Max
- **A_{VD} . . . 135 dB Min (TLC2654A)**
- **CMRR . . . 110 dB Min (TLC2654A)**
- **k_{SVR} . . . 110 dB Min**
- **Single-Supply Operation**
- **Common-Mode Input Voltage Range**
 Includes the Negative Rail
- **No Noise Degradation With External**
Capacitors Connected to $V_{\text{DD-}}$
- **Available in Q-Temp Automotive**
HighRel Automotive Applications
Configuration Control/Print Support
Qualification to Automotive Standards

description

The TLC2654 and TLC2654A are low-noise chopper-stabilized operational amplifiers using the Advanced LinCMOS™ process. Combining this process with chopper-stabilization circuitry makes excellent dc precision possible. In addition, circuit techniques are added that give the TLC2654 and TLC2654A superior noise performance.

Chopper-stabilization techniques provide for extremely high dc precision by continuously nulling input offset voltage even during variations in temperature, time, common-mode voltage, and power-supply voltage. The high chopping frequency of the TLC2654 and TLC2654A (see Figure 1) provides excellent noise performance in a frequency spectrum from near dc to 10 kHz. In addition, intermodulation or aliasing error is eliminated from frequencies up to 5 kHz.

This high dc precision and low noise, coupled with the extremely high input impedance of the CMOS input stage, makes the TLC2654 and TLC2654A ideal choices for a broad range of applications such as low-level, low-frequency thermocouple amplifiers and strain gauges and wide-bandwidth and subsonic circuits. For applications requiring even greater dc precision, use the TLC2652 or TLC2652A devices, which have a chopping frequency of 450 Hz.

D, JG, OR P PACKAGE
(TOP VIEW)

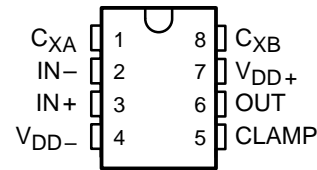

D, J, OR N PACKAGE
(TOP VIEW)

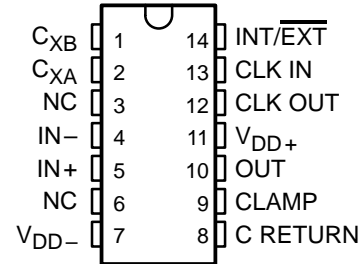

FK PACKAGE
(TOP VIEW)

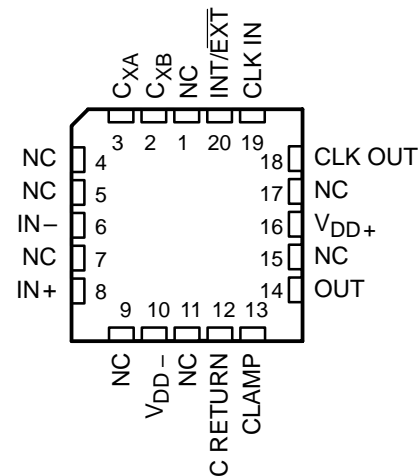

NC – No internal connection



Please be aware that an important notice concerning availability, standard warranty, and use in critical applications of Texas Instruments semiconductor products and disclaimers thereto appears at the end of this data sheet.

Advanced LinCMOS is a trademark of Texas Instruments.

PRODUCTION DATA information is current as of publication date. Products conform to specifications per the terms of Texas Instruments standard warranty. Production processing does not necessarily include testing of all parameters.



POST OFFICE BOX 655303 • DALLAS, TEXAS 75265

Copyright © 2001, Texas Instruments Incorporated
 On products compliant to MIL-PRF-38535, all parameters are tested unless otherwise noted. On all other products, production processing does not necessarily include testing of all parameters.

TLC2654, TLC2654A

Advanced LinCMOS™ LOW-NOISE CHOPPER-STABILIZED OPERATIONAL AMPLIFIERS

SLOS020G – NOVEMBER 1988 – REVISED APRIL 2001

description (continued)

The TLC2654 and TLC2654A common-mode input voltage range includes the negative rail, thereby providing superior performance in either single-supply or split-supply applications, even at power supply voltage levels as low as ± 2.3 V.

Two external capacitors are required to operate the device; however, the on-chip chopper-control circuitry is transparent to the user. On devices in the 14-pin and 20-pin packages, the control circuitry is accessible, allowing the user the option of controlling the clock frequency with an external frequency source. In addition, the clock threshold of the TLC2554 and TLC2654A requires no level shifting when used in the single-supply configuration with a normal CMOS or TTL clock input.

Innovative circuit techniques used on the TLC2654 and TLC2654A allow exceptionally fast overload recovery time. An output clamp pin is available to reduce the recovery time even further.

The device inputs and outputs are designed to withstand -100 -mA surge currents without sustaining latch-up. In addition, the TLC2654 and TLC2654A incorporate internal ESD-protection circuits that prevent functional failures at voltages up to 2000 V as tested under MIL-STD-883C, Method 3015; however, exercise care in handling these devices, as exposure to ESD may result in degradation of the device parametric performance.

The C-suffix devices are characterized for operation from 0°C to 70°C . The I-suffix devices are characterized for operation from -40°C to 85°C . The Q-suffix devices are characterized for operation from -40°C to 125°C . The M-suffix devices are characterized for operation over the full military temperature range of -55°C to 125°C .

EQUIVALENT INPUT NOISE VOLTAGE VS FREQUENCY

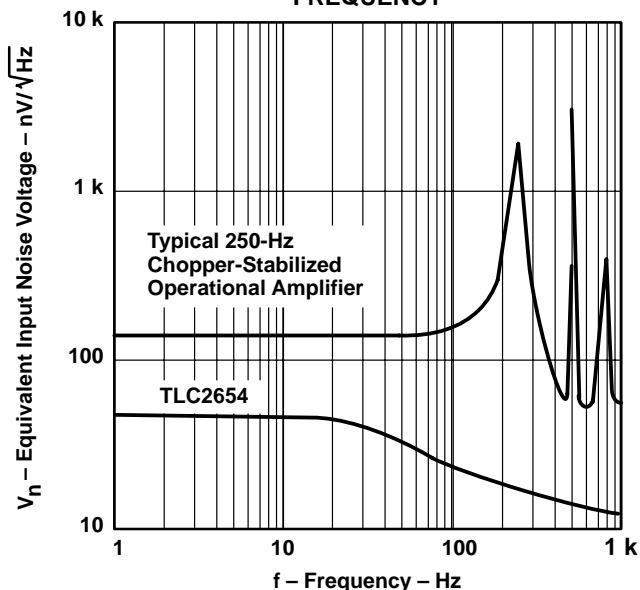

Figure 1

AVAILABLE OPTIONS

T _A	V _{IOmax} AT 25°C	PACKAGED DEVICES						
		8 PIN			14 PIN			20 PIN
		SMALL OUTLINE (D)	CERAMIC DIP (JG)	PLASTIC DIP (P)	SMALL OUTLINE (D)	CERAMIC DIP (J)	PLASTIC DIP (N)	CERAMIC DIP (FK)
0°C to 70°C	10 μV 20 mV	TLC2654AC-8D	—	TLC2654ACP	TLC2654AC-14D	—	TLC2654ACN	—
		TLC2654C-8D	—	TLC2654CP	TLC2654C-14D	—	TLC2654CN	—
-40°C to 85°C	10 μV 20 μV	TLC2654AI-8D	—	TLC2654AIP	TLC2654AI-14D	—	TLC2654AIN	—
		TLC2654I-8D	—	TLC2654IP	TLC2654I-14D	—	TLC2654IN	—
-40°C to 125°C	10 μV 20 μV	TLC2654AQ-8D	—	—	—	—	—	—
		TLC2654Q-8D	—	—	—	—	—	—
-55°C to 125°C	10 μV 20 μV	TLC2654AM-8D	TLC2654AMJG	TLC2654AMP	TLC2654AM-14D	TLC2654AMJ	TLC2654AMN	TLC2654AMFK
		TLC2654M-8D	TLC2654MJG	TLC2654MP	TLC2654M-14D	TLC2654MJ	TLC2654MN	TLC2654MFK

The 8-pin and 14-pin D packages are available taped and reeled. Add R suffix to device type (e.g., TLC2654AC-8DR).

TLC2654, TLC2654A
Advanced LinCMOS™ LOW-NOISE CHOPPER-STABILIZED
OPERATIONAL AMPLIFIERS

SLOS020G – NOVEMBER 1988 – REVISED APRIL 2001

functional block diagram

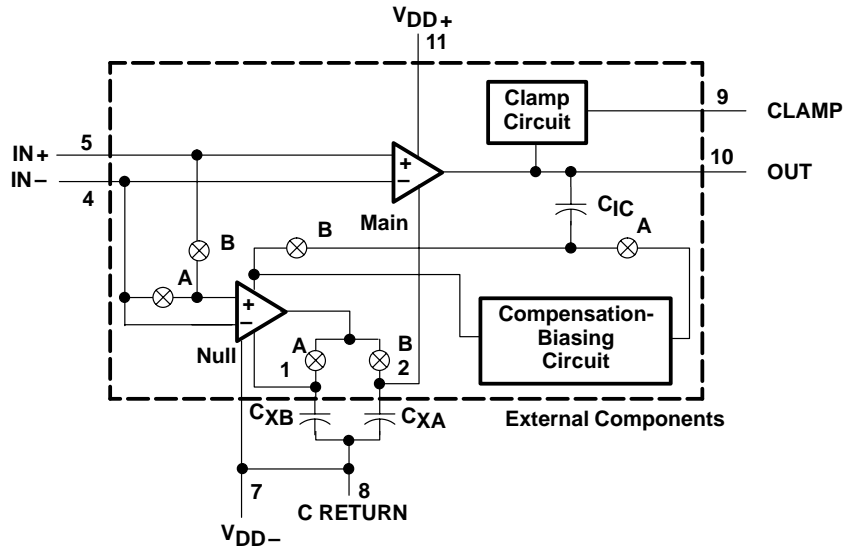

Pin numbers shown are for the D (14 pin), J, and N packages.

TLC2654, TLC2654A

Advanced LinCMOS™ LOW-NOISE CHOPPER-STABILIZED OPERATIONAL AMPLIFIERS

SLOS020G – NOVEMBER 1988 – REVISED APRIL 2001

absolute maximum ratings over operating free-air temperature range (unless otherwise noted)†

Supply voltage, V_{DD+} (see Note 1)	8 V
Supply voltage, V_{DD-} (see Note 1)	-8 V
Differential input voltage, V_{ID} (see Note 2)	± 16 V
Input voltage, V_I (any input, see Note 1)	± 8 V
Voltage range on CLK IN and INT/EXT \bar{I}	V_{DD-} to $V_{DD-} + 5.2$ V
Input current, I_I (each input)	± 5 mA
Output current, I_O	± 50 mA
Duration of short-circuit current at (or below) 25°C (see Note 3)	unlimited
Current into CLK IN and INT/EXT \bar{I}	± 5 mA
Continuous total dissipation	See Dissipation Rating Table
Operating free-air temperature range, T_A : C suffix	0°C to 70°C
I suffix	-40°C to 85°C
Q suffix	-40°C to 125°C
M suffix	-55°C to 125°C
Storage temperature range	-65°C to 150°C
Case temperature for 60 seconds: FK package	260°C
Lead temperature 1,6 mm (1/16 inch) from case for 10 seconds: D, N, or P package	260°C
Lead temperature 1,6 mm (1/16 inch) from case for 60 seconds: J or JG package	300°C

† Stresses beyond those listed under “absolute maximum ratings” may cause permanent damage to the device. These are stress ratings only, and functional operation of the device at these or any other conditions beyond those indicated under “recommended operating conditions” is not implied. Exposure to absolute-maximum-rated conditions for extended periods may affect device reliability.

- NOTES: 1. All voltage values, except differential voltages, are with respect to the midpoint between V_{DD+} and V_{DD-} .
 2. Differential voltages are at $IN+$ with respect to $IN-$.
 3. The output may be shorted to either supply. Temperature and/or supply voltages must be limited to ensure that the maximum dissipation rating is not exceeded.

DISSIPATION RATING TABLE

PACKAGE	$T_A \leq 25^\circ\text{C}$ POWER RATING	DERATING FACTOR ABOVE $T_A = 25^\circ\text{C}$	$T_A = 70^\circ\text{C}$ POWER RATING	$T_A = 85^\circ\text{C}$ POWER RATING	$T_A = 125^\circ\text{C}$ POWER RATING
D (8 pin)	725 mW	5.8 mW/°C	464 mW	377 mW	145 mW
D (14 pin)	950 mW	7.6 mW/°C	608 mW	494 mW	190 mW
FK	1375 mW	11.0 mW/°C	880 mW	715 mW	275 mW
J	1375 mW	11.0 mW/°C	880 mW	715 mW	275 mW
JG	1050 mW	8.4 mW/°C	672 mW	546 mW	210 mW
N	1150 mW	9.2 mW/°C	736 mW	598 mW	230 mW
P	1000 mW	8.0 mW/°C	640 mW	520 mW	200 mW

recommended operating conditions

	C SUFFIX		I SUFFIX		Q SUFFIX		M SUFFIX		UNIT
	MIN	MAX	MIN	MAX	MIN	MAX	MIN	MAX	
Supply voltage, $V_{DD\pm}$	± 2.3	± 8	± 2.3	± 8	± 2.3	± 8	± 2.3	± 8	V
Common-mode input voltage, V_{IC}	V_{DD-}	$V_{DD+} - 2.3$	V_{DD-}	$V_{DD+} - 2.3$	V_{DD-}	$V_{DD+} - 2.3$	V_{DD-}	$V_{DD+} - 2.3$	V
Clock input voltage	V_{DD-}	$V_{DD-} + 5$	V_{DD-}	$V_{DD-} + 5$	V_{DD-}	$V_{DD-} + 5$	V_{DD-}	$V_{DD-} + 5$	V
Operating free-air temperature, T_A	0	70	-40	85	-40	125	-55	125	°C



TLC2654, TLC2654A
Advanced LinCMOS™ LOW-NOISE CHOPPER-STABILIZED
OPERATIONAL AMPLIFIERS

SLOS020G – NOVEMBER 1988 – REVISED APRIL 2001

electrical characteristics at specified free-air temperature, $V_{DD\pm} = \pm 5$ V (unless otherwise noted)

PARAMETER	TEST CONDITIONS	T_A †	TLC2654C			TLC2654AC			UNIT	
			MIN	TYP	MAX	MIN	TYP	MAX		
V_{IO} Input offset voltage (see Note 4)	$V_{IC} = 0, R_S = 50 \Omega$	25°C	5		20	4		10	μV	
		Full range	34			24				
α_{VIO} Temperature coefficient of input offset voltage		Full range	0.01		0.05	0.01		0.05	$\mu V/^\circ C$	
Input offset voltage long-term drift (see Note 5)		25°C	0.003		0.06	0.003		0.02	$\mu V/mo$	
I_{IO} Input offset current		25°C	30		60	30		60	pA	
		Full range	150			150				
I_{IB} Input bias current		25°C	50		60	50		60	pA	
		Full range	150			150				
V_{ICR} Common-mode input voltage range		$R_S = 50 \Omega$	Full range	-5 to 2.7		-5 to 2.7				V
V_{OM+} Maximum positive peak output voltage swing		$R_L = 10 k\Omega$, See Note 6	25°C	4.7		4.8	4.7		4.8	V
	Full range		4.7			4.7				
V_{OM-} Maximum negative peak output voltage swing	$R_L = 10 k\Omega$, See Note 6	25°C	-4.7		-4.9	-4.7		-4.9	V	
		Full range	-4.7			-4.7				
A_{VD} Large-signal differential voltage amplification	$V_O = \pm 4$ V, $R_L = 10 k\Omega$	25°C	120		155	135		155	dB	
		Full range	120			130				
Internal chopping frequency		25°C	10			10			kHz	
Clamp on-state current	$R_L = 100 k\Omega$	25°C	25			25			μA	
		Full range	25			25				
Clamp off-state current	$V_O = -4$ V to 4 V	25°C	100			100			pA	
		Full range	100			100				
CMRR Common-mode rejection ratio	$V_O = 0, V_{IC} = V_{ICRmin}, R_S = 50 \Omega$	25°C	105		125	110		125	dB	
		Full range	105			110				
k_{SVR} Supply voltage rejection ratio ($\Delta V_{DD\pm}/\Delta V_{IO}$)	$V_{DD\pm} = \pm 2.3$ V to ± 8 V, $V_O = 0, R_S = 50 \Omega$	25°C	110		125	110		125	dB	
		Full range	110			110				
I_{DD} Supply current	$V_O = 0, \text{ No load}$	25°C	1.5		2.4	1.5		2.4	mA	
		Full range	2.5			2.5				

† Full range is 0°C to 70°C.

- NOTES: 4. This parameter is not production tested full range. Thermocouple effects preclude measurement of the actual V_{IO} of these devices in high-speed automated testing. V_{IO} is measured to a limit determined by the test equipment capability at the temperature extremes. The test ensures that the stabilization circuitry is performing properly.
5. Typical values are based on the input offset voltage shift observed through 168 hours of operating life test at $T_A = 150^\circ C$ extrapolated to $T_A = 25^\circ$ using the Arrhenius equation and assuming an activation energy of 0.96 eV.
6. Output clamp is not connected.



TLC2654, TLC2654A

Advanced LinCMOS™ LOW-NOISE CHOPPER-STABILIZED OPERATIONAL AMPLIFIERS

SLOS020G – NOVEMBER 1988 – REVISED APRIL 2001

operating characteristics at specified free-air temperature, $V_{DD\pm} = \pm 5\text{ V}$

PARAMETER	TEST CONDITIONS	T _A †	TLC2654C			TLC2654AC			UNIT
			MIN	TYP	MAX	MIN	TYP	MAX	
SR+ Positive slew rate at unity gain	V _O = ±2.3 V, R _L = 10 kΩ, C _L = 100 pF	25°C	1.5	2		1.5	2		V/μs
		Full range	1.3			1.3			
SR– Negative slew rate at unity gain	V _O = ±2.3 V, R _L = 10 kΩ, C _L = 100 pF	25°C	2.3	3.7		2.3	3.7		V/μs
		Full range	1.7			1.7			
V _n Equivalent input noise voltage (see Note 7)	f = 10 Hz	25°C	47			47	75	nV/√Hz	
	f = 1 kHz		13			13	20		
V _{N(PP)} Peak-to-peak equivalent input noise voltage	f = 0 to 1 Hz	25°C	0.5			0.5		μV	
	f = 0 to 10 Hz		1.5			1.5			
I _n Equivalent input noise current	f = 10 kHz	25°C	0.004			0.004		pA/√Hz	
Gain-bandwidth product	f = 10 kHz, R _L = 10 kΩ, C _L = 100 pF	25°C	1.9			1.9		MHz	
φ _m Phase margin at unity gain	R _L = 10 kΩ, C _L = 100 pF	25°C	48°			48°			

† Full range is 0°C to 70°C.

NOTE 7: This parameter is tested on a sample basis for the TLC2654A. For other test requirements, please contact the factory. This statement has no bearing on testing or nontesting of other parameters.



TLC2654, TLC2654A
Advanced LinCMOS™ LOW-NOISE CHOPPER-STABILIZED
OPERATIONAL AMPLIFIERS

SLOS020G – NOVEMBER 1988 – REVISED APRIL 2001

electrical characteristics at specified free-air temperature, $V_{DD\pm} = \pm 5$ V (unless otherwise noted)

PARAMETER	TEST CONDITIONS	T_A †	TLC2654I			TLC2654AI			UNIT
			MIN	TYP	MAX	MIN	TYP	MAX	
V_{IO} Input offset voltage (see Note 4)	$V_{IC} = 0, R_S = 50 \Omega$	25°C	5	20		4	10	μV	
		Full range			40		30		
α_{VIO} Temperature coefficient of input offset voltage		Full range	0.01	0.05		0.01	0.05	$\mu V/^\circ C$	
Input offset voltage long-term drift (see Note 5)		25°C	0.003	0.06		0.003	0.02	$\mu V/mo$	
I_{IO} Input offset current		25°C	30	60		30	60	pA	
		Full range			200		200		
I_{IB} Input bias current		25°C	50	60		50	60	pA	
		Full range			200		200		
V_{ICR} Common-mode input voltage range	$R_S = 50 \Omega$	Full range	-5 to 2.7		-5 to 2.7		V		
V_{OM+} Maximum positive peak output voltage swing	$R_L = 10 k\Omega$, See Note 6	25°C	4.7	4.8		4.7	4.8	V	
		Full range	4.7			4.7			
V_{OM-} Maximum negative peak output voltage swing	$R_L = 10 k\Omega$, See Note 6	25°C	-4.7	-4.9		-4.7	-4.9	V	
		Full range	-4.7			-4.7			
A_{VD} Large-signal differential voltage amplification	$V_O = \pm 4$ V, $R_L = 10 k\Omega$	25°C	120	155		135	155	dB	
		Full range	120			125			
Internal chopping frequency		25°C	10			10	kHz		
Clamp on-state current	$R_L = 100 k\Omega$	25°C	25			25		μA	
		Full range	25			25			
Clamp off-state current	$V_O = -4$ V to 4 V	25°C		100			100	pA	
		Full range		100			100		
CMRR Common-mode rejection ratio	$V_O = 0, V_{IC} = V_{ICRmin}, R_S = 50 \Omega$	25°C	105	125		110	125	dB	
		Full range	105			110			
k_{SVR} Supply voltage rejection ratio ($\Delta V_{DD\pm}/\Delta V_{IO}$)	$V_{DD\pm} = \pm 2.3$ V to ± 8 V, $V_O = 0, R_S = 50 \Omega$	25°C	110	125		110	125	dB	
		Full range	110			110			
I_{DD} Supply current	$V_O = 0, \text{ No load}$	25°C	1.5	2.4		1.5	2.4	mA	
		Full range			2.5		2.5		

† Full range is $-40^\circ C$ to $85^\circ C$

- NOTES:
- This parameter is not production tested full range. Thermocouple effects preclude measurement of the actual V_{IO} of these devices in high-speed automated testing. V_{IO} is measured to a limit determined by the test equipment capability at the temperature extremes. The test ensures that the stabilization circuitry is performing properly.
 - Typical values are based on the input offset voltage shift observed through 168 hours of operating life test at $T_A = 150^\circ C$ extrapolated to $T_A = 25^\circ C$ using the Arrhenius equation and assuming an activation energy of 0.96 eV.
 - Output clamp is not connected.



TLC2654, TLC2654A

Advanced LinCMOS™ LOW-NOISE CHOPPER-STABILIZED OPERATIONAL AMPLIFIERS

SLOS020G – NOVEMBER 1988 – REVISED APRIL 2001

operating characteristics at specified free-air temperature, $V_{DD\pm} = \pm 5\text{ V}$

PARAMETER	TEST CONDITIONS	T _A †	TLC2654I			TLC2654AI			UNIT
			MIN	TYP	MAX	MIN	TYP	MAX	
SR+	Positive slew rate at unity gain	V _O = ±2.3 V, R _L = 10 kΩ, C _L = 100 pF	25°C	1.5	2		1.5	2	V/μs
			Full range	1.2			1.2		
SR–	Negative slew rate at unity gain	V _O = ±2.3 V, R _L = 10 kΩ, C _L = 100 pF	25°C	2.3	3.7		2.3	3.7	V/μs
			Full range	1.5			1.5		
V _n	Equivalent input noise voltage (see Note 7)	f = 10 Hz f = 1 kHz	25°C		47		47	75	nV/√Hz
					13		13	20	
V _{N(PP)}	Peak-to-peak equivalent input noise voltage	f = 0 to 1 Hz	25°C		0.5		0.5	μV	
		f = 0 to 10 Hz			1.5		1.5		
I _n	Equivalent input noise current	f = 10 kHz	25°C		0.004		0.004	pA/√Hz	
	Gain-bandwidth product	f = 10 kHz, R _L = 10 kΩ, C _L = 100 pF	25°C		1.9		1.9	MHz	
φ _m	Phase margin at unity gain	R _L = 10 kΩ, C _L = 100 pF	25°C		48°		48°		

† Full range is –40°C to 85°C.

NOTE 7: This parameter is tested on a sample basis for the TLC2654A. For other test requirements, please contact the factory. This statement has no bearing on testing or nontesting of other parameters.



TLC2654, TLC2654A
Advanced LinCMOS™ LOW-NOISE CHOPPER-STABILIZED
OPERATIONAL AMPLIFIERS

SLOS020G – NOVEMBER 1988 – REVISED APRIL 2001

electrical characteristics at specified free-air temperature, $V_{DD} = \pm 5$ V (unless otherwise noted)

PARAMETER	TEST CONDITIONS	T_A †	TLC2654Q TLC2654M			TLC2654AQ TLC2654AM			UNIT
			MIN	TYP	MAX	MIN	TYP	MAX	
V_{IO} Input offset voltage (see Note 4)	$V_{IC} = 0, R_S = 50 \Omega$	25°C	5 20		4 10		μV		
		Full range	50		40				
α_{VIO} Temperature coefficient of input offset voltage		Full range	0.01	0.05*	0.01	0.05*	$\mu V/^\circ C$		
Input offset voltage long-term drift (see Note 5)		25°C	0.003	0.06*	0.003	0.02*	$\mu V/mo$		
I_{IO} Input offset current		25°C	30 60		30 60		pA		
		Full range	500		500				
I_{IB} Input bias current		25°C	50 60		50 60		pA		
		Full range	500		500				
V_{ICR} Common-mode input voltage range	$R_S = 50 \Omega$	Full range	-5 to 2.7		-5 to 2.7		V		
V_{OM+} Maximum positive peak output voltage swing	$R_L = 10 k\Omega$, See Note 6	25°C	4.7	4.8	4.7	4.8	V		
		Full range	4.7		4.7				
V_{OM-} Maximum negative peak output voltage swing	$R_L = 10 k\Omega$, See Note 6	25°C	-4.7	-4.9	-4.7	-4.9	V		
		Full range	-4.7		-4.7				
A_{VD} Large-signal differential voltage amplification	$V_O = \pm 4$ V, $R_L = 10 k\Omega$	25°C	120	155	135	155	dB		
		Full range	120		120				
Internal chopping frequency		25°C	10		10		kHz		
Clamp on-state current	$R_L = 100 k\Omega$	25°C	25		25		μA		
		Full range	25		25				
Clamp off-state current	$V_O = -4$ V to 4 V	25°C	100		100		pA		
		Full range	500		500				
CMRR Common-mode rejection ratio	$V_O = 0, V_{IC} = V_{ICRmin}, R_S = 50 \Omega$	25°C	105	125	110	125	dB		
		Full range	105		110				
k_{SVR} Supply voltage rejection ratio ($\Delta V_{DD} / \Delta V_{IO}$)	$V_{DD} = \pm 2.3$ V to ± 8 V, $V_O = 0, R_S = 50 \Omega$	25°C	110	125	110	125	dB		
		Full range	105		110				
I_{DD} Supply current	$V_O = 0, \text{ No load}$	25°C	1.5 2.4		1.5 2.4		mA		
		Full range	2.5		2.5				

* On products complaint to MIL-STD-883, Class B, this parameter is not production tested.

† Full range is -40° to $125^\circ C$ for Q suffix, -55° to $125^\circ C$ for M suffix.

- NOTES:
- This parameter is not production tested full range. Thermocouple effects preclude measurement of the actual V_{IO} of these devices in high-speed automated testing. V_{IO} is measured to a limit determined by the test equipment capability at the temperature extremes. The test ensures that the stabilization circuitry is performing properly.
 - Typical values are based on the input offset voltage shift observed through 168 hours of operating life test at $T_A = 150^\circ C$ extrapolated to $T_A = 25^\circ C$ using the Arrhenius equation and assuming an activation energy of 0.96 eV.
 - Output clamp is not connected.



TLC2654, TLC2654A
Advanced LinCMOS™ LOW-NOISE CHOPPER-STABILIZED
OPERATIONAL AMPLIFIERS

SLOS020G – NOVEMBER 1988 – REVISED APRIL 2001

operating characteristics at specified free-air temperature, $V_{DD\pm} = \pm 5\text{ V}$

PARAMETER	TEST CONDITIONS	T_A †	TLC2654Q TLC2654M TLC2654AQ TLC2654AM			UNIT
			MIN	TYP	MAX	
SR+ Positive slew rate at unity gain	$V_O = \pm 2.3\text{ V}$, $R_L = 10\text{ k}\Omega$, $C_L = 100\text{ pF}$	25°C	1.5	2		V/ μ s
		Full range	1.1			
SR– Negative slew rate at unity gain		25°C	2.3	3.7		V/ μ s
		Full range	1.3			
V_n Equivalent input noise voltage	f = 10 Hz	25°C	47		nV/ $\sqrt{\text{Hz}}$	
	f = 1 kHz	25°C	13			
$V_{N(PP)}$ Peak-to-peak equivalent input noise voltage	f = 0 to 1 Hz	25°C	0.5		μ V	
	f = 0 to 10 Hz	25°C	1.5			
I_n Equivalent input noise current	f = 1 kHz	25°C	0.004		pA/ $\sqrt{\text{Hz}}$	
Gain-bandwidth product	f = 10 kHz, $R_L = 10\text{ k}\Omega$, $C_L = 100\text{ pF}$	25°C	1.9		MHz	
ϕ_m Phase margin at unity gain	$R_L = 10\text{ k}\Omega$, $C_L = 100\text{ pF}$	25°C	48°			

† Full range is -40° to 125°C for Q suffix, -55° to 125°C for M suffix.



TYPICAL CHARACTERISTICS

Table of Graphs

			FIGURE
V_{IO}	Input offset voltage	Distribution	2
	Normalized input offset voltage	vs Chopping frequency	3
I_{IO}	Input offset current	vs Chopping frequency	4
		vs Free-air temperature	5
I_{IB}	Input bias current	vs Common-mode input voltage	6
		vs Chopping frequency	7
		vs Free-air temperature	8
	Clamp current	vs Output voltage	9
V_{OM}	Maximum peak output voltage swing	vs Output current	10
		vs Free-air temperature	11
$V_{O(PP)}$	Maximum peak-to-peak output voltage swing	vs Frequency	12
CMRR	Common-mode rejection ratio	vs Frequency	13
A_{VD}	Large-signal differential voltage amplification	vs Frequency	14
		vs Free-air temperature	15
	Chopping frequency	vs Supply voltage	16
		vs Free-air temperature	17
I_{DD}	Supply current	vs Supply voltage	18
		vs Free-air temperature	19
I_{OS}	Short-circuit output current	vs Supply voltage	20
		vs Free-air temperature	21
SR	Slew rate	vs Supply voltage	22
		vs Free-air temperature	23
	Voltage-follower pulse response	Small signal	24
		Large signal	25
$V_{N(PP)}$	Peak-to-peak input noise voltage	vs Chopping frequency	26, 27
V_n	Equivalent input noise voltage	vs Frequency	28
k_{SVR}	Supply voltage rejection ratio	vs Frequency	29
	Gain-bandwidth product	vs Supply voltage	30
		vs Free-air temperature	31
ϕ_m	Phase margin	vs Supply voltage	32
		vs Load capacitance	33
	Phase shift	vs Frequency	14

TLC2654, TLC2654A
Advanced LinCMOS™ LOW-NOISE CHOPPER-STABILIZED
OPERATIONAL AMPLIFIERS

SLOS020G – NOVEMBER 1988 – REVISED APRIL 2001

TYPICAL CHARACTERISTICS†

**DISTRIBUTION OF TLC2654
 INPUT OFFSET VOLTAGE**

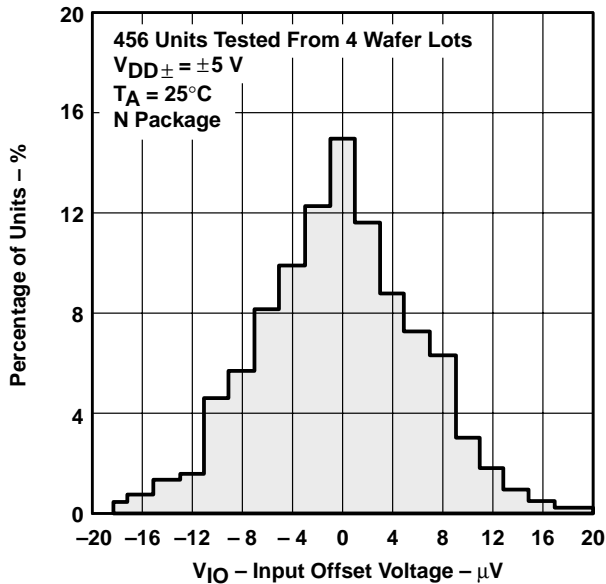

Figure 2

**NORMALIZED INPUT OFFSET VOLTAGE
 vs
 CHOPPING FREQUENCY**

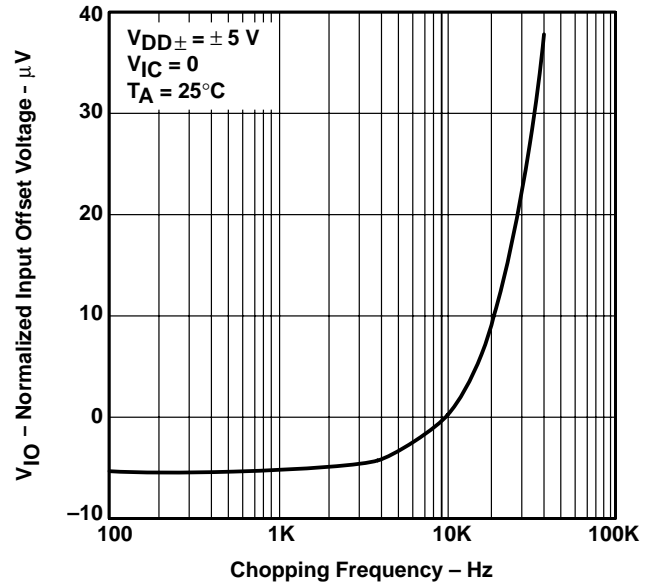

Figure 3

**INPUT OFFSET CURRENT
 vs
 CHOPPING FREQUENCY**

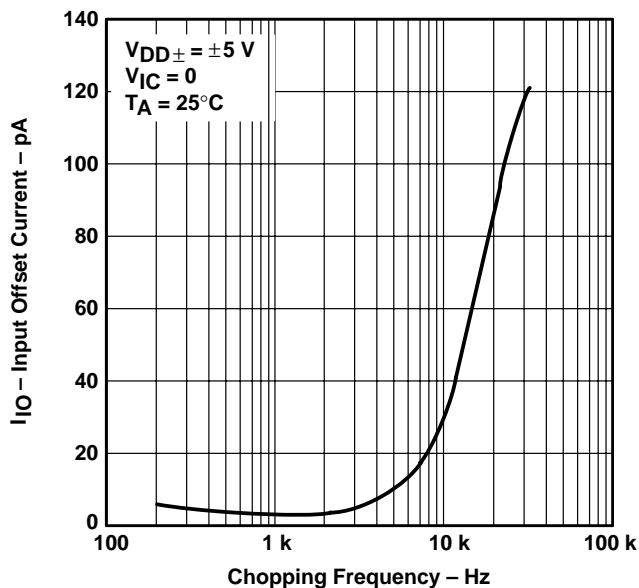

Figure 4

**INPUT OFFSET CURRENT
 vs
 FREE-AIR TEMPERATURE**

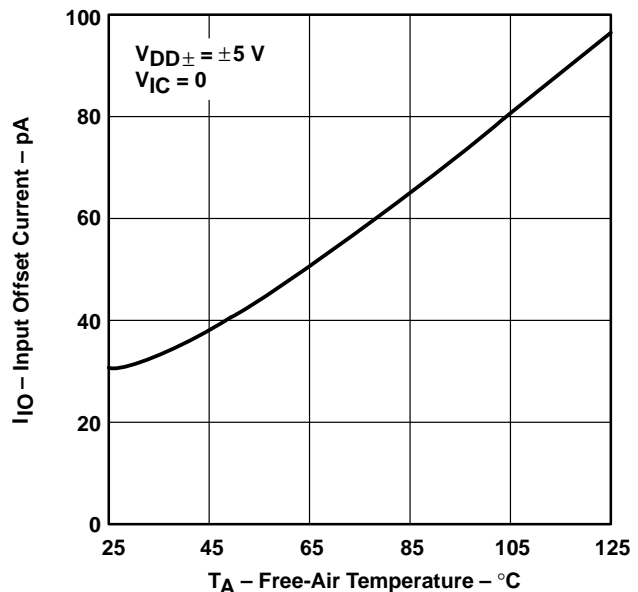

Figure 5

† Data at high and low temperatures are applicable only within the rated operating free-air temperature ranges of the various devices.



TYPICAL CHARACTERISTICS†

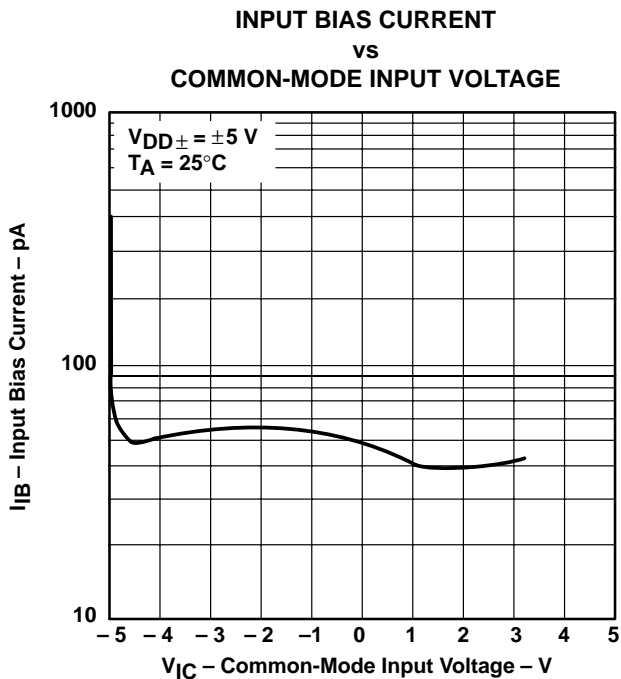

Figure 6

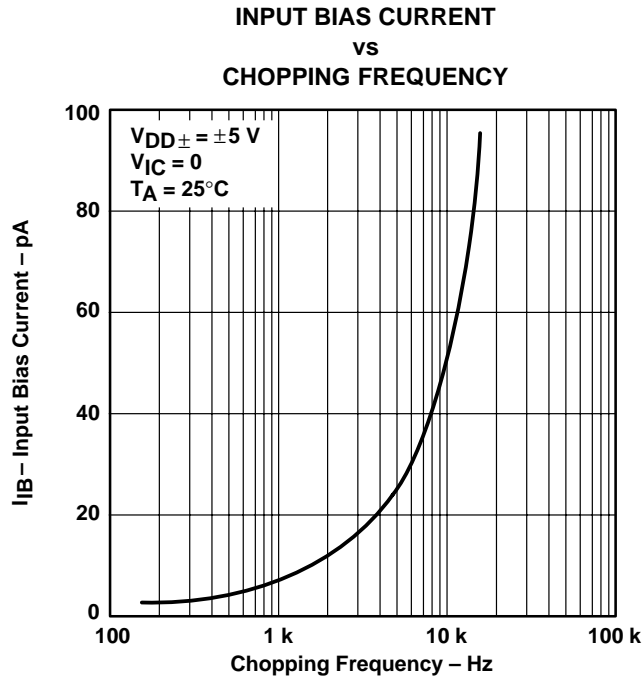

Figure 7

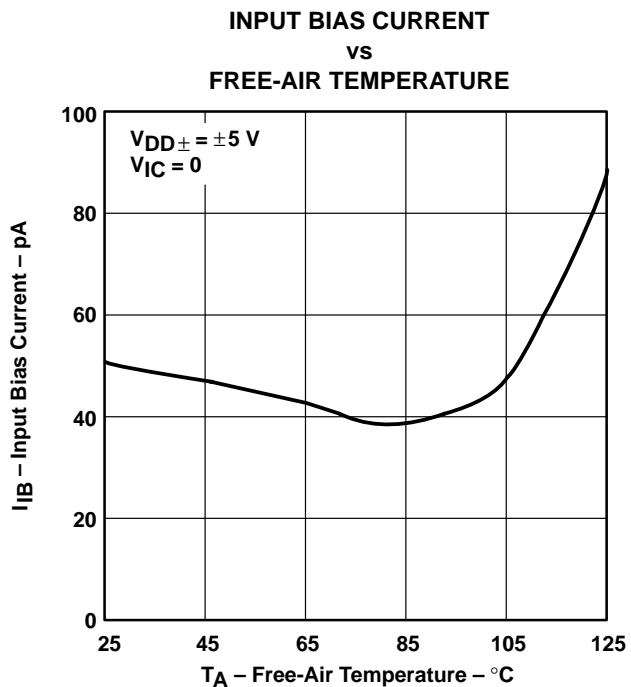

Figure 8

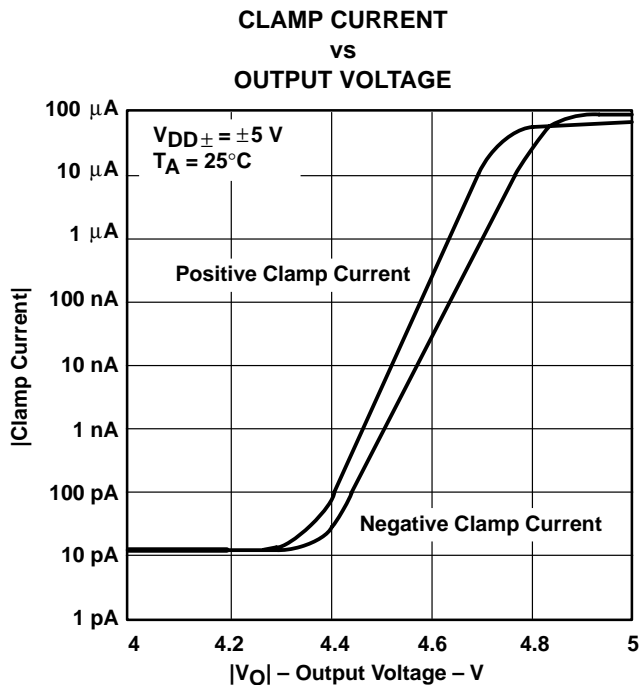

Figure 9

† Data at high and low temperatures are applicable only within the rated operating free-air temperature ranges of the various devices.

TLC2654, TLC2654A
Advanced LinCMOS™ LOW-NOISE CHOPPER-STABILIZED
OPERATIONAL AMPLIFIERS

SLOS020G – NOVEMBER 1988 – REVISED APRIL 2001

TYPICAL CHARACTERISTICS†

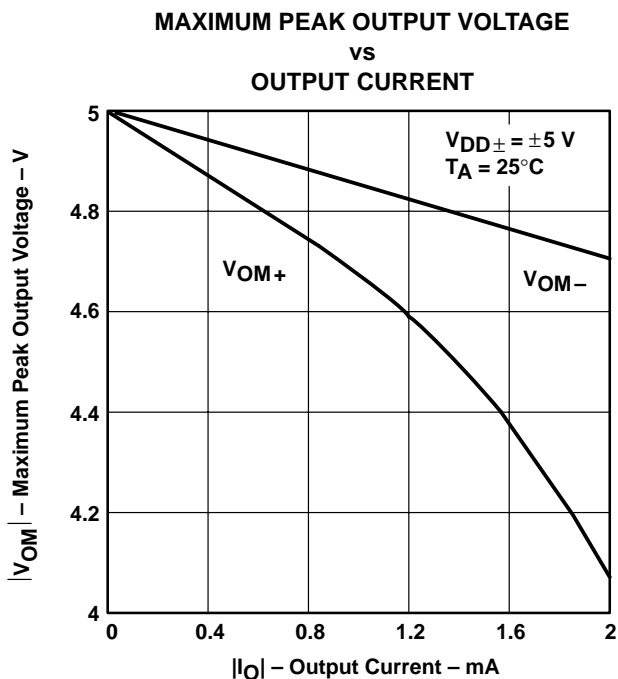

Figure 10

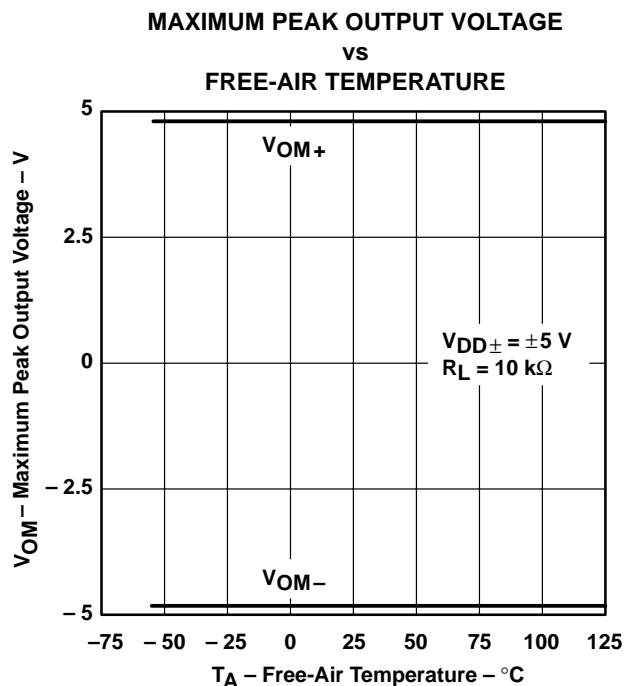

Figure 11

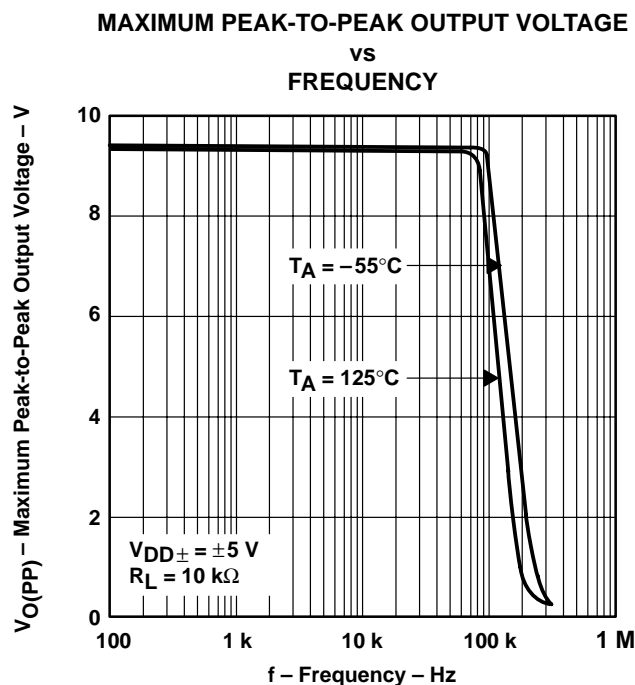

Figure 12

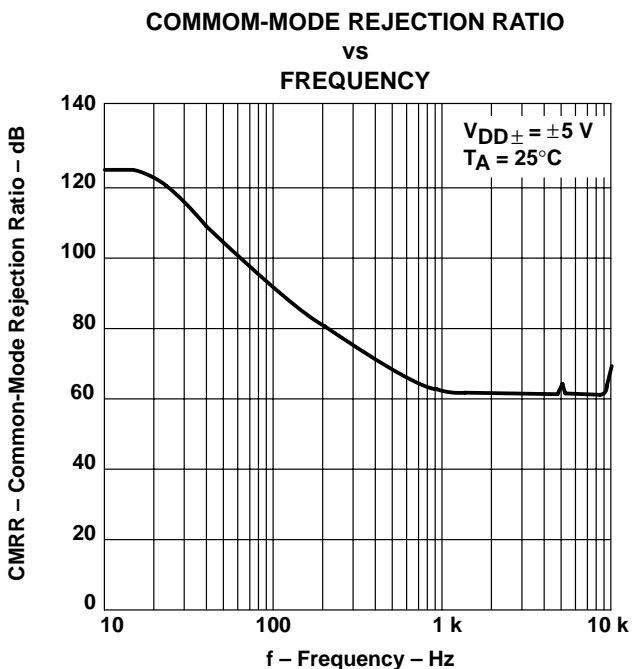

Figure 13

† Data at high and low temperatures are applicable only within the rated operating free-air temperature ranges of the various devices.



TYPICAL CHARACTERISTICS†

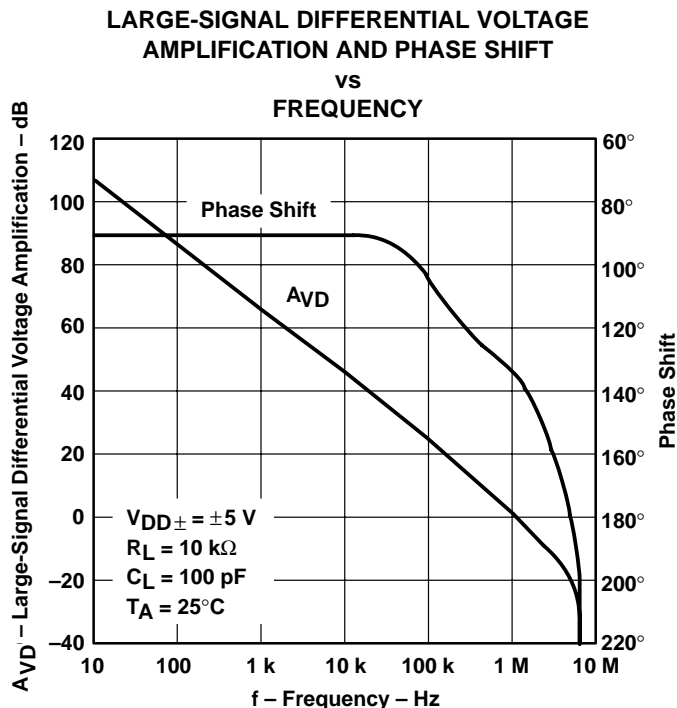

Figure 14

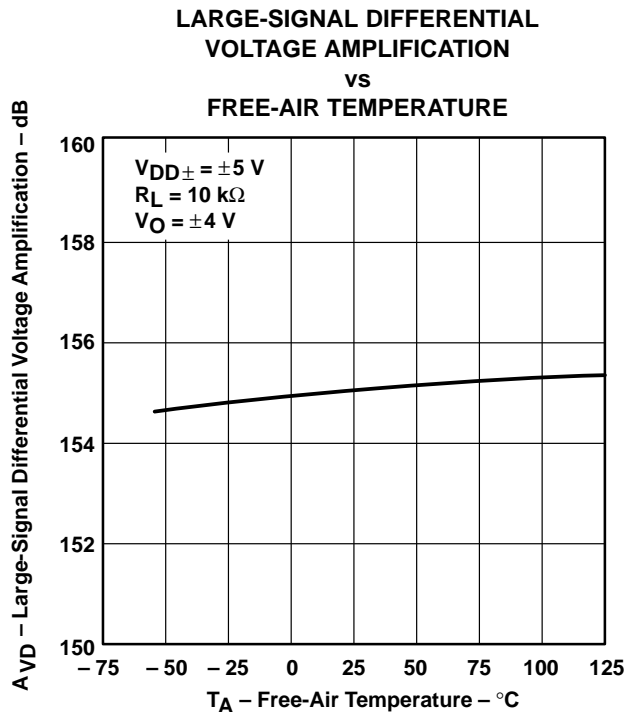

Figure 15

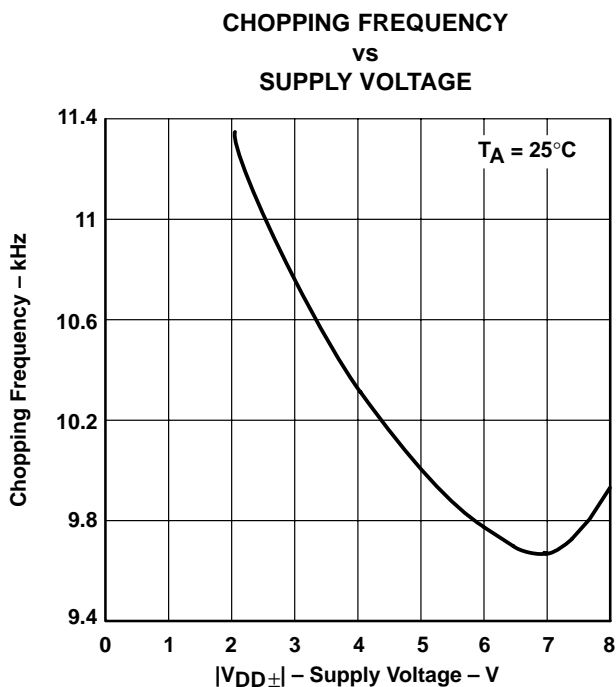

Figure 16

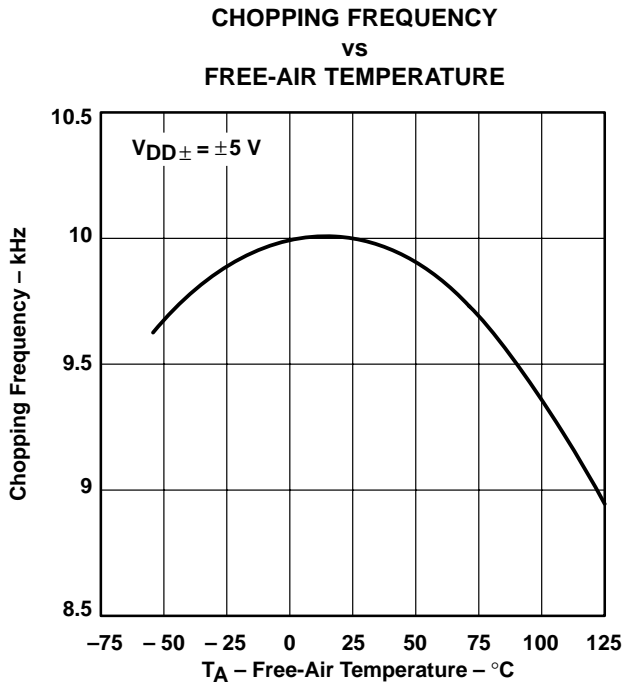

Figure 17

† Data at high and low temperatures are applicable only within the rated operating free-air temperature ranges of the various devices.

TLC2654, TLC2654A
Advanced LinCMOS™ LOW-NOISE CHOPPER-STABILIZED
OPERATIONAL AMPLIFIERS

SLOS020G – NOVEMBER 1988 – REVISED APRIL 2001

TYPICAL CHARACTERISTICS†

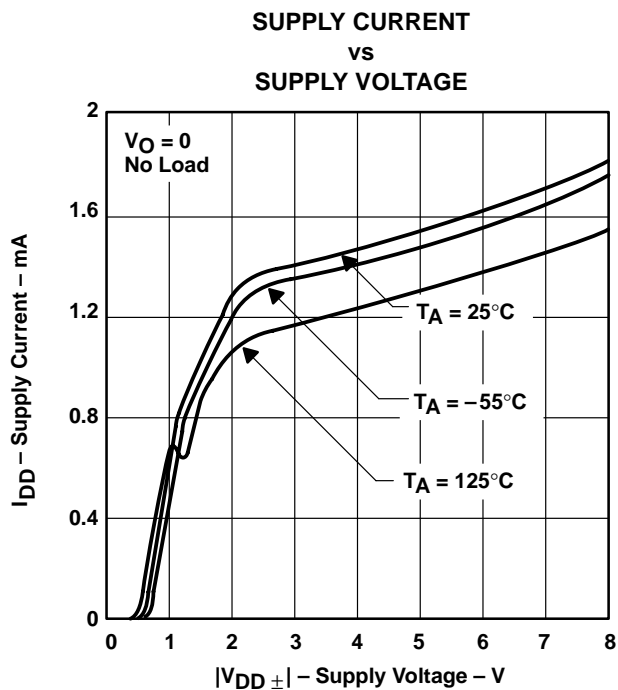

Figure 18

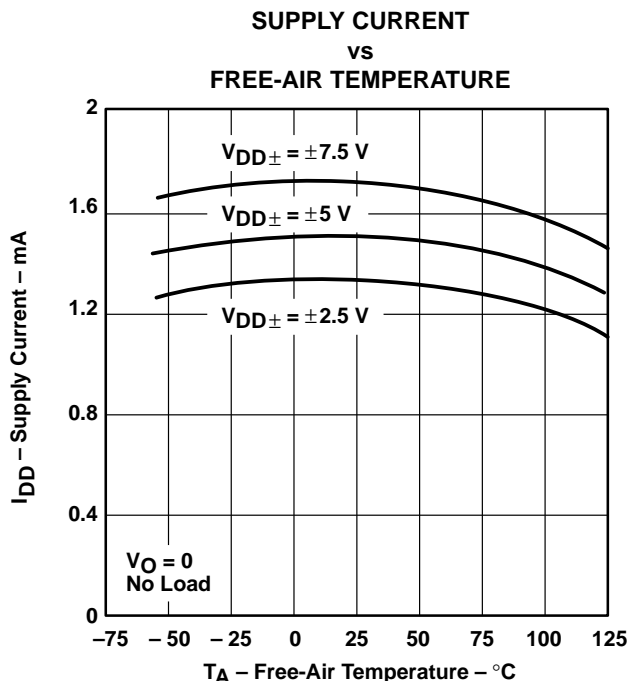

Figure 19

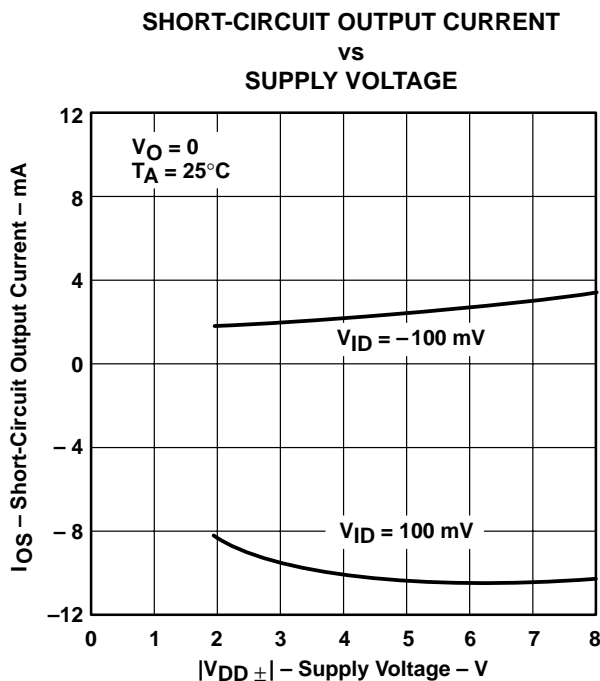

Figure 20

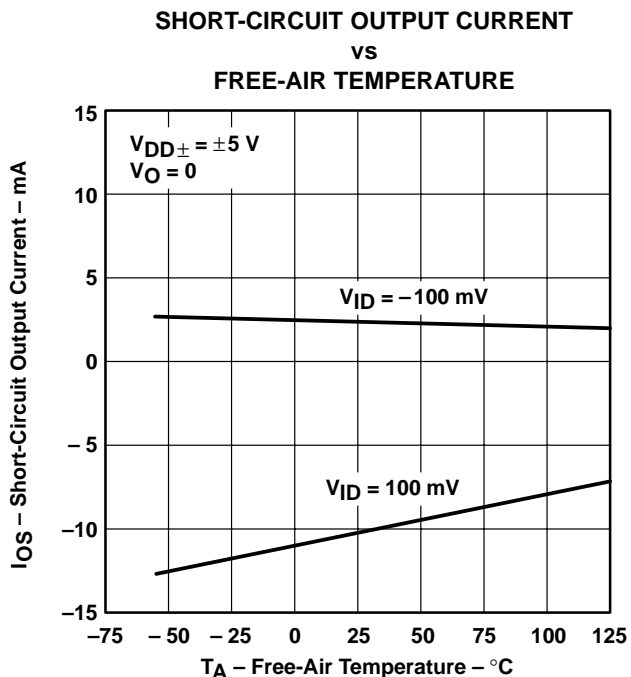
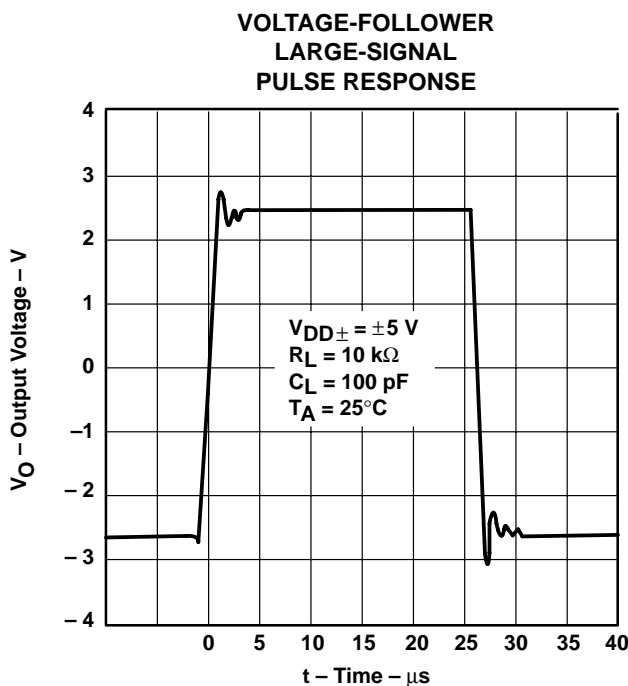
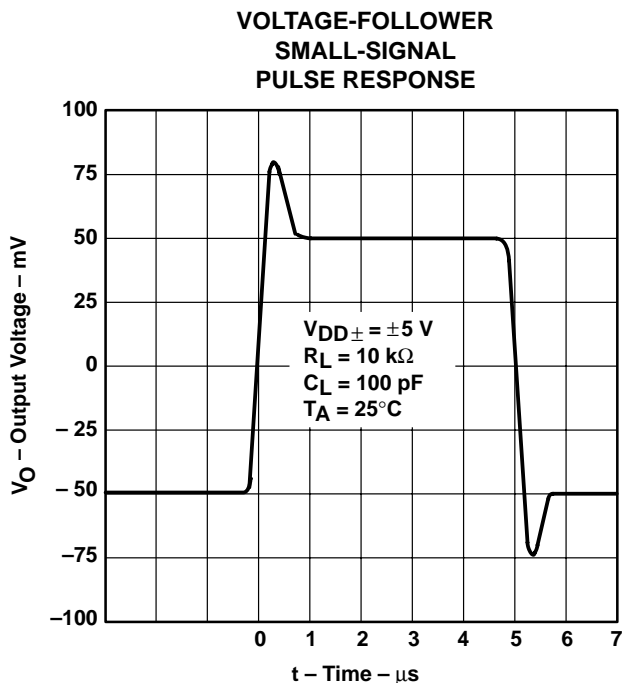
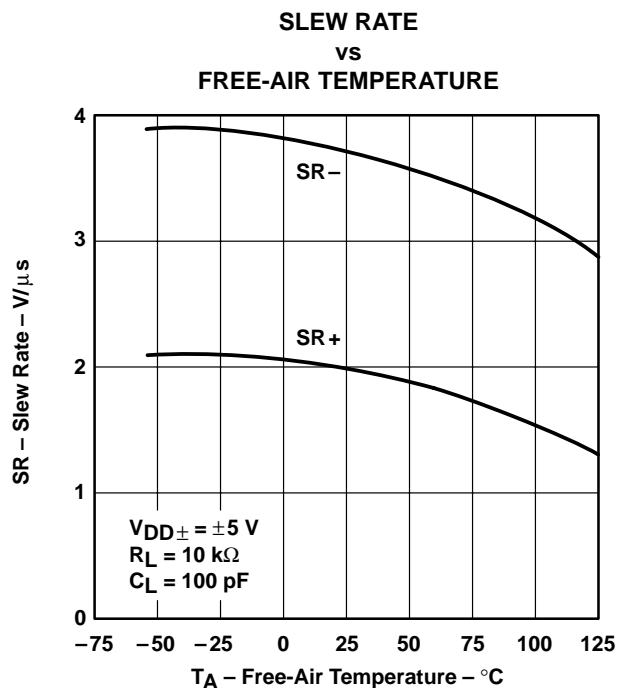
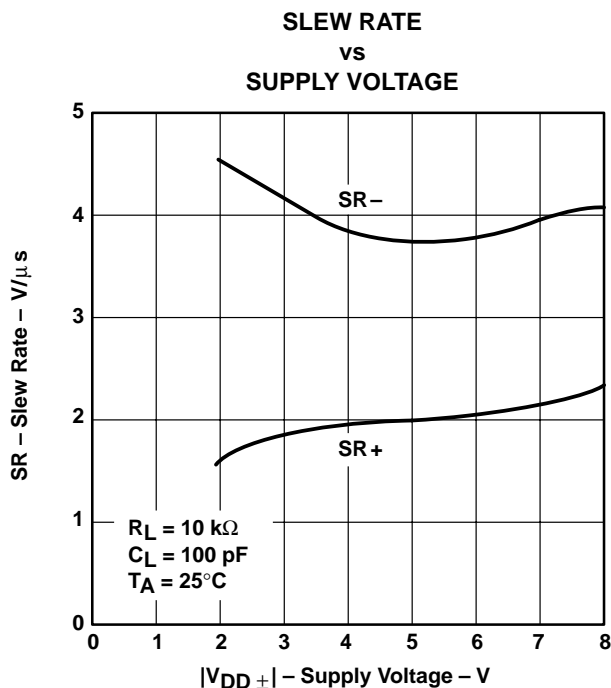

Figure 21

† Data at high and low temperatures are applicable only within the rated operating free-air temperature ranges of the various devices.



TYPICAL CHARACTERISTICS†



† Data at high and low temperatures are applicable only within the rated operating free-air temperature ranges of the various devices.

TLC2654, TLC2654A
Advanced LinCMOS™ LOW-NOISE CHOPPER-STABILIZED
OPERATIONAL AMPLIFIERS

SLOS020G – NOVEMBER 1988 – REVISED APRIL 2001

TYPICAL CHARACTERISTICS

**PEAK-TO-PEAK INPUT NOISE VOLTAGE
 vs
 CHOPPING FREQUENCY**

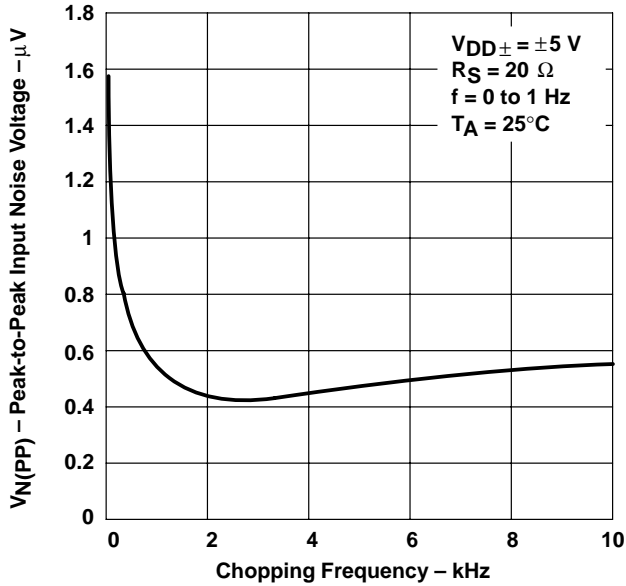

Figure 26

**PEAK-TO-PEAK INPUT NOISE VOLTAGE
 vs
 CHOPPING FREQUENCY**

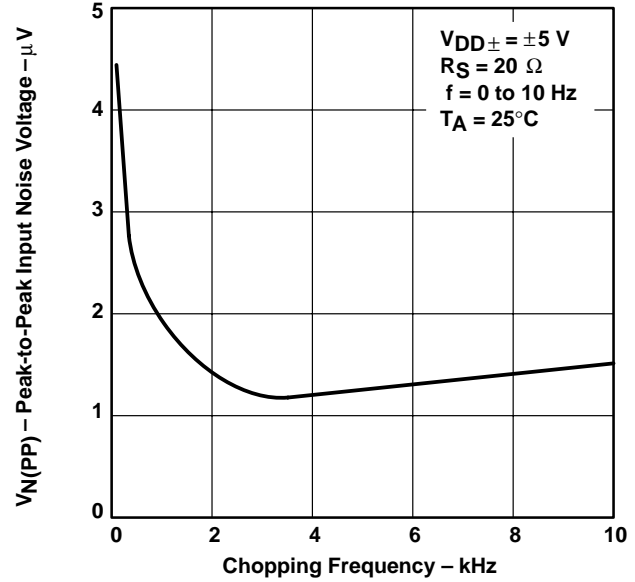

Figure 27

**EQUIVALENT INPUT NOISE VOLTAGE
 vs
 FREQUENCY**

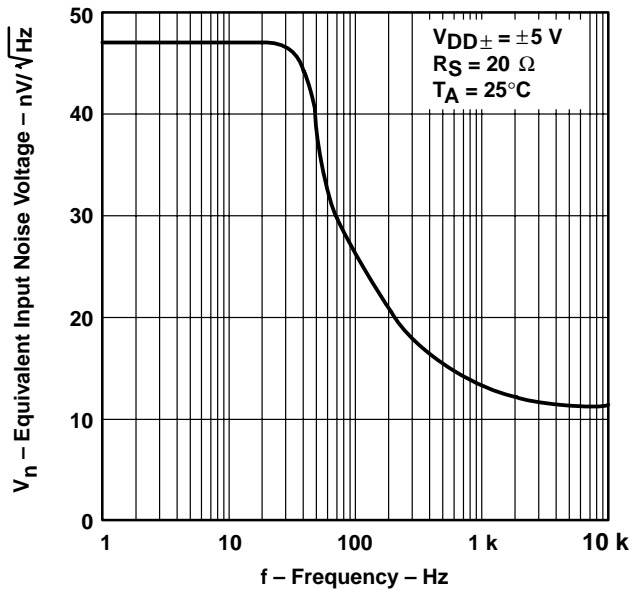

Figure 28

**SUPPLY VOLTAGE REJECTION RATIO
 vs
 FREQUENCY**

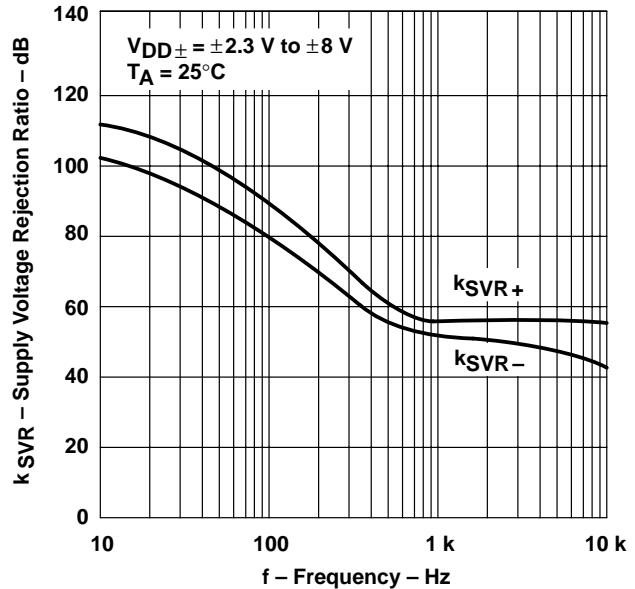

Figure 29



TYPICAL CHARACTERISTICS†

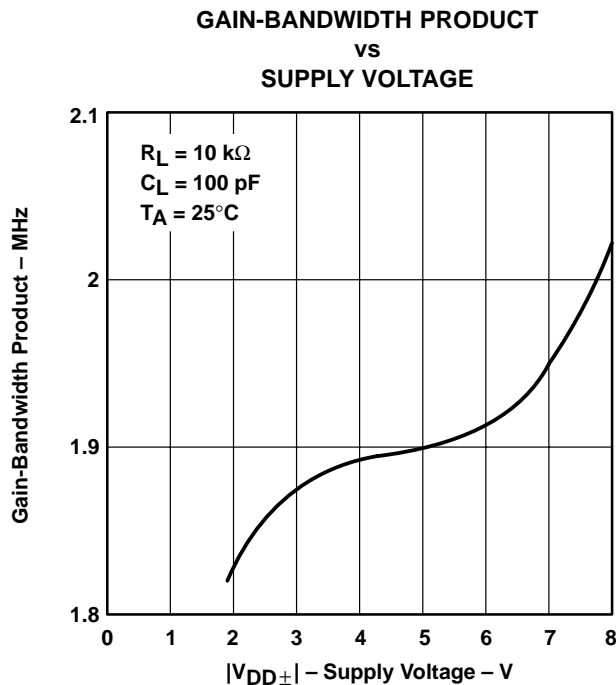

Figure 30

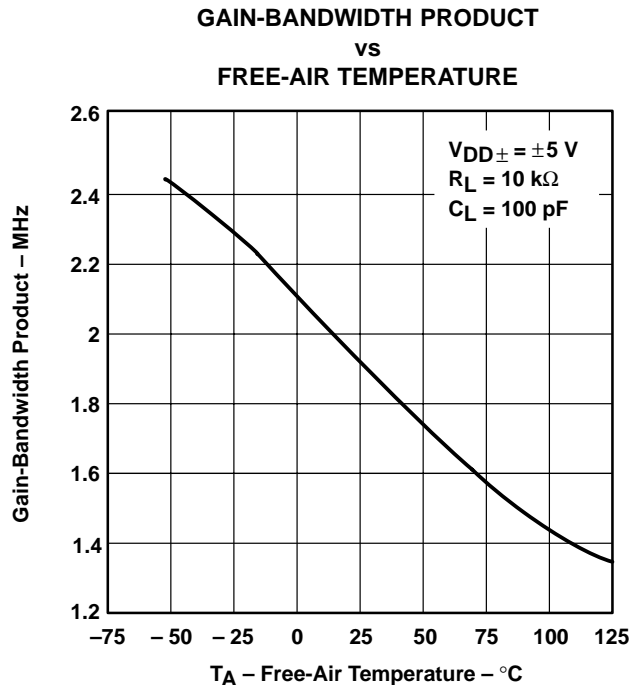

Figure 31

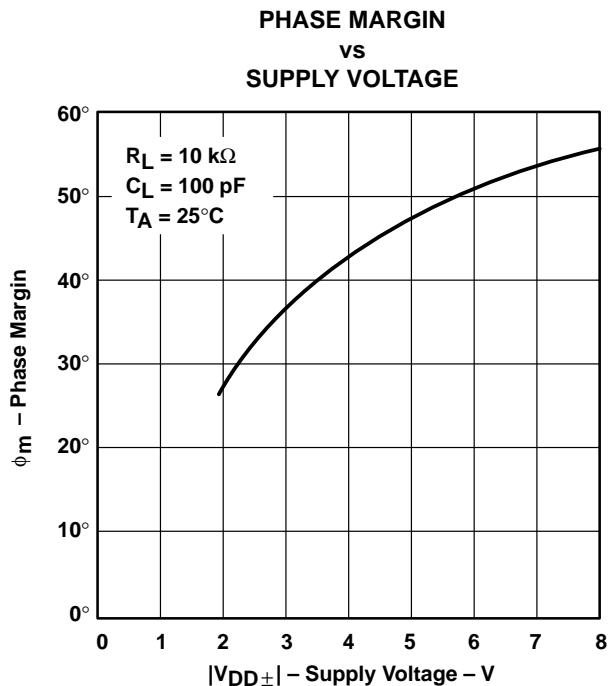

Figure 32

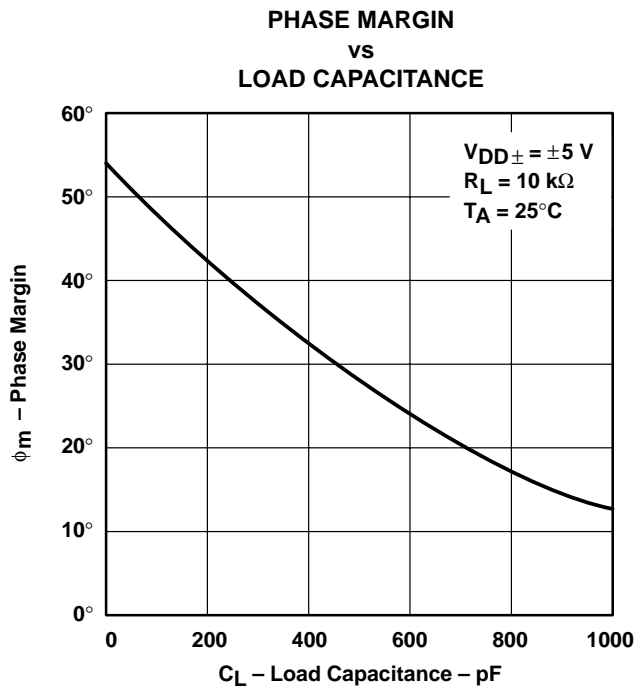

Figure 33

† Data at high and low temperatures are applicable only within the rated operating free-air temperature ranges of the various devices.

APPLICATION INFORMATION

capacitor selection and placement

Leakage and dielectric absorption are the two important factors to consider when selecting external capacitors C_{XA} and C_{XB} . Both factors can cause system degradation, negating the performance advantages realized by using the TLC2654.

Degradation from capacitor leakage becomes more apparent with increasing temperatures. Low-leakage capacitors and standoffs are recommended for operation at $T_A = 125^\circ\text{C}$. In addition, guard bands are recommended around the capacitor connections on both sides of the printed-circuit board to alleviate problems caused by surface leakage on circuit boards.

Capacitors with high dielectric absorption tend to take several seconds to settle upon application of power, which directly affects input offset voltage. In applications needing fast settling of input voltage, high-quality film capacitors such as mylar, polystyrene, or polypropylene should be used. In other applications, a ceramic or other low-grade capacitor can suffice.

Unlike many choppers available today, the TLC2654 is designed to function with values of C_{XA} and C_{XB} in the range of $0.1\ \mu\text{F}$ to $1\ \mu\text{F}$ without degradation to input offset voltage or input noise voltage. These capacitors should be located as close as possible to C_{XA} and C_{XB} and return to either V_{DD-} or C RETURN. On many choppers, connecting these capacitors to V_{DD-} causes degradation in noise performance; this problem is eliminated on the TLC2654.

internal/external clock

The TLC2654 has an internal clock that sets the chopping frequency to a nominal value of 10 kHz. On 8-pin packages, the chopping frequency can only be controlled by the internal clock; however, on all 14-pin packages and the 20-pin FK package the device chopping frequency can be set by the internal clock or controlled externally by use of the $\text{INT}/\overline{\text{EXT}}$ and CLK IN. To use the internal 10-kHz clock, no connection is necessary. If external clocking is desired, connect $\text{INT}/\overline{\text{EXT}}$ to V_{DD-} and the external clock to CLK IN. The external clock trip point is 2.5 V above the negative rail; however, CLK IN can be driven from the negative rail to 5 V above the negative rail. This allows the TLC2654 to be driven directly by 5-V TTL and CMOS logic when operating in the single-supply configuration. If this 5-V level is exceeded, damage could occur to the device unless the current into CLK IN is limited to $\pm 5\ \text{mA}$. A divide-by-two frequency divider interfaces with CLK IN and sets the chopping frequency. The chopping frequency appears on CLK OUT.

overload recovery/output clamp

When large differential-input-voltage conditions are applied to the TLC2654, the nulling loop attempts to prevent the output from saturating by driving C_{XA} and C_{XB} to internally-clamped voltage levels. Once the overdrive condition is removed, a period of time is required to allow the built-up charge to dissipate. This time period is defined as overload recovery time (see Figure 34). Typical overload recovery time for the TLC2654 is significantly faster than competitive products; however, this time can be reduced further by use of internal clamp circuitry accessible through CLAMP if required.

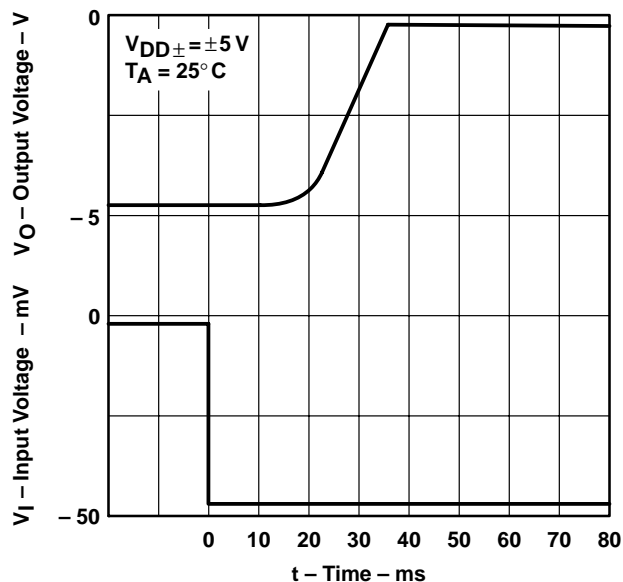

Figure 34. Overload Recovery

APPLICATION INFORMATION

overload recovery/output clamp (continued)

The clamp is a switch that is automatically activated when the output is approximately 1 V from either supply rail. When connected to the inverting input (in parallel with the closed-loop feedback resistor), the closed-loop gain is reduced and the TLC2654 output is prevented from going into saturation. Since the output must source or sink current through the switch (see Figure 9), the maximum output voltage swing is slightly reduced.

thermoelectric effects

To take advantage of the extremely low offset voltage temperature coefficient of the TLC2654, care must be taken to compensate for the thermoelectric effects present when two dissimilar metals are brought into contact with each other (such as device leads being soldered to a printed-circuit board). It is not uncommon for dissimilar metal junctions to produce thermoelectric voltages in the range of several microvolts per degree Celsius (orders of magnitude greater than the $0.01 \mu\text{V}/^\circ\text{C}$ typical of the TLC2654).

To help minimize thermoelectric effects, pay careful attention to component selection and circuit-board layout. Avoid the use of nonsoldered connections (such as sockets, relays, switches, etc.) in the input signal path. Cancel thermoelectric effects by duplicating the number of components and junctions in each device input. The use of low-thermoelectric-coefficient components, such as wire-wound resistors, is also beneficial.

latch-up avoidance

Because CMOS devices are susceptible to latch-up due to their inherent parasitic thyristors, the TLC2654 inputs and outputs are designed to withstand -100-mA surge currents without sustaining latch-up; however, techniques to reduce the chance of latch-up should be used whenever possible. Internal protection diodes should not, by design, be forward biased. Applied input and output voltages should not exceed the supply voltage by more than 300 mV. Care should be exercised when using capacitive coupling on pulse generators. Supply transients should be stunted by the use of decoupling capacitors ($0.1 \mu\text{F}$ typical) located across the supply rails as close to the device as possible.

The current path established if latch-up occurs is usually between the supply rails and is limited only by the impedance of the power supply and the forward resistance of the parasitic thyristor. The chance of latch-up occurring increases with increasing temperature and supply voltage.

electrostatic-discharge protection

The TLC2654 incorporates internal ESD-protection circuits that prevent functional failures at voltages at or below 2000 V. Care should be exercised in handling these devices, as exposure to ESD may result in degradation of the device parametric performance.

theory of operation

Chopper-stabilized operational amplifiers offer the best dc performance of any monolithic operational amplifier. This superior performance is the result of using two operational amplifiers — a main amplifier and a nulling amplifier — plus oscillator-controlled logic and two external capacitors to create a system that behaves as a single amplifier. With this approach, the TLC2654 achieves submicrovolt input offset voltage, submicrovolt noise voltage, and offset voltage variations with temperature in the $\text{nV}/^\circ\text{C}$ range.

The TLC2654 on-chip control logic produces two dominant clock phases: a nulling phase and an amplifying phase. The term chopper-stabilized derives from the process of switching between these two clock phases. Figure 35 shows a simplified block diagram of the TLC2654. Switches A and B are make-before-break types.

TLC2654, TLC2654A
Advanced LinCMOS™ LOW-NOISE CHOPPER-STABILIZED
OPERATIONAL AMPLIFIERS

SLOS020G – NOVEMBER 1988 – REVISED APRIL 2001

APPLICATION INFORMATION

theory of operation (continued)

During the nulling phase, switch A is closed, shorting the nulling amplifier inputs together and allowing the nulling amplifier to reduce its own input offset voltage by feeding its output signal back to an inverting input node. Simultaneously, external capacitor C_{XA} stores the nulling potential to allow the offset voltage of the amplifier to remain nulled during the amplifying phase.

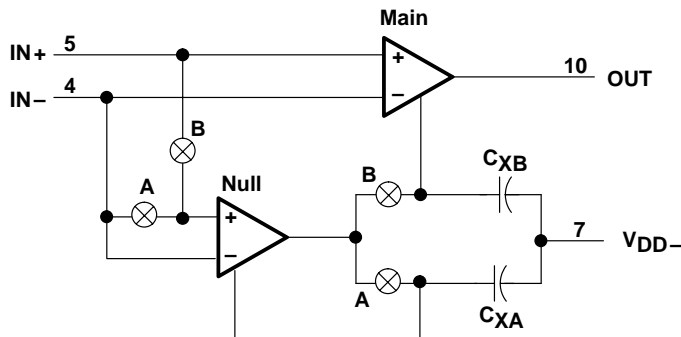

Pin numbers shown are for the D (14 pin), J, and N packages.

Figure 35. TLC2654 Simplified Block Diagram

During the amplifying phase, switch B is closed, connecting the output of the nulling amplifier to a noninverting input of the main amplifier. In this configuration, the input offset voltage of the main amplifier is nulled. Also, external capacitor C_{XB} stores the nulling potential to allow the offset voltage of the main amplifier to remain nulled during the next nulling phase.

This continuous chopping process allows offset voltage nulling during variations in time and temperature and over the common-mode input voltage range and power supply range. In addition, because the low-frequency signal path is through both the null and main amplifiers, extremely high gain is achieved.

The low-frequency noise of a chopper amplifier depends on the magnitude of the component noise prior to chopping and the capability of the circuit to reduce this noise while chopping. The use of the Advanced LinCMOS process, with its low-noise analog MOS transistors and patent-pending input stage design, significantly reduces the input noise voltage.

The primary source of nonideal operation in chopper-stabilized amplifiers is error charge from the switches. As charge imbalance accumulates on critical nodes, input offset voltage can increase especially with increasing chopping frequency. This problem has been significantly reduced in the TLC2654 by use of a patent-pending compensation circuit and the Advanced LinCMOS process.

The TLC2654 incorporates a feed-forward design that ensures continuous frequency response. Essentially, the gain magnitude of the nulling amplifier and compensation network crosses unity at the break frequency of the main amplifier. As a result, the high-frequency response of the system is the same as the frequency response of the main amplifier. This approach also ensures that the slewing characteristics remain the same during both the nulling and amplifying phases.

The primary limitation on ac performance is the chopping frequency. As the input signal frequency approaches the chopper's clock frequency, intermodulation (or aliasing) errors result from the mixing of these frequencies. To avoid these error signals, the input frequency must be less than half the clock frequency. Most choppers available today limit the internal chopping frequency to less than 500 Hz in order to eliminate errors due to the charge imbalancing phenomenon mentioned previously. However, to avoid intermodulation errors on a 500-Hz chopper, the input signal frequency must be limited to less than 250 Hz.

APPLICATION INFORMATION

theory of operation (continued)

The TLC2654 removes this restriction on ac performance by using a 10-kHz internal clock frequency. This high chopping frequency allows amplification of input signals up to 5 kHz without errors due to intermodulation and greatly reduces low-frequency noise.

THERMAL INFORMATION

temperature coefficient of input offset voltage

Figure 36 shows the effects of package-included thermal EMF. The TLC2654 can null only the offset voltage within its nulling loop. There are metal-to-metal junctions outside the nulling loop (bonding wires, solder joints, etc.) that produce EMF. In Figure 36, a TLC2654 packaged in a 14-pin plastic package (N package) was placed in an oven at 25°C at $t = 0$, biased up, and allowed to stabilize. At $t = 3$ min, the oven was turned on and allowed to rise in temperature to 125°C. As evidenced by the curve, the overall change in input offset voltage with temperature is less than the specified maximum limit of 0.05 $\mu\text{V}/^\circ\text{C}$.

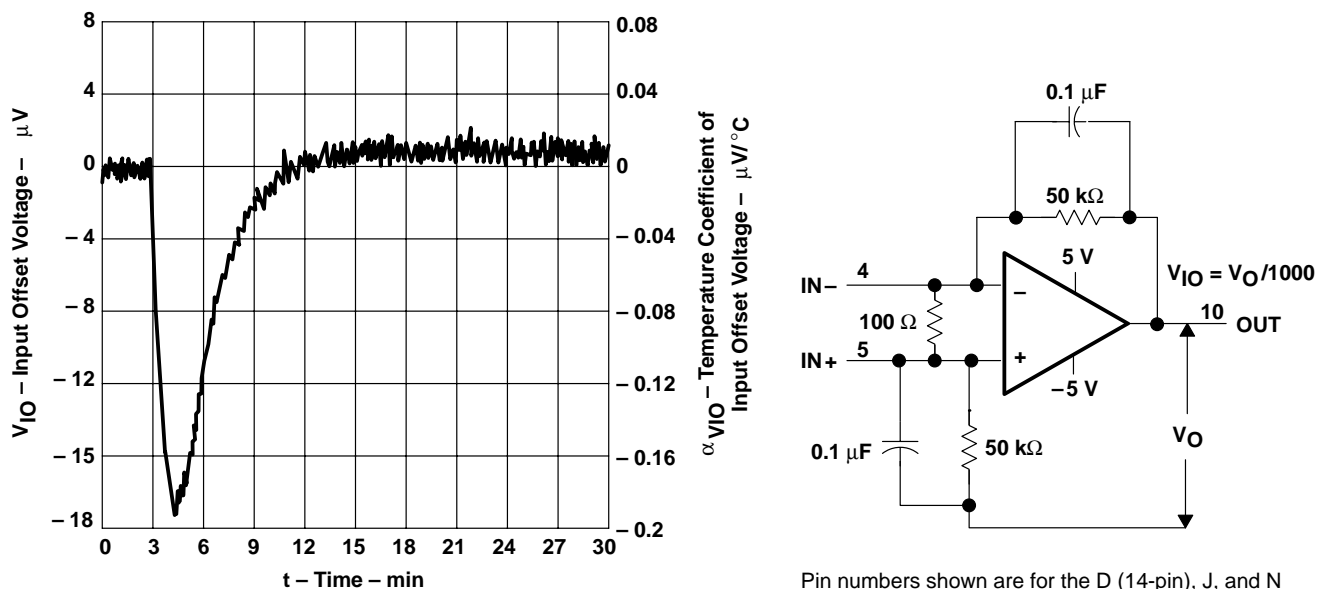

Figure 36. Effects of Package-Induced Thermal EMF

PACKAGING INFORMATION

Orderable Device	Status (1)	Package Type	Package Drawing	Pins	Package Qty	Eco Plan (2)	Lead/Ball Finish (6)	MSL Peak Temp (3)	Op Temp (°C)	Device Marking (4/5)	Samples
5962-9089504QPA	ACTIVE	CDIP	JG	8	1	TBD	A42	N / A for Pkg Type	-55 to 125	9089504QPA TLC2654AM	Samples
TLC2654AC-8D	ACTIVE	SOIC	D	8	75	Green (RoHS & no Sb/Br)	CU NIPDAU	Level-1-260C-UNLIM		2654AC	Samples
TLC2654AC-8DR	OBSOLETE	SOIC	D	8		TBD	Call TI	Call TI			
TLC2654ACP	ACTIVE	PDIP	P	8	50	Pb-Free (RoHS)	CU NIPDAU	N / A for Pkg Type	0 to 70	TLC2654AC	Samples
TLC2654AI-8D	ACTIVE	SOIC	D	8	75	Green (RoHS & no Sb/Br)	CU NIPDAU	Level-1-260C-UNLIM		2654AI	Samples
TLC2654AI-8DG4	ACTIVE	SOIC	D	8	75	Green (RoHS & no Sb/Br)	CU NIPDAU	Level-1-260C-UNLIM		2654AI	Samples
TLC2654AIP	ACTIVE	PDIP	P	8	50	Pb-Free (RoHS)	CU NIPDAU	N / A for Pkg Type		TLC2654AI	Samples
TLC2654AMJGB	ACTIVE	CDIP	JG	8	1	TBD	A42	N / A for Pkg Type	-55 to 125	9089504QPA TLC2654AM	Samples
TLC2654AQ-8D	OBSOLETE	SOIC	D	8		TBD	Call TI	Call TI	-40 to 125		
TLC2654C-14D	OBSOLETE	SOIC	D	14		TBD	Call TI	Call TI			
TLC2654C-14DR	ACTIVE	SOIC	D	14	2500	Green (RoHS & no Sb/Br)	CU NIPDAU	Level-1-260C-UNLIM	0 to 70	TLC2654C	Samples
TLC2654C-8D	ACTIVE	SOIC	D	8	75	Green (RoHS & no Sb/Br)	CU NIPDAU	Level-1-260C-UNLIM		2654C	Samples
TLC2654C-8DG4	ACTIVE	SOIC	D	8	75	Green (RoHS & no Sb/Br)	CU NIPDAU	Level-1-260C-UNLIM		2654C	Samples
TLC2654C-8DR	ACTIVE	SOIC	D	8	2500	Green (RoHS & no Sb/Br)	CU NIPDAU	Level-1-260C-UNLIM		2654C	Samples
TLC2654C-8DRG4	ACTIVE	SOIC	D	8	2500	Green (RoHS & no Sb/Br)	CU NIPDAU	Level-1-260C-UNLIM		2654C	Samples
TLC2654CN	ACTIVE	PDIP	N	14	25	Pb-Free (RoHS)	CU NIPDAU	N / A for Pkg Type	0 to 70	TLC2654CN	Samples
TLC2654CP	ACTIVE	PDIP	P	8	50	Pb-Free (RoHS)	CU NIPDAU	N / A for Pkg Type		TLC2654CP	Samples
TLC2654CPE4	ACTIVE	PDIP	P	8	50	Pb-Free (RoHS)	CU NIPDAU	N / A for Pkg Type		TLC2654CP	Samples

Orderable Device	Status (1)	Package Type	Package Drawing	Pins	Package Qty	Eco Plan (2)	Lead/Ball Finish (6)	MSL Peak Temp (3)	Op Temp (°C)	Device Marking (4/5)	Samples
TLC2654I-8D	ACTIVE	SOIC	D	8	75	Green (RoHS & no Sb/Br)	CU NIPDAU	Level-1-260C-UNLIM		2654I	Samples
TLC2654I-8DR	ACTIVE	SOIC	D	8	2500	Green (RoHS & no Sb/Br)	CU NIPDAU	Level-1-260C-UNLIM	-40 to 85	2654I	Samples
TLC2654IP	ACTIVE	PDIP	P	8	50	Pb-Free (RoHS)	CU NIPDAU	N / A for Pkg Type		TLC2654IP	Samples
TLC2654IPE4	ACTIVE	PDIP	P	8	50	Pb-Free (RoHS)	CU NIPDAU	N / A for Pkg Type	-40 to 85	TLC2654IP	Samples
TLC2654Q-8D	OBSOLETE	SOIC	D	8		TBD	Call TI	Call TI	-40 to 125		

(1) The marketing status values are defined as follows:

ACTIVE: Product device recommended for new designs.

LIFEBUY: TI has announced that the device will be discontinued, and a lifetime-buy period is in effect.

NRND: Not recommended for new designs. Device is in production to support existing customers, but TI does not recommend using this part in a new design.

PREVIEW: Device has been announced but is not in production. Samples may or may not be available.

OBSOLETE: TI has discontinued the production of the device.

(2) Eco Plan - The planned eco-friendly classification: Pb-Free (RoHS), Pb-Free (RoHS Exempt), or Green (RoHS & no Sb/Br) - please check <http://www.ti.com/productcontent> for the latest availability information and additional product content details.

TBD: The Pb-Free/Green conversion plan has not been defined.

Pb-Free (RoHS): TI's terms "Lead-Free" or "Pb-Free" mean semiconductor products that are compatible with the current RoHS requirements for all 6 substances, including the requirement that lead not exceed 0.1% by weight in homogeneous materials. Where designed to be soldered at high temperatures, TI Pb-Free products are suitable for use in specified lead-free processes.

Pb-Free (RoHS Exempt): This component has a RoHS exemption for either 1) lead-based flip-chip solder bumps used between the die and package, or 2) lead-based die adhesive used between the die and leadframe. The component is otherwise considered Pb-Free (RoHS compatible) as defined above.

Green (RoHS & no Sb/Br): TI defines "Green" to mean Pb-Free (RoHS compatible), and free of Bromine (Br) and Antimony (Sb) based flame retardants (Br or Sb do not exceed 0.1% by weight in homogeneous material)

(3) MSL, Peak Temp. - The Moisture Sensitivity Level rating according to the JEDEC industry standard classifications, and peak solder temperature.

(4) There may be additional marking, which relates to the logo, the lot trace code information, or the environmental category on the device.

(5) Multiple Device Markings will be inside parentheses. Only one Device Marking contained in parentheses and separated by a "~" will appear on a device. If a line is indented then it is a continuation of the previous line and the two combined represent the entire Device Marking for that device.

(6) Lead/Ball Finish - Orderable Devices may have multiple material finish options. Finish options are separated by a vertical ruled line. Lead/Ball Finish values may wrap to two lines if the finish value exceeds the maximum column width.

Important Information and Disclaimer: The information provided on this page represents TI's knowledge and belief as of the date that it is provided. TI bases its knowledge and belief on information provided by third parties, and makes no representation or warranty as to the accuracy of such information. Efforts are underway to better integrate information from third parties. TI has taken and continues to take reasonable steps to provide representative and accurate information but may not have conducted destructive testing or chemical analysis on incoming materials and chemicals. TI and TI suppliers consider certain information to be proprietary, and thus CAS numbers and other limited information may not be available for release.

In no event shall TI's liability arising out of such information exceed the total purchase price of the TI part(s) at issue in this document sold by TI to Customer on an annual basis.

OTHER QUALIFIED VERSIONS OF TLC2654A, TLC2654AM :

- Catalog: [TLC2654A](#)
- Military: [TLC2654AM](#)

NOTE: Qualified Version Definitions:

- Catalog - TI's standard catalog product
- Military - QML certified for Military and Defense Applications

TAPE AND REEL INFORMATION

QUADRANT ASSIGNMENTS FOR PIN 1 ORIENTATION IN TAPE

*All dimensions are nominal

Device	Package Type	Package Drawing	Pins	SPQ	Reel Diameter (mm)	Reel Width W1 (mm)	A0 (mm)	B0 (mm)	K0 (mm)	P1 (mm)	W (mm)	Pin1 Quadrant
TLC2654C-14DR	SOIC	D	14	2500	330.0	16.4	6.5	9.0	2.1	8.0	16.0	Q1
TLC2654C-8DR	SOIC	D	8	2500	330.0	12.4	6.4	5.2	2.1	8.0	12.0	Q1
TLC2654I-8DR	SOIC	D	8	2500	330.0	12.4	6.4	5.2	2.1	8.0	12.0	Q1
TLC2654I-8DR	SOIC	D	8	2500	330.0	12.4	6.4	5.2	2.1	8.0	12.0	Q1

TAPE AND REEL BOX DIMENSIONS

*All dimensions are nominal

Device	Package Type	Package Drawing	Pins	SPQ	Length (mm)	Width (mm)	Height (mm)
TLC2654C-14DR	SOIC	D	14	2500	367.0	367.0	38.0
TLC2654C-8DR	SOIC	D	8	2500	340.5	338.1	20.6
TLC2654I-8DR	SOIC	D	8	2500	340.5	338.1	20.6
TLC2654I-8DR	SOIC	D	8	2500	367.0	367.0	38.0

JG (R-GDIP-T8)

CERAMIC DUAL-IN-LINE



- NOTES: A. All linear dimensions are in inches (millimeters).
 B. This drawing is subject to change without notice.
 C. This package can be hermetically sealed with a ceramic lid using glass frit.
 D. Index point is provided on cap for terminal identification.
 E. Falls within MIL STD 1835 GDIP1-T8

P (R-PDIP-T8)

PLASTIC DUAL-IN-LINE PACKAGE



4040082/E 04/2010

- NOTES:
- A. All linear dimensions are in inches (millimeters).
 - B. This drawing is subject to change without notice.
 - C. Falls within JEDEC MS-001 variation BA.

N (R-PDIP-T**)

PLASTIC DUAL-IN-LINE PACKAGE

16 PINS SHOWN



- NOTES:
- A. All linear dimensions are in inches (millimeters).
 - B. This drawing is subject to change without notice.
 - Falls within JEDEC MS-001, except 18 and 20 pin minimum body length (Dim A).
 - The 20 pin end lead shoulder width is a vendor option, either half or full width.

4040049/E 12/2002

D (R-PDSO-G14)

PLASTIC SMALL OUTLINE



- NOTES:
- A. All linear dimensions are in inches (millimeters).
 - B. This drawing is subject to change without notice.
 - Body length does not include mold flash, protrusions, or gate burrs. Mold flash, protrusions, or gate burrs shall not exceed 0.006 (0,15) each side.
 - Body width does not include interlead flash. Interlead flash shall not exceed 0.017 (0,43) each side.
 - E. Reference JEDEC MS-012 variation AB.

D (R-PDSO-G14)

PLASTIC SMALL OUTLINE



4211283-3/E 08/12

- NOTES:
- All linear dimensions are in millimeters.
 - This drawing is subject to change without notice.
 - Publication IPC-7351 is recommended for alternate designs.
 - Laser cutting apertures with trapezoidal walls and also rounding corners will offer better paste release. Customers should contact their board assembly site for stencil design recommendations. Refer to IPC-7525 for other stencil recommendations.
 - Customers should contact their board fabrication site for solder mask tolerances between and around signal pads.

D (R-PDSO-G8)

PLASTIC SMALL OUTLINE



- NOTES:
- A. All linear dimensions are in millimeters.
 - B. This drawing is subject to change without notice.
 - C. Publication IPC-7351 is recommended for alternate designs.
 - D. Laser cutting apertures with trapezoidal walls and also rounding corners will offer better paste release. Customers should contact their board assembly site for stencil design recommendations. Refer to IPC-7525 for other stencil recommendations.
 - E. Customers should contact their board fabrication site for solder mask tolerances between and around signal pads.

IMPORTANT NOTICE

Texas Instruments Incorporated and its subsidiaries (TI) reserve the right to make corrections, enhancements, improvements and other changes to its semiconductor products and services per JESD46, latest issue, and to discontinue any product or service per JESD48, latest issue. Buyers should obtain the latest relevant information before placing orders and should verify that such information is current and complete. All semiconductor products (also referred to herein as "components") are sold subject to TI's terms and conditions of sale supplied at the time of order acknowledgment.

TI warrants performance of its components to the specifications applicable at the time of sale, in accordance with the warranty in TI's terms and conditions of sale of semiconductor products. Testing and other quality control techniques are used to the extent TI deems necessary to support this warranty. Except where mandated by applicable law, testing of all parameters of each component is not necessarily performed.

TI assumes no liability for applications assistance or the design of Buyers' products. Buyers are responsible for their products and applications using TI components. To minimize the risks associated with Buyers' products and applications, Buyers should provide adequate design and operating safeguards.

TI does not warrant or represent that any license, either express or implied, is granted under any patent right, copyright, mask work right, or other intellectual property right relating to any combination, machine, or process in which TI components or services are used. Information published by TI regarding third-party products or services does not constitute a license to use such products or services or a warranty or endorsement thereof. Use of such information may require a license from a third party under the patents or other intellectual property of the third party, or a license from TI under the patents or other intellectual property of TI.

Reproduction of significant portions of TI information in TI data books or data sheets is permissible only if reproduction is without alteration and is accompanied by all associated warranties, conditions, limitations, and notices. TI is not responsible or liable for such altered documentation. Information of third parties may be subject to additional restrictions.

Resale of TI components or services with statements different from or beyond the parameters stated by TI for that component or service voids all express and any implied warranties for the associated TI component or service and is an unfair and deceptive business practice. TI is not responsible or liable for any such statements.

Buyer acknowledges and agrees that it is solely responsible for compliance with all legal, regulatory and safety-related requirements concerning its products, and any use of TI components in its applications, notwithstanding any applications-related information or support that may be provided by TI. Buyer represents and agrees that it has all the necessary expertise to create and implement safeguards which anticipate dangerous consequences of failures, monitor failures and their consequences, lessen the likelihood of failures that might cause harm and take appropriate remedial actions. Buyer will fully indemnify TI and its representatives against any damages arising out of the use of any TI components in safety-critical applications.

In some cases, TI components may be promoted specifically to facilitate safety-related applications. With such components, TI's goal is to help enable customers to design and create their own end-product solutions that meet applicable functional safety standards and requirements. Nonetheless, such components are subject to these terms.

No TI components are authorized for use in FDA Class III (or similar life-critical medical equipment) unless authorized officers of the parties have executed a special agreement specifically governing such use.

Only those TI components which TI has specifically designated as military grade or "enhanced plastic" are designed and intended for use in military/aerospace applications or environments. Buyer acknowledges and agrees that any military or aerospace use of TI components which have **not** been so designated is solely at the Buyer's risk, and that Buyer is solely responsible for compliance with all legal and regulatory requirements in connection with such use.

TI has specifically designated certain components as meeting ISO/TS16949 requirements, mainly for automotive use. In any case of use of non-designated products, TI will not be responsible for any failure to meet ISO/TS16949.

Products

Audio	www.ti.com/audio
Amplifiers	amplifier.ti.com
Data Converters	dataconverter.ti.com
DLP® Products	www.dlp.com
DSP	dsp.ti.com
Clocks and Timers	www.ti.com/clocks
Interface	interface.ti.com
Logic	logic.ti.com
Power Mgmt	power.ti.com
Microcontrollers	microcontroller.ti.com
RFID	www.ti-rfid.com
OMAP Applications Processors	www.ti.com/omap
Wireless Connectivity	www.ti.com/wirelessconnectivity

Applications

Automotive and Transportation	www.ti.com/automotive
Communications and Telecom	www.ti.com/communications
Computers and Peripherals	www.ti.com/computers
Consumer Electronics	www.ti.com/consumer-apps
Energy and Lighting	www.ti.com/energy
Industrial	www.ti.com/industrial
Medical	www.ti.com/medical
Security	www.ti.com/security
Space, Avionics and Defense	www.ti.com/space-avionics-defense
Video and Imaging	www.ti.com/video

TI E2E Community

e2e.ti.com