

TITLE
 INDUCTOR, 470 μ H,
 1.9 ADC, BUCK

SCHOTT
 CORPORATION 1000 PARKERS LAKE ROAD
 WAYZATA, MN 55391

AGENCY APPROVAL:
 N/A

PART NUMBER
34048
 REV A PAGE 1 END

CATALOG NUMBER:
 67127090

SPECIFICATIONS

1. TEMP CLASS 130°C.
2. INDUCTANCE (1,2,3-4,5,6): 430 - 520 μ H
 @ 0.1 Vrms, 10 KHz.
3. DC RESISTANCE (1,2,3-4,5,6): 0.060 OHM MAX.
4. HIPOT: 250 VDC.
 (2 SECONDS, 5 mA MAX)

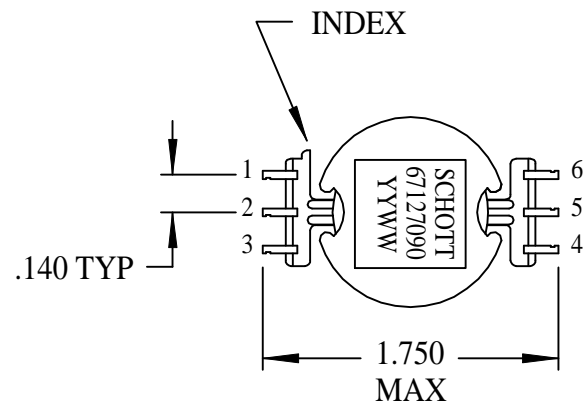

THIS INDUCTOR IS FOR USE WITH
 NATIONAL SEMICONDUCTOR REGULATORS
 LM1575-XX/LM2575-XX
 LK1577-XX/LM2577-XX

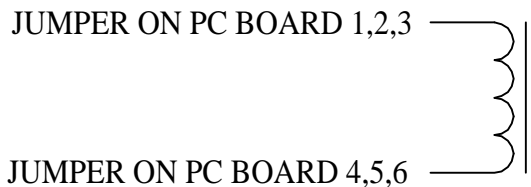
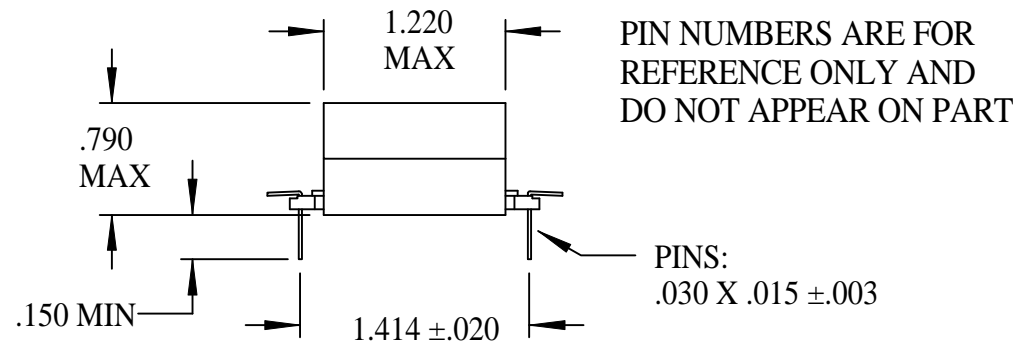

TOLERANCES UNLESS OTHERWISE NOTED	2 PLACE	3 PLACE	ANGLE
	+ -	+ -	+ °