

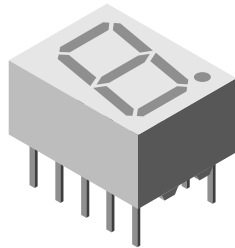

Standard 7-Segment Display 10 mm



19236

DESCRIPTION

The TDS.31.. series are 10 mm character seven segment LED displays in a very compact package.

The displays are designed for a viewing distance up to 6 m and available in four bright colors. The grey package surface and the evenly lighted untinted segments provide an optimum on-off contrast.

All displays are categorized in luminous intensity groups. That allows users to assemble displays with uniform appearance. Typical applications include instruments, panel meters, point-of-sale terminals and household equipment.

FEATURES

- Evenly lighted segments
- Grey package surface
- Untinted segments
- Luminous intensity categorized
- Yellow and green categorized for color
- Wide viewing angle
- Suitable for DC and high peak current
- Material categorization: For definitions of compliance please see www.vishay.com/doc?99912



RoHS
COMPLIANT

APPLICATIONS

- Panel meters
- Test- and measure-equipment
- Point-of-sale terminals
- Control units

PRODUCT GROUP AND PACKAGE DATA

- Product group: Display
- Package: 10 mm
- Product series: Standard
- Angle of half intensity: $\pm 50^\circ$

PARTS TABLE														
PART	COLOR	LUMINOUS INTENSITY (μcd)			at I_F (mA)	WAVELENGTH (nm)			at I_F (mA)	FORWARD VOLTAGE (V)			at I_F (mA)	CIRCUITRY
		MIN.	TYP.	MAX.		MIN.	TYP.	MAX.		MIN.	TYP.	MAX.		
TDSO3150	Orange red	450	4500	-	10	612	-	625	10	-	2	3	20	Common anode
TDSO3150-KL	Orange red	1800	-	5600	10	612	-	625	10	-	2	3	20	Common anode
TDSO3150-L	Orange red	2800	-	5600	10	612	-	625	10	-	2	3	20	Common anode
TDSO3155	Orange red	1100	-	9000	10	612	-	625	10	-	2	3	20	Common anode
TDSO3160	Orange red	450	4500	-	10	612	-	625	10	-	2	3	20	Common cathode
TDSO3160-KL	Orange red	1800	-	5600	10	612	-	625	10	-	2	3	20	Common cathode
TDSO3160-L	Orange red	2800	-	5600	10	612	-	625	10	-	2	3	20	Common cathode
TDSY3150	Yellow	450	3000	-	10	581	-	594	10	-	2.4	3	20	Common anode
TDSY3150-K	Yellow	1800	-	3600	10	581	-	594	10	-	2.4	3	20	Common anode
TDSY3160	Yellow	450	3000	-	10	581	-	594	10	-	2.4	3	20	Common cathode
TDSG3150	Green	450	6800	-	10	562	-	575	10	-	2.4	3	20	Common anode
TDSG3150-M	Green	4500	-	9000	10	562	-	575	10	-	2.4	3	20	Common anode
TDSG3150-MN	Green	4500	-	14 000	10	562	-	575	10	-	2.4	3	20	Common anode
TDSG3151	Green	1800	-	9000	10	562	-	575	10	-	2.4	3	20	Common anode
TDSG3160	Green	450	6800	-	10	562	-	575	10	-	2.4	3	20	Common cathode
TDSG3160-M	Green	4500	-	9000	10	562	-	575	10	-	2.4	3	20	Common cathode



ABSOLUTE MAXIMUM RATINGS ($T_{amb} = 25\text{ }^{\circ}\text{C}$, unless otherwise specified) TDSO315., TDSO316., TDSY315., TDSY316., TDSG315., TDSG316.				
PARAMETER	TEST CONDITION	SYMBOL	VALUE	UNIT
Reverse voltage per segment or DP		V_R	6	V
DC forward current per segment or DP		I_F	20	mA
DC forward current per segment or DP	$t_p \leq 10\text{ }\mu\text{s}$ (non repetitive)	I_{FSM}	0.15	A
Power dissipation	$T_{amb} \leq 45\text{ }^{\circ}\text{C}$	P_V	480	mW
Junction temperature		T_j	100	$^{\circ}\text{C}$
Operating temperature range		T_{amb}	-40 to +85	$^{\circ}\text{C}$
Storage temperature range		T_{stg}	-40 to +85	$^{\circ}\text{C}$
Soldering temperature	$t \leq 3\text{ s}$, 2 mm below seating plane	T_{sd}	260	$^{\circ}\text{C}$
Thermal resistance LED junction/ambient		R_{thJA}	120	K/W

OPTICAL AND ELECTRICAL CHARACTERISTICS ($T_{amb} = 25\text{ }^{\circ}\text{C}$, unless otherwise specified) TDSO3150, TDSO3150-KL, TDSO3150-L, TDSO3155, TDSO3160, TDSO3160-KL, TDSO3160-L, ORANGE RED							
PARAMETER	TEST CONDITION	PART	SYMBOL	MIN.	TYP.	MAX.	UNIT
Luminous intensity per segment (digit average) ⁽¹⁾	$I_F = 10\text{ mA}$	TDSO3150	I_V	450	4500	-	μcd
		TDSO3150-KL		1800	-	5600	
		TDSO3150-L		2800	-	5600	
		TDSO3155		1100	-	9000	
		TDSO3160		450	4500	-	
		TDSO3160-KL		1800	-	5600	
		TDSO3160-L		2800	-	5600	
Dominant wavelength	$I_F = 10\text{ mA}$	TDSO3150, TDSO3150-KL, TDSO3150-L,	λ_d	612	-	625	nm
Peak wavelength	$I_F = 10\text{ mA}$	TDSO3150-KL, TDSO3150-L,	λ_p	-	630	-	nm
Angle of half intensity	$I_F = 10\text{ mA}$	TDSO3155, TDSO3160, TDSO3160-KL, TDSO3160-L	j	-	± 50	-	deg
Forward voltage per segment or DP	$I_F = 20\text{ mA}$		V_F	-	2	3	V
Reverse voltage per segment or DP	$I_R = 10\text{ }\mu\text{A}$		V_R	6	15	-	V

Note

⁽¹⁾ $I_{Vmin.}$ and I_V groups are mean values of all segments (a to g, D1 to D4), matching factor within segments is ≥ 0.5 , excluding decimal points and colon.

OPTICAL AND ELECTRICAL CHARACTERISTICS ($T_{amb} = 25\text{ }^{\circ}\text{C}$, unless otherwise specified) TDSY3150, TDSY3150-K, TDSY3160, YELLOW							
PARAMETER	TEST CONDITION	PART	SYMBOL	MIN.	TYP.	MAX.	UNIT
Luminous intensity per segment (digit average) ⁽¹⁾	$I_F = 10\text{ mA}$	TDSY3150	I_V	450	3000	-	μcd
		TDSY3150-K		1800	-	3600	
		TDSY3160		450	3000	-	
Dominant wavelength	$I_F = 10\text{ mA}$	TDSY3150, TDSY3150-K, TDSY3160	λ_d	581	-	594	nm
Peak wavelength	$I_F = 10\text{ mA}$		λ_p	-	585	-	nm
Angle of half intensity	$I_F = 10\text{ mA}$		j	-	± 50	-	deg
Forward voltage per segment or DP	$I_F = 20\text{ mA}$		V_F	-	2.4	3	V
Reverse voltage per segment or DP	$I_R = 10\text{ }\mu\text{A}$		V_R	6	15	-	V

Note

⁽¹⁾ $I_{Vmin.}$ and I_V groups are mean values of all segments (a to g, D1 to D4), matching factor within segments is ≥ 0.5 , excluding decimal points and colon.



OPTICAL AND ELECTRICAL CHARACTERISTICS (T _{amb} = 25 °C, unless otherwise specified)							
TDSG315., TDSG316., GREEN							
PARAMETER	TEST CONDITION	PART	SYMBOL	MIN.	TYP.	MAX.	UNIT
Luminous intensity per segment (digit average) ⁽¹⁾	I _F = 10 mA	TDSG3150	I _V	450	6800	-	μcd
		TDSG3150-M		4500	-	9000	
		TDSG3150-MN		4500	-	14 000	
		TDSG3151		1800	-	9000	
		TDSG3160		450	6800	-	
		TDSG3160-M		4500	-	9000	
Dominant wavelength	I _F = 10 mA	TDSG3150, TDSG3150-M, TDSG3150-MN, TDSG3151, TDSG3160, TDSG3160-M	λ _d	562	-	575	nm
Peak wavelength	I _F = 10 mA		λ _p	-	565	-	nm
Angle of half intensity	I _F = 10 mA		j	-	± 50	-	deg
Forward voltage per segment or DP	I _F = 20 mA		V _F	-	2.4	3	V
Reverse voltage per segment or DP	I _R = 10 μA		V _R	6	15	-	V

Note

⁽¹⁾ I_{Vmin.} and I_V groups are mean values of all segments (a to g, D1 to D4), matching factor within segments is ≥ 0.5, excluding decimal points and colon.

LUMINOUS INTENSITY CLASSIFICATION		
GROUP	LIGHT INTENSITY (μcd)	
	MIN.	MAX.
STANDARD		
E	180	360
F	280	560
G	450	900
H	700	1400
I	1100	2200
K	1800	3600
L	2800	5600
M	4500	9000
N	7000	14 000

Note

- The above type numbers represent the order groups which include only a few brightness groups. Only one group will be shipped in one tube (there will be no mixing of two groups in one tube). In order to ensure availability, single brightness groups will not be orderable.

COLOR CLASSIFICATION						
GROUP	ORANGE RED		YELLOW		GREEN	
	MIN.	MAX.	MIN.	MAX.	MIN.	MAX.
1	612	617	581	584		
2	616	621	583	586		
3	620	625	585	588	562	565
4			587	590	564	567
5			589	592	566	569
6			591	594	568	571
7					570	573
8					572	575

Note

- Wavelengths are tested at a current pulse duration of 25 ms and an accuracy of ± 1 nm.



TYPICAL CHARACTERISTICS (T_{amb} = 25 °C, unless otherwise specified)

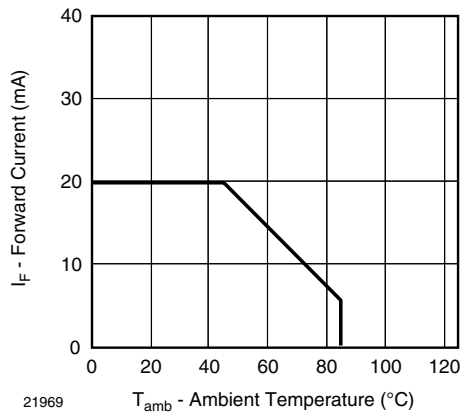

Fig. 1 - Forward Current vs. Ambient Temperature



Fig. 4 - Relative Luminous Intensity vs. Ambient Temperature

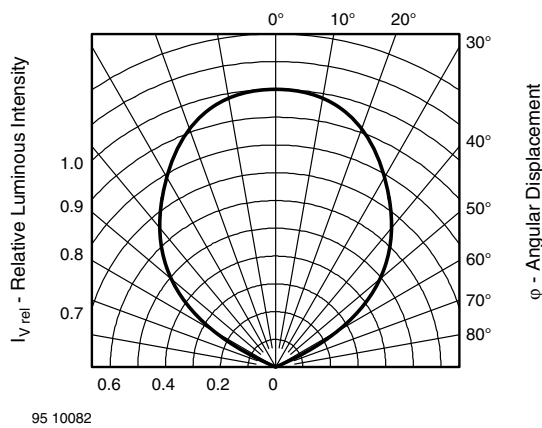

Fig. 2 - Relative Luminous Intensity vs. Angular Displacement

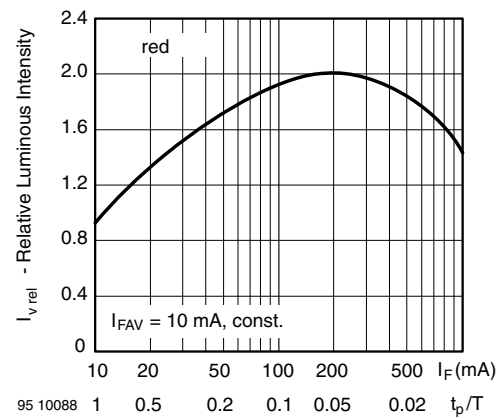

Fig. 5 - Relative Luminous Intensity vs. Forward Current/Duty Cycle

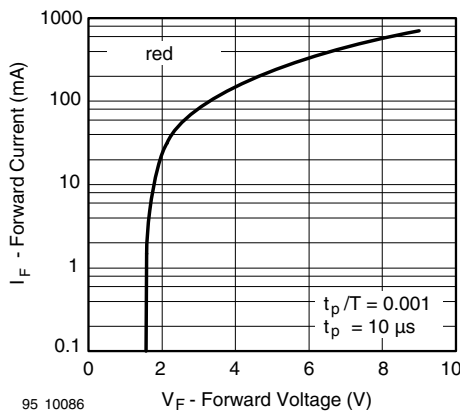

Fig. 3 - Forward Current vs. Forward Voltage



Fig. 6 - Relative Luminous Intensity vs. Forward Current

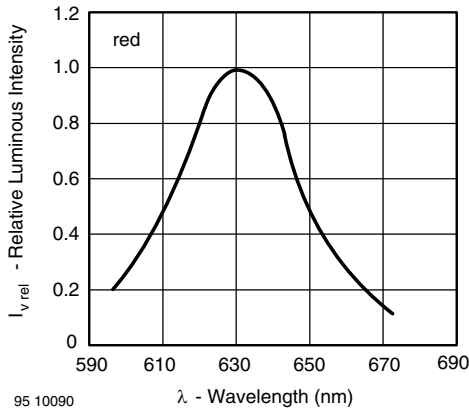

Fig. 7 - Relative Intensity vs. Wavelength

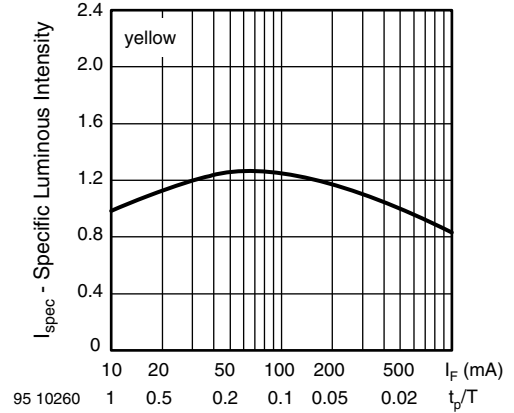

Fig. 10 - Relative Luminous Intensity vs. Forward Current/Duty Cycle

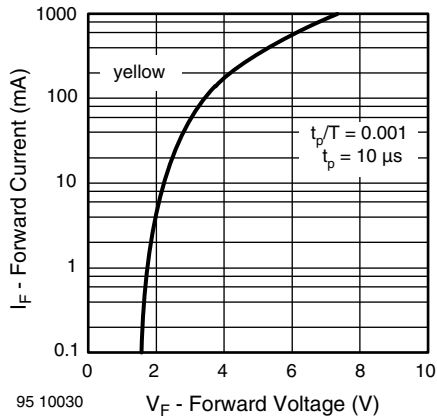

Fig. 8 - Forward Current vs. Forward Voltage

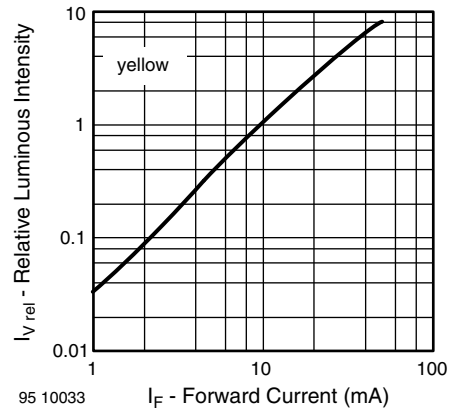

Fig. 11 - Relative Luminous Intensity vs. Forward Current

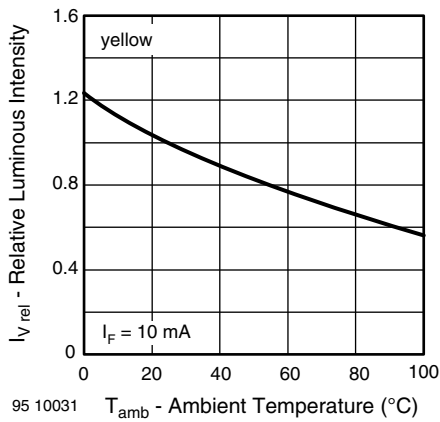

Fig. 9 - Relative Luminous Intensity vs. Ambient Temperature

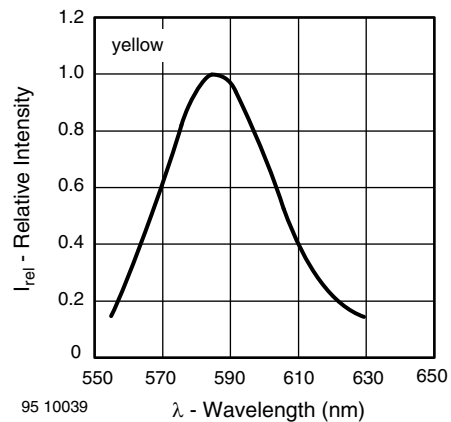

Fig. 12 - Relative Intensity vs. Wavelength

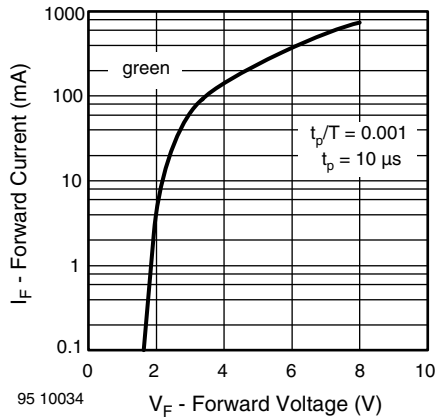

Fig. 13 - Forward Current vs. Forward Voltage



Fig. 16 - Relative Luminous Intensity vs. Forward Current

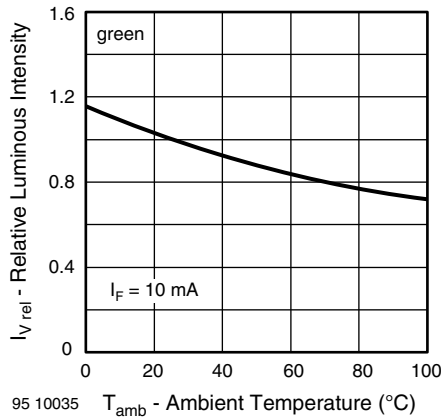

Fig. 14 - Relative Luminous Intensity vs. Ambient Temperature

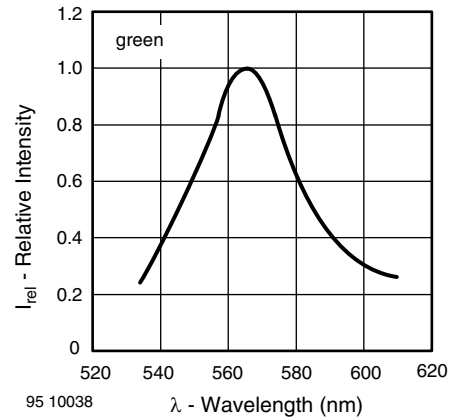

Fig. 17 - Relative Intensity vs. Wavelength

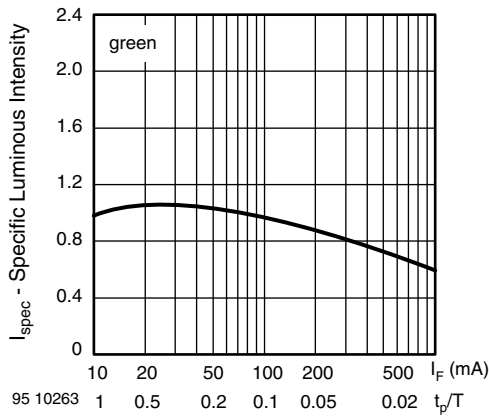

Fig. 15 - Specific Luminous Intensity vs. Forward Current

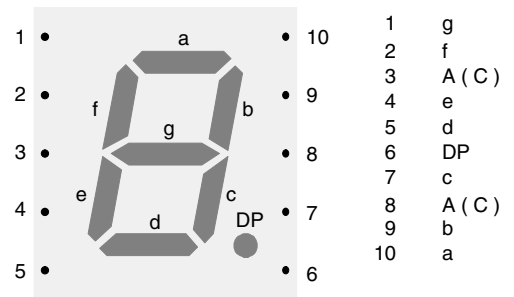
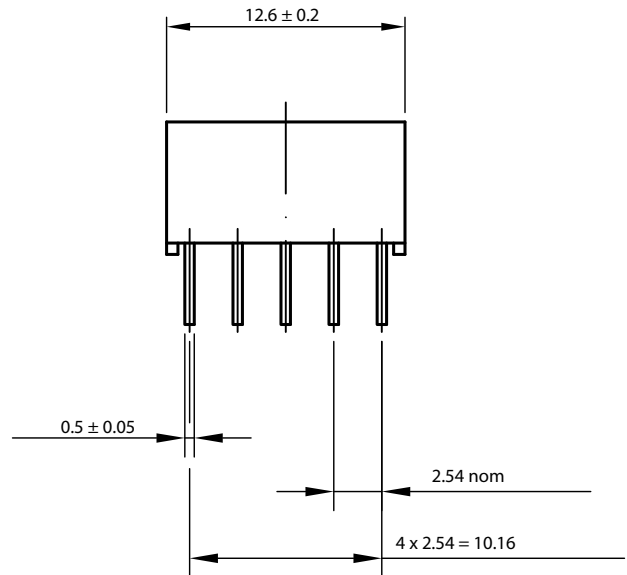

Fig. 18 - TDS.31..

96 11678



PACKAGE DIMENSIONS FOR TDS.31.. in millimeters



technical drawings
according to DIN
specifications

Drawing-No.: 6.544-5093.01-4
Issue: 2; 23.03.2012



Pin Connections 10 mm



9611678

Ozone Depleting Substances Policy Statement

It is the policy of **Vishay Semiconductor GmbH** to

1. Meet all present and future national and international statutory requirements.
2. Regularly and continuously improve the performance of our products, processes, distribution and operating systems with respect to their impact on the health and safety of our employees and the public, as well as their impact on the environment.

It is particular concern to control or eliminate releases of those substances into the atmosphere which are known as ozone depleting substances (ODSs).

The Montreal Protocol (1987) and its London Amendments (1990) intend to severely restrict the use of ODSs and forbid their use within the next ten years. Various national and international initiatives are pressing for an earlier ban on these substances.

Vishay Semiconductor GmbH has been able to use its policy of continuous improvements to eliminate the use of ODSs listed in the following documents.

1. Annex A, B and list of transitional substances of the Montreal Protocol and the London Amendments respectively
2. Class I and II ozone depleting substances in the Clean Air Act Amendments of 1990 by the Environmental Protection Agency (EPA) in the USA
3. Council Decision 88/540/EEC and 91/690/EEC Annex A, B and C (transitional substances) respectively.

Vishay Semiconductor GmbH can certify that our semiconductors are not manufactured with ozone depleting substances and do not contain such substances.

**We reserve the right to make changes to improve technical design
and may do so without further notice.**

Parameters can vary in different applications. All operating parameters must be validated for each customer application by the customer. Should the buyer use Vishay Semiconductors products for any unintended or unauthorized application, the buyer shall indemnify Vishay Semiconductors against all claims, costs, damages, and expenses, arising out of, directly or indirectly, any claim of personal damage, injury or death associated with such unintended or unauthorized use.

Vishay Semiconductor GmbH, P.O.B. 3535, D-74025 Heilbronn, Germany
Telephone: 49 (0)7131 67 2831, Fax number: 49 (0)7131 67 2423



Disclaimer

ALL PRODUCT, PRODUCT SPECIFICATIONS AND DATA ARE SUBJECT TO CHANGE WITHOUT NOTICE TO IMPROVE RELIABILITY, FUNCTION OR DESIGN OR OTHERWISE.

Vishay Intertechnology, Inc., its affiliates, agents, and employees, and all persons acting on its or their behalf (collectively, "Vishay"), disclaim any and all liability for any errors, inaccuracies or incompleteness contained in any datasheet or in any other disclosure relating to any product.

Vishay makes no warranty, representation or guarantee regarding the suitability of the products for any particular purpose or the continuing production of any product. To the maximum extent permitted by applicable law, Vishay disclaims (i) any and all liability arising out of the application or use of any product, (ii) any and all liability, including without limitation special, consequential or incidental damages, and (iii) any and all implied warranties, including warranties of fitness for particular purpose, non-infringement and merchantability.

Statements regarding the suitability of products for certain types of applications are based on Vishay's knowledge of typical requirements that are often placed on Vishay products in generic applications. Such statements are not binding statements about the suitability of products for a particular application. It is the customer's responsibility to validate that a particular product with the properties described in the product specification is suitable for use in a particular application. Parameters provided in datasheets and / or specifications may vary in different applications and performance may vary over time. All operating parameters, including typical parameters, must be validated for each customer application by the customer's technical experts. Product specifications do not expand or otherwise modify Vishay's terms and conditions of purchase, including but not limited to the warranty expressed therein.

Except as expressly indicated in writing, Vishay products are not designed for use in medical, life-saving, or life-sustaining applications or for any other application in which the failure of the Vishay product could result in personal injury or death. Customers using or selling Vishay products not expressly indicated for use in such applications do so at their own risk. Please contact authorized Vishay personnel to obtain written terms and conditions regarding products designed for such applications.

No license, express or implied, by estoppel or otherwise, to any intellectual property rights is granted by this document or by any conduct of Vishay. Product names and markings noted herein may be trademarks of their respective owners.