

# CompactFlash™ BUS-INTERFACE CHIP

## WITH ±15-kV ESD PROTECTION, TRANSLATION, AND CARD-DETECT CIRCUITRY

Check for Samples: [CF4320H](#)

### FEATURES

- **±15-kV Human-Body Model (HBM) ESD Protection on Card Side**
- **Logic-Level Translation Between 1.8-V, 2.5-V, 3.3-V, and 5-V Supplies**
- **Integrated Card-Detect Circuitry**
- **Integrated Pullup/Pulldown Resistors Save Board Space and Cost**
- **Matched Pinout With CompactFlash™ (CF) Connector Pin Configurations to Optimize PCB Layout**
- **Input-Disable Feature Allows Floating Input Conditions**
- **I<sub>off</sub> Supports Partial-Power-Down Mode Operation**
- **Offered in 114-Ball LFBGA Package for Space-Constrained Applications**
- **Latch-Up Performance Exceeds 250 mA Per JESD 17**
- **ESD Performance**
  - ±15-kV HBM
  - ±4-kV IEC61000-4-2, Contact Discharge (Latch-Up Immune)

### TARGET APPLICATIONS

- **GPS PDAs**
- **PDA Phones**
- **Industrial PDAs**
- **High-End Digital Cameras**

### DESCRIPTION

The CF4320H is a CompactFlash™ (CF) interface device designed to provide a single-chip solution for CF card interfaces. Separate V<sub>CC</sub> rails for the system-bus side and the CF connector-bus side allow voltage-level shifting. This is helpful for interfacing between a core chipset that may operate from 3.3 V down to 1.65 V, and CF cards that operate from 3.3-V or 5-V supply voltages. All the input buffers feature the input-disable function, which allows conditional floating input signals. The input, output, and I/O buffers on the CF connector side have been defined to comply with CF+ and CF specification revisions 1.4 and 2.0.

### TYPICAL APPLICATION

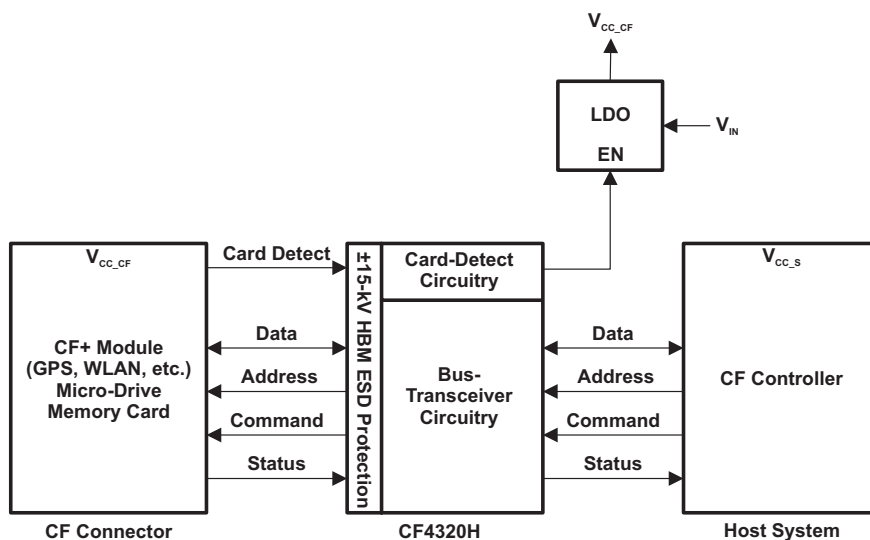

Please be aware that an important notice concerning availability, standard warranty, and use in critical applications of Texas Instruments semiconductor products and disclaimers thereto appears at the end of this data sheet.

CompactFlash is a trademark of Sandisk Corporation.

## CARD-DETECT CIRCUIT

The CF4320H has an integrated card-detect circuit that generates a LOW card-detect signal when a CF card is plugged into the socket. This circuit is supplied by a separate power-supply pin,  $V_{CC\_SD}$ , which operates from 1.65 V to 5.5 V. The card-detect signal can be used to control a voltage regulator, which may power the CF slot and the CF side of the CF4320H. The inputs to this circuitry ( $\overline{CD1}$  and  $\overline{CD2}$ ) have internal pullup resistors to pull them to a HIGH logic state if there is no card in the CF slot.  $V_{CC\_SD}$  is particularly helpful when the core processor operates at a low  $V_{CC}$ , but the regulator needs a higher control-signal voltage.

**Table 1. CARD-DETECT SIGNALS**

INPUTS		OUTPUT $\overline{SCD}$
$\overline{CD1}$	$\overline{CD2}$	
L	L	L
L	H	H
H	L	H
H	H	H

## BUS-TRANSCEIVER CIRCUIT

### Command and Status Bits

Most CF controllers are embedded in processors or microcontrollers and use GPIOs to send command signals and receive status signals from the card to manage operation. The CF interface consists of eight control signals and six status signals. The CF standard requires that each of these signals have a 100-k $\Omega$  pullup resistor. The CF4320H includes an internal 100-k $\Omega$  pullup resistor on the input of each of these signals, which saves board real estate and lowers overall system cost.

**COMMAND LINE BUFFERS<sup>(1)</sup>**  
( $\overline{BVD1}$ ,  $\overline{BVD2}$ ,  $\overline{INPACK}$ ,  $\overline{OE}$ ,  $\overline{IORD}$ ,  $\overline{IOWR}$ ,  
 $\overline{READY}$ ,  $\overline{REG}$ ,  $\overline{CE1}$ ,  $\overline{CE2}$ ,  $\overline{WAIT}$ ,  $\overline{WE}$ ,  $\overline{WP}$ )

INPUTS			OUTPUT
$\overline{MASTER\_EN}$	$\overline{BUF\_EN}$	INPUT	
L	L	H	H
L	L	L	L
L	H	X	Z, Command line buffer inputs can float.
H	X	X	Z, low-power mode

(1) X = H or L

**RESET<sup>(1)</sup>**

INPUTS		OUTPUT RESET
$\overline{MASTER\_EN}$	$\overline{SRESET}$	
L	H	H
L	L	L
H	X	Z, low-power mode

(1) X = H or L

### Data Bits

The CF4320H has 16 data lines organized as two groups of 8 bits each. The  $\overline{ENL}$  signal controls the lower 8 bits (D07–D00), while the  $\overline{ENH}$  signal controls the upper 8 bits (D15–D08).

**LOWER 8-BIT DATA BUS TRANSCEIVERS<sup>(1)</sup>  
(D07–D00, SD07–SD00)**

INPUTS			OPERATION
MASTER_EN	ENL	DIR ( $\bar{S}/CF$ )	
L	L	H	SD data to D bus
L	L	L	D data to SD bus
L	H	X	Isolation. D07–D00 and SD07–SD00 inputs can float.
H	X	X	Isolation, low-power mode

(1) X = H or L

**UPPER 8-BIT DATA BUS TRANSCEIVERS<sup>(1)</sup>  
(D15–D08, SD15–SD08)**

INPUTS			OPERATION
MASTER_EN	ENH	DIR ( $\bar{S}/CF$ )	
L	L	H	SD data to D bus
L	L	L	D data to SD bus
L	H	X	Isolation. D15–D08 and SD15–SD08 inputs can float.
H	X	X	Isolation, low-power mode

(1) X = H or L

**Address Bits**

The CF4320H has 11 unidirectional address bits flowing from the system to the CF card.

**ADDRESS BUS BUFFERS<sup>(1)</sup>**

INPUTS			OUTPUT A
MASTER_EN	BUF_EN	SA	
L	L	H	H
L	L	L	L
L	H	X	Z, SA inputs can float.
H	X	X	Z, low-power mode

(1) X = H or L

### Direction Signal Bit

The DIR( $\overline{S}/CF$ ) input controls the data direction between the system bus and the CF card. The CF4320H has circuitry to generate a DIR\_OUT signal using the  $\overline{SOE}$  and  $\overline{SIORD}$  signals. DIR( $\overline{S}/CF$ ) and DIR\_OUT are placed adjacent to each other, which is convenient for connecting DIR( $\overline{S}/CF$ ) and DIR\_OUT, if DIR\_OUT is used. This saves an additional signal from the system controller to control the data direction. When either  $\overline{SOE}$  or  $\overline{SIORD}$  is low, the data direction is from the CF card side to the system side (DIR\_OUT = L).

INPUTS				OUTPUT DIR_OUT
$\overline{BUF\_EN}$	$\overline{MASTER\_EN}$	$\overline{SOE}$	$\overline{SIORD}$	
L	L	L	L	L
L	L	L	H	L
L	L	H	L	L
L	L	H	H	H
H	L	X	X	L
X	H	X	X	Z, low-power mode

(1) X = H or L

## BOARD-OPTIMIZED PIN CONFIGURATION

GKF OR ZKF PACKAGE  
(TOP VIEW)

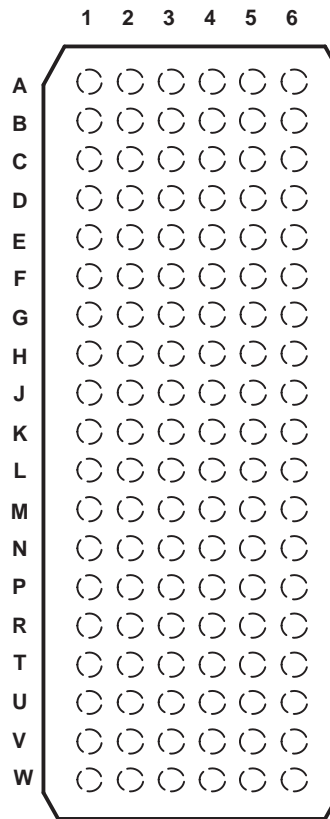

### TERMINAL ASSIGNMENTS

	1	2	3	4	5	6
<b>A</b>	D12	D04	D03	SD14	SD12	SD11
<b>B</b>	D13	D05	D11	SD13	SD10	SD09
<b>C</b>	D14	D06	SD15	$\overline{\text{SINPACK}}$	SD08	SD07
<b>D</b>	D15	D07	$V_{CC\_CF}$	$V_{CC\_S}$	SD06	SD05
<b>E</b>	$\overline{\text{CE2}}$	$\overline{\text{CE1}}$	GND	GND	SD04	SD03
<b>F</b>	$\overline{\text{OE}}$	A10	$V_{CC\_CF}$	$V_{CC\_S}$	SD02	SD01
<b>G</b>	A09	$\overline{\text{IORD}}$	GND	GND	SD00	$\overline{\text{SCE1}}$
<b>H</b>	A08	$\overline{\text{IOWR}}$	$V_{CC\_CF}$	$V_{CC\_S}$	$\overline{\text{ENL}}$	$\overline{\text{ENH}}$
<b>J</b>	A07	$\overline{\text{WE}}$	GND	GND	$\overline{\text{MASTER\_EN}}$	$\overline{\text{BUF\_EN}}$
<b>K</b>	A06	READY	A05	$\overline{\text{SCE2}}$	$\overline{\text{SOE}}$	$\overline{\text{SIORD}}$
<b>L</b>	A04	RESET	GND	GND	$\overline{\text{SWE}}$	$\overline{\text{SIOWR}}$
<b>M</b>	A03	$\overline{\text{WAIT}}$	$V_{CC\_CF}$	$V_{CC\_S}$	SREADY	SRESET
<b>N</b>	A02	$\overline{\text{INPACK}}$	GND	GND	$\overline{\text{SWAIT}}$	$\overline{\text{SREG}}$
<b>P</b>	A01	$\overline{\text{REG}}$	$V_{CC\_CF}$	GND	SBVD2	SBVD1
<b>R</b>	A00	BVD2	$V_{CC\_CF}$	$V_{CC\_S}$	SA10	SWP
<b>T</b>	D00	BVD1	$V_{CC\_SD}$	DIR( $\overline{\text{S}}$ /CF)	SA08	SA09
<b>U</b>	D01	D08	$\overline{\text{CD1}}$	DIR_OUT	SA06	SA07
<b>V</b>	D02	D09	$\overline{\text{CD2}}$	SA00	SA04	SA05
<b>W</b>	WP	D10	$\overline{\text{SCD}}$	SA01	SA02	SA03

### TERMINAL FUNCTIONS

TERMINAL		DESCRIPTION	REFERENCED TO	I/O <sup>(1)</sup>
NO.	NAME			
A1	D12	Data bit 12 connected to card	V <sub>CC_CF</sub>	I/O
B1	D13	Data bit 13 connected to card	V <sub>CC_CF</sub>	I/O
C1	D14	Data bit 14 connected to card	V <sub>CC_CF</sub>	I/O
D1	D15	Data bit 15 connected to card	V <sub>CC_CF</sub>	I/O
E1	$\overline{\text{CE2}}$	Card enable connected to card	V <sub>CC_CF</sub>	O
F1	$\overline{\text{OE}}$	Output enable connected to card	V <sub>CC_CF</sub>	O
G1	A09	Address bit 9 connected to card	V <sub>CC_CF</sub>	O
H1	A08	Address bit 8 connected to card	V <sub>CC_CF</sub>	O
J1	A07	Address bit 7 connected to card	V <sub>CC_CF</sub>	O
K1	A06	Address bit 6 connected to card	V <sub>CC_CF</sub>	O
L1	A04	Address bit 4 connected to card	V <sub>CC_CF</sub>	O
M1	A03	Address bit 3 connected to card	V <sub>CC_CF</sub>	O
N1	A02	Address bit 2 connected to card	V <sub>CC_CF</sub>	O
P1	A01	Address bit 1 connected to card	V <sub>CC_CF</sub>	O
R1	A00	Address bit 0 connected to card	V <sub>CC_CF</sub>	O
T1	D00	Data bit 0 connected to card	V <sub>CC_CF</sub>	I/O
U1	D01	Data bit 1 connected to card	V <sub>CC_CF</sub>	I/O
V1	D02	Data bit 2 connected to card	V <sub>CC_CF</sub>	I/O
W1	WP	Write protect connected to card. Pulled up to V <sub>CC_CF</sub> through 100 k $\Omega$ .	V <sub>CC_CF</sub>	I
A2	D04	Data bit 4 connected to card	V <sub>CC_CF</sub>	I/O
B2	D05	Data bit 5 connected to card	V <sub>CC_CF</sub>	I/O
C2	D06	Data bit 6 connected to card	V <sub>CC_CF</sub>	I/O
D2	D07	Data bit 7 connected to card	V <sub>CC_CF</sub>	I/O
E2	$\overline{\text{CE1}}$	Card enable connected to card	V <sub>CC_CF</sub>	O
F2	A10	Address bit 10 connected to card	V <sub>CC_CF</sub>	O
G2	$\overline{\text{IOR\!D}}$	I/O read connected to card	V <sub>CC_CF</sub>	O
H2	$\overline{\text{IOWR}}$	I/O write connected to card	V <sub>CC_CF</sub>	O
J2	$\overline{\text{WE}}$	Write enable connected to card	V <sub>CC_CF</sub>	O
K2	READY	Ready connected to card. Pulled up to V <sub>CC_CF</sub> through 100 k $\Omega$ .	V <sub>CC_CF</sub>	I
L2	RESET	Reset connected to card	V <sub>CC_CF</sub>	O
M2	$\overline{\text{WAIT}}$	Wait connected to card. Pulled up to V <sub>CC_CF</sub> through 100 k $\Omega$ .	V <sub>CC_CF</sub>	I
N2	$\overline{\text{INPACK}}$	Input acknowledge connected to card. Pulled up to V <sub>CC_CF</sub> through 100 k $\Omega$ .	V <sub>CC_CF</sub>	I
P2	$\overline{\text{REG}}$	Register connected to card	V <sub>CC_CF</sub>	O
R2	BVD2	BVD2 connected to card. Pulled up to V <sub>CC_CF</sub> through 100 k $\Omega$ .	V <sub>CC_CF</sub>	I
T2	BVD1	BVD1 connected to card. Pulled up to V <sub>CC_CF</sub> through 100 k $\Omega$ .	V <sub>CC_CF</sub>	I
U2	D08	Data bit 8 connected to card	V <sub>CC_CF</sub>	I/O
V2	D09	Data bit 9 connected to card	V <sub>CC_CF</sub>	I/O
W2	D10	Data bit 10 connected to card	V <sub>CC_CF</sub>	I/O
A3	D03	Data bit 3 connected to card	V <sub>CC_CF</sub>	I/O
B3	D11	Data bit 11 connected to card	V <sub>CC_CF</sub>	I/O
C3	SD15	Data bit 15 connected to controller	V <sub>CC_S</sub>	I/O
D3	V <sub>CC_CF</sub>	Card-side supply voltage. V <sub>CC_CF</sub> powers all card-side inputs, outputs, and I/Os.		Power
E3	GND	Ground		
F3	V <sub>CC_CF</sub>	Card-side supply voltage. V <sub>CC_CF</sub> powers all card-side inputs, outputs, and I/Os.		Power
G3	GND	Ground		

(1) I = input, O = output, I/O = input/output

**TERMINAL FUNCTIONS (continued)**

TERMINAL		DESCRIPTION	REFERENCED TO	I/O <sup>(1)</sup>
NO.	NAME			
H3	V <sub>CC_CF</sub>	Card-side supply voltage. V <sub>CC_CF</sub> powers all card-side inputs, outputs, and I/Os.		Power
J3	GND	Ground		
K3	A05	Address bit 5 connected to card	V <sub>CC_CF</sub>	O
L3	GND	Ground		
M3	V <sub>CC_CF</sub>	Card-side supply voltage. V <sub>CC_CF</sub> powers all card-side inputs, outputs, and I/Os.		Power
N3	GND	Ground		
P3	V <sub>CC_CF</sub>	Card-side supply voltage. V <sub>CC_CF</sub> powers all card-side inputs, outputs, and I/Os.		Power
R3	V <sub>CC_CF</sub>	Card-side supply voltage. V <sub>CC_CF</sub> powers all card-side inputs, outputs, and I/Os.		Power
T3	V <sub>CC_SD</sub>	Card-detect supply voltage. V <sub>CC_SD</sub> powers the card-detect circuitry.		Power
U3	$\overline{CD1}$	Card detect connected to card. Pulled up to V <sub>CC_CF</sub> through 100 k $\Omega$ .	V <sub>CC_SD</sub>	I
V3	$\overline{CD2}$	Card detect connected to card. Pulled up to V <sub>CC_CF</sub> through 100 k $\Omega$ .	V <sub>CC_SD</sub>	I
W3	$\overline{SCD}$	Card detect connected to controller	V <sub>CC_SD</sub>	O
A4	SD14	Data bit 14 connected to controller	V <sub>CC_s</sub>	I/O
B4	SD13	Data bit 13 connected to controller	V <sub>CC_s</sub>	I/O
C4	$\overline{SINPACK}$	Input acknowledge connected to controller	V <sub>CC_s</sub>	I/O
D4	V <sub>CC_s</sub>	Controller-side supply voltage. V <sub>CC_s</sub> powers all controller-side inputs, outputs, and I/Os.		Power
E4	GND	Ground		
F4	V <sub>CC_s</sub>	Controller-side supply voltage. V <sub>CC_s</sub> powers all controller-side inputs, outputs, and I/Os.		Power
G4	GND	Ground		
H4	V <sub>CC_s</sub>	Controller-side supply voltage. V <sub>CC_s</sub> powers all controller-side inputs, outputs, and I/Os.		Power
J4	GND	Ground		
K4	$\overline{SCE2}$	Card enable connected to controller	V <sub>CC_s</sub>	I
L4	GND	Ground		
M4	V <sub>CC_s</sub>	Controller-side supply voltage. V <sub>CC_s</sub> powers all controller-side inputs, outputs, and I/Os.		Power
N4	GND	Ground		
P4	GND	Ground		
R4	V <sub>CC_s</sub>	Controller-side supply voltage. V <sub>CC_s</sub> powers all controller-side inputs, outputs, and I/Os.		Power
T4	DIR( $\overline{S}/CF$ )	Direction controls flow of data from system to CF and vice-versa	V <sub>CC_s</sub>	I
U4	DIR_OUT	Data direction generated by CF4320H. Can be connected to DIR( $\overline{S}/CF$ ).	V <sub>CC_s</sub>	O
V4	SAO0	Address bit 0 connected to controller	V <sub>CC_s</sub>	I
W4	SAO1	Address bit 1 connected to controller	V <sub>CC_s</sub>	I
A5	SD12	Data bit 12 connected to controller	V <sub>CC_s</sub>	I/O
B5	SD10	Data bit 10 connected to controller	V <sub>CC_s</sub>	I/O
C5	SD08	Data bit 8 connected to controller	V <sub>CC_s</sub>	I/O
D5	SD06	Data bit 6 connected to controller	V <sub>CC_s</sub>	I/O
E5	SD04	Data bit 4 connected to controller	V <sub>CC_s</sub>	I/O
F5	SD02	Data bit 2 connected to controller	V <sub>CC_s</sub>	I/O
G5	SD00	Data bit 0 connected to controller	V <sub>CC_s</sub>	I/O
H5	$\overline{ENL}$	Enable for data bits 0–7. Pulled up to V <sub>CC_s</sub> through 100 k $\Omega$ .	V <sub>CC_s</sub>	I
J5	$\overline{MASTER\_EN}$	Enable for all transceivers and buffers except the card-detect circuitry	V <sub>CC_s</sub>	I
K5	$\overline{SOE}$	Output enable connected to controller	V <sub>CC_s</sub>	I
L5	$\overline{SWE}$	Write enable connected to controller	V <sub>CC_s</sub>	I
M5	SREADY	Ready connected to controller	V <sub>CC_s</sub>	O

**TERMINAL FUNCTIONS (continued)**

TERMINAL		DESCRIPTION	REFERENCED TO	I/O <sup>(1)</sup>
NO.	NAME			
N5	$\overline{\text{SWAIT}}$	Wait connected to controller	V <sub>CC_S</sub>	O
P5	SBVD2	BVD2 connected to controller	V <sub>CC_S</sub>	O
R5	SA10	Address bit 10 connected to controller	V <sub>CC_S</sub>	I
T5	SA08	Address bit 8 connected to controller	V <sub>CC_S</sub>	I
U5	SA06	Address bit 6 connected to controller	V <sub>CC_S</sub>	I
V5	SA04	Address bit 4 connected to controller	V <sub>CC_S</sub>	I
W5	SA02	Address bit 2 connected to controller	V <sub>CC_S</sub>	I
A6	SD11	Data bit 11 connected to controller	V <sub>CC_S</sub>	I/O
B6	SD09	Data bit 9 connected to controller	V <sub>CC_S</sub>	I/O
C6	SD07	Data bit 7 connected to controller	V <sub>CC_S</sub>	I/O
D6	SD05	Data bit 5 connected to controller	V <sub>CC_S</sub>	I/O
E6	SD03	Data bit 3 connected to controller	V <sub>CC_S</sub>	I/O
F6	SD01	Data bit 1 connected to controller	V <sub>CC_S</sub>	I/O
G6	$\overline{\text{SCE1}}$	Card enable connected to controller	V <sub>CC_S</sub>	I
H6	$\overline{\text{ENH}}$	Enable for data bits 8–15. Pulled up to V <sub>CC_S</sub> through 100 k $\Omega$ .	V <sub>CC_S</sub>	I
J6	$\overline{\text{BUF\_EN}}$	Enable for address and control/status lines. Pulled up to V <sub>CC_S</sub> through 100 k $\Omega$ .	V <sub>CC_S</sub>	I
K6	$\overline{\text{SIORD}}$	I/O read connected to controller	V <sub>CC_S</sub>	I
L6	$\overline{\text{SIOWR}}$	I/O write connected to controller	V <sub>CC_S</sub>	I
M6	SRESET	Reset connected to controller	V <sub>CC_S</sub>	I
N6	$\overline{\text{SREG}}$	Register connected to controller	V <sub>CC_S</sub>	I
P6	SBVD1	BVD1 connected to controller	V <sub>CC_S</sub>	O
R6	SWP	Write protect connected to controller	V <sub>CC_S</sub>	O
T6	SA09	Address bit 9 connected to controller	V <sub>CC_S</sub>	I
U6	SA07	Address bit 7 connected to controller	V <sub>CC_S</sub>	I
V6	SA05	Address bit 5 connected to controller	V <sub>CC_S</sub>	I
W6	SA03	Address bit 3 connected to controller	V <sub>CC_S</sub>	I



LOGIC DIAGRAM

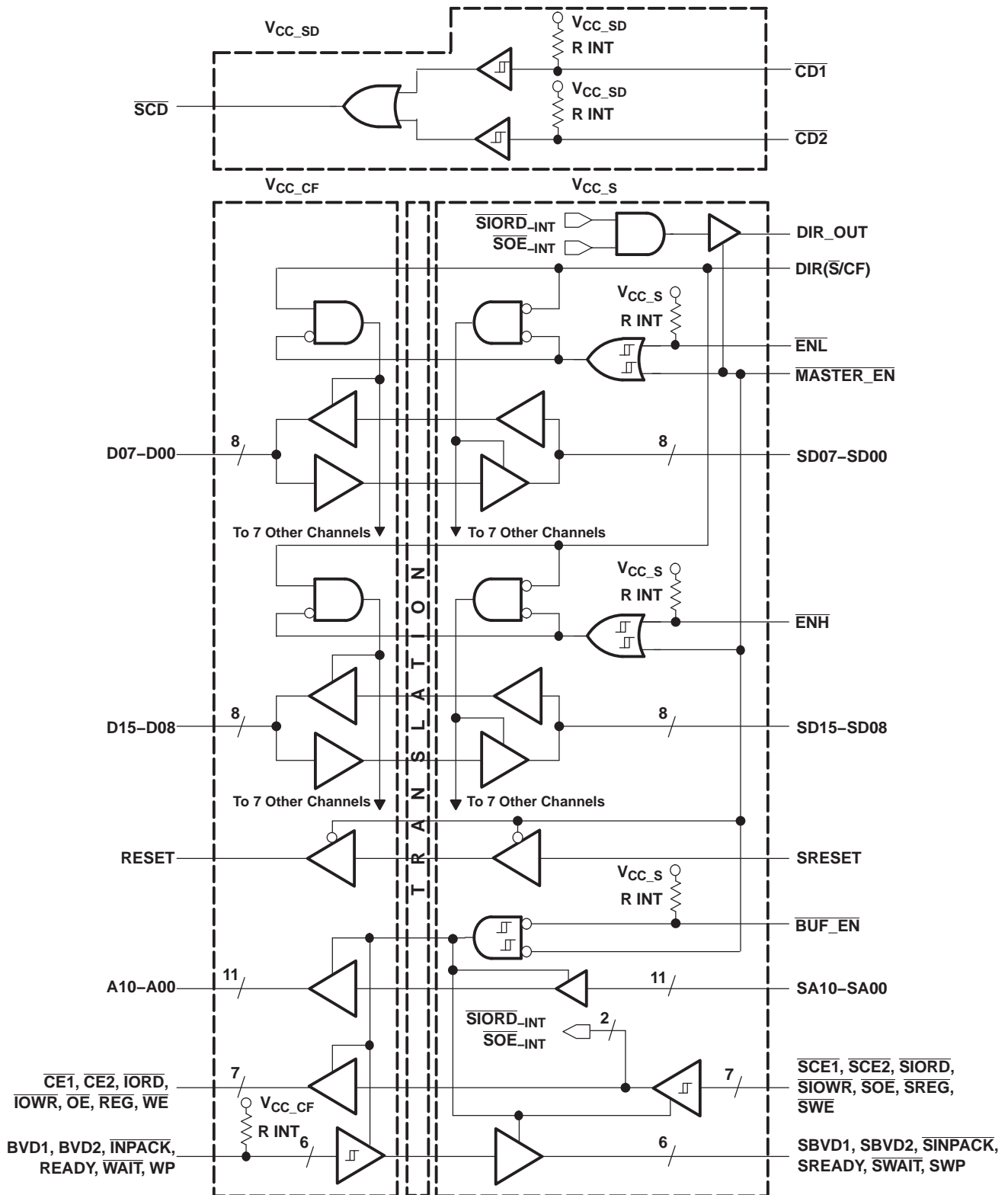

NOTE:  $R_{INT} \geq 100 \text{ k}\Omega$

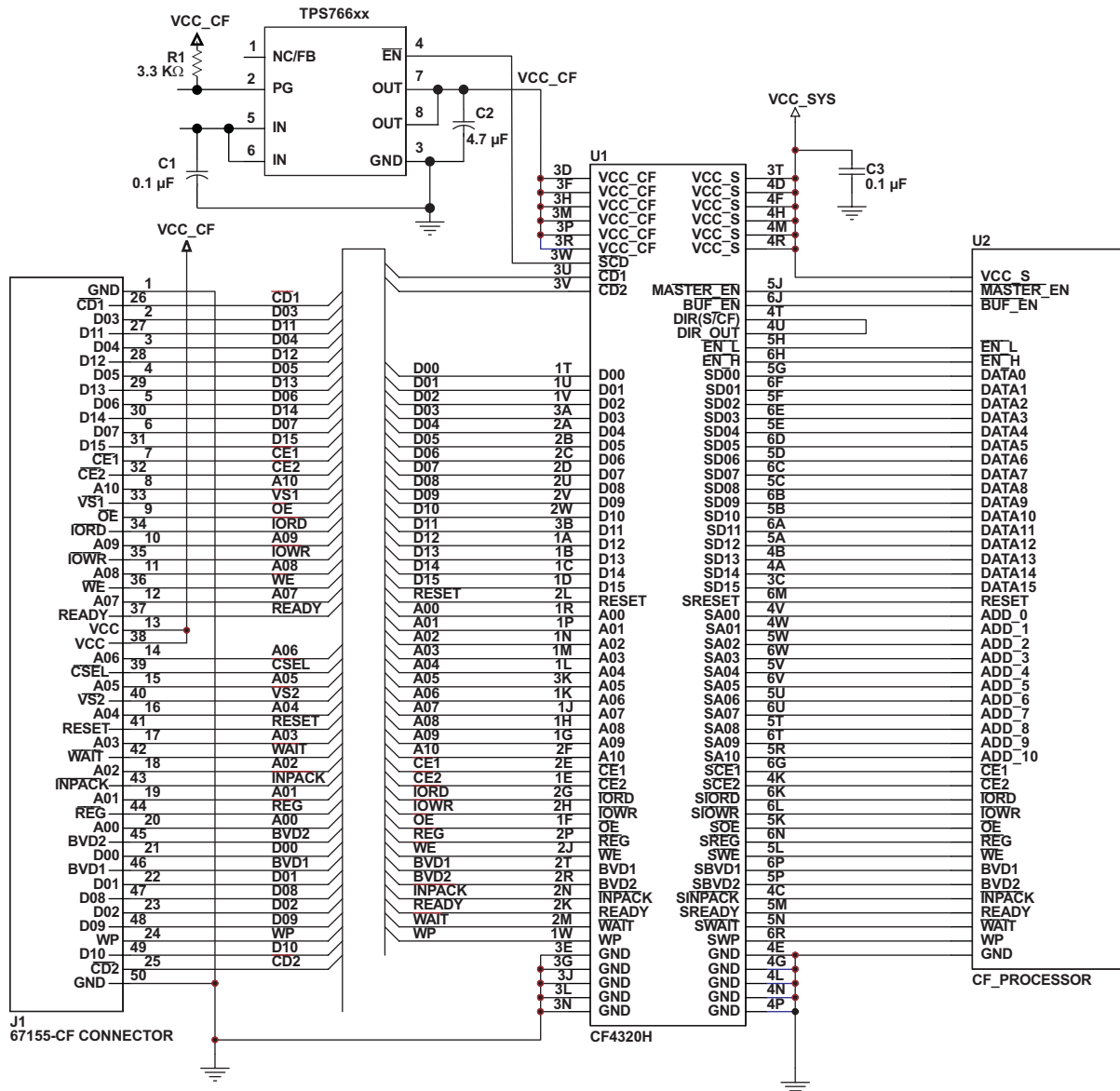

**Absolute Maximum Ratings<sup>(1)</sup>**

over operating free-air temperature range (unless otherwise noted)

				MIN	MAX	UNIT
$V_{CC\_S}$	Supply voltage range			-0.5	4.6	V
$V_{CC\_CF}$				-0.5	6.5	
$V_{CC\_SD}$						
$V_I$	Input voltage range	I/O ports	SD, SA <sup>(2)</sup>	-0.5	4.6	V
			D, A	-0.5	6.5	
		Input ports	$\overline{SCE1}$ , $\overline{SCE2}$ , $\overline{SIORD}$ , $\overline{SIOWR}$ , $\overline{SOE}$ , $\overline{SREG}$ , $\overline{SWE}$	-0.5	4.6	
			BVD1, BVD2, READY, INPACK, WAIT, WP	-0.5	6.5	
Control ports	$\overline{DIR}(\overline{S}/CF)$ , $\overline{MASTER\_EN}$ , ENL, ENH	-0.5	4.6			
$V_O$	Voltage range applied to any output in the high-impedance or power-off state <sup>(2)</sup>	System port		-0.5	4.6	V
		CF port		-0.5	6.5	
$V_O$	Voltage range applied to any output in the high or low state <sup>(2) (3)</sup>	System port		-0.5	$V_{CC\_S} + 0.5$	V
		CF port		-0.5	$V_{CC\_CF} + 0.5$	
$I_{IK}$	Input clamp current	$V_I < 0$			-50	mA
$I_{OK}$	Output clamp current	$V_O < 0$			-50	mA
$I_O$	Continuous output current				±50	mA
	Continuous current through each $V_{CC\_S}$ , $V_{CC\_CF}$ , $V_{CC\_SD}$ , or GND				±100	mA
$\theta_{JA}$	Package thermal impedance <sup>(4)</sup>				36	°C/W
$T_{stg}$	Storage temperature range			-65	150	°C

- (1) Stresses beyond those listed under "absolute maximum ratings" may cause permanent damage to the device. These are stress ratings only, and functional operation of the device at these or any other conditions beyond those indicated under "recommended operating conditions" is not implied. Exposure to absolute-maximum-rated conditions for extended periods may affect device reliability.
- (2) The input and output negative-voltage ratings may be exceeded if the input and output current ratings are observed.
- (3) This value is limited to 6.5 V maximum.
- (4) The package thermal impedance is calculated in accordance with JESD 51-7.

**Recommended Operating Conditions**<sup>(1) (2) (3)</sup>

			V <sub>CCI</sub>	V <sub>CCO</sub>	MIN	MAX	UNIT
V <sub>CC_SD</sub>	Card-detect supply voltage				1.65	5.5	V
V <sub>CC_S</sub>	System-side supply voltage				1.65	V <sub>CC_CF</sub>	V
V <sub>CC_CF</sub>	CF-side supply voltage				3	5.5	V
V <sub>IH</sub>	High-level input voltage	Card-detect inputs (CD1, CD2)	1.65 V to 5.5 V		V <sub>CC_SD</sub> × 0.65		V
V <sub>IL</sub>	Low-level input voltage	Card-detect inputs (CD1, CD2)	1.65 V to 5.5 V		V <sub>CC_SD</sub> × 0.35		V
V <sub>IH</sub>	High-level input voltage	System port (SD, SA, SRESET)	1.65 V to 1.95 V		V <sub>CC_S</sub> × 0.65		V
			1.95 V to 2.7 V		1.7		
			2.7 V to 3.6 V		2		
V <sub>IL</sub>	Low-level input voltage	System port (SD, SA, SRESET)	1.65 V to 1.95 V		V <sub>CC_S</sub> × 0.35		V
			1.95 V to 2.7 V		0.7		
			2.7 V to 3.6 V		0.8		
V <sub>IH</sub>	High-level input voltage	Control inputs (DIR, MASTER_EN, ENL, ENH, BUF_EN)	1.65 V to 1.95 V		V <sub>CC_S</sub> × 0.65		V
			1.95 V to 2.7 V		1.7		
			2.7 V to 3.6 V		2		
V <sub>IL</sub>	Low-level input voltage	Control inputs (DIR, MASTER_EN, ENL, ENH, BUF_EN)	1.65 V to 1.95 V		V <sub>CC_S</sub> × 0.35		V
			1.95 V to 2.7 V		0.7		
			2.7 V to 3.6 V		0.8		
V <sub>IH</sub>	High-level input voltage	CF port (D, A)	3 V to 3.6 V		2		V
			4.5 V to 5.5 V		V <sub>CC_CF</sub> × 0.7		
V <sub>IL</sub>	Low-level input voltage	CF port (D, A)	3 V to 3.6 V		0.8		V
			4.5 V to 5.5 V		V <sub>CC_CF</sub> × 0.3		
V <sub>O</sub>	Card-detect output voltage				0	V <sub>CC_SD</sub>	V
	System-side output voltage				0	V <sub>CC_S</sub>	
	CF-side output voltage				0	V <sub>CC_CF</sub>	
I <sub>OH</sub>	High-level output current	Card detect		1.65 V to 1.95 V	–2		mA
				1.95 V to 2.7 V	–4		
				2.7 V to 3.6 V	–8		
				4.5 V to 5.5 V	–12		
I <sub>OL</sub>	Low-level output current	Card detect		1.65 V to 1.95 V	2		mA
				1.95 V to 2.7 V	4		
				2.7 V to 3.6 V	8		
				4.5 V to 5.5 V	12		
I <sub>OH</sub>	High-level output current	System port		1.65 V to 1.95 V	2		mA
				1.95 V to 2.7 V	6		
				2.7 V to 3.6 V	12		
I <sub>OL</sub>	Low-level output current	System port		1.65 V to 1.95 V	2		mA
				1.95 V to 2.7 V	6		
				2.7 V to 3.6 V	12		
I <sub>OH</sub>	High-level output current	CF port		3 V to 3.6 V	12		mA
				4.5 V to 5.5 V	16		
I <sub>OL</sub>	Low-level output current	CF port		3 V to 3.6 V	12		mA
				4.5 V to 5.5 V	16		

(1) V<sub>CCI</sub> is the V<sub>CC</sub> associated with the input port.(2) V<sub>CCO</sub> is the V<sub>CC</sub> associated with the output port.(3) All unused data inputs of the device must be held at V<sub>CCI</sub> or GND to ensure proper device operation. Refer to the TI application report, *Implications of Slow or Floating CMOS Inputs*, literature number SCBA004.

**Recommended Operating Conditions<sup>(1) (2) (3)</sup> (continued)**

		V <sub>CCI</sub>	V <sub>CCO</sub>	MIN	MAX	UNIT
Δt/Δv	Input transition rise or fall rate	1.65 V to 2.7 V			>20	ns/V
		2.7 V to 3.6 V			>20	
		4.5 V to 5.5 V			>20	
T <sub>A</sub>	Operating free-air temperature			-40	85	°C

**Electrical Characteristics**

over recommended operating free-air temperature range (CF card-detect logic) (unless otherwise noted)

PARAMETER	TEST CONDITIONS		V <sub>CC_SD</sub>	T <sub>A</sub> = 25°C			-40°C to 85°C		UNIT
				MIN	TYP	MAX	MIN	MAX	
V <sub>OH</sub>	V <sub>I</sub> = V <sub>IH</sub>	I <sub>OH</sub> = -100 μA	1.65 V to 5.5 V	V <sub>CC_SD</sub> - 0.1			V <sub>CC_SD</sub> - 0.2		V
		I <sub>OH</sub> = -2 mA	1.65 V	1.2			1.2		
		I <sub>OH</sub> = -4 mA	2.3 V	2			2		
		I <sub>OH</sub> = -6 mA	2.7 V	2.3			2.3		
		I <sub>OH</sub> = -8 mA	3 V	2.4			2.4		
		I <sub>OH</sub> = -12 mA	4.5 V	3.8			3.8		
V <sub>OL</sub>	V <sub>I</sub> = V <sub>IL</sub>	I <sub>OL</sub> = 100 μA	1.65 V to 5.5 V				0.1		V
		I <sub>OL</sub> = 2 mA	1.65 V				0.2		
		I <sub>OL</sub> = 4 mA	2.3 V				0.2		
		I <sub>OL</sub> = 6 mA	2.7 V				0.3		
		I <sub>OL</sub> = 8 mA	3 V				0.4		
		I <sub>OL</sub> = 12 mA	4.5 V				0.5		
I <sub>I</sub>	V <sub>I</sub> = V <sub>CC_SD</sub>	1.65 V to 5.5 V				±0.5		μA	
	V <sub>I</sub> = 0 V					-55			
I <sub>off</sub>	V <sub>I</sub> or V <sub>O</sub> = 0 to 5.5 V	0 V				55		μA	
R <sub>INT</sub>	$\overline{CD1} = \text{GND}, \overline{CD2} = \text{GND}$	1.65 V to 5.5 V	150			300		kΩ	
I <sub>CC_SD</sub>	$\overline{CD1}$ and $\overline{CD2} = V_{CC\_SD},$ I <sub>O_SD</sub> = 0	5.5 V				0.5		μA	
	$\overline{CD1}$ or $\overline{CD2} = \text{GND},$ $\overline{CD2}$ or $\overline{CD1} = V_{CC\_SD},$ I <sub>O_SD</sub> = 0					10			
C <sub>I</sub>	$\overline{CD1}$ or $\overline{CD2}$	V <sub>I</sub> = V <sub>CC_SD</sub> or GND	5.5 V	9					pF

**Electrical Characteristics**<sup>(1) (2)</sup>

over recommended operating free-air temperature range (unless otherwise noted)

PARAMETER		TEST CONDITIONS		V <sub>CC_S</sub>	V <sub>CC_CF</sub>	T <sub>A</sub> = 25°C			–40°C to 85°C		UNIT
						MIN	TYP	MAX	MIN	MAX	
V <sub>T+</sub>	<u>SOE</u> , <u>SCE1</u> , <u>SCE2</u> , <u>SIORD</u> , <u>SIOWR</u> , <u>SWE</u> , <u>SREG</u>			1.65 V	3 V to 5.5 V	0.95			0.6	1.4	V
				2.3 V		1.32			0.9	1.8	
				2.7 V		1.49			1	2	
				3 V		1.67			1.2	2.2	
V <sub>T–</sub>	<u>SOE</u> , <u>SCE1</u> , <u>SCE2</u> , <u>SIORD</u> , <u>SIOWR</u> , <u>SWE</u> , <u>SREG</u>			1.65 V	3 V to 5.5 V	0.66			0.19	0.8	V
				2.3 V		0.87			0.39	1.15	
				2.7 V		0.98			0.49	1.32	
				3 V		1.08			0.59	1.5	
ΔV <sub>T</sub>	<u>SOE</u> , <u>SCE1</u> , <u>SCE2</u> , <u>SIORD</u> , <u>SIOWR</u> , <u>SWE</u> , <u>SREG</u>			1.65 V	3 V to 5.5 V	0.31			0.1	0.7	V
				2.3 V		0.46			0.25	0.7	
				2.7 V		0.52			0.3	0.9	
				3 V		0.61			0.4	0.9	
V <sub>T+</sub>	BVD1, BVD2, READY, INPACK, WAIT			1.65 V to 3.6 V	3 V	1.67			1.3	2.2	V
				4.5 V	2.44			1.9	3.1		
V <sub>T–</sub>	BVD1, BVD2, READY, INPACK, WAIT, WP			1.65 V to 3.6 V	3 V	1.11			0.6	1.5	V
				4.5 V	1.43			1	2		
ΔV <sub>T</sub>	BVD1, BVD2, READY, INPACK, WAIT			1.65 V to 3.6 V	3 V	0.58			0.35	1	V
				4.5 V	1.02			0.6	1.5		
V <sub>T+</sub>	<u>BUF_EN</u> , <u>ENH</u> , <u>ENL</u> , <u>MASTER_EN</u>			1.65 V	3 V to 5.5 V	1			0.6	1.4	V
				2.3 V		1.37			1.1	1.8	
				2.7 V		1.54			1.1	2	
				3 V		1.72			1.3	2.2	
V <sub>T–</sub>	<u>BUF_EN</u> , <u>ENH</u> , <u>ENL</u> , <u>MASTER_EN</u>			1.65 V	3 V to 5.5 V	0.34			0.15	1	V
				2.3 V		0.63			0.15	1.2	
				2.7 V		0.75			0.2	1.32	
				3 V		0.88			0.4	1.5	
ΔV <sub>T</sub>	<u>BUF_EN</u> , <u>ENH</u> , <u>ENL</u> , <u>MASTER_EN</u>			1.65 V	3 V to 5.5 V	0.67			0.08	1.1	V
				2.3 V		0.76			0.2	1.2	
				2.7 V		0.8			0.26	1.3	
				3 V		0.86			0.3	1.4	
V <sub>OH_S</sub>		V <sub>I</sub> = V <sub>IH</sub>	I <sub>OH</sub> = –100 μA	1.65 V to 3.6 V	3 V to 5.5 V	V <sub>CC_S</sub> – 0.1			V <sub>CC_S</sub> – 0.2		V
			I <sub>OH</sub> = –2 mA	1.65 V		1.2			1.2		
			I <sub>OH</sub> = –4 mA	2.3 V		2			2		
			I <sub>OH</sub> = –6 mA	2.7 V		2.3			2.3		
			I <sub>OH</sub> = –12 mA	3 V		2.4			2.4		
V <sub>OL_S</sub>		V <sub>I</sub> = V <sub>IL</sub>	I <sub>OL</sub> = 100 μA	1.65 V to 3.6 V	3 V to 5.5 V				0.1	0.2	V
			I <sub>OL</sub> = 2 mA	1.65 V					0.2	0.2	
			I <sub>OL</sub> = 4 mA	2.3 V					0.2	0.2	
			I <sub>OL</sub> = 6 mA	2.7 V					0.3	0.3	
			I <sub>OL</sub> = 12 mA	3 V					0.5	0.5	

(1) V<sub>CCI</sub> is the V<sub>CC</sub> associated with the input port.(2) V<sub>CCO</sub> is the V<sub>CC</sub> associated with the output port.

**Electrical Characteristics<sup>(1) (2) (continued)</sup>**

over recommended operating free-air temperature range (unless otherwise noted)

PARAMETER	TEST CONDITIONS		V <sub>CC_S</sub>	V <sub>CC_CF</sub>	T <sub>A</sub> = 25°C			–40°C to 85°C		UNIT		
					MIN	TYP	MAX	MIN	MAX			
V <sub>OH_CF</sub>	V <sub>I</sub> = V <sub>IH</sub>	I <sub>OH</sub> = –100 μA	1.65 V to 3.6 V	3 V to 5.5 V	V <sub>CC_CF</sub> – 0.1		V <sub>CC_CF</sub> – 0.2		V			
		I <sub>OH</sub> = 12 mA		3 V						2.4	2.4	
		I <sub>OH</sub> = 16 mA		5.5 V						3.8	3.8	
V <sub>OL_CF</sub>	V <sub>I</sub> = V <sub>IL</sub>	I <sub>OL</sub> = 100 μA	1.65 V to 3.6 V	3 V to 5.5 V					V			
		I <sub>OL</sub> = 12 mA		3 V							0.1	0.2
		I <sub>OL</sub> = 16 mA		5.5 V							0.5	0.5
I <sub>I</sub>	Inputs without pullup resistor	V <sub>I</sub> = GND to V <sub>CC1</sub> <sup>(3)</sup>	1.65 V to 3.6 V	3.6 V to 5.5 V					μA			
	Inputs with pullup resistor	V <sub>I</sub> = V <sub>CC1</sub> <sup>(3)</sup> V <sub>I</sub> = 0 V		3 V to 5.5 V							±0.5	±1
I <sub>off</sub>	S port	V <sub>I</sub> or V <sub>O</sub> = 0 to 5.5 V	0 V	0 to 5.5 V					μA			
	CF port		0 to 3.6 V	0 V		±0.5	±1					
I <sub>OZ</sub> <sup>(4)</sup>	S or CF output ports	V <sub>O</sub> = V <sub>CCO</sub> or GND,	3.6 V	5.5 V					μA			
	CF outputs	V <sub>I</sub> = V <sub>CC1</sub> or GND		0 V		±0.5	±1					
I <sub>CC_S</sub>	Inputs (SD15–SD00, SA10–SA00, SCE1, SCE2, SIORD, SIOWR, SOE, SREG, SWE)	V <sub>I</sub> = V <sub>CC_S</sub> or GND	1.65 V to 3.6 V	3.6 V to 5.5 V		1.5		3	μA			
	Control inputs (ENL, ENH, BUF_EN)	ENL = ENH = BUF_EN = V <sub>CC_S</sub> One of ENL, ENH, BUF_EN = GND, Others = V <sub>CC_S</sub>			I <sub>O</sub> = 0, DIR( $\overline{S}$ /CF) = V <sub>CC_S</sub> , All other inputs = V <sub>CC_S</sub> or GND		1.5	36		36		

 (1) V<sub>CC1</sub> is the V<sub>CC</sub> associated with the input port.

 (2) V<sub>CCO</sub> is the V<sub>CC</sub> associated with the output port.

 (3) V<sub>CC1</sub> = V<sub>CC\_S</sub> for DIR( $\overline{S}$ /CF), ENL, ENH, SD15–SD00, SA10–SA00,  $\overline{MASTER\_EN}$ , SRESET,  $\overline{SCE1}$ ,  $\overline{SCE2}$ ,  $\overline{SIORD}$ ,  $\overline{SIOWR}$ ,  $\overline{SOE}$ , SREG, SWE, BUF\_EN

 V<sub>CC1</sub> = V<sub>CC\_CF</sub> for D15–D00, BVD1, BVD2,  $\overline{INPACK}$ , READY,  $\overline{WAIT}$ , WP

 (4) For I/O ports, the parameter I<sub>OZ</sub> includes the input leakage current.

## Electrical Characteristics (continued)

over recommended operating free-air temperature range (unless otherwise noted)

PARAMETER		TEST CONDITIONS		$V_{CC\_S}$	$V_{CC\_CF}$	$T_A = 25^\circ\text{C}$			$-40^\circ\text{C to } 85^\circ\text{C}$		UNIT
						MIN	TYP	MAX	MIN	MAX	
$I_{CC\_CF}$	Input (D15–D00)	$V_I = V_{CC\_CF}$ or GND	$I_O = 0$ , $\overline{DIR}(\overline{S}/CF) = \text{GND}$ , BVD1, BVD2, INPACK, READY, WAIT, WP = $V_{CC\_CF}$	1.65 V to 3.6 V	3 V to 5.5 V		1.5			3	$\mu\text{A}$
	Inputs (BVD1, BVD2, INPACK, READY, WAIT, WP)	BVD1 = BVD2 = INPACK = READY WAIT = WP = $V_{CC\_CF}$	$I_O = 0$ , $\overline{DIR}(\overline{S}/CF) = \text{GND}$ , D15–D00 = $V_{CC\_CF}$ or GND				1.5		3		
		One of BVD1, BVD2, INPACK, READY, WAIT, WP = GND, All others = $V_{CC\_CF}$	$I_O = 0$ , $\overline{DIR}(\overline{S}/CF) = \text{GND}$ , D15–D00 = $V_{CC\_CF}$ or GND				60		60		
$R_{INT}$				1.65 V to 3.6 V	3 V to 5.5 V		150	300		300	k $\Omega$
$C_I$	Control inputs	$V_I = 3.3\text{ V or GND}$		3.3 V	3.3 V		3				pF
	$\overline{SA}_{xx}$ , $\overline{SOE}$ , SCE1, SCE2, SIORD, SIOWR, SREG, SWE						3				
	Axx, BVD1, BVD2, READY, INPACK, WAIT, WP						9				
$C_{IO}$	S I/O ports	$V_O = 3.3\text{ V or GND}$		3.3 V	3.3 V		7				pF
	CF I/O ports						12				



## Switching Characteristics

 over recommended operating free-air temperature range ( $\overline{CD1}$ ,  $\overline{CD2}$ ) (see [Figure 1](#))

PARAMETER	FROM (INPUT)	TO (OUTPUT)	$V_{CC\_SD}$	$T_A = 25^\circ\text{C}$			$-40^\circ\text{C to } 85^\circ\text{C}$		UNIT
				MIN	TYP	MAX	MIN	MAX	
$t_{pd}$	$\overline{CD1}$ or $\overline{CD2}$	$\overline{SCD}$	$1.8\text{ V} \pm 0.15\text{ V}$	3.1	7.1	13.5	1.8	15.5	ns
			$2.5\text{ V} \pm 0.2\text{ V}$	2.7	4.6	7.1	1.6	9.1	
			$2.7\text{ V}$	2.4	4	5.7	1.6	9.1	
			$3.3\text{ V} \pm 0.3\text{ V}$	2	3.4	5.1	1.2	6.8	
			$5\text{ V} \pm 0.5\text{ V}$	1.7	2.6	3.6	1	5.5	

## Switching Characteristics

 over recommended operating free-air temperature range ( $\overline{BVD1}$ ,  $\overline{BVD2}$ ,  $\overline{INPACK}$ ,  $\overline{READY}$ ,  $\overline{WAIT}$ ,  $\overline{WP}$ ) (see [Figure 1](#))

PARAMETER	FROM (INPUT)	TO (OUTPUT)	TEST CONDITIONS	$V_{CC\_S}$	$V_{CC\_CF}$	$T_A = 25^\circ\text{C}$			$-40^\circ\text{C to } 85^\circ\text{C}$		UNIT
						MIN	TYP	MAX	MIN	MAX	
$t_{pd}$	CF input	S output	$\overline{MASTER\_EN} = \overline{BUF\_EN} = V_{IL}$	$1.8\text{ V} \pm 0.15\text{ V}$	$3.3\text{ V} \pm 0.3\text{ V}$	3.1	6	10.2	2.4	12.9	ns
					$5\text{ V} \pm 0.5\text{ V}$	2.9	5.6	9.6	2.2	13.9	
				$2.5\text{ V} \pm 0.2\text{ V}$	$3.3\text{ V} \pm 0.3\text{ V}$	2.7	4.6	6.5	1.9	10	
					$5\text{ V} \pm 0.5\text{ V}$	2.5	4.2	5.8	1.7	8.6	
				$3.3\text{ V} \pm 0.3\text{ V}$	$3.3\text{ V} \pm 0.3\text{ V}$	2.5	4	5.6	1.6	8.8	
					$5\text{ V} \pm 0.5\text{ V}$	2.3	3.6	4.9	1.5	7	
$t_{en}$	$\overline{MASTER\_EN}$	S output	$\overline{BUF\_EN} = V_{IL}$	$1.8\text{ V} \pm 0.15\text{ V}$	$3.3\text{ V} \pm 0.3\text{ V}$	11.1	18.9	30.7	9.2	35.5	ns
					$5\text{ V} \pm 0.5\text{ V}$	11.1	19.3	30.9	8	35.6	
				$2.5\text{ V} \pm 0.2\text{ V}$	$3.3\text{ V} \pm 0.3\text{ V}$	9.9	12.9	17.4	6.9	22.6	
					$5\text{ V} \pm 0.5\text{ V}$	9.9	13.1	17.4	7	22.6	
				$3.3\text{ V} \pm 0.3\text{ V}$	$3.3\text{ V} \pm 0.3\text{ V}$	9.5	11.2	13.4	6.3	18.3	
					$5\text{ V} \pm 0.5\text{ V}$	9.5	11.3	13.5	6.3	18.2	
$t_{dis}$	$\overline{MASTER\_EN}$	S output	$\overline{BUF\_EN} = V_{IL}$	$1.8\text{ V} \pm 0.15\text{ V}$	$3.3\text{ V} \pm 0.3\text{ V}$	6.8	13.7	23.9	6	25.1	ns
					$5\text{ V} \pm 0.5\text{ V}$	6.1	13.4	22	5.4	23.3	
				$2.5\text{ V} \pm 0.2\text{ V}$	$3.3\text{ V} \pm 0.3\text{ V}$	4.9	8.6	13.3	4	14.5	
					$5\text{ V} \pm 0.5\text{ V}$	4.6	8.5	13.6	3.9	14.5	
				$3.3\text{ V} \pm 0.3\text{ V}$	$3.3\text{ V} \pm 0.3\text{ V}$	5	8.1	12.2	4.2	13.2	
					$5\text{ V} \pm 0.5\text{ V}$	4.5	8	12.2	3.6	18.2	
$t_{en}$	$\overline{BUF\_EN}$	S output	$\overline{MASTER\_EN} = V_{IL}$	$1.8\text{ V} \pm 0.15\text{ V}$	$3.3\text{ V} \pm 0.3\text{ V}$	8.7	17.7	33.2	7.6	35.5	ns
					$5\text{ V} \pm 0.5\text{ V}$	10.7	18.3	29.3	8.7	35.6	
				$2.5\text{ V} \pm 0.2\text{ V}$	$3.3\text{ V} \pm 0.3\text{ V}$	9.6	12.4	16.6	6.6	22.6	
					$5\text{ V} \pm 0.5\text{ V}$	9.6	12.6	16.7	6.6	22.6	
				$3.3\text{ V} \pm 0.3\text{ V}$	$3.3\text{ V} \pm 0.3\text{ V}$	9.2	10.9	13	6.1	18.3	
					$5\text{ V} \pm 0.5\text{ V}$	9.2	10.9	13	6.1	18.2	
$t_{dis}$	$\overline{BUF\_EN}$	S output	$\overline{MASTER\_EN} = V_{IL}$	$1.8\text{ V} \pm 0.15\text{ V}$	$3.3\text{ V} \pm 0.3\text{ V}$	6.9	12.9	22.3	5.9	24.2	ns
					$5\text{ V} \pm 0.5\text{ V}$	5.4	12.4	20.5	4.8	22.8	
				$2.5\text{ V} \pm 0.2\text{ V}$	$3.3\text{ V} \pm 0.3\text{ V}$	4.4	8	12.7	3.6	14.5	
					$5\text{ V} \pm 0.5\text{ V}$	4.2	7.9	12.8	3.6	14.2	
				$3.3\text{ V} \pm 0.3\text{ V}$	$3.3\text{ V} \pm 0.3\text{ V}$	4.6	7.7	11.7	3.8	12.3	
					$5\text{ V} \pm 0.5\text{ V}$	4.1	7.6	11.7	3.3	12.4	

## Switching Characteristics

over recommended operating free-air temperature range (data bus I/Os) (see [Figure 1](#))

PARAMETER	FROM (INPUT)	TO (OUTPUT)	TEST CONDITIONS	V <sub>CC,S</sub>	V <sub>CC,CF</sub>	T <sub>A</sub> = 25°C			–40°C to 85°C		UNIT
						MIN	TYP	MAX	MIN	MAX	
t <sub>pd</sub>	D	SD	$\overline{\text{MASTER\_EN}} =$ $\overline{\text{ENL}} = \overline{\text{ENH}} = V_{IL}$	1.8 V ± 0.15 V	3.3 V ± 0.3 V	4.2	7.2	11.8	3	13.7	ns
					5 V ± 0.5 V	3.7	6.4	10.7	2.7	13.9	
				2.5 V ± 0.2 V	3.3 V ± 0.3 V	3.8	5.7	8	2.4	10	
					5 V ± 0.5 V	3.3	4.9	6.8	2.1	12.4	
				3.3 V ± 0.3 V	3.3 V ± 0.3 V	3.5	5.1	6.9	2.2	8.8	
					5 V ± 0.5 V	3	4.3	5.7	1.8	7	
	SD	D		1.8 V ± 0.15 V	3.3 V ± 0.3 V	3.4	5.7	9.8	2.6	11.1	
					5 V ± 0.5 V	3.1	5.4	9.6	2.4	9.6	
				2.5 V ± 0.2 V	3.3 V ± 0.3 V	2.8	4.3	6.2	1.9	8.2	
					5 V ± 0.5 V	2.6	3.8	5.4	1.7	7	
				3.3 V ± 0.3 V	3.3 V ± 0.3 V	2.5	3.7	5.2	1.5	7.2	
					5 V ± 0.5 V	2.2	3.3	4.5	1.4	6	
t <sub>en</sub>	$\overline{\text{MASTER\_EN}}$	D	$\overline{\text{ENL}} = \overline{\text{ENH}} = V_{IL}$	1.8 V ± 0.15 V	3.3 V ± 0.3 V	13.7	18.2	24.4	9.4	27.9	ns
					5.5 V ± 0.5 V	13.7	17.9	29.9	8	31	
				2.5 V ± 0.2 V	3.3 V ± 0.3 V	12.3	15.1	18.8	7.9	23	
					5.5 V ± 0.5 V	12.3	14.8	17.6	8	21.8	
				3.3 V ± 0.3 V	3.3 V ± 0.3 V	11.6	14	17.1	7.3	21.4	
					5.5 V ± 0.5 V	11.6	13.7	15.9	7.4	20.3	
	SD	D		1.8 V ± 0.15 V	3.3 V ± 0.3 V	11.6	19.6	31.8	9.4	36.3	
					5.5 V ± 0.5 V	11.7	20.1	32	9.5	36.2	
				2.5 V ± 0.2 V	3.3 V ± 0.3 V	10.3	13.4	18	7.2	22.6	
					5.5 V ± 0.5 V	10.3	13.6	18.1	7.1	22.6	
				3.3 V ± 0.3 V	3.3 V ± 0.3 V	9.8	11.6	14	6.4	18.3	
					5.5 V ± 0.5 V	9.8	11.7	14	6.4	18.2	
t <sub>dis</sub>	$\overline{\text{MASTER\_EN}}$	D	$\overline{\text{ENL}} = \overline{\text{ENH}} = V_{IL}$	1.8 V ± 0.15 V	3.3 V ± 0.3 V	8.6	12.8	18.1	7.3	20.2	ns
					5.5 V ± 0.5 V	7.6	11.5	16.4	6.3	17.8	
				2.5 V ± 0.2 V	3.3 V ± 0.3 V	7.8	10.8	14.7	6.4	16.4	
					5.5 V ± 0.5 V	6.7	9.4	12.6	5.4	13.8	
				3.3 V ± 0.3 V	3.3 V ± 0.3 V	7.2	9.9	13.4	5.9	15	
					5.5 V ± 0.5 V	6.1	8.6	11.4	4.8	12.5	
	SD	D		1.8 V ± 0.15 V	3.3 V ± 0.3 V	6.9	12.9	21.7	6	24.2	
					5.5 V ± 0.5 V	6.1	12.6	20.8	5.3	22.8	
				2.5 V ± 0.2 V	3.3 V ± 0.3 V	4.9	7.9	11.8	4.1	14.5	
					5.5 V ± 0.5 V	4.7	7.8	11.7	3.9	14.2	
				3.3 V ± 0.3 V	3.3 V ± 0.3 V	5	7.1	9.8	4	12	
					5.5 V ± 0.5 V	4.7	7	9.8	3.8	18.2	

**Switching Characteristics (continued)**

 over recommended operating free-air temperature range (data bus I/Os) (see [Figure 1](#))

PARAMETER	FROM (INPUT)	TO (OUTPUT)	TEST CONDITIONS	V <sub>CC,S</sub>	V <sub>CC,CF</sub>	T <sub>A</sub> = 25°C			–40°C to 85°C		UNIT
						MIN	TYP	MAX	MIN	MAX	
t <sub>en</sub>	$\overline{\text{ENL}}$ or $\overline{\text{ENH}}$	D	$\overline{\text{MASTER\_EN}} = V_{IL}$	1.8 V ± 0.15 V	3.3 V ± 0.3 V	9.4	17.6	23.4	8.3	27.2	ns
					5.5 V ± 0.5 V	13.5	17.4	22.6	7.7	27.8	
				2.5 V ± 0.2 V	3.3 V ± 0.3 V	12.3	15	18.5	7.9	22.8	
					5.5 V ± 0.5 V	12.3	14.7	17.4	8	21.6	
				3.3 V ± 0.3 V	3.3 V ± 0.3 V	11.7	14.1	17	7.3	21.4	
					5.5 V ± 0.5 V	11.6	13.7	16	7.4	20.3	
		SD		1.8 V ± 0.15 V	3.3 V ± 0.3 V	9.5	18.7	30.5	9.1	35.5	
					5.5 V ± 0.5 V	9.6	19.1	30.5	9.1	35.6	
				2.5 V ± 0.2 V	3.3 V ± 0.3 V	10	13	17.4	6.8	22.6	
					5.5 V ± 0.5 V	10	13.2	17.4	6.8	22.6	
				3.3 V ± 0.3 V	3.3 V ± 0.3 V	9.6	11.3	13.6	6.2	18.3	
					5.5 V ± 0.5 V	9.6	11.4	13.6	6.3	18.2	
t <sub>dis</sub>	$\overline{\text{ENL}}$ or $\overline{\text{ENH}}$	D	$\overline{\text{MASTER\_EN}} = V_{IL}$	1.8 V ± 0.15 V	3.3 V ± 0.3 V	8.5	12.1	16.8	7.2	20.2	ns
					5.5 V ± 0.5 V	7.7	10.8	15	6.3	16.6	
				2.5 V ± 0.2 V	3.3 V ± 0.3 V	7.6	10.4	13.8	6.2	16.4	
					5.5 V ± 0.5 V	6.9	9.1	11.9	5.4	13.1	
				3.3 V ± 0.3 V	3.3 V ± 0.3 V	7.3	9.7	12.9	5.9	15	
					5.5 V ± 0.5 V	6.5	8.4	11	5.2	12	
		SD		1.8 V ± 0.15 V	3.3 V ± 0.3 V	6.5	12	20	5.7	24.2	
					5.5 V ± 0.5 V	5.7	11.8	19	5	22.8	
				2.5 V ± 0.2 V	3.3 V ± 0.3 V	4.6	7.4	11.1	3.8	14.5	
					5.5 V ± 0.5 V	4.4	7.3	11.1	3.7	14.2	
				3.3 V ± 0.3 V	3.3 V ± 0.3 V	4.9	6.8	9.3	4	12	
					5.5 V ± 0.5 V	4.3	6.7	9.2	3.5	18.2	

## Switching Characteristics

over recommended operating free-air temperature range (SA10–SA00,  $\overline{\text{SCE1}}$ ,  $\overline{\text{SCE2}}$ ,  $\overline{\text{SIORD}}$ ,  $\overline{\text{SIOWR}}$ ,  $\overline{\text{SOE}}$ ,  $\overline{\text{SREG}}$ ,  $\overline{\text{SWE}}$ ) (see Figure 1)

PARAMETER	FROM (INPUT)	TO (OUTPUT)	TEST CONDITIONS	$V_{CC\_S}$	$V_{CC\_CF}$	$T_A = 25^\circ\text{C}$			$-40^\circ\text{C to } 85^\circ\text{C}$		UNIT			
						MIN	TYP	MAX	MIN	MAX				
$t_{pd}$	S input	CF output (control)	$\overline{\text{MASTER\_EN}} = \overline{\text{BUF\_EN}} = V_{IL}$	$1.8\text{ V} \pm 0.15\text{ V}$	$3.3\text{ V} \pm 0.3\text{ V}$	3.4	6.1	9.8	2.5	10.4	ns			
					$5\text{ V} \pm 0.5\text{ V}$	3	5.8	9.7	2.4	10.2				
				$2.5\text{ V} \pm 0.2\text{ V}$	$3.3\text{ V} \pm 0.3\text{ V}$	2.6	4.5	6.7	1.8	8.4				
		$5\text{ V} \pm 0.5\text{ V}$			2.4	4.1	6	1.7	6.8					
		$3.3\text{ V} \pm 0.3\text{ V}$		$3.3\text{ V} \pm 0.3\text{ V}$	2.2	3.9	5.8	1.4	7					
				$5\text{ V} \pm 0.5\text{ V}$	2	3.5	5	1.3	5.8					
	CF output (A pins)	$\overline{\text{MASTER\_EN}} = \overline{\text{BUF\_EN}} = V_{IL}$	$1.8\text{ V} \pm 0.15\text{ V}$	$3.3\text{ V} \pm 0.3\text{ V}$	3.4	5.7	8.7	2.8	10.3					
				$5\text{ V} \pm 0.5\text{ V}$	3.3	5.4	8.2	2.8	9.7					
			$2.5\text{ V} \pm 0.2\text{ V}$	$3.3\text{ V} \pm 0.3\text{ V}$	2.9	4.3	6.2	1.9	8.4					
				$5\text{ V} \pm 0.5\text{ V}$	2.7	3.9	5.4	1.9	6.8					
			$3.3\text{ V} \pm 0.3\text{ V}$	$3.3\text{ V} \pm 0.3\text{ V}$	2.6	3.7	5.2	1.7	7					
				$5\text{ V} \pm 0.5\text{ V}$	2.3	3.3	4.4	1.5	5.8					
$t_{en}$	$\overline{\text{MASTER\_EN}}$	CF output (control)	$\overline{\text{BUF\_EN}} = V_{IL}$	$1.8\text{ V} \pm 0.15\text{ V}$	$3.3\text{ V} \pm 0.3\text{ V}$	10.8	17.9	24.8	7.9	29.7	ns			
					$5\text{ V} \pm 0.5\text{ V}$	10.8	17.5	26.2	8.1	30.2				
				$2.5\text{ V} \pm 0.2\text{ V}$	$3.3\text{ V} \pm 0.3\text{ V}$	9.4	14.2	19.4	6.4	23.3				
					$5\text{ V} \pm 0.5\text{ V}$	9.4	14.1	19.3	6.6	23.1				
	$3.3\text{ V} \pm 0.3\text{ V}$	$3.3\text{ V} \pm 0.3\text{ V}$		8.7	13.1	17.8	5.8	21.4						
		$5\text{ V} \pm 0.5\text{ V}$		8.7	13	17.5	6	21.2						
	$t_{dis}$	$\overline{\text{MASTER\_EN}}$		CF output (control)	$\overline{\text{BUF\_EN}} = V_{IL}$	$1.8\text{ V} \pm 0.15\text{ V}$	$3.3\text{ V} \pm 0.3\text{ V}$	7.3	13.8	22.5		6.2	25.8	ns
							$5\text{ V} \pm 0.5\text{ V}$	6.8	12.1	19.7		5.9	26.3	
$2.5\text{ V} \pm 0.2\text{ V}$			$3.3\text{ V} \pm 0.3\text{ V}$			6.1	11.8	19.2	4.9	20.2				
			$5\text{ V} \pm 0.5\text{ V}$			5.9	10	16.3	4.6	19.8				
$3.3\text{ V} \pm 0.3\text{ V}$		$3.3\text{ V} \pm 0.3\text{ V}$	5.6	11		18.3	4.6	19.1						
		$5\text{ V} \pm 0.5\text{ V}$	5.4	9.2		15.5	3.9	18						
$t_{en}$		$\overline{\text{BUF\_EN}}$	CF output (A pins)	$\overline{\text{MASTER\_EN}} = V_{IL}$		$1.8\text{ V} \pm 0.15\text{ V}$	$3.3\text{ V} \pm 0.3\text{ V}$	12.9	17.5	23.7	7.7	29.7	ns	
							$5\text{ V} \pm 0.5\text{ V}$	13.3	17.8	24.4	9.4	30.2		
	$2.5\text{ V} \pm 0.2\text{ V}$				$3.3\text{ V} \pm 0.3\text{ V}$	11.7	14.4	17.9	7.5	23.3				
					$5\text{ V} \pm 0.5\text{ V}$	11.8	14.3	17.1	7.7	23.1				
	$3.3\text{ V} \pm 0.3\text{ V}$	$3.3\text{ V} \pm 0.3\text{ V}$	11		13.3	16.2	6.9	21.4						
		$5\text{ V} \pm 0.5\text{ V}$	11.1		13.2	15.3	6.5	21.2						
	$t_{dis}$	$\overline{\text{BUF\_EN}}$	CF output (A pins)		$\overline{\text{MASTER\_EN}} = V_{IL}$	$1.8\text{ V} \pm 0.15\text{ V}$	$3.3\text{ V} \pm 0.3\text{ V}$	8.9	13.6	19.7	7.5	25.8		ns
							$5\text{ V} \pm 0.5\text{ V}$	7.6	11.8	17.1	6.6	26.3		
$2.5\text{ V} \pm 0.2\text{ V}$				$3.3\text{ V} \pm 0.3\text{ V}$		8	11.6	16	6.6	20.1				
				$5\text{ V} \pm 0.5\text{ V}$		6.7	9.7	13.2	5	19.8				
$3.3\text{ V} \pm 0.3\text{ V}$		$3.3\text{ V} \pm 0.3\text{ V}$	7.7	10.6		14.7	6	18.2						
		$5\text{ V} \pm 0.5\text{ V}$	6.1	8.9		11.9	4.9	18						
$t_{en}$		$\overline{\text{BUF\_EN}}$	CF output (A pins)	$\overline{\text{MASTER\_EN}} = V_{IL}$		$1.8\text{ V} \pm 0.15\text{ V}$	$3.3\text{ V} \pm 0.3\text{ V}$	12.3	16.4	21.9	7.7	27.2	ns	
							$5\text{ V} \pm 0.5\text{ V}$	12.6	16.7	22.6	8.6	29.1		
	$2.5\text{ V} \pm 0.2\text{ V}$				$3.3\text{ V} \pm 0.3\text{ V}$	11.2	13.8	17	7.1	21.7				
					$5\text{ V} \pm 0.5\text{ V}$	11.4	13.7	16.3	7.3	21.5				
	$3.3\text{ V} \pm 0.3\text{ V}$	$3.3\text{ V} \pm 0.3\text{ V}$	10.7		12.9	15.6	6.7	19.5						
		$5\text{ V} \pm 0.5\text{ V}$	10.8		12.8	14.8	6.5	19.6						

**Switching Characteristics (continued)**

 over recommended operating free-air temperature range (SA10–SA00,  $\overline{\text{SCE1}}$ ,  $\overline{\text{SCE2}}$ ,  $\overline{\text{SIORD}}$ ,  $\overline{\text{SIOWR}}$ ,  $\overline{\text{SOE}}$ ,  $\overline{\text{SREG}}$ ,  $\overline{\text{SWE}}$ )  
 (see [Figure 1](#))

PARAMETER	FROM (INPUT)	TO (OUTPUT)	TEST CONDITIONS	$V_{CC\_S}$	$V_{CC\_CF}$	$T_A = 25^\circ\text{C}$			$-40^\circ\text{C to } 85^\circ\text{C}$		UNIT
						MIN	TYP	MAX	MIN	MAX	
$t_{dis}$	$\overline{\text{BUF\_EN}}$	CF output (A pins)	$\overline{\text{MASTER\_EN}} = V_{IL}$	$1.8\text{ V} \pm 0.15\text{ V}$	$3.3\text{ V} \pm 0.3\text{ V}$	8.4	13.9	21.2	7.2	23.2	ns
					$5\text{ V} \pm 0.5\text{ V}$	7.6	12.3	18.5	6.6	23.7	
				$2.5\text{ V} \pm 0.2\text{ V}$	$3.3\text{ V} \pm 0.3\text{ V}$	7.7	12.3	18.2	6.4	19.8	
					$5\text{ V} \pm 0.5\text{ V}$	6.7	10.6	15.3	5	18.4	
				$3.3\text{ V} \pm 0.3\text{ V}$	$3.3\text{ V} \pm 0.3\text{ V}$	7.2	11.5	16.4	5.9	18	
					$5\text{ V} \pm 0.5\text{ V}$	6.4	10	14.3	4.9	17	
$t_{en}$	$\overline{\text{BUF\_EN}}$	CF output	$\overline{\text{MASTER\_EN}} = V_{IL}$	$1.8\text{ V} \pm 0.15\text{ V}$	$3.3\text{ V} \pm 0.3\text{ V}$	12.5	16.6	22.3	8.7	27.2	ns
					$5\text{ V} \pm 0.5\text{ V}$	12.8	17	23.1	8.8	29.1	
				$2.5\text{ V} \pm 0.2\text{ V}$	$3.3\text{ V} \pm 0.3\text{ V}$	11.4	14.1	17.5	7.3	21.7	
					$5\text{ V} \pm 0.5\text{ V}$	11.6	14	16.9	7.4	21.5	
				$3.3\text{ V} \pm 0.3\text{ V}$	$3.3\text{ V} \pm 0.3\text{ V}$	10.9	13.2	16	6.8	20	
					$5\text{ V} \pm 0.5\text{ V}$	11	13.1	15.3	6.5	19.6	
$t_{dis}$	$\overline{\text{BUF\_EN}}$	CF output	$\overline{\text{MASTER\_EN}} = V_{IL}$	$1.8\text{ V} \pm 0.15\text{ V}$	$3.3\text{ V} \pm 0.3\text{ V}$	8.6	13.9	21.5	7.4	23.2	ns
					$5\text{ V} \pm 0.5\text{ V}$	7.7	12.1	19.8	6.6	23.7	
				$2.5\text{ V} \pm 0.2\text{ V}$	$3.3\text{ V} \pm 0.3\text{ V}$	7.9	12.3	18.5	6.5	19.8	
					$5\text{ V} \pm 0.5\text{ V}$	6.6	10.4	17.1	5	18.4	
				$3.3\text{ V} \pm 0.3\text{ V}$	$3.3\text{ V} \pm 0.3\text{ V}$	7.4	11.7	17.5	6.1	18.9	
					$5\text{ V} \pm 0.5\text{ V}$	6.1	9.7	16.2	4.9	17	
$t_{en}$	$\overline{\text{MASTER\_EN}}$	DIR_OUT	$\overline{\text{BUF\_EN}} = V_{IL}$	$1.8\text{ V} \pm 0.15\text{ V}$	$3.3\text{ V} \pm 0.3\text{ V}$	6.1	14.2	29.6	4.9	32.8	ns
					$5\text{ V} \pm 0.5\text{ V}$	6	14.2	30	4.9	33.2	
				$2.5\text{ V} \pm 0.2\text{ V}$	$3.3\text{ V} \pm 0.3\text{ V}$	4.8	8.8	15.4	3.4	19.3	
					$5\text{ V} \pm 0.5\text{ V}$	4.8	8.8	15.5	3.4	19.3	
				$3.3\text{ V} \pm 0.3\text{ V}$	$3.3\text{ V} \pm 0.3\text{ V}$	4.2	6.9	11.1	2.7	14.4	
					$5\text{ V} \pm 0.5\text{ V}$	4.2	6.9	11.1	2.6	14.4	
$t_{dis}$	$\overline{\text{MASTER\_EN}}$	DIR_OUT	$\overline{\text{BUF\_EN}} = V_{IL}$	$1.8\text{ V} \pm 0.15\text{ V}$	$3.3\text{ V} \pm 0.3\text{ V}$	5.4	10	16.6	4.2	32.6	ns
					$5\text{ V} \pm 0.5\text{ V}$	5.4	9.9	16.1	4.8	32.6	
				$2.5\text{ V} \pm 0.2\text{ V}$	$3.3\text{ V} \pm 0.3\text{ V}$	3.9	6.5	10.5	1.5	19.3	
					$5\text{ V} \pm 0.5\text{ V}$	3.9	6.6	10.4	1.7	19.3	
				$3.3\text{ V} \pm 0.3\text{ V}$	$3.3\text{ V} \pm 0.3\text{ V}$	4.4	6.7	10.3	1.4	14.4	
					$5\text{ V} \pm 0.5\text{ V}$	4.3	6.7	10.1	1.5	14.4	
$t_{pd}$	$\overline{\text{SIORD}}$ or $\overline{\text{SOE}}$	DIR_OUT	$\overline{\text{BUF\_EN}} = V_{IL}$	$1.8\text{ V} \pm 0.15\text{ V}$	$3.3\text{ V} \pm 0.3\text{ V}$	5	9.3	15.7	4	17.9	ns
					$5\text{ V} \pm 0.5\text{ V}$	5	9.3	15.7	4	17.9	
				$2.5\text{ V} \pm 0.2\text{ V}$	$3.3\text{ V} \pm 0.3\text{ V}$	3.9	6	8.5	2.8	11	
					$5\text{ V} \pm 0.5\text{ V}$	3.9	6	8.5	2.8	11	
				$3.3\text{ V} \pm 0.3\text{ V}$	$3.3\text{ V} \pm 0.3\text{ V}$	3.3	4.7	6.2	2.2	8.2	
					$5\text{ V} \pm 0.5\text{ V}$	3.3	4.7	6.2	2.2	8.2	
$t_{pd}$	$\overline{\text{BUF\_EN}}$	DIR_OUT	$\overline{\text{BUF\_EN}} = V_{IL}$	$1.8\text{ V} \pm 0.15\text{ V}$	$3.3\text{ V} \pm 0.3\text{ V}$	8.9	19.5	35.9	7.1	39.2	ns
					$5\text{ V} \pm 0.5\text{ V}$	8.9	19.5	35.8	7	39.3	
				$2.5\text{ V} \pm 0.2\text{ V}$	$3.3\text{ V} \pm 0.3\text{ V}$	6.8	11.9	19.1	5	22.8	
					$5\text{ V} \pm 0.5\text{ V}$	6.8	11.9	19.2	4.9	22.8	
				$3.3\text{ V} \pm 0.3\text{ V}$	$3.3\text{ V} \pm 0.3\text{ V}$	5.8	9	13.3	4	15.8	
					$5\text{ V} \pm 0.5\text{ V}$	5.8	9	13.3	3.9	15.9	

## Operating Characteristics

 $V_{CCS}$  and  $V_{CC\_CF} = 3.3\text{ V}$ ,  $T_A = 25^\circ\text{C}$ 

PARAMETER			TEST CONDITIONS	TYP	UNIT
$C_{pdS}$	Power dissipation capacitance per transceiver	System-port input, CF-port output	$C_L = 0$ , $f = 10\text{ MHz}$	1.93	pF
				Outputs enabled	
	CF-port input, system-port output	Outputs enabled		14.35	
		Outputs disabled		0.04	
$C_{pdCF}$	Power dissipation capacitance per transceiver	System-port input, CF-port output	$C_L = 0$ , $f = 10\text{ MHz}$	22.85	pF
				Outputs enabled	
	CF-port input, system-port output	Outputs enabled		4.66	
		Outputs disabled		3.65	

PARAMETER MEASUREMENT INFORMATION

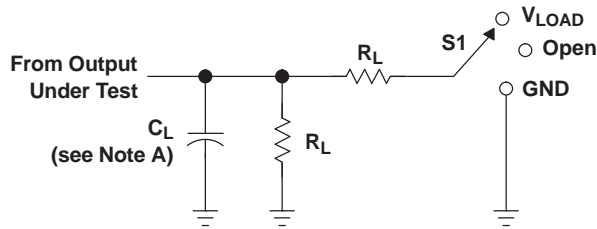

TEST	S1
$t_{pd}$	Open
$t_{PLZ}/t_{PZL}$	$V_{LOAD}$
$t_{PHZ}/t_{PZH}$	GND

LOAD CIRCUIT

$V_{CC}$	INPUT		$V_M$	$V_{LOAD}$	$C_L$	$R_L$	$V_{\Delta}$
	$V_I$	$t_r/t_f$					
$1.8 V \pm 0.15 V$	$V_{CC}$	$\leq 2 ns$	$V_{CC}/2$	$2 \times V_{CC}$	15 pF	2 k $\Omega$	0.15 V
$2.5 \pm 0.2 V$	$V_{CC}$	$\leq 2 ns$	$V_{CC}/2$	$2 \times V_{CC}$	15 pF	2 k $\Omega$	0.15 V
2.7 V	2.7 V	$\leq 2.5 ns$	1.5 V	6 V	15 pF	2 k $\Omega$	0.3 V
$3.3 V \pm 0.3 V$	2.7 V	$\leq 2.5 ns$	1.5 V	6 V	15 pF	2 k $\Omega$	0.3 V
$5.5 V \pm 0.5 V$	2.7 V	$\leq 2.5 ns$	1.5 V	6 V	15 pF	2 k $\Omega$	0.5 V

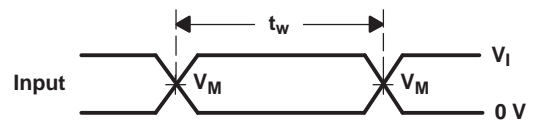
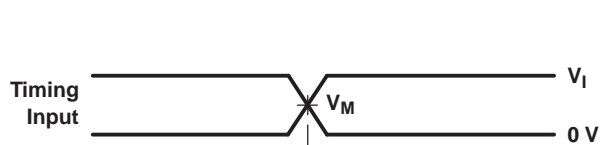

VOLTAGE WAVEFORMS PULSE DURATION

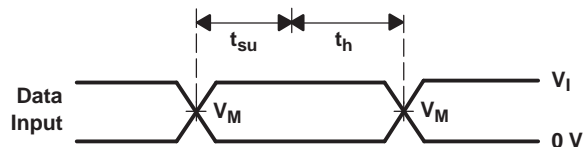

VOLTAGE WAVEFORMS SETUP AND HOLD TIMES

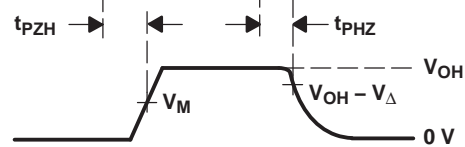
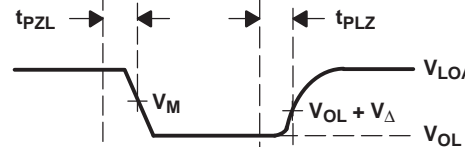
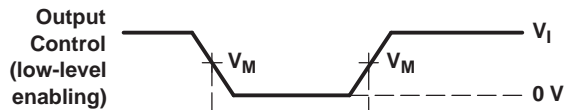

VOLTAGE WAVEFORMS ENABLE AND DISABLE TIMES



VOLTAGE WAVEFORMS PROPAGATION DELAY TIMES

- NOTES:
- A.  $C_L$  includes probe and jig capacitance.
  - B. Waveform 1 is for an output with internal conditions such that the output is low, except when disabled by the output control. Waveform 2 is for an output with internal conditions such that the output is high, except when disabled by the output control.
  - C. All input pulses are supplied by generators having the following characteristics: PRR  $\leq$  10 MHz,  $Z_O = 50 \Omega$ .
  - D. The outputs are measured one at a time, with one transition per measurement.
  - E.  $t_{PLZ}$  and  $t_{PHZ}$  are the same as  $t_{dis}$ .
  - F.  $t_{PZL}$  and  $t_{PZH}$  are the same as  $t_{en}$ .
  - G.  $t_{PLH}$  and  $t_{PHL}$  are the same as  $t_{pd}$ .
  - H. All parameters and waveforms are not applicable to all devices.

Figure 1. Load Circuit and Voltage Waveforms

---

## REVISION HISTORY

Changes from Revision A (August 2006) to Revision B	Page
• Removed Ordering Information table. ....	<a href="#">2</a>

---



**PACKAGING INFORMATION**

Orderable Device	Status (1)	Package Type	Package Drawing	Pins	Package Qty	Eco Plan (2)	Lead/Ball Finish	MSL Peak Temp (3)	Op Temp (°C)	Device Marking (4/5)	Samples
CF4320HZKFR	ACTIVE	LFBGA	ZKF	114	1000	Green (RoHS & no Sb/Br)	SNAGCU	Level-3-260C-168 HR	-40 to 85	CF4320	Samples

(1) The marketing status values are defined as follows:

**ACTIVE:** Product device recommended for new designs.

**LIFEBUY:** TI has announced that the device will be discontinued, and a lifetime-buy period is in effect.

**NRND:** Not recommended for new designs. Device is in production to support existing customers, but TI does not recommend using this part in a new design.

**PREVIEW:** Device has been announced but is not in production. Samples may or may not be available.

**OBSOLETE:** TI has discontinued the production of the device.

(2) Eco Plan - The planned eco-friendly classification: Pb-Free (RoHS), Pb-Free (RoHS Exempt), or Green (RoHS & no Sb/Br) - please check <http://www.ti.com/productcontent> for the latest availability information and additional product content details.

**TBD:** The Pb-Free/Green conversion plan has not been defined.

**Pb-Free (RoHS):** TI's terms "Lead-Free" or "Pb-Free" mean semiconductor products that are compatible with the current RoHS requirements for all 6 substances, including the requirement that lead not exceed 0.1% by weight in homogeneous materials. Where designed to be soldered at high temperatures, TI Pb-Free products are suitable for use in specified lead-free processes.

**Pb-Free (RoHS Exempt):** This component has a RoHS exemption for either 1) lead-based flip-chip solder bumps used between the die and package, or 2) lead-based die adhesive used between the die and leadframe. The component is otherwise considered Pb-Free (RoHS compatible) as defined above.

**Green (RoHS & no Sb/Br):** TI defines "Green" to mean Pb-Free (RoHS compatible), and free of Bromine (Br) and Antimony (Sb) based flame retardants (Br or Sb do not exceed 0.1% by weight in homogeneous material)

(3) MSL, Peak Temp. -- The Moisture Sensitivity Level rating according to the JEDEC industry standard classifications, and peak solder temperature.

(4) There may be additional marking, which relates to the logo, the lot trace code information, or the environmental category on the device.

(5) Multiple Device Markings will be inside parentheses. Only one Device Marking contained in parentheses and separated by a "~" will appear on a device. If a line is indented then it is a continuation of the previous line and the two combined represent the entire Device Marking for that device.

**Important Information and Disclaimer:** The information provided on this page represents TI's knowledge and belief as of the date that it is provided. TI bases its knowledge and belief on information provided by third parties, and makes no representation or warranty as to the accuracy of such information. Efforts are underway to better integrate information from third parties. TI has taken and continues to take reasonable steps to provide representative and accurate information but may not have conducted destructive testing or chemical analysis on incoming materials and chemicals. TI and TI suppliers consider certain information to be proprietary, and thus CAS numbers and other limited information may not be available for release.

In no event shall TI's liability arising out of such information exceed the total purchase price of the TI part(s) at issue in this document sold by TI to Customer on an annual basis.

## TAPE AND REEL INFORMATION



### QUADRANT ASSIGNMENTS FOR PIN 1 ORIENTATION IN TAPE



\*All dimensions are nominal

Device	Package Type	Package Drawing	Pins	SPQ	Reel Diameter (mm)	Reel Width W1 (mm)	A0 (mm)	B0 (mm)	K0 (mm)	P1 (mm)	W (mm)	Pin1 Quadrant
CF4320HZKFR	LFBGA	ZKF	114	1000	330.0	24.4	5.8	16.3	1.8	8.0	24.0	Q1

TAPE AND REEL BOX DIMENSIONS



\*All dimensions are nominal

Device	Package Type	Package Drawing	Pins	SPQ	Length (mm)	Width (mm)	Height (mm)
CF4320HZKFR	LFBGA	ZKF	114	1000	336.6	336.6	41.3

ZKF (R-PBGA-N114)

PLASTIC BALL GRID ARRAY

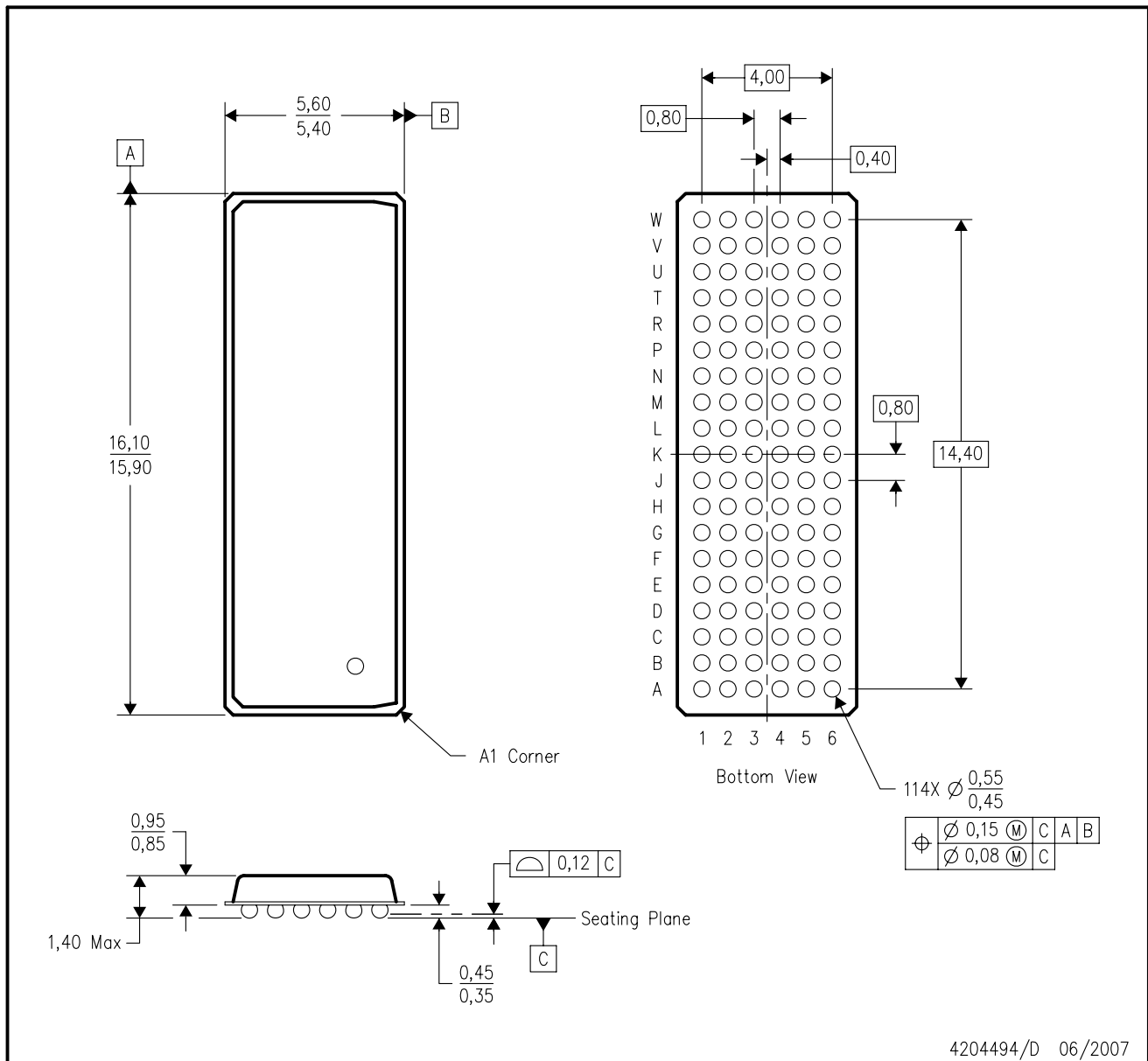

- NOTES:
- A. All linear dimensions are in millimeters. Dimensioning and tolerancing per ASME Y14.5M-1994.
  - B. This drawing is subject to change without notice.
  - C. Falls within JEDEC MO-205 variation DC.
  - D. This package is lead-free. Refer to the 114 GKF package (drawing 4188954) for tin-lead (SnPb).

## IMPORTANT NOTICE

Texas Instruments Incorporated and its subsidiaries (TI) reserve the right to make corrections, enhancements, improvements and other changes to its semiconductor products and services per JESD46, latest issue, and to discontinue any product or service per JESD48, latest issue. Buyers should obtain the latest relevant information before placing orders and should verify that such information is current and complete. All semiconductor products (also referred to herein as "components") are sold subject to TI's terms and conditions of sale supplied at the time of order acknowledgment.

TI warrants performance of its components to the specifications applicable at the time of sale, in accordance with the warranty in TI's terms and conditions of sale of semiconductor products. Testing and other quality control techniques are used to the extent TI deems necessary to support this warranty. Except where mandated by applicable law, testing of all parameters of each component is not necessarily performed.

TI assumes no liability for applications assistance or the design of Buyers' products. Buyers are responsible for their products and applications using TI components. To minimize the risks associated with Buyers' products and applications, Buyers should provide adequate design and operating safeguards.

TI does not warrant or represent that any license, either express or implied, is granted under any patent right, copyright, mask work right, or other intellectual property right relating to any combination, machine, or process in which TI components or services are used. Information published by TI regarding third-party products or services does not constitute a license to use such products or services or a warranty or endorsement thereof. Use of such information may require a license from a third party under the patents or other intellectual property of the third party, or a license from TI under the patents or other intellectual property of TI.

Reproduction of significant portions of TI information in TI data books or data sheets is permissible only if reproduction is without alteration and is accompanied by all associated warranties, conditions, limitations, and notices. TI is not responsible or liable for such altered documentation. Information of third parties may be subject to additional restrictions.

Resale of TI components or services with statements different from or beyond the parameters stated by TI for that component or service voids all express and any implied warranties for the associated TI component or service and is an unfair and deceptive business practice. TI is not responsible or liable for any such statements.

Buyer acknowledges and agrees that it is solely responsible for compliance with all legal, regulatory and safety-related requirements concerning its products, and any use of TI components in its applications, notwithstanding any applications-related information or support that may be provided by TI. Buyer represents and agrees that it has all the necessary expertise to create and implement safeguards which anticipate dangerous consequences of failures, monitor failures and their consequences, lessen the likelihood of failures that might cause harm and take appropriate remedial actions. Buyer will fully indemnify TI and its representatives against any damages arising out of the use of any TI components in safety-critical applications.

In some cases, TI components may be promoted specifically to facilitate safety-related applications. With such components, TI's goal is to help enable customers to design and create their own end-product solutions that meet applicable functional safety standards and requirements. Nonetheless, such components are subject to these terms.

No TI components are authorized for use in FDA Class III (or similar life-critical medical equipment) unless authorized officers of the parties have executed a special agreement specifically governing such use.

Only those TI components which TI has specifically designated as military grade or "enhanced plastic" are designed and intended for use in military/aerospace applications or environments. Buyer acknowledges and agrees that any military or aerospace use of TI components which have **not** been so designated is solely at the Buyer's risk, and that Buyer is solely responsible for compliance with all legal and regulatory requirements in connection with such use.

TI has specifically designated certain components as meeting ISO/TS16949 requirements, mainly for automotive use. In any case of use of non-designated products, TI will not be responsible for any failure to meet ISO/TS16949.

### Products

Audio	<a href="http://www.ti.com/audio">www.ti.com/audio</a>
Amplifiers	<a href="http://amplifier.ti.com">amplifier.ti.com</a>
Data Converters	<a href="http://dataconverter.ti.com">dataconverter.ti.com</a>
DLP® Products	<a href="http://www.dlp.com">www.dlp.com</a>
DSP	<a href="http://dsp.ti.com">dsp.ti.com</a>
Clocks and Timers	<a href="http://www.ti.com/clocks">www.ti.com/clocks</a>
Interface	<a href="http://interface.ti.com">interface.ti.com</a>
Logic	<a href="http://logic.ti.com">logic.ti.com</a>
Power Mgmt	<a href="http://power.ti.com">power.ti.com</a>
Microcontrollers	<a href="http://microcontroller.ti.com">microcontroller.ti.com</a>
RFID	<a href="http://www.ti-rfid.com">www.ti-rfid.com</a>
OMAP Applications Processors	<a href="http://www.ti.com/omap">www.ti.com/omap</a>
Wireless Connectivity	<a href="http://www.ti.com/wirelessconnectivity">www.ti.com/wirelessconnectivity</a>

### Applications

Automotive and Transportation	<a href="http://www.ti.com/automotive">www.ti.com/automotive</a>
Communications and Telecom	<a href="http://www.ti.com/communications">www.ti.com/communications</a>
Computers and Peripherals	<a href="http://www.ti.com/computers">www.ti.com/computers</a>
Consumer Electronics	<a href="http://www.ti.com/consumer-apps">www.ti.com/consumer-apps</a>
Energy and Lighting	<a href="http://www.ti.com/energy">www.ti.com/energy</a>
Industrial	<a href="http://www.ti.com/industrial">www.ti.com/industrial</a>
Medical	<a href="http://www.ti.com/medical">www.ti.com/medical</a>
Security	<a href="http://www.ti.com/security">www.ti.com/security</a>
Space, Avionics and Defense	<a href="http://www.ti.com/space-avionics-defense">www.ti.com/space-avionics-defense</a>
Video and Imaging	<a href="http://www.ti.com/video">www.ti.com/video</a>

### TI E2E Community

[e2e.ti.com](http://e2e.ti.com)