

LM48411 Boomer® Audio Power Amplifier Series Ultra-Low EMI, Filterless, 2.5W, Stereo, Class D Audio Power Amplifier with E²S

Check for Samples: [LM48411](#)

FEATURES

- E²S System Reduces EMI Preserving Audio Quality and Efficiency
- Output Short Circuit Protection
- Stereo Class D Operation
- No Output Filter Required for Inductive Loads
- Logic Selectable Gain
- Independent Shutdown Control
- Minimum External Components
- "Click and Pop" Suppression Circuitry
- Micro-Power Shutdown Mode
- Available in Space-Saving 0.5mm Pitch DSBGA Package

APPLICATIONS

- Mobile Phones
- PDAs
- Portable Electronic Devices

KEY SPECIFICATIONS

- Efficiency at 3.6V, 500mW into 8Ω Speaker: 87% (typ)
- Efficiency at 3.6V, 100mW into 8Ω Speaker: 80% (typ)
- Efficiency at 5V, 1W into 8Ω Speaker: 88% (typ)
- Quiescent Current, 3.6V Supply: 4.2mA (typ)
- Power Output at V_{DD} = 5V R_L = 4Ω, THD ≤ 10%: 2.5W (typ)
- Power Output at V_{DD} = 5V R_L = 8Ω, THD ≤ 10%: 1.5W (typ)
- Total Shutdown Power Supply Current: 0.01μA (typ)
- Single Supply Range: 2.4V to 5.5V

DESCRIPTION

The LM48411 is a single supply, high efficiency, 2.5W/channel Class D audio amplifier. The LM48411 features TI's Enhanced Emissions Suppression (E²S) system, that features a unique patent-pending ultra low EMI, spread spectrum, PWM architecture, that significantly reduces RF emissions while preserving audio quality and efficiency. The E²S system improves battery life, reduces external component count, board area consumption, system cost, and simplifying design.

The LM48411 is designed to meet the demands of mobile phones and other portable communication devices. Operating on a single 5V supply, it is capable of delivering 2.5W/channel of continuous output power to a 4Ω load with less than 10% THD+N. Its flexible power supply requirements allow operation from 2.4V to 5.5V. The wide band spread spectrum architecture of the LM48411 reduces EMI-radiated emissions due to the modulator frequency.

The LM48411 features high efficiency compared to a conventional Class AB amplifier. The E²S system includes an advanced, patent-pending edge rate control (ERC) architecture that further reduce emissions by minimizing the high frequency component of the device output, while maintaining high quality audio reproduction and high efficiency ($\eta = 87\%$ at V_{DD} = 3.6V, P_O = 500mW). Four gain options are pin selectable through GAIN0 and GAIN1 pins.

The LM48411 features a low-power consumption shutdown mode. Shutdown may be enabled by driving the Shutdown pin to a logic low (GND).

Output short circuit protection prevents the device from being damaged during fault conditions. Superior click and pop suppression eliminates audible transients on power up/down and during shutdown. Independent left/right shutdown control maximizes power savings in mixed mono/stereo applications.



Please be aware that an important notice concerning availability, standard warranty, and use in critical applications of Texas Instruments semiconductor products and disclaimers thereto appears at the end of this data sheet.

All trademarks are the property of their respective owners.

LM48411 RF Emissions

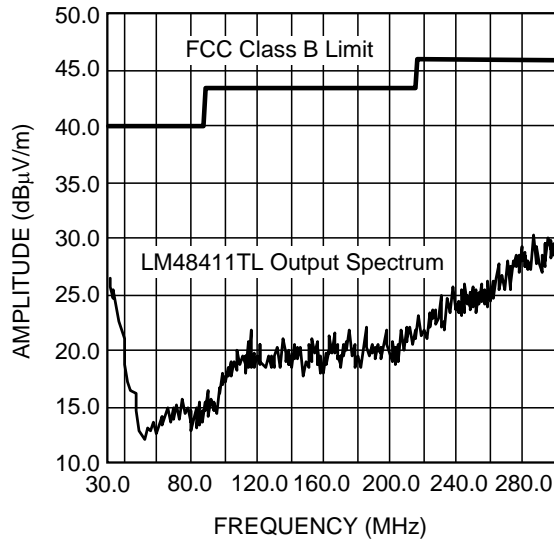

Figure 1. RF Emissions — 3in cable

Typical Application

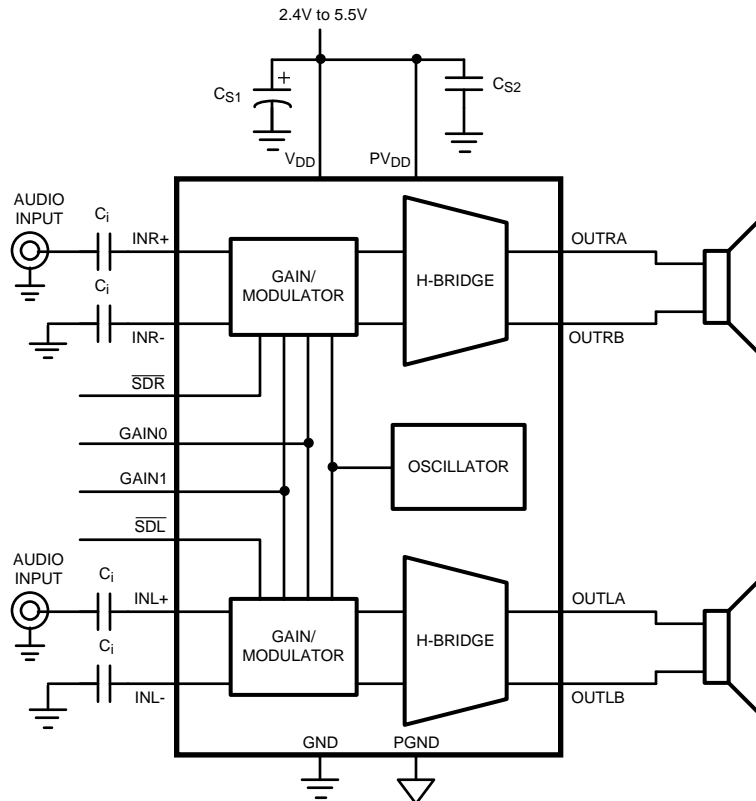

Figure 2. Typical Audio Amplifier Application Circuit

Connection Diagram

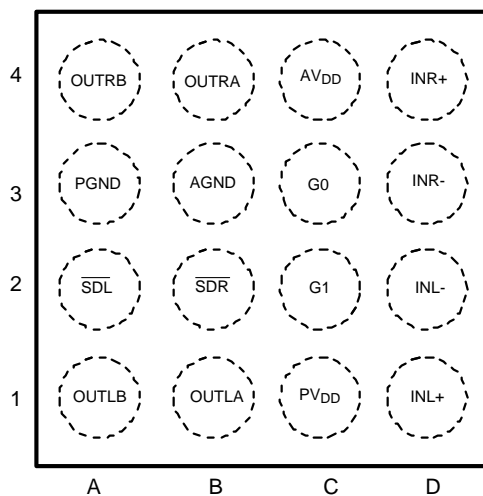

Figure 3. DSBGA - Top View
See YZR0016 Package

PIN DESCRIPTIONS

Bump	Name	Function
A1	OUTLB	Left Channel output B
A2	$\overline{\text{SDL}}$	Left channel active low shutdown
A3	PGND	Power GND
A4	OUTRB	Right channel output B
B1	OUTLA	Left channel output A
B2	$\overline{\text{SDR}}$	Right channel active low shutdown
B3	AGND	Ground
B4	OUTRA	Right channel output A
C1	PV _{DD}	Power V _{DD}
C2	G1	Gain setting input 1
C3	G0	Gain setting input 0
C4	AV _{DD}	Power supply
D1	INL+	Non-inverting left channel input
D2	INL-	Inverting left channel input
D3	INR-	Inverting right channel input
D4	INR+	Non-inverting right channel input



These devices have limited built-in ESD protection. The leads should be shorted together or the device placed in conductive foam during storage or handling to prevent electrostatic damage to the MOS gates.

Absolute Maximum Ratings⁽¹⁾⁽²⁾⁽³⁾

Supply Voltage ⁽¹⁾		6.0V
Storage Temperature		-65°C to +150°C
Voltage at Any Input Pin		$V_{DD} + 0.3V \geq V \geq GND - 0.3V$
Power Dissipation ⁽⁴⁾		Internally Limited
ESD Rating, all other pins ⁽⁵⁾		2.0kV
ESD Rating ⁽⁶⁾		200V
Junction Temperature (T_{JMAX})		150°C
Thermal Resistance	θ_{JA} (DSBGA)	63.6°C/W
Soldering Information	See SNVA009 "microSMD Wafers Level Chip Scale Package."	

- (1) "Absolute Maximum Ratings" indicate limits beyond which damage to the device may occur, including inoperability and degradation of device reliability and/or performance. Functional operation of the device and/or non-degradation at the Absolute *Absolute Maximum Ratings* or other conditions beyond those indicated in the *Recommended Operating Conditions* is not implied. The *Recommended Operating Conditions* indicate conditions at which the device is functional and the device should not be operated beyond such conditions. All voltages are measured with respect to the ground pin, unless otherwise specified
- (2) The *Electrical Characteristics* tables list ensured specifications under the listed *Recommended Operating Conditions* except as otherwise modified or specified by the *Electrical Characteristics Conditions* and/or Notes. Typical specifications are estimations only and are not ensured.
- (3) If Military/Aerospace specified devices are required, please contact the TI Sales Office/ Distributors for availability and specifications.
- (4) The maximum power dissipation must be derated at elevated temperatures and is dictated by T_{JMAX} , θ_{JA} , and the ambient temperature, T_A . The maximum allowable power dissipation is $P_{DMAX} = (T_{JMAX} - T_A) / \theta_{JA}$ or the number given in *Absolute Maximum Ratings*, whichever is lower. For the LMxxxxx, see [Power Derating](#) curves for additional information.
- (5) Human body model, applicable std. JESD22-A114C.
- (6) Machine model, applicable std. JESD22-A115-A.

Operating Ratings⁽¹⁾⁽²⁾

Temperature Range $T_{MIN} \leq T_A \leq T_{MAX}$		$-40^\circ\text{C} \leq T_A \leq 85^\circ\text{C}$
Supply Voltage		$2.4V \leq V_{DD} \leq 5.5V$

- (1) "Absolute Maximum Ratings" indicate limits beyond which damage to the device may occur, including inoperability and degradation of device reliability and/or performance. Functional operation of the device and/or non-degradation at the Absolute *Absolute Maximum Ratings* or other conditions beyond those indicated in the *Recommended Operating Conditions* is not implied. The *Recommended Operating Conditions* indicate conditions at which the device is functional and the device should not be operated beyond such conditions. All voltages are measured with respect to the ground pin, unless otherwise specified
- (2) The *Electrical Characteristics* tables list ensured specifications under the listed *Recommended Operating Conditions* except as otherwise modified or specified by the *Electrical Characteristics Conditions* and/or Notes. Typical specifications are estimations only and are not ensured.

Electrical Characteristics

The following specifications apply for $A_V = 6\text{dB}$, $R_L = 15\mu\text{H}+8\Omega$, $f = 1\text{kHz}$, unless otherwise specified. Limits apply for $T_A = 25^\circ\text{C}$. $V_{DD} = 3.6\text{V}$.

Symbol	Parameter	Conditions	LM48411		Units (Limits)
			Typical ⁽¹⁾	Limit ⁽²⁾⁽³⁾	
$ V_{OS} $	Differential Output Offset Voltage	$V_I = 0\text{V}$, $A_V = 2\text{V/V}$, $V_{DD} = 2.4\text{V to } 5.0\text{V}$	5		mV
I_{DD}	Quiescent Power Supply Current	$V_{IN} = 0\text{V}$, No Load, $V_{DD} = 5.0\text{V}$	5.1	7.5	mA (max)
		$V_{IN} = 0\text{V}$, No Load, $V_{DD} = 3.6\text{V}$	4.2	6.0	mA (max)
		$V_{IN} = 0\text{V}$, No Load, $V_{DD} = 2.4\text{V}$	3.0	4.5	mA (max)
		$V_{IN} = 0\text{V}$, $R_L = 8\Omega$, $V_{DD} = 5.0\text{V}$	5.2		mA
		$V_{IN} = 0\text{V}$, $R_L = 8\Omega$, $V_{DD} = 3.6\text{V}$	4.2		mA
		$V_{IN} = 0\text{V}$, $R_L = 8\Omega$, $V_{DD} = 2.4\text{V}$	3.0		mA
I_{SD}	Shutdown Current ⁽³⁾	$V_{SDR} = V_{SDL} = \text{GND}$	0.01	1.0	μA (max)
V_{SDIH}	Shutdown voltage input high	For SDR, SDL		1.4	V (min)
V_{SDIL}	Shutdown voltage input low	For SDR, SDL		0.4	V (max)
A_V	Gain	$\text{GAIN}_0, \text{GAIN}_1 = \text{GND}$ $R_L = \infty$	6	6 ± 0.5	dB
		$\text{GAIN}_0 = V_{DD}, \text{GAIN}_1 = \text{GND}$ $R_L = \infty$	12	12 ± 0.5	dB
		$\text{GAIN}_0 = \text{GND}, \text{GAIN}_1 = V_{DD}$ $R_L = \infty$	18	18 ± 0.5	dB
		$\text{GAIN}_0, \text{GAIN}_1 = V_{DD}$ $R_L = \infty$	24	24 ± 0.5	dB
R_{IN}	Input Resistance	$A_V = 6\text{dB}$	56		k Ω
		$A_V = 12\text{dB}$	37.5		k Ω
		$A_V = 18\text{dB}$	22.5		k Ω
		$A_V = 24\text{dB}$	12.5		k Ω
T_{WU}	Wake Up Time	$\sqrt{V_{SDR}/V_{SDL}} = 0.4\text{V}$	4.2		ms

(1) Typical values represent most likely parametric norms at $T_A = +25^\circ\text{C}$, and at the *Recommended Operation Conditions* at the time of product characterization and are not specified.

(2) Datasheet min/max specification limits are not specified by test or statistical analysis.

(3) Shutdown current is measured in a normal room environment. Exposure to direct sunlight will increase I_{SD} by a maximum of $2\mu\text{A}$. The Shutdown pin should be driven as close as possible to GND for minimal shutdown current and to V_{DD} for the best THD performance in PLAY mode. See the [Application Information](#) section under [SHUTDOWN FUNCTION](#) for more information.

Electrical Characteristics (continued)

The following specifications apply for $A_V = 6\text{dB}$, $R_L = 15\mu\text{H} + 8\Omega$, $f = 1\text{kHz}$, unless otherwise specified. Limits apply for $T_A = 25^\circ\text{C}$. $V_{DD} = 3.6\text{V}$.

Symbol	Parameter	Conditions	LM48411		Units (Limits)
			Typical ⁽¹⁾	Limit ⁽²⁾⁽³⁾	
P_O	Output Power	$R_L = 15\mu\text{H} + 4\Omega + 15\mu\text{H}$ THD = 10% (max) $f = 1\text{kHz}$, 22kHz BW			
		$V_{DD} = 5\text{V}$	2.5		W
		$V_{DD} = 3.6\text{V}$	1.2		W
		$V_{DD} = 2.5\text{V}$	530		mW
		$R_L = 15\mu\text{H} + 4\Omega + 15\mu\text{H}$ THD = 1% (max) $f = 1\text{kHz}$, 22kHz BW			
		$V_{DD} = 5\text{V}$	2		W
		$V_{DD} = 3.6\text{V}$	1		W
		$V_{DD} = 2.5\text{V}$	430		mW
		$R_L = 15\mu\text{H} + 8\Omega + 15\mu\text{H}$ THD = 10% (max) $f = 1\text{kHz}$, 22kHz BW			
		$V_{DD} = 5\text{V}$	1.5		W
		$V_{DD} = 3.6\text{V}$	760		mW
		$V_{DD} = 2.5\text{V}$	330		mW
		$R_L = 15\mu\text{H} + 8\Omega + 15\mu\text{H}$ THD = 1% (max) $f = 1\text{kHz}$, 22kHz BW			
		$V_{DD} = 5\text{V}$	1.25		W
		$V_{DD} = 3.6\text{V}$	615		mW
$V_{DD} = 2.5\text{V}$	270		mW		
THD+N	Total Harmonic Distortion + Noise	$P_O = 500\text{mW}$, $f = 1\text{kHz}$, $R_L = 8\Omega$	0.05		%
		$P_O = 300\text{mW}$, $f = 1\text{kHz}$, $R_L = 8\Omega$	0.03		%
PSRR	Power Supply Rejection Ratio (Input Referred)	$V_{\text{Ripple}} = 200\text{mV}_{\text{PP}}$ Sine, $f_{\text{Ripple}} = 217\text{Hz}$, $V_{DD} = 3.6, 5\text{V}$ Inputs to AC GND, $C_I = 2\mu\text{F}$	78		dB
		$V_{\text{Ripple}} = 200\text{mV}_{\text{PP}}$ Sine, $f_{\text{Ripple}} = 1\text{kHz}$, $V_{DD} = 3.6, 5\text{V}$ Inputs to AC GND, $C_I = 2\mu\text{F}$	77		dB
SNR	Signal to Noise Ratio	$V_{DD} = 5\text{V}$, $P_{O_{\text{RMS}}} = 1\text{W}$	96		dB
ϵ_{OUT}	Output Noise (Input Referred)	$V_{DD} = 3.6\text{V}$, A Weighted	22		μV_{RMS}
CMRR	Common Mode Rejection Ratio (Input Referred)	$V_{DD} = 3.6\text{V}$, $V_{\text{Ripple}} = 1\text{V}_{\text{PP}}$ Sine $f_{\text{Ripple}} = 217\text{Hz}$	64		dB
η	Efficiency	$V_{DD} = 5\text{V}$, $P_{\text{OUT}} = 1\text{W}$ $R_L = 8\Omega$	88		%
Xtalk	Crosstalk	$P_O = 500\text{mW}$, $f = \text{kHz}$	84		dB

Typical Performance Characteristics

The performance graphs were taken using the Audio Precision AUX-0025 Switching Amplifier measurement Filter in series with the LC filter on the demo board.

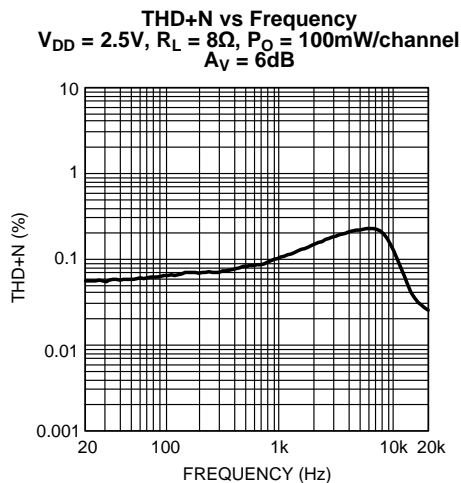

Figure 4.

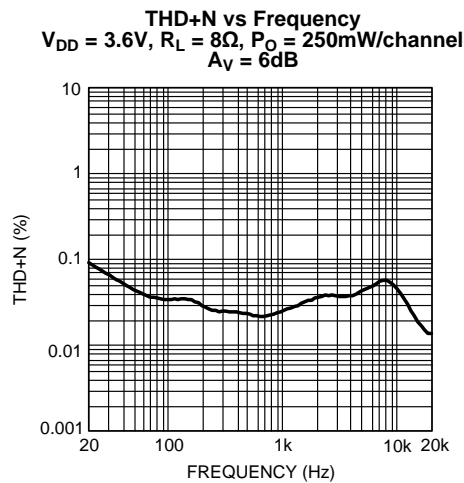

Figure 5.

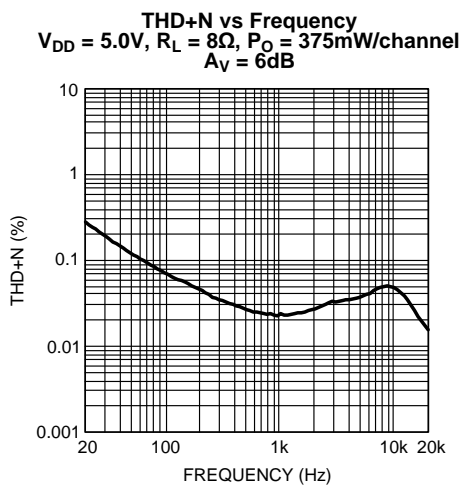

Figure 6.

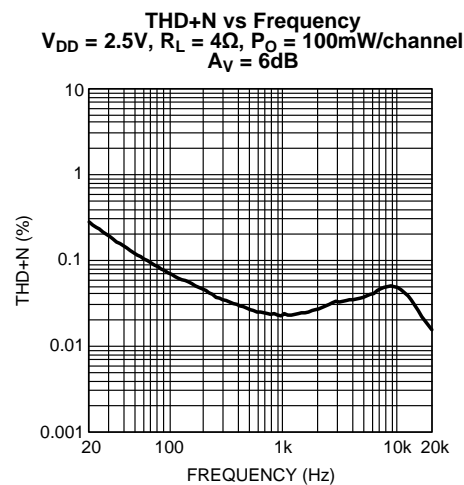

Figure 7.

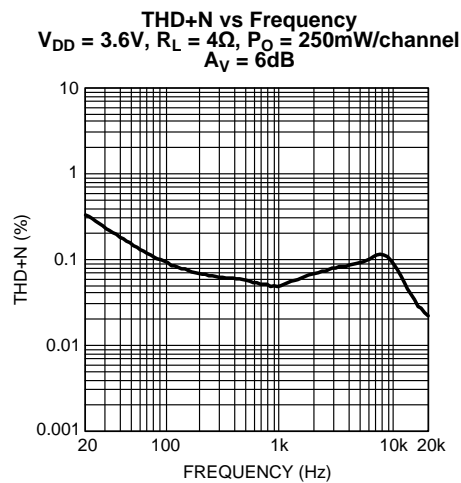

Figure 8.

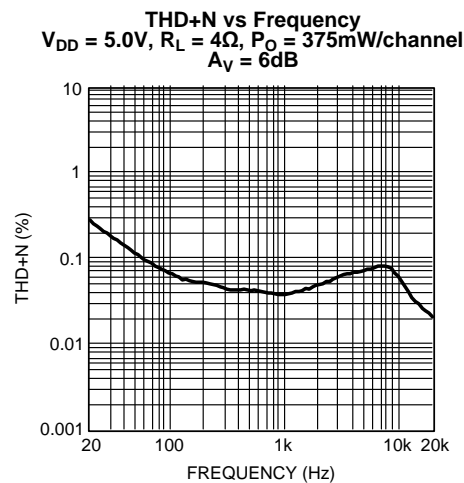

Figure 9.

Typical Performance Characteristics (continued)

The performance graphs were taken using the Audio Precision AUX-0025 Switching Amplifier measurement Filter in series with the LC filter on the demo board.

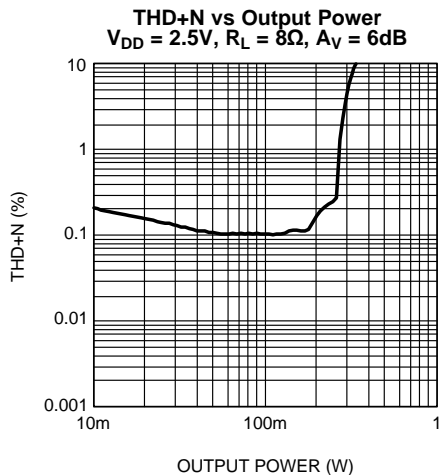

Figure 10.

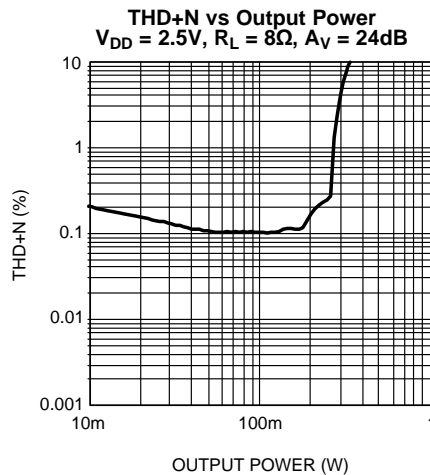

Figure 11.

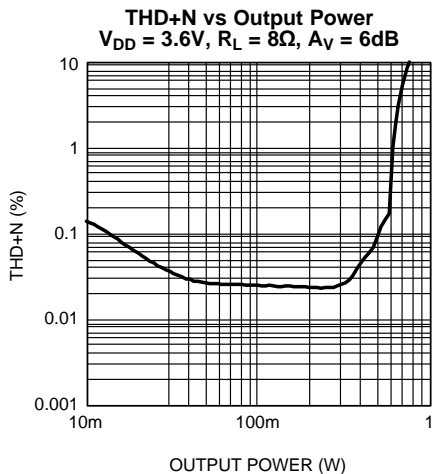

Figure 12.

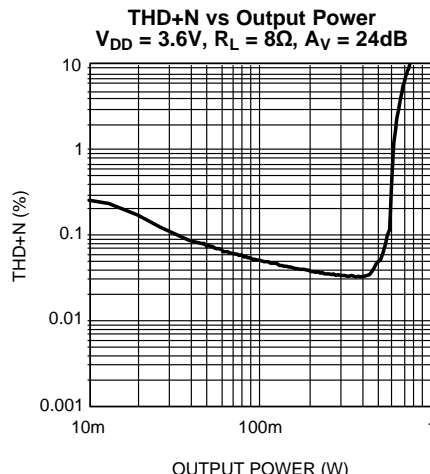

Figure 13.

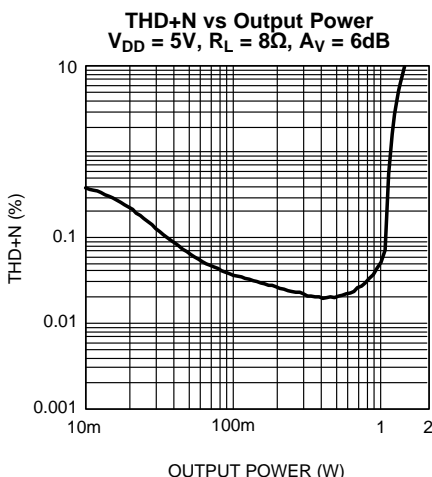

Figure 14.

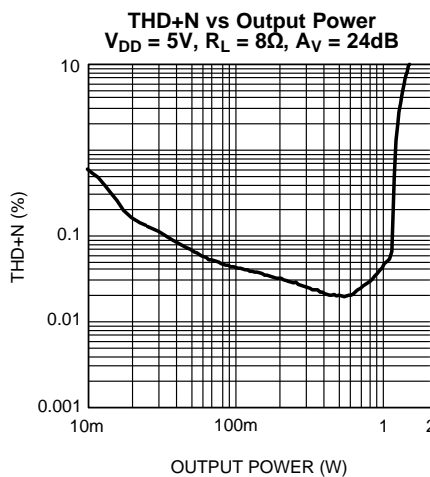

Figure 15.

Typical Performance Characteristics (continued)

The performance graphs were taken using the Audio Precision AUX-0025 Switching Amplifier measurement Filter in series with the LC filter on the demo board.

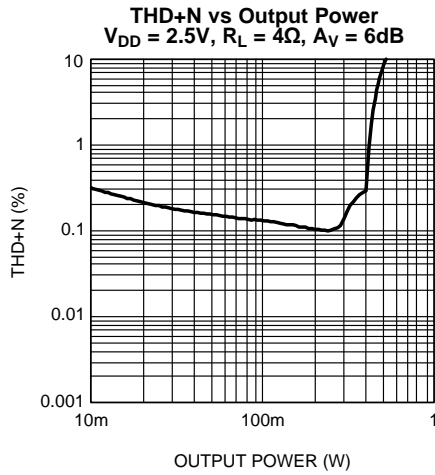

Figure 16.

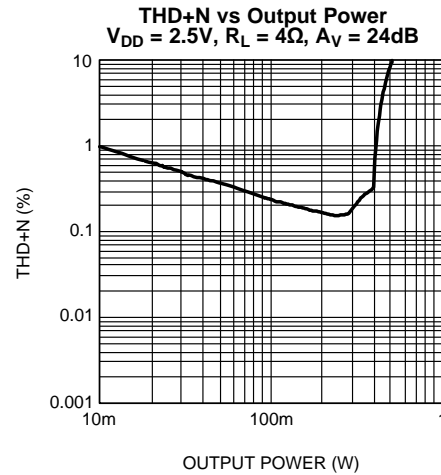

Figure 17.

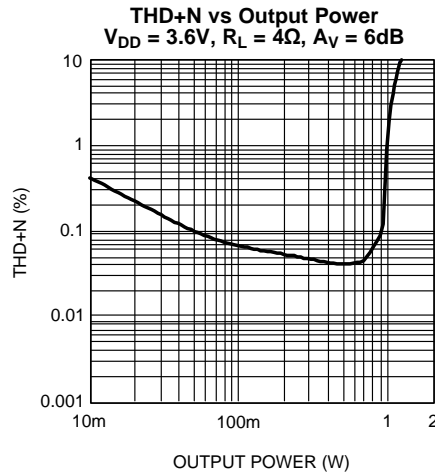

Figure 18.

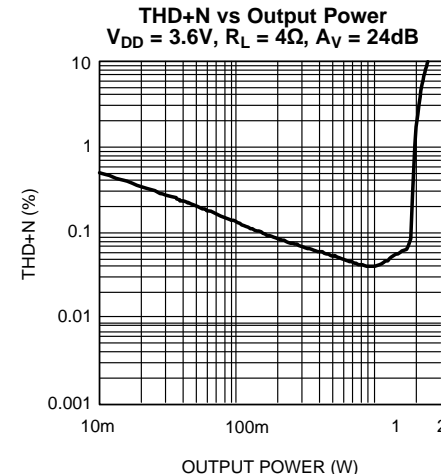

Figure 19.

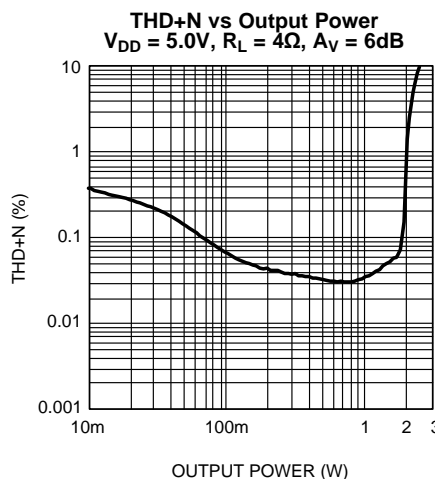

Figure 20.

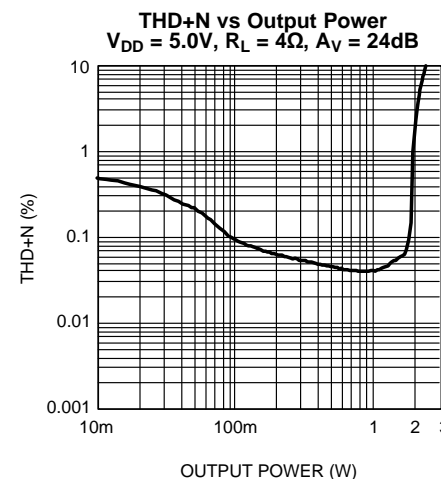

Figure 21.

Typical Performance Characteristics (continued)

The performance graphs were taken using the Audio Precision AUX-0025 Switching Amplifier measurement Filter in series with the LC filter on the demo board.

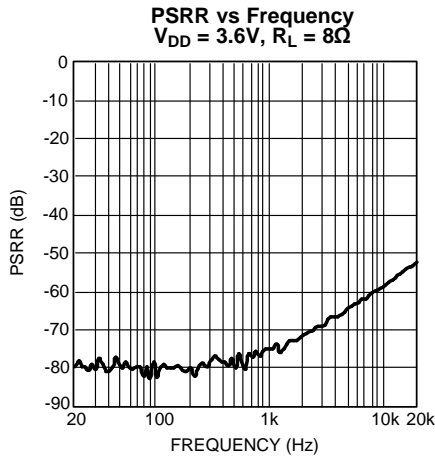

Figure 22.

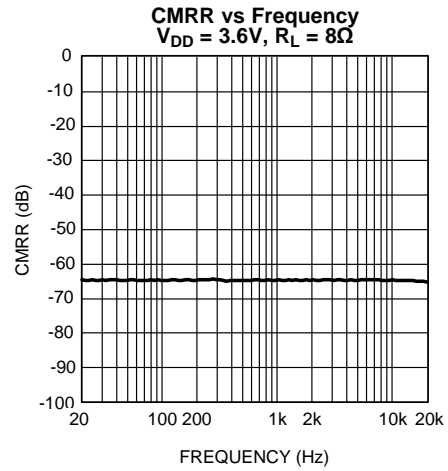

Figure 23.

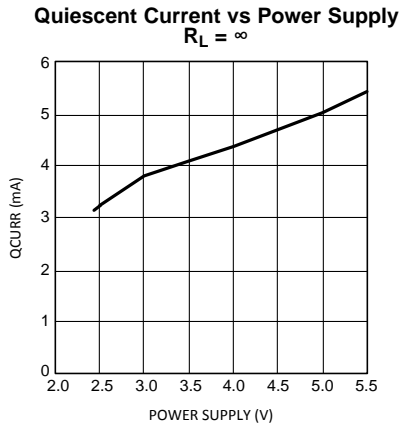

Figure 24.

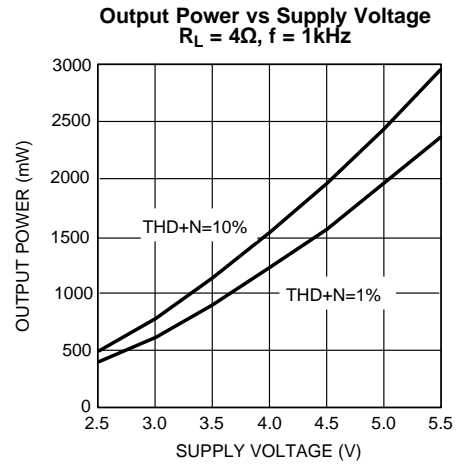

Figure 25.

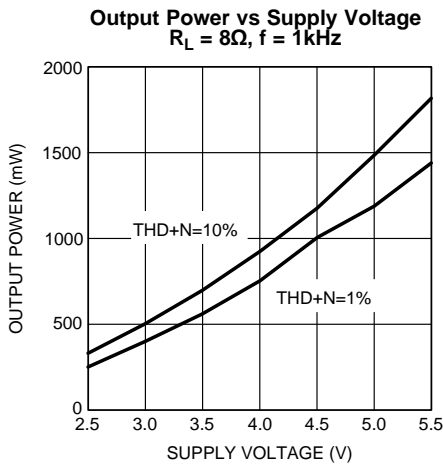

Figure 26.

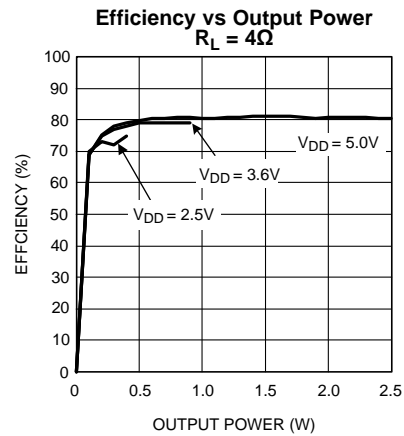

Figure 27.

Typical Performance Characteristics (continued)

The performance graphs were taken using the Audio Precision AUX-0025 Switching Amplifier measurement Filter in series with the LC filter on the demo board.

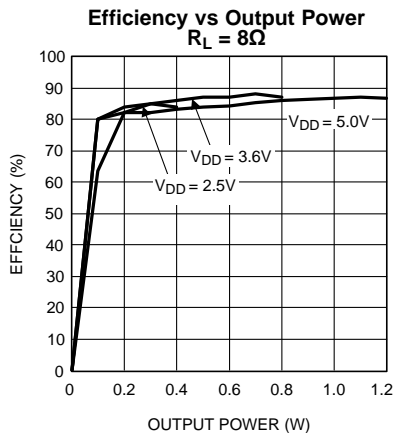

Figure 28.

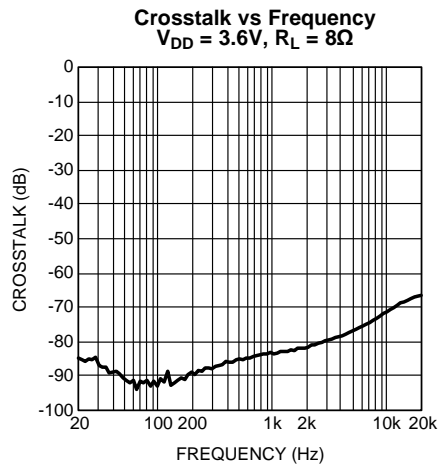

Figure 29.

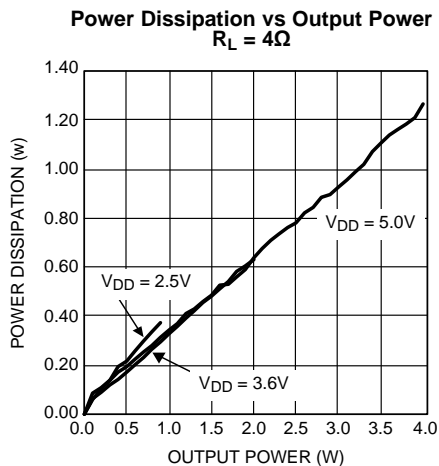

Figure 30.

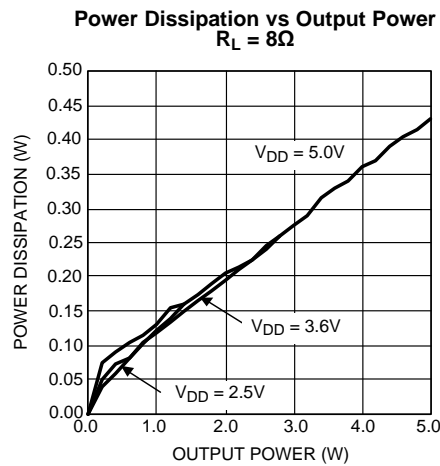

Figure 31.

External Components Description

(Figure 2)

Components		Functional Description
1.	C_S	Supply bypass capacitor which provides power supply filtering. Refer to the Power Supply Bypassing section for information concerning proper placement and selection of the supply bypass capacitor.
2.	C_I	Input AC coupling capacitor which blocks the DC voltage at the amplifier's input terminals.

APPLICATION INFORMATION

GENERAL AMPLIFIER FUNCTION

The LM48411 features a filterless modulation scheme. The differential outputs of the device switch at 300kHz from V_{DD} to GND. When there is no input signal applied, the two outputs (V_{O1} and V_{O2}) switch with a 50% duty cycle, with both outputs in phase. Because the outputs of the LM48411 are differential, the two signals cancel each other. This results in no net voltage across the speaker, thus there is no load current during an idle state, conserving power.

With an input signal applied, the duty cycle (pulse width) of the LM48411 outputs changes. For increasing output voltages, the duty cycle of V_{O1} increases, while the duty cycle of V_{O2} decreases. For decreasing output voltages, the converse occurs, the duty cycle of V_{O2} increases while the duty cycle of V_{O1} decreases. The difference between the two pulse widths yields the differential output voltage.

SPREAD SPECTRUM MODULATION

The LM48411 features a filterless spread spectrum modulation scheme that eliminates the need for output filters, ferrite beads or chokes. The switching frequency varies by $\pm 30\%$ about a 300kHz center frequency, reducing the wideband spectral content, improving EMI emissions radiated by the speaker and associated cables and traces. Where a fixed frequency class D exhibits large amounts of spectral energy at multiples of the switching frequency, the spread spectrum architecture of the LM48411 spreads that energy over a larger bandwidth. The cycle-to-cycle variation of the switching period does not affect the audio reproduction of efficiency.

ENHANCED EMISSIONS SUPPRESSION SYSTEM (E²S)

The LM48411 features TI's patent-pending E²S system that reduces EMI, while maintaining high quality audio reproduction and efficiency. The E²S system features a synchronizable oscillator with selectable spread spectrum, and advanced edge rate control (ERC). The LM48411 ERC greatly reduces the high frequency components of the output square waves by controlling the output rise and fall times, slowing the transitions to reduce RF emissions, while maximizing THD+N and efficiency performance.

POWER DISSIPATION AND EFFICIENCY

In general terms, efficiency is considered to be the ratio of useful work output divided by the total energy required to produce it with the difference being the power dissipated, typically, in the IC. The key here is "useful" work. For audio systems, the energy delivered in the audible bands is considered useful including the distortion products of the input signal. Sub-sonic (DC) and super-sonic components (>22kHz) are not useful. The difference between the power flowing from the power supply and the audio band power being transduced is dissipated in the LM48411 and in the transducer load. The amount of power dissipation in the LM48411 is very low. This is because the ON resistance of the switches used to form the output waveforms is typically less than 0.25Ω . This leaves only the transducer load as a potential "sink" for the small excess of input power over audio band output power. The LM48411 dissipates only a fraction of the excess power requiring no additional PCB area or copper plane to act as a heat sink.

DIFFERENTIAL AMPLIFIER EXPLANATION

As logic supply voltages continue to shrink, designers are increasingly turning to differential analog signal handling to preserve signal to noise ratios with restricted voltage swing. The LM48411 is a fully differential amplifier that features differential input and output stages. A differential amplifier amplifies the difference between the two input signals. Traditional audio power amplifiers have typically offered only single-ended inputs resulting in a 6dB reduction in signal to noise ratio relative to differential inputs. The LM48411 also offers the possibility of

DC input coupling which eliminates the two external AC coupling, DC blocking capacitors. The LM48411 can be used, however, as a single ended input amplifier while still retaining its fully differential benefits. In fact, completely unrelated signals may be placed on the input pins. The LM48411 simply amplifies the difference between the signals. A major benefit of a differential amplifier is the improved common mode rejection ratio (CMRR) over single input amplifiers. The common-mode rejection characteristic of the differential amplifier reduces sensitivity to ground offset related noise injection, especially important in high noise applications.

PCB LAYOUT CONSIDERATIONS

As output power increases, interconnect resistance (PCB traces and wires) between the amplifier, load and power supply create a voltage drop. The voltage loss on the traces between the LM48411 and the load results in lower output power and decreased efficiency. Higher trace resistance between the supply and the LM48411 has the same effect as a poorly regulated supply, increased ripple on the supply line also reducing the peak output power. The effects of residual trace resistance increases as output current increases due to higher output power, decreased load impedance or both. To maintain the highest output voltage swing and corresponding peak output power, the PCB traces that connect the output pins to the load and the supply pins to the power supply should be as wide as possible to minimize trace resistance.

The use of power and ground planes will give the best THD+N performance. While reducing trace resistance, the use of power planes also creates parasitic capacitors that help to filter the power supply line.

The inductive nature of the transducer load can also result in overshoot on one or both edges, clamped by the parasitic diodes to GND and V_{DD} in each case. From an EMI standpoint, this is an aggressive waveform that can radiate or conduct to other components in the system and cause interference. It is essential to keep the power and output traces short and well shielded if possible. Use of ground planes, beads, and micro-strip layout techniques are all useful in preventing unwanted interference.

As the distance from the LM48411 and the speaker increase, the amount of EMI radiation will increase since the output wires or traces acting as antenna become more efficient with length. What is acceptable EMI is highly application specific. Ferrite chip inductors placed close to the LM48411 may be needed to reduce EMI radiation. The value of the ferrite chip is very application specific.

SHUTDOWN FUNCTION

In order to reduce power consumption while not in use, the LM48411 contains shutdown circuitry that reduces current draw to less than 0.01 μ A. The trigger point for shutdown is shown as a typical value in the Electrical Characteristics Tables and in the Shutdown Hysteresis Voltage graphs found in the [Typical Performance Characteristics](#) section. It is best to switch between ground and supply for minimum current usage while in the shutdown state. While the LM48411 may be disabled with shutdown voltages in between ground and supply, the idle current will be greater than the typical 0.01 μ A value.

The LM48411 has an internal resistor connected between GND and Shutdown pins. The purpose of this resistor is to eliminate any unwanted state changes when the Shutdown pin is floating. The LM48411 will enter the shutdown state when the Shutdown pin is left floating or if not floating, when the shutdown voltage has crossed the threshold. To minimize the supply current while in the shutdown state, the Shutdown pin should be driven to GND or left floating. If the Shutdown pin is not driven to GND, the amount of additional resistor current due to the internal shutdown resistor can be found by [Equation 1](#) below.

$$(V_{SD} - GND) / 300k\Omega \quad (1)$$

With only a 0.5V difference, an additional 1.7 μ A of current will be drawn while in the shutdown state.

AUDIO AMPLIFIER POWER SUPPLY BYPASSING FILTERING

Proper power supply bypassing is critical for low noise performance and high PSRR. Place the supply bypass capacitor as close to the device as possible. Typical applications employ a voltage regulator with 10 μ F and 0.1 μ F bypass capacitors that increase supply stability. These capacitors do not eliminate the need for bypassing of the LM48411 supply pins. A 1 μ F capacitor is recommended.

AUDIO AMPLIFIER INPUT CAPACITOR SELECTION

Input capacitors may be required for some applications, or when the audio source is single-ended. Input capacitors block the DC component of the audio signal, eliminating any conflict between the DC component of the audio source and the bias voltage of the LM48411. The input capacitors create a high-pass filter with the input resistance R_i . The -3dB point of the high pass filter is found using [Equation 2](#) below.

$$f = 1 / 2\pi R_i C_i \quad (2)$$

The values for R_i can be found in the EC table for each gain setting.

The input capacitors can also be used to remove low frequency content from the audio signal. Small speakers cannot reproduce, and may even be damaged by low frequencies. High pass filtering the audio signal helps protect the speakers. When the LM48411 is using a single-ended source, power supply noise on the ground is seen as an input signal. Setting the high-pass filter point above the power supply noise frequencies, 217 Hz in a GSM phone, for example, filters out the noise such that it is not amplified and heard on the output. Capacitors with a tolerance of 10% or better are recommended for impedance matching and improved CMRR and PSRR.

AUDIO AMPLIFIER GAIN SETTING

The LM48411 features four internally configured gain settings. The device gain is selected through the two logic inputs, G0 and G1. The gain settings are as shown in the following table.

LOGIC INPUT		GAIN	
G1	G0	V/V	dB
0	0	2	6
0	1	4	12
1	0	8	18
1	1	16	24

Build of Materials

Designator	Description	Footprint	Quantity
C1, C2	Ceramic Capacitor 0.1 μ F, 50V, 10%	805	2
C3 – C6	Tantalum Capacitors 1 μ F 20V, 10%, Size A	1206	4
C11	Tantalum Capacitors 10 μ F 20V, 10% Size B	1411	1
JP1–5, JP8–11	Jumper Header Vertical Mount 2X1 0.100		9
JP6, JP7	Jumper Header Vertical Mount 3x1 0.100		2

Demonstration Board Schematic

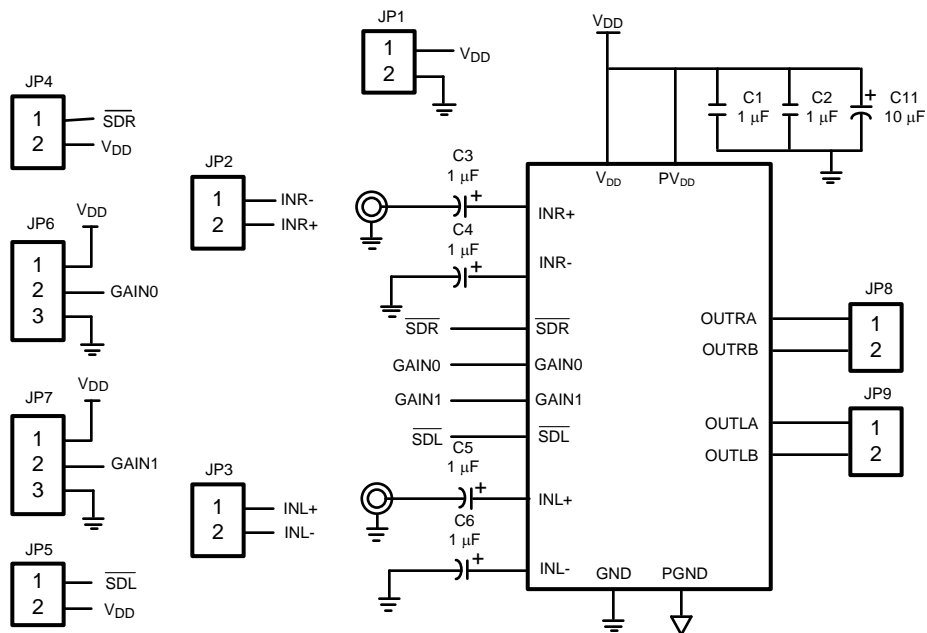

Demonstration Board Layout

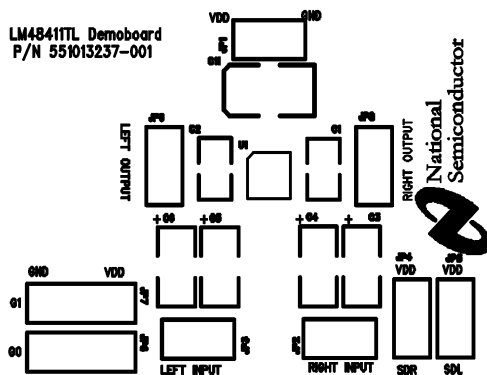

Figure 32. Top Silkscreen Layer

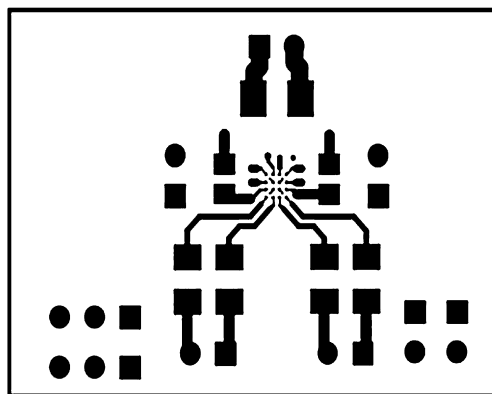

Figure 33. Top Layer

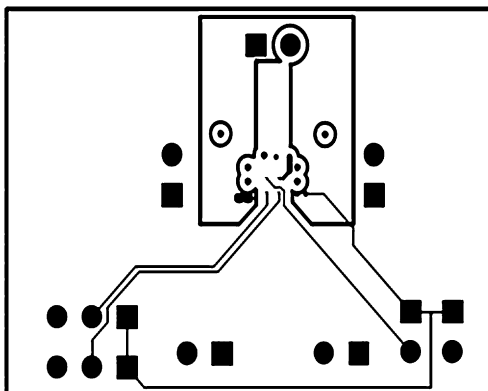

Figure 34. Mid 1 Layer

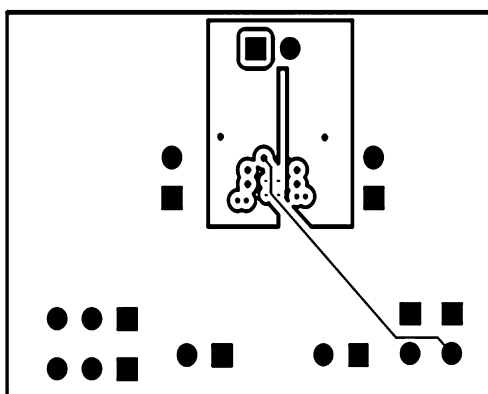

Figure 35. Mid 2 Layer

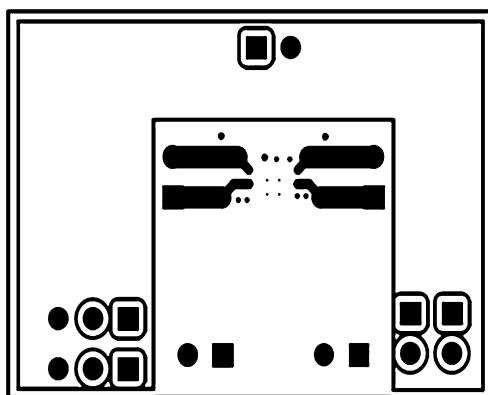

Figure 36. Bottom Layer

REVISION HISTORY

Rev	Date	Description
1.0	09/21/07	Initial release.
1.1	10/01/07	Fixed few typos.
1.2	11/30/07	Added the demo boards and BOM.
1.3	12/19/07	Edited the 16–bump DSBGA package diagram and the Pin Description table.
1.4	01/08/08	Edited the 16–bump DSBGA package diagram.
1.5	06/27/08	Text edits.
1.6	07/03/08	Text edits (under SHUTDOWN FUNCTION).

Changes from Revision F (May 2013) to Revision G
Page

- | | |
|--|-----------|
| <ul style="list-style-type: none"> • Changed layout of National Data Sheet to TI format | 16 |
|--|-----------|

PACKAGING INFORMATION

Orderable Device	Status (1)	Package Type	Package Drawing	Pins	Package Qty	Eco Plan (2)	Lead/Ball Finish	MSL Peak Temp (3)	Op Temp (°C)	Top-Side Markings (4)	Samples
LM48411TL/NOPB	ACTIVE	DSBGA	YZR	16	250	Green (RoHS & no Sb/Br)	SNAGCU	Level-1-260C-UNLIM	-40 to 85	GJ2	Samples
LM48411TLX/NOPB	ACTIVE	DSBGA	YZR	16	3000	Green (RoHS & no Sb/Br)	SNAGCU	Level-1-260C-UNLIM	-40 to 85	GJ2	Samples

(1) The marketing status values are defined as follows:

ACTIVE: Product device recommended for new designs.

LIFEBUY: TI has announced that the device will be discontinued, and a lifetime-buy period is in effect.

NRND: Not recommended for new designs. Device is in production to support existing customers, but TI does not recommend using this part in a new design.

PREVIEW: Device has been announced but is not in production. Samples may or may not be available.

OBSOLETE: TI has discontinued the production of the device.

(2) Eco Plan - The planned eco-friendly classification: Pb-Free (RoHS), Pb-Free (RoHS Exempt), or Green (RoHS & no Sb/Br) - please check <http://www.ti.com/productcontent> for the latest availability information and additional product content details.

TBD: The Pb-Free/Green conversion plan has not been defined.

Pb-Free (RoHS): TI's terms "Lead-Free" or "Pb-Free" mean semiconductor products that are compatible with the current RoHS requirements for all 6 substances, including the requirement that lead not exceed 0.1% by weight in homogeneous materials. Where designed to be soldered at high temperatures, TI Pb-Free products are suitable for use in specified lead-free processes.

Pb-Free (RoHS Exempt): This component has a RoHS exemption for either 1) lead-based flip-chip solder bumps used between the die and package, or 2) lead-based die adhesive used between the die and leadframe. The component is otherwise considered Pb-Free (RoHS compatible) as defined above.

Green (RoHS & no Sb/Br): TI defines "Green" to mean Pb-Free (RoHS compatible), and free of Bromine (Br) and Antimony (Sb) based flame retardants (Br or Sb do not exceed 0.1% by weight in homogeneous material)

(3) MSL, Peak Temp. -- The Moisture Sensitivity Level rating according to the JEDEC industry standard classifications, and peak solder temperature.

(4) Multiple Top-Side Markings will be inside parentheses. Only one Top-Side Marking contained in parentheses and separated by a "~" will appear on a device. If a line is indented then it is a continuation of the previous line and the two combined represent the entire Top-Side Marking for that device.

Important Information and Disclaimer: The information provided on this page represents TI's knowledge and belief as of the date that it is provided. TI bases its knowledge and belief on information provided by third parties, and makes no representation or warranty as to the accuracy of such information. Efforts are underway to better integrate information from third parties. TI has taken and continues to take reasonable steps to provide representative and accurate information but may not have conducted destructive testing or chemical analysis on incoming materials and chemicals. TI and TI suppliers consider certain information to be proprietary, and thus CAS numbers and other limited information may not be available for release.

In no event shall TI's liability arising out of such information exceed the total purchase price of the TI part(s) at issue in this document sold by TI to Customer on an annual basis.

TAPE AND REEL INFORMATION



QUADRANT ASSIGNMENTS FOR PIN 1 ORIENTATION IN TAPE



*All dimensions are nominal

Device	Package Type	Package Drawing	Pins	SPQ	Reel Diameter (mm)	Reel Width W1 (mm)	A0 (mm)	B0 (mm)	K0 (mm)	P1 (mm)	W (mm)	Pin1 Quadrant
LM48411TL/NOPB	DSBGA	YZR	16	250	178.0	8.4	2.18	2.18	0.76	4.0	8.0	Q1
LM48411TLX/NOPB	DSBGA	YZR	16	3000	178.0	8.4	2.18	2.18	0.76	4.0	8.0	Q1

TAPE AND REEL BOX DIMENSIONS

*All dimensions are nominal

Device	Package Type	Package Drawing	Pins	SPQ	Length (mm)	Width (mm)	Height (mm)
LM48411TL/NOPB	DSBGA	YZR	16	250	210.0	185.0	35.0
LM48411TLX/NOPB	DSBGA	YZR	16	3000	210.0	185.0	35.0

YZR0016

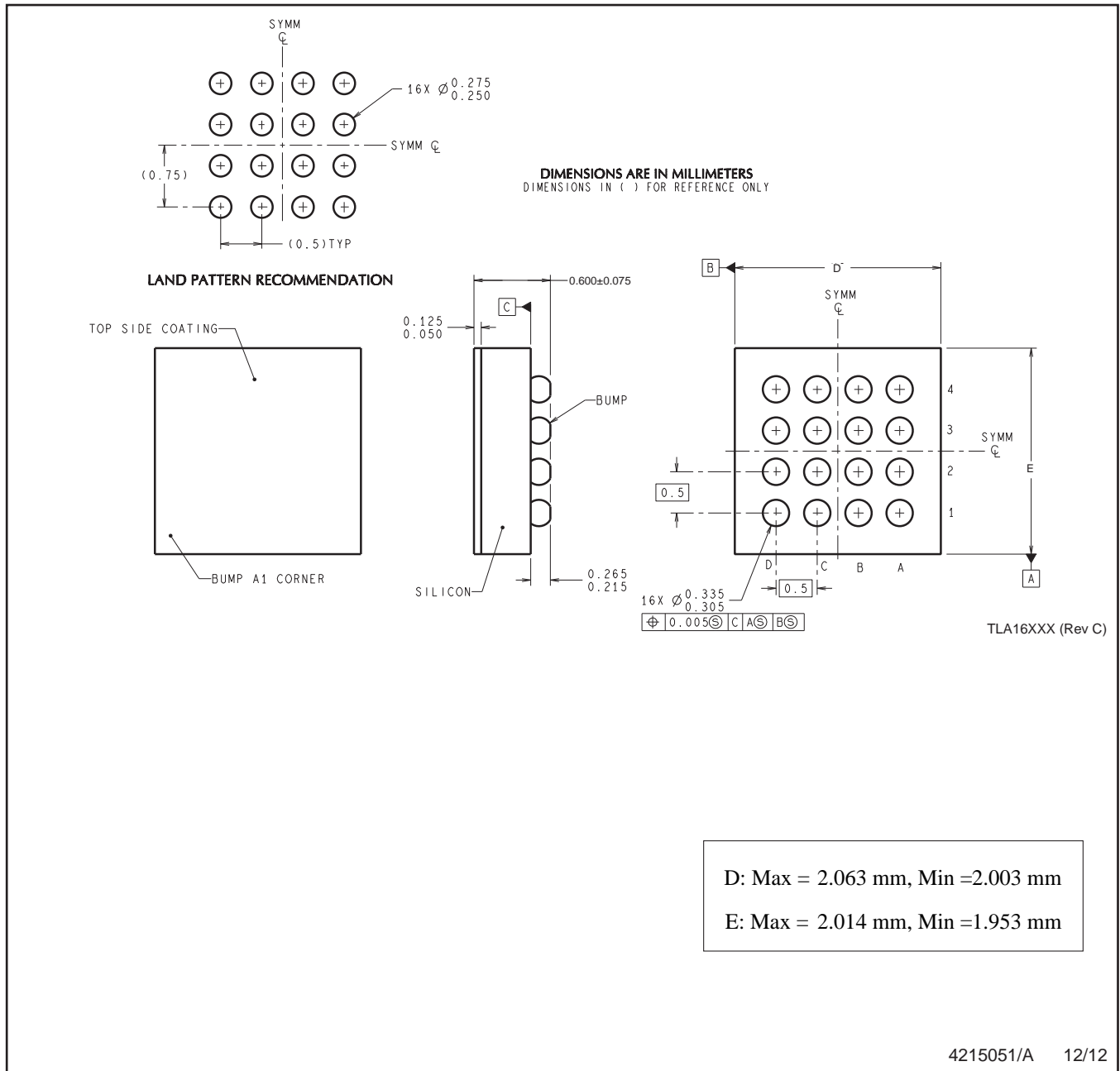

NOTES: A. All linear dimensions are in millimeters. Dimensioning and tolerancing per ASME Y14.5M-1994.
B. This drawing is subject to change without notice.

IMPORTANT NOTICE

Texas Instruments Incorporated and its subsidiaries (TI) reserve the right to make corrections, enhancements, improvements and other changes to its semiconductor products and services per JESD46, latest issue, and to discontinue any product or service per JESD48, latest issue. Buyers should obtain the latest relevant information before placing orders and should verify that such information is current and complete. All semiconductor products (also referred to herein as "components") are sold subject to TI's terms and conditions of sale supplied at the time of order acknowledgment.

TI warrants performance of its components to the specifications applicable at the time of sale, in accordance with the warranty in TI's terms and conditions of sale of semiconductor products. Testing and other quality control techniques are used to the extent TI deems necessary to support this warranty. Except where mandated by applicable law, testing of all parameters of each component is not necessarily performed.

TI assumes no liability for applications assistance or the design of Buyers' products. Buyers are responsible for their products and applications using TI components. To minimize the risks associated with Buyers' products and applications, Buyers should provide adequate design and operating safeguards.

TI does not warrant or represent that any license, either express or implied, is granted under any patent right, copyright, mask work right, or other intellectual property right relating to any combination, machine, or process in which TI components or services are used. Information published by TI regarding third-party products or services does not constitute a license to use such products or services or a warranty or endorsement thereof. Use of such information may require a license from a third party under the patents or other intellectual property of the third party, or a license from TI under the patents or other intellectual property of TI.

Reproduction of significant portions of TI information in TI data books or data sheets is permissible only if reproduction is without alteration and is accompanied by all associated warranties, conditions, limitations, and notices. TI is not responsible or liable for such altered documentation. Information of third parties may be subject to additional restrictions.

Resale of TI components or services with statements different from or beyond the parameters stated by TI for that component or service voids all express and any implied warranties for the associated TI component or service and is an unfair and deceptive business practice. TI is not responsible or liable for any such statements.

Buyer acknowledges and agrees that it is solely responsible for compliance with all legal, regulatory and safety-related requirements concerning its products, and any use of TI components in its applications, notwithstanding any applications-related information or support that may be provided by TI. Buyer represents and agrees that it has all the necessary expertise to create and implement safeguards which anticipate dangerous consequences of failures, monitor failures and their consequences, lessen the likelihood of failures that might cause harm and take appropriate remedial actions. Buyer will fully indemnify TI and its representatives against any damages arising out of the use of any TI components in safety-critical applications.

In some cases, TI components may be promoted specifically to facilitate safety-related applications. With such components, TI's goal is to help enable customers to design and create their own end-product solutions that meet applicable functional safety standards and requirements. Nonetheless, such components are subject to these terms.

No TI components are authorized for use in FDA Class III (or similar life-critical medical equipment) unless authorized officers of the parties have executed a special agreement specifically governing such use.

Only those TI components which TI has specifically designated as military grade or "enhanced plastic" are designed and intended for use in military/aerospace applications or environments. Buyer acknowledges and agrees that any military or aerospace use of TI components which have **not** been so designated is solely at the Buyer's risk, and that Buyer is solely responsible for compliance with all legal and regulatory requirements in connection with such use.

TI has specifically designated certain components as meeting ISO/TS16949 requirements, mainly for automotive use. In any case of use of non-designated products, TI will not be responsible for any failure to meet ISO/TS16949.

Products

Audio	www.ti.com/audio
Amplifiers	amplifier.ti.com
Data Converters	dataconverter.ti.com
DLP® Products	www.dlp.com
DSP	dsp.ti.com
Clocks and Timers	www.ti.com/clocks
Interface	interface.ti.com
Logic	logic.ti.com
Power Mgmt	power.ti.com
Microcontrollers	microcontroller.ti.com
RFID	www.ti-rfid.com
OMAP Applications Processors	www.ti.com/omap
Wireless Connectivity	www.ti.com/wirelessconnectivity

Applications

Automotive and Transportation	www.ti.com/automotive
Communications and Telecom	www.ti.com/communications
Computers and Peripherals	www.ti.com/computers
Consumer Electronics	www.ti.com/consumer-apps
Energy and Lighting	www.ti.com/energy
Industrial	www.ti.com/industrial
Medical	www.ti.com/medical
Security	www.ti.com/security
Space, Avionics and Defense	www.ti.com/space-avionics-defense
Video and Imaging	www.ti.com/video

TI E2E Community

e2e.ti.com