

LM9071 Low-Dropout System Voltage Regulator with Delayed Reset

Check for Samples: [LM9071](#)

FEATURES

- Automotive Application Reliability
- 3% Output Voltage Tolerance
- Insensitive to Radiated RFI
- Dropout Voltage Less than 800 mV with 250 mA Output Current
- Externally Programmed Reset Delay Interval
- Thermal Shutdown
- Short Circuit Protection
- Reverse Battery Protection
- Wide Operating Temperature Range -40°C to $+125^{\circ}\text{C}$
- TO-220 and TO-263 Power Surface Mount Power Packages
- Pin for Pin Compatible with the LM2927, L4947 and TLE4260

DESCRIPTION

The LM9071 is a 5V, 250 mA low-dropout voltage regulator. The regulator features an active low delayed reset output flag which can be used to reset a microprocessor system on turn-ON and in the event that the regulator output falls out of regulation for any reason. An external capacitor programs a delay time interval before the reset output can return high.

Designed for automotive application the LM9071 contains a variety of protection features such as reverse battery, over-voltage shutdown, thermal shutdown, input transient protection and a wide operating temperature range.

Design techniques have been employed to allow the regulator to remain operational and not generate false reset signals when subjected to high levels of RF energy (300V/m from 2 MHz to 400 MHz).

Typical Application and Connection Diagrams

(Top View)

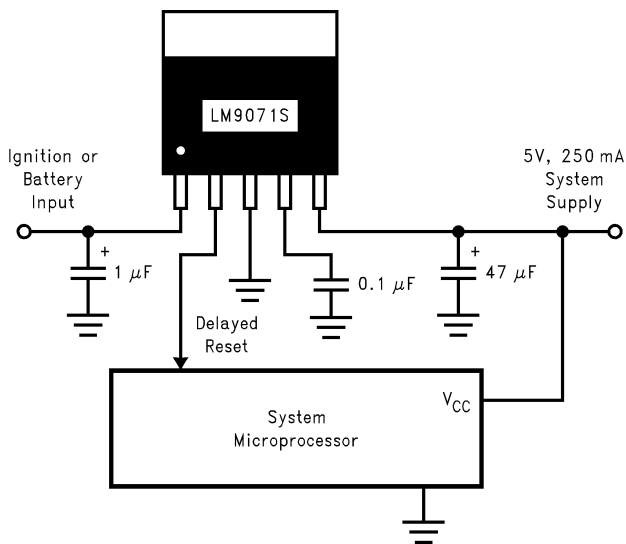
Figure 1.

**Figure 2. 5-Lead TO-220 Package
Package Number KC0005A**

Please be aware that an important notice concerning availability, standard warranty, and use in critical applications of Texas Instruments semiconductor products and disclaimers thereto appears at the end of this data sheet.

All trademarks are the property of their respective owners.

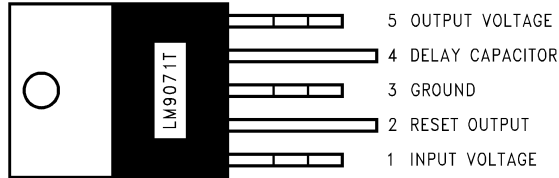

**Figure 3. 5-Lead TO-220 Package
Package Number NDH0005D**

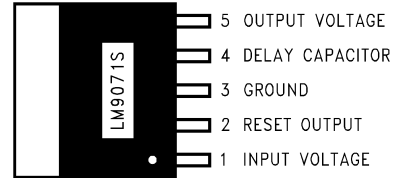

Tab and Backside metal on all packages internally connected to ground.

**Figure 4. 5-Lead TO-263 Surface Mount Package
Package Number KTT0005B**



These devices have limited built-in ESD protection. The leads should be shorted together or the device placed in conductive foam during storage or handling to prevent electrostatic damage to the MOS gates.

Absolute Maximum Ratings ⁽¹⁾

| | |
|------------------------------------------|--------------------|
| DC Input Voltage | -26V to +40V |
| Positive Input Transient (t<100 ms) | 60V |
| Negative Input Transient (t<1 ms) | -50V |
| Reset Output Sink Current | 5 mA |
| Power Dissipation | Internally Limited |
| Junction Temperature | 150°C |
| ESD Susceptibility ⁽²⁾ | 12 kV, 2 kV |
| Lead Temperature (Soldering, 10 seconds) | 260°C |
| Storage Temperature | -50°C to +150°C |

- (1) Absolute Maximum Ratings indicate limits beyond which damage to the device may occur. Operating Ratings indicate conditions for which the device is intended to be functional, but do not ensure specific performance limits. For ensured specifications and conditions, see the Electrical Characteristics.
- (2) All pins will survive an ESD impulse of $\pm 2000V$ using the human body model of 100 pF discharged through a 1.5 k Ω resistor. In addition the input voltage pin will withstand ten pulses of ± 12 kV from a 150 pF capacitor discharged through a 560 Ω resistor when bypassed with a 22 nF, 100V capacitor.

Operating Ratings ⁽¹⁾

| | |
|----------------------------------------------------------|-----------------|
| Input Voltage | 6V to 26V |
| Ambient Temperature | -40°C to +125°C |
| TO-220 Thermal Resistance, θ_{J-C} | 3°C/W |
| TO-220 Thermal Resistance, θ_{J-A} ⁽²⁾ | 73°C/W |
| TO-263 Thermal Resistance, θ_{J-C} | 3°C/W |
| TO-263 Thermal Resistance, θ_{J-A} ⁽³⁾ | 80°C/W |

- (1) Absolute Maximum Ratings indicate limits beyond which damage to the device may occur. Operating Ratings indicate conditions for which the device is intended to be functional, but do not ensure specific performance limits. For ensured specifications and conditions, see the Electrical Characteristics.
- (2) Exceeding the Maximum Allowable power dissipation will cause excessive die temperature, and the device will go into thermal shutdown. The θ_{J-A} value for the TO-220 package (still air, no additional heat sink) is 73°C/W. The effective θ_{J-A} value of the TO-220 package can be reduced by using conventional heat sink methods.
- (3) Exceeding the Maximum Allowable power dissipation will cause excessive die temperature, and the device will go into thermal shutdown. The θ_{J-A} value for the TO-263 package (still air, no additional heat sink) is 80°C/W. The effective θ_{J-A} value of the TO-263 package can be reduced by increasing the printed circuit board area that is connected (soldered) to the package tab. Using 1 ounce (1.4 mils thick) copper clad with no solder mask, an area of 0.5 square inches will reduce θ_{J-A} to 50°C/W, an area of 1.0 square inches will reduce θ_{J-A} to 37°C/W, and an area of 1.6 square inches will reduce θ_{J-A} to 32°C/W. If the printed circuit board uses a solder mask, the copper clad area should be increased by at least 50% to maintain a similar θ_{J-A} rating.

Electrical Characteristics ⁽¹⁾

The following specifications apply for $V_{CC} = 6V$ to $26V$, $-40^{\circ}C \leq T_A \leq +125^{\circ}C$, unless otherwise specified. $C_{OUT} = 47\mu F$ with an $ESR < 3\Omega$. $C_{IN} = 1\mu F$.

| Symbol | Parameter | Conditions | Min | Max | Units |
|-------------------------|----------------------------------|---------------------------------------------------------------------------------------|---------------|------|------------|
| REGULATOR OUTPUT | | | | | |
| V_{OUT} | Output Voltage | $5\text{ mA} \leq I_{OUT} \leq 250\text{ mA}$ | 4.85 | 5.15 | V |
| ΔV_{OUT} Line | Line Regulation | $I_{OUT} = 5\text{ mA}$, $9V \leq V_{IN} \leq 16.5V$ | | 25 | mV |
| | | $I_{OUT} = 250\text{ mA}$ | | 50 | mV |
| ΔV_{OUT} Load | Load Regulation | $V_{IN} = 14.4V$, $5\text{ mA} \leq I_{OUT} \leq 250\text{ mA}$ | | 60 | mV |
| I_q | Quiescent Current | $I_{OUT} = 5\text{ mA}$ | | 4 | mA |
| | | $I_{OUT} = 250\text{ mA}$, $V_{IN} \geq 8V$ | | 25 | mA |
| | | $I_{OUT} = 5\text{ mA}$, $V_{IN} = 5V$ | | 10 | mA |
| | | $I_{OUT} = 250\text{ mA}$, $V_{IN} = 6V$ | | 50 | mA |
| V_{do} | Dropout Voltage | $I_{OUT} = 5\text{ mA}$ | | 300 | mV |
| | | $I_{OUT} = 250\text{ mA}$ | | 800 | mV |
| I_{sc} | Short Circuit Current | $R_L = 1\Omega$ | 0.35 | 1.5 | A |
| PSRR | Ripple Rejection | $V_{IN} = (14V_{DC}) + (1V_{RMS} @ 120Hz)$ $I_{OUT} = 50\text{ mA}$ | 60 | | dB |
| OVthr | Overvoltage Shutdown Threshold | | 27 | | V |
| V_O Transient | V_{OUT} during Transients | V_{IN} Peak $\leq 60V$, $R_L = 100\Omega$, $\tau = 100\text{ ms}$ | | 7 | V |
| V_O Rev Batt | V_{OUT} during Reverse Battery | $V_{IN} = -15V$ | -0.8 | 0.0 | V |
| RESET OUTPUT | | | | | |
| V_{th} | Threshold Voltage | ΔV_{OUT} Required to Generate a Reset Output $4.8V \leq V_{OUT} \leq 5.2V$ | -300 | -500 | mV |
| V_{low} | Reset Output Low Voltage | $I_{sink} = 1.6\text{ mA}$, $V_{OUT} > 3.2V$ | | 0.4 | V |
| | | $1.4V \leq V_{OUT} \leq 3.2V$ | | 0.8 | V |
| V_{high} | Reset Output High Voltage | | $0.8 V_{OUT}$ | | V |
| t_{DELAY} | Delay Time | $C_{DELAY} = 0.1\mu F$ | 7.6 | 35 | ms |
| I_{DELAY} | Charging Current for C_{DELAY} | | 10 | 30 | μA |
| R_{pu} | Internal Pull-up Resistance | | 12 | 80 | k Ω |

(1) Datasheet min/max specifications are ensured by design, test, and/or statistical analysis.

Typical Performance Characteristics

($T_A = 25^\circ\text{C}$ unless indicated otherwise)

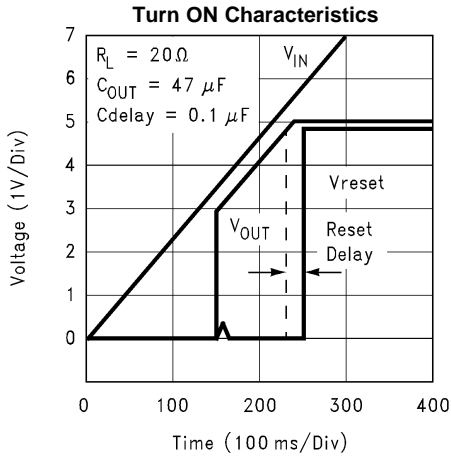

Figure 5.

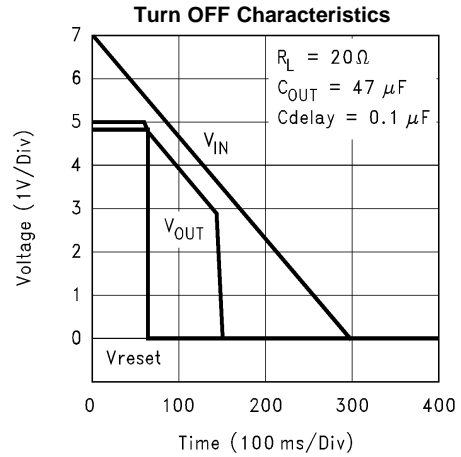

Figure 6.

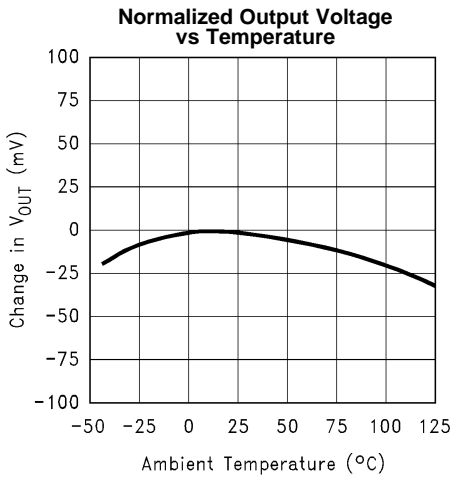

Figure 7.

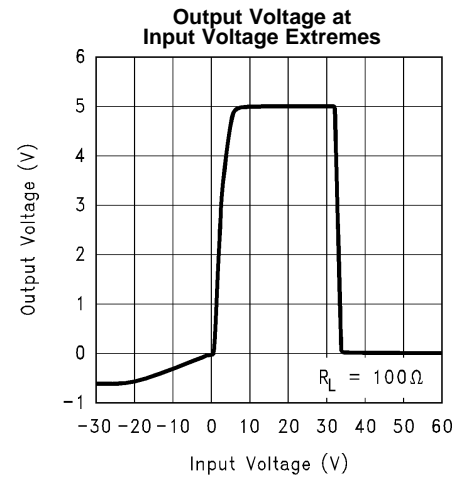

Figure 8.

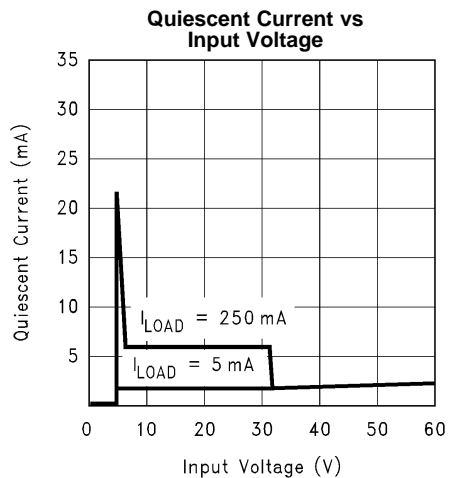

Figure 9.

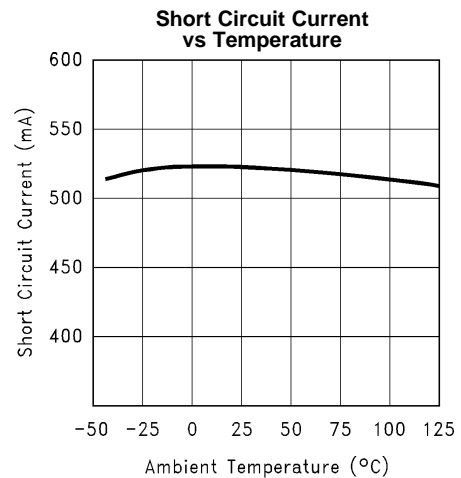

Figure 10.

Typical Performance Characteristics (continued)

($T_A = 25^\circ\text{C}$ unless indicated otherwise)

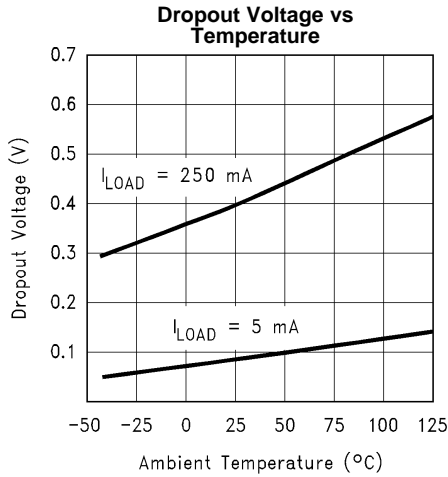

Figure 11.

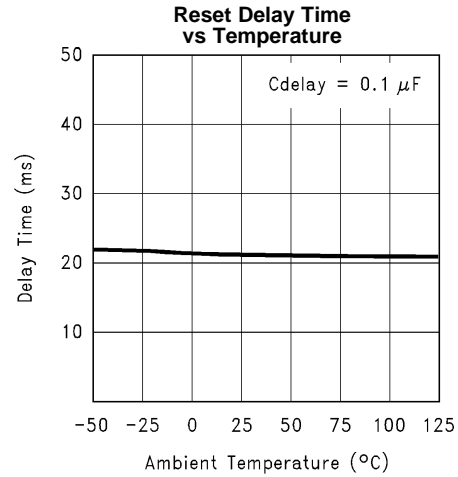

Figure 12.

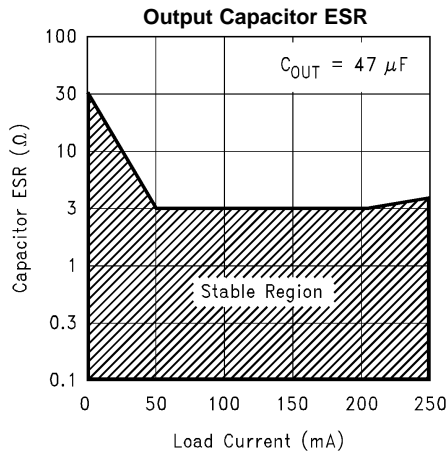

Figure 13.

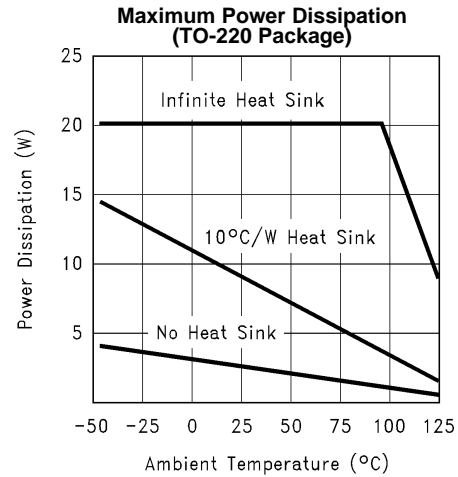

Figure 14.

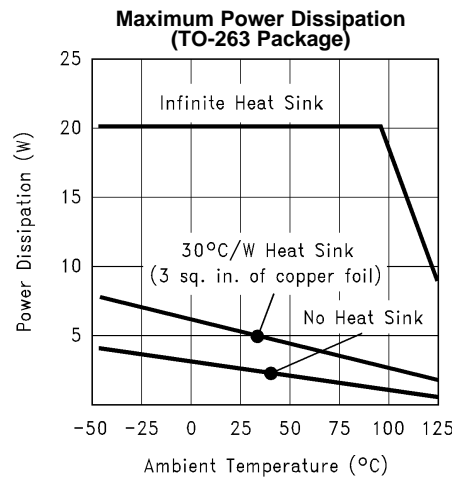
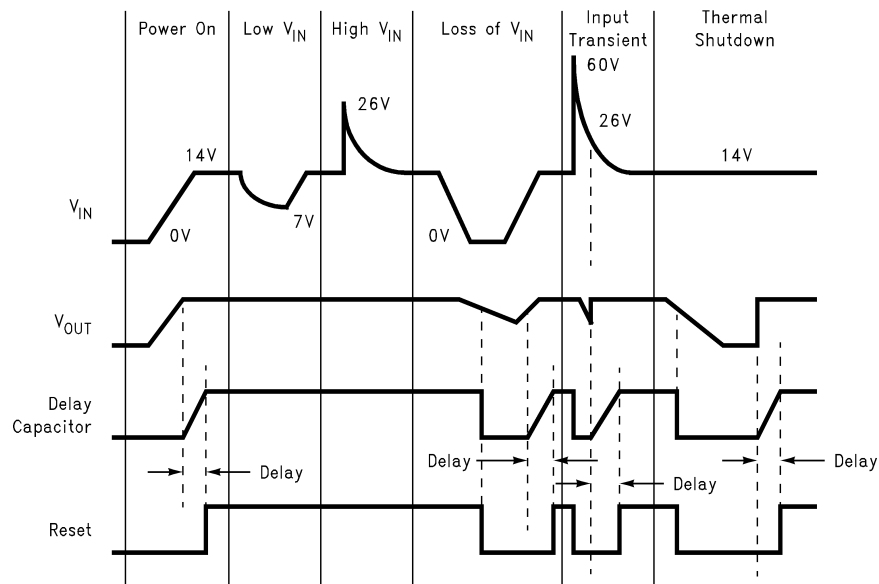
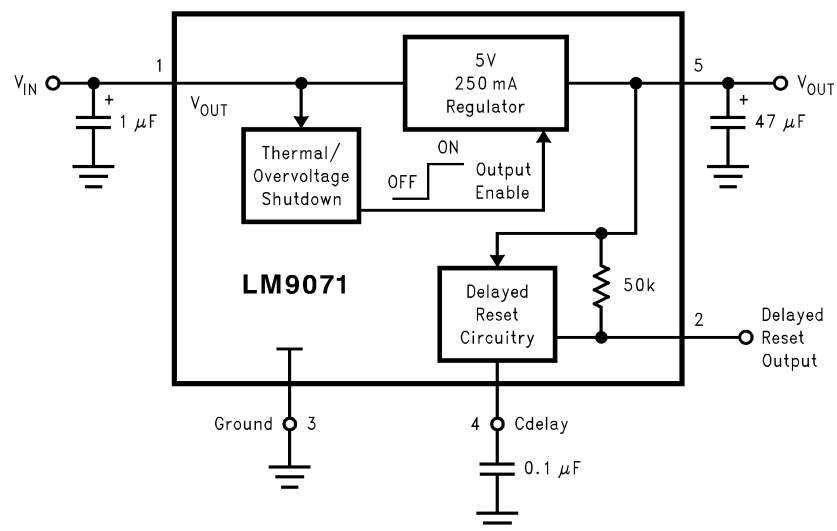

Figure 15.

Reset Operation and Protection Features



Block Diagram



APPLICATION HINTS

The LM9071 voltage regulator has been optimized for use in microprocessor based automotive systems. Several unique design features have been incorporated to address many FMEA (Failure Mode Effects Analysis) concerns for fail-safe system performance.

FAULT TOLERANT FEATURES

While not specifically ensured due to production testing limitations, the LM9071 has been tested and shown to continue to provide a regulated output and, not generate an erroneous system reset signal while subjected to high levels of RF electric field energy (up to 300 V/m signal strength over a 2 MHz to 400 MHz frequency range). This is very important in vehicle safety related applications where the system must continue to operate normally. To maintain this immunity to RFI the output bypass capacitor is important (47 μ F is recommended).

An output bypass capacitor of at least 10 μF is required for stability (47 μF is recommended). The ESR of this capacitor should be less than 3 Ω . An input capacitor of 1 μF or larger is recommended to improve line transient and noise performance.

Conventional load dump protection is built in to withstand up to +60V and –50V transients. Protection against reverse polarity battery connections is also built in. With a reversed battery connection the output of the LM9071 will not go more negative than one diode drop below ground. This will prevent damage to any of the 5V load circuits.

RESET FLAG

Excessive loading of the output to the point where the output voltage drops by 300 mV to 500 mV will signal a reset flag to the micro. This will warn of a V_{CC} supply that may produce unpredictable operation of the system. On power-up and recovery from a fault condition the delay capacitor is used to hold the micro in a reset condition for a programmable time interval to allow the system operating voltages and clock to stabilize before executing code. The delay time interval can be estimated by the following equation:

$$t_{\text{DELAY}} = \frac{3.8\text{V} \times C_{\text{DELAY}}}{20 \mu\text{A}} \quad (1)$$

INPUT STABILITY

Low dropout voltage regulators which utilize a PNP power transistor usually exhibit a large increase in current when in dropout ($V_{\text{IN}} < 5.5\text{V}$). This increase is caused by the saturation characteristics (β reduction) of the PNP transistor. To significantly minimize this increase in current the LM9071 detects when the PNP enters saturation and reduces the operating current.

This reduction in input current can create a stability problem in applications with higher load current (> 100 mA) where the input voltage is applied through a long length of wire, which in effect adds a significant amount of inductance in series with the input. The drop in input current may create a positive input voltage transient which may take the PNP out of saturation. If the input voltage is held constant at the threshold where the PNP is going in and out of saturation, an oscillation may be created.

This is only observed where a large series inductance is present in the input supply line and when the rise and fall time of the input supply is very slow. If the application and removal of the input voltage changes at a rate greater than 500 mV/ μs it will move through the dropout region of the regulator (V_{IN} of 3V to 5.5V) too quickly for an oscillation to be established.

THERMAL MANAGEMENT

The LM9071 is packaged in both a TO-263 surface mount power package and a narrow lead-pitch TO-220 package. To obtain operation over the highest possible load current and input voltage ranges, care must be taken to control the operating temperature of the device. Thermal shutdown protection is built in, with a threshold above 150°C. Conventional heat-sinking techniques can be used with the TO-220 package. When applying the TO-263 package, on board heat-sinking is important to prevent premature thermal shutdown. More copper foil area under the tab of the device will directly improve the operating $\theta_{\text{J-A}}$ of the TO-263 package, which will reduce the junction temperature of the device.

The $\theta_{\text{J-A}}$ value for the TO-263 package (still air, no additional heat sink) is rated at 80°C/W. The effective $\theta_{\text{J-A}}$ value of the TO-263 package can be reduced by increasing the printed circuit board area that is connected (soldered) to the package tab. Using 1 ounce (1.4 mils thick) copper clad with no solder mask, an area of 0.5 square inches will reduce $\theta_{\text{J-A}}$ to 50°C/W, an area of 1.0 square inches will reduce $\theta_{\text{J-A}}$ to 37°C/W, and an area of 1.6 square inches will reduce $\theta_{\text{J-A}}$ to 32°C/W. If the printed circuit board uses a solder mask, the copper clad area under the solder mask should be increased by at least 50% to maintain a similar $\theta_{\text{J-A}}$ rating.

The use of a double sided PC board with soldered filled vias between two planes of copper, as shown in [Figure 16](#), will improve thermal performance while optimizing the PC board surface area required. Using the double sided PC board arrangement shown in [Figure 16](#), with 1 ounce (1.4 mils thick) copper clad with no solder mask and solder filled vias, an area of 0.5 square inches on both sides will reduce $\theta_{\text{J-A}}$ to 43°C/W.

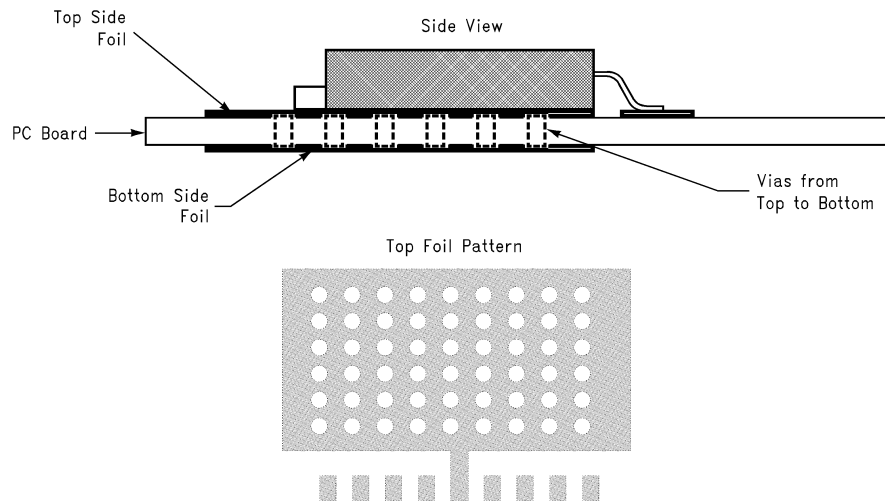



Figure 16. Typical TO-263 PC Board Heatsinking

REVISION HISTORY

| Changes from Revision C (April 2013) to Revision D | Page |
|------------------------------------------------------------------------------------------------------------------|----------------|
| <hr/> <ul style="list-style-type: none">• Changed layout of National Data Sheet to TI format | <hr/> 8 |

PACKAGING INFORMATION

| Orderable Device | Status (1) | Package Type | Package Drawing | Pins | Package Qty | Eco Plan (2) | Lead/Ball Finish (6) | MSL Peak Temp (3) | Op Temp (°C) | Device Marking (4/5) | Samples |
|------------------|---------------|------------------|-----------------|------|-------------|--------------------------|-------------------------|----------------------|--------------|-------------------------|-------------------------------------------------------------------------------------|
| LM9071S/NOPB | ACTIVE | DDPAK/ TO-263 | KTT | 5 | 45 | Pb-Free (RoHS Exempt) | CU SN | Level-3-245C-168 HR | -40 to 125 | LM9071S |  |
| LM9071SX | NRND | DDPAK/ TO-263 | KTT | 5 | | TBD | Call TI | Call TI | -40 to 125 | | |
| LM9071SX/NOPB | ACTIVE | DDPAK/ TO-263 | KTT | 5 | 500 | Pb-Free (RoHS Exempt) | CU SN | Level-3-245C-168 HR | -40 to 125 | LM9071S |  |

(1) The marketing status values are defined as follows:

ACTIVE: Product device recommended for new designs.

LIFEBUY: TI has announced that the device will be discontinued, and a lifetime-buy period is in effect.

NRND: Not recommended for new designs. Device is in production to support existing customers, but TI does not recommend using this part in a new design.

PREVIEW: Device has been announced but is not in production. Samples may or may not be available.

OBSOLETE: TI has discontinued the production of the device.

(2) Eco Plan - The planned eco-friendly classification: Pb-Free (RoHS), Pb-Free (RoHS Exempt), or Green (RoHS & no Sb/Br) - please check <http://www.ti.com/productcontent> for the latest availability information and additional product content details.

TBD: The Pb-Free/Green conversion plan has not been defined.

Pb-Free (RoHS): TI's terms "Lead-Free" or "Pb-Free" mean semiconductor products that are compatible with the current RoHS requirements for all 6 substances, including the requirement that lead not exceed 0.1% by weight in homogeneous materials. Where designed to be soldered at high temperatures, TI Pb-Free products are suitable for use in specified lead-free processes.

Pb-Free (RoHS Exempt): This component has a RoHS exemption for either 1) lead-based flip-chip solder bumps used between the die and package, or 2) lead-based die adhesive used between the die and leadframe. The component is otherwise considered Pb-Free (RoHS compatible) as defined above.

Green (RoHS & no Sb/Br): TI defines "Green" to mean Pb-Free (RoHS compatible), and free of Bromine (Br) and Antimony (Sb) based flame retardants (Br or Sb do not exceed 0.1% by weight in homogeneous material)

(3) MSL, Peak Temp. - The Moisture Sensitivity Level rating according to the JEDEC industry standard classifications, and peak solder temperature.

(4) There may be additional marking, which relates to the logo, the lot trace code information, or the environmental category on the device.

(5) Multiple Device Markings will be inside parentheses. Only one Device Marking contained in parentheses and separated by a "~" will appear on a device. If a line is indented then it is a continuation of the previous line and the two combined represent the entire Device Marking for that device.

(6) Lead/Ball Finish - Orderable Devices may have multiple material finish options. Finish options are separated by a vertical ruled line. Lead/Ball Finish values may wrap to two lines if the finish value exceeds the maximum column width.

Important Information and Disclaimer: The information provided on this page represents TI's knowledge and belief as of the date that it is provided. TI bases its knowledge and belief on information provided by third parties, and makes no representation or warranty as to the accuracy of such information. Efforts are underway to better integrate information from third parties. TI has taken and

continues to take reasonable steps to provide representative and accurate information but may not have conducted destructive testing or chemical analysis on incoming materials and chemicals. TI and TI suppliers consider certain information to be proprietary, and thus CAS numbers and other limited information may not be available for release.

In no event shall TI's liability arising out of such information exceed the total purchase price of the TI part(s) at issue in this document sold by TI to Customer on an annual basis.

TAPE AND REEL INFORMATION

QUADRANT ASSIGNMENTS FOR PIN 1 ORIENTATION IN TAPE

*All dimensions are nominal

| Device | Package Type | Package Drawing | Pins | SPQ | Reel Diameter (mm) | Reel Width W1 (mm) | A0 (mm) | B0 (mm) | K0 (mm) | P1 (mm) | W (mm) | Pin1 Quadrant |
|---------------|------------------|-----------------|------|-----|--------------------|--------------------|---------|---------|---------|---------|--------|---------------|
| LM9071SX/NOPB | DDPAK/ TO-263 | KTT | 5 | 500 | 330.0 | 24.4 | 10.75 | 14.85 | 5.0 | 16.0 | 24.0 | Q2 |

TAPE AND REEL BOX DIMENSIONS

*All dimensions are nominal

| Device | Package Type | Package Drawing | Pins | SPQ | Length (mm) | Width (mm) | Height (mm) |
|---------------|--------------|-----------------|------|-----|-------------|------------|-------------|
| LM9071SX/NOPB | DDPAK/TO-263 | KTT | 5 | 500 | 367.0 | 367.0 | 45.0 |

KTT0005B



CONTROLLING DIMENSION IS INCH
VALUES IN [] ARE MILLIMETERS
DIMENSIONS IN () FOR REFERENCE ONLY

TS5B (Rev D)

IMPORTANT NOTICE

Texas Instruments Incorporated and its subsidiaries (TI) reserve the right to make corrections, enhancements, improvements and other changes to its semiconductor products and services per JESD46, latest issue, and to discontinue any product or service per JESD48, latest issue. Buyers should obtain the latest relevant information before placing orders and should verify that such information is current and complete. All semiconductor products (also referred to herein as "components") are sold subject to TI's terms and conditions of sale supplied at the time of order acknowledgment.

TI warrants performance of its components to the specifications applicable at the time of sale, in accordance with the warranty in TI's terms and conditions of sale of semiconductor products. Testing and other quality control techniques are used to the extent TI deems necessary to support this warranty. Except where mandated by applicable law, testing of all parameters of each component is not necessarily performed.

TI assumes no liability for applications assistance or the design of Buyers' products. Buyers are responsible for their products and applications using TI components. To minimize the risks associated with Buyers' products and applications, Buyers should provide adequate design and operating safeguards.

TI does not warrant or represent that any license, either express or implied, is granted under any patent right, copyright, mask work right, or other intellectual property right relating to any combination, machine, or process in which TI components or services are used. Information published by TI regarding third-party products or services does not constitute a license to use such products or services or a warranty or endorsement thereof. Use of such information may require a license from a third party under the patents or other intellectual property of the third party, or a license from TI under the patents or other intellectual property of TI.

Reproduction of significant portions of TI information in TI data books or data sheets is permissible only if reproduction is without alteration and is accompanied by all associated warranties, conditions, limitations, and notices. TI is not responsible or liable for such altered documentation. Information of third parties may be subject to additional restrictions.

Resale of TI components or services with statements different from or beyond the parameters stated by TI for that component or service voids all express and any implied warranties for the associated TI component or service and is an unfair and deceptive business practice. TI is not responsible or liable for any such statements.

Buyer acknowledges and agrees that it is solely responsible for compliance with all legal, regulatory and safety-related requirements concerning its products, and any use of TI components in its applications, notwithstanding any applications-related information or support that may be provided by TI. Buyer represents and agrees that it has all the necessary expertise to create and implement safeguards which anticipate dangerous consequences of failures, monitor failures and their consequences, lessen the likelihood of failures that might cause harm and take appropriate remedial actions. Buyer will fully indemnify TI and its representatives against any damages arising out of the use of any TI components in safety-critical applications.

In some cases, TI components may be promoted specifically to facilitate safety-related applications. With such components, TI's goal is to help enable customers to design and create their own end-product solutions that meet applicable functional safety standards and requirements. Nonetheless, such components are subject to these terms.

No TI components are authorized for use in FDA Class III (or similar life-critical medical equipment) unless authorized officers of the parties have executed a special agreement specifically governing such use.

Only those TI components which TI has specifically designated as military grade or "enhanced plastic" are designed and intended for use in military/aerospace applications or environments. Buyer acknowledges and agrees that any military or aerospace use of TI components which have **not** been so designated is solely at the Buyer's risk, and that Buyer is solely responsible for compliance with all legal and regulatory requirements in connection with such use.

TI has specifically designated certain components as meeting ISO/TS16949 requirements, mainly for automotive use. In any case of use of non-designated products, TI will not be responsible for any failure to meet ISO/TS16949.

Products

| | |
|------------------------------|--------------------------------------------------------------------------------------|
| Audio | www.ti.com/audio |
| Amplifiers | amplifier.ti.com |
| Data Converters | dataconverter.ti.com |
| DLP® Products | www.dlp.com |
| DSP | dsp.ti.com |
| Clocks and Timers | www.ti.com/clocks |
| Interface | interface.ti.com |
| Logic | logic.ti.com |
| Power Mgmt | power.ti.com |
| Microcontrollers | microcontroller.ti.com |
| RFID | www.ti-rfid.com |
| OMAP Applications Processors | www.ti.com/omap |
| Wireless Connectivity | www.ti.com/wirelessconnectivity |

Applications

| | |
|-------------------------------|------------------------------------------------------------------------------------------|
| Automotive and Transportation | www.ti.com/automotive |
| Communications and Telecom | www.ti.com/communications |
| Computers and Peripherals | www.ti.com/computers |
| Consumer Electronics | www.ti.com/consumer-apps |
| Energy and Lighting | www.ti.com/energy |
| Industrial | www.ti.com/industrial |
| Medical | www.ti.com/medical |
| Security | www.ti.com/security |
| Space, Avionics and Defense | www.ti.com/space-avionics-defense |
| Video and Imaging | www.ti.com/video |

TI E2E Community

e2e.ti.com