

TRF3722 Quadrature Modulator with Integrated PLL and VCO

1 Features

- IQ Modulator with Integrated PLL and VCO
- Integer-N/Fractional-N PLL
- Modulator Supports 400 MHz to 4200 MHz
- PLL and VCO Supports 256 MHz to 4100 MHz
- OIP3 at 900 MHz = 31 dBm
- OIP3 at 1800 MHz = 30 dBm
- VCO 1800MHz Open Loop Phase Noise = -141 dBc/Hz at 1 MHz Offset
- Independent LO Output Supports divide-by 1/2/4/8
- Modulator Low Power and High Gain Modes
- Multiple Power Down Modes

2 Applications

- Wireless Infrastructure
 - CDMA: IS95, UMTS, CDMA2000, TD-SCDMA
 - LTE, TD-LTE, LTE Advanced
 - TDMA: GSM, EDGE, MC-GSM
- Point-to-Point Microwave, Point-to-Multipoint Microwave
- Software Defined Radios
- RF Repeaters, Distributed Antenna Systems

4 Block Diagram

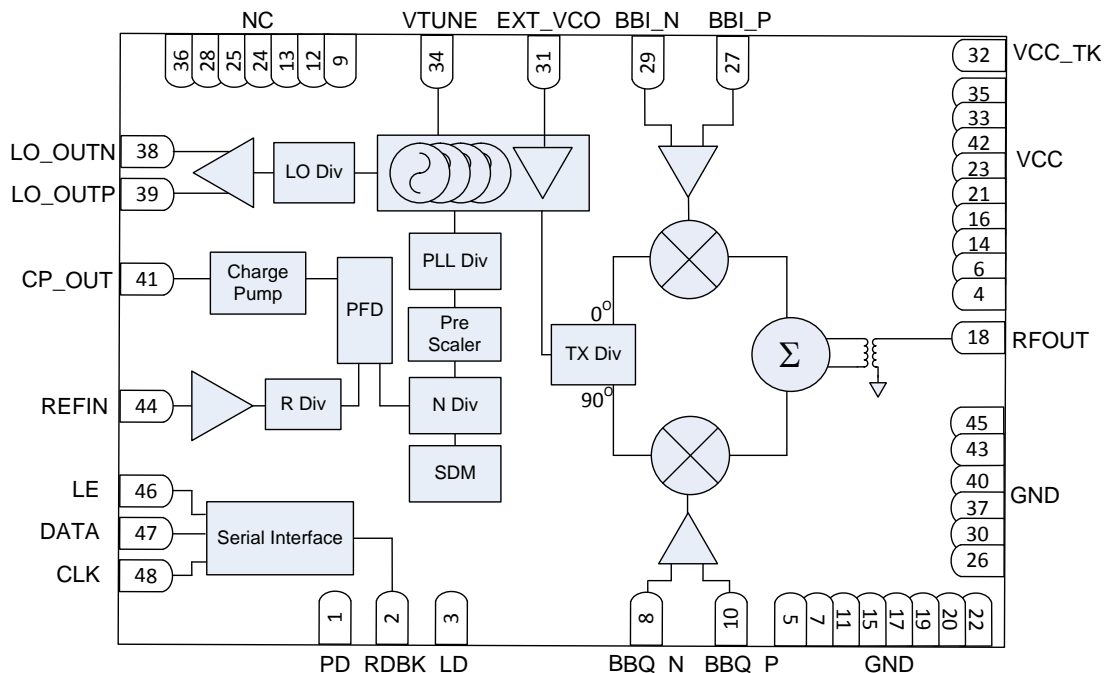

3 Description

TRF3722 is a high performance direct conversion quadrature modulator with exceptional linearity and low noise performance. The typical 0.25 V baseband common mode voltage supports seamless interface with current source DACs. The device integrates the PLL and VCO to provide the local oscillator (LO) to the modulator. The PLL and VCO provides excellent phase noise performance to satisfy the most stringent transmit communication requirements. The device also provides additional LO output for driving a second modulator or down converting mixer. The modulator features a high gain mode for a typical 3 dB gain increase and a low power mode when power optimization is desired.

Device Information ⁽¹⁾

PART NUMBER	PACKAGE	BODY SIZE (NOM)
TRF3722	VQFN (48)	7.00mm x 7.00mm

(1) For all available packages, see the orderable addendum at the end of the datasheet.



Table of Contents

1 Features	1	7.17 Typical Characteristics - RF Output Return Loss .	22
2 Applications	1	7.18 Typical Characteristics - PLL/VCO	23
3 Description	1	7.19 Typical Characteristics - Current Consumption	29
4 Block Diagram	1	7.20 Typical Characteristics - Power Dissipation	31
5 Revision History	2	8 Parameter Measurement Information	33
6 Pin Configuration and Functions	3	8.1 Serial Interface Timing Diagram	33
7 Specifications	4	9 Detailed Description	35
7.1 Absolute Maximum Ratings	4	9.1 Overview	35
7.2 Handling Ratings	4	9.2 Functional Block Diagram	35
7.3 Recommended Operating Conditions	4	9.3 Feature Description	36
7.4 Thermal Information	5	9.4 Device Functional Modes	39
7.5 Electrical Characteristics	5	9.5 Register Maps	42
7.6 Typical Characteristics	9	10 Applications and Implementation	55
7.7 Typical Characteristics - Output Power	10	10.1 Application Information	55
7.8 Typical Characteristics - Gain	11	11 Power Supply Recommendations	57
7.9 Typical Characteristics - OIP3	12	12 Layout	58
7.10 Typical Characteristics - OIP2	13	12.1 Layout Guidelines	58
7.11 Typical Characteristics - OP1dB	14	12.2 Layout Example	58
7.12 Typical Characteristics - Noise	15	13 Device and Documentation Support	59
7.13 Typical Characteristics - Unadjusted CF	16	13.1 Trademarks	59
7.14 Typical Characteristics - Unadjusted SBS	17	13.2 Electrostatic Discharge Caution	59
7.15 Typical Characteristics - LO Harmonic	18	13.3 Glossary	59
7.16 Typical Characteristics - BB Harmonic	20	14 Mechanical, Packaging, and Orderable Information	59

5 Revision History

Changes from Original (May 2014) to Revision A

Page

• Changed from 1-page Product Preview to Production	1
---	----------

6 Pin Configuration and Functions

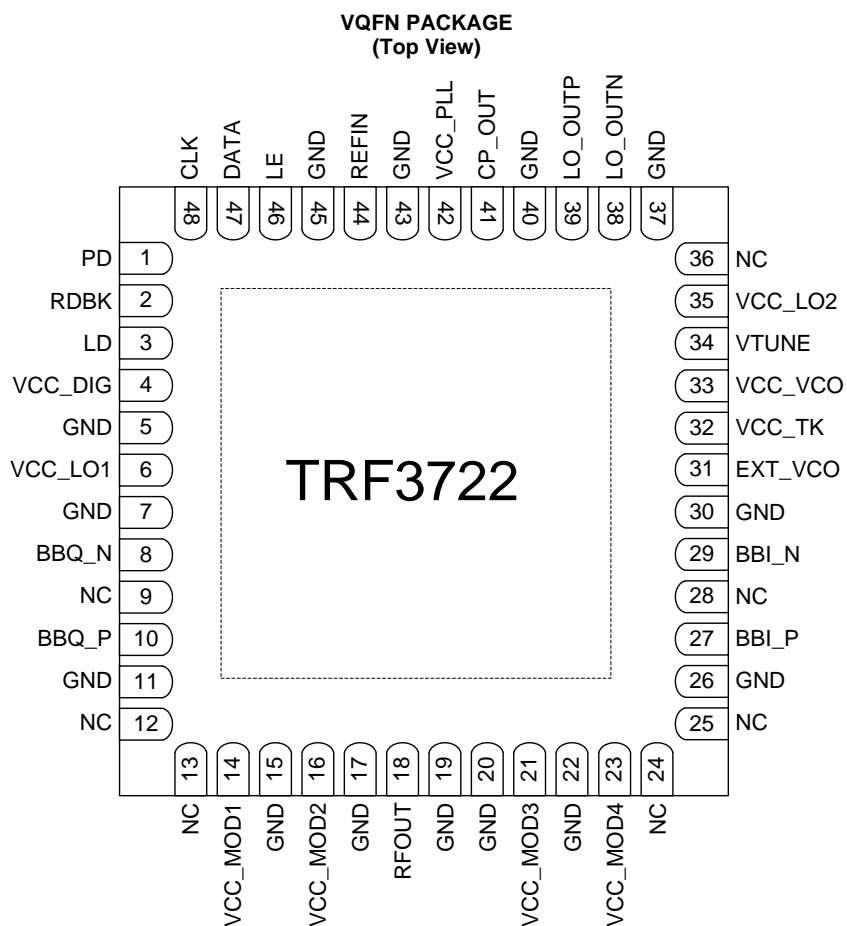

Pin Functions

Pin		I/O	DESCRIPTION
NAME	NO.		
BBI_N	29	I	BB in-phase input: negative
BBI_P	27	I	BB in-phase input: positive
BBQ_N	8	I	BB quadrature input: negative
BBQ_P	10	I	BB quadrature input: positive
CLK	48	I	Serial interface clock input; digital input
CP_OUT	41	O	Charge pump output
DATA	47	I	Serial interface data input; digital input
EXT_VCO	31	I	External local oscillator input
GND	5, 7, 11, 15, 17, 19, 20, 22, 26, 30, 37, 40, 43, 45		Ground
LD	3	O	PLL lock detect output
LE	46	I	Serial interface latch enable; digital input
LO_OUTN	38	O	Local oscillator output: negative
LO_OUTP	39	O	Local oscillator output: positive
NC	9, 12, 13, 24, 25, 36		No connect
NC	28		No connect; N/C or ground to paddle
PD	1	I	LO Div, TX Div, modulator power down (High = PD)

Pin Functions (continued)

Pin		I/O	DESCRIPTION
NAME	NO.		
RDBK	2	O	Serial interface internal registers readback output
REFIN	44	I	Reference clock input
RFOUT	18	O	RF output
VCC_DIG	4		3.3 V digital power supply
VCC_LO1	6		3.3 V TX Div power supply
VCC_LO2	35		3.3 V LO Div power supply
VCC_MOD1	14		3.3 V modulator power supply
VCC_MOD2	16		3.3 V modulator power supply
VCC_MOD3	21		3.3 V modulator power supply
VCC_MOD4	23		3.3 V modulator power supply
VCC_PLL	42		3.3 V PLL power supply
VCC_TK	32		3.3 V or 5 V VCO tank power supply
VCC_VCO	33		3.3 V VCO power supply
VTUNE	34	I	VCO control voltage input

7 Specifications

7.1 Absolute Maximum Ratings

Over operating free-air temperature range (unless otherwise noted) ⁽¹⁾

		MIN	MAX	UNIT
Supply voltage range	All VCC except VCC_TK	-0.3	+3.6	V
	VCC_TK	-0.3	+5.5	V
Digital I/O voltage range		-0.3	3.6	V
Operating junction temperature range		-40	150	°C

- (1) Stresses beyond those listed under *Absolute Maximum Ratings* may cause permanent damage to the device. These are stress ratings only, which do not imply functional operation of the device at these or any other conditions beyond those indicated under *Recommended Operating Conditions*. Exposure to absolute-maximum-rated conditions for extended periods may affect device reliability.

7.2 Handling Ratings

		MIN	MAX	UNIT	
T _{STG}	Storage temperature range	-40	150	°C	
V _{ESD}	Electrostatic discharge	Human body model (HBM), per ANSI/ESDA/JEDEC JS-001, all pins ⁽¹⁾	-2	2	kV
		Charged device model (CDM), per JEDEC specification JESD22-C101, all pins ⁽²⁾	-750	750	V

- (1) JEDEC document JEP155 states that 500-V HBM allows safe manufacturing with a standard ESD control process
 (2) JEDEC document JEP157 states that 250-V CDM allows safe manufacturing with a standard ESD control process.

7.3 Recommended Operating Conditions

Over operating free-air temperature range (unless otherwise noted)

		MIN	NOM	MAX	UNIT
V _{CC}	3.3 V power-supply voltage	3	3.3	3.6	V
	5 V or 3.3 V power-supply voltage, VCC_TK	3	3.3/5	5.5	V
T _J	Operating junction temperature range	-40		125	°C
T _A	Ambient temperature range	-40		85	°C

7.4 Thermal Information

THERMAL METRIC ⁽¹⁾		OFN	UNIT
		48 PINS	
R _{θJA}	Junction-to-ambient thermal resistance	27.5	°C/W
R _{θJC(top)}	Junction-to-case (top) thermal resistance	12.8	
R _{θJB}	Junction-to-board thermal resistance	4.3	
Ψ _{JT}	Junction-to-top characterization parameter	0.2	
Ψ _{JB}	Junction-to-board characterization parameter	4.3	
R _{θJC(bot)}	Junction-to-case (bottom) thermal resistance	0.8	

(1) For more information about traditional and new thermal metrics, see the *IC Package Thermal Metrics* application report, [SPRA953](#).

7.5 Electrical Characteristics

Over recommended operating conditions: VCC = 3.3 V, VCC_TK = 5 V, T_A = 25°C. Optimized bias settings as per [Table 16](#)

PARAMETER		TEST CONDITIONS	MIN	TYP	MAX	UNIT
DC Parameters						
I _{CC}	3.3 V Supply Current	Typical Operating Mode; LO out = Off		328 ⁽¹⁾		mA
		Typical Operating Mode; LO out = On		374		mA
I _{CC_TK}	5 V Supply Current			21		mA
P _{DISS}	Total Power Dissipation	Typical Operating Mode; LO out = Off		1.18		W
		Typical Operating Mode; LO out = On		1.34		W
		Low Power Mode (Mod); LO out = Off		0.91		W
I _{PD}	Power Down Current	Hardware Power Down		76		mA
		Serial interface Power Down		2		mA
RFOUT Frequency						
	Frequency		400		4200	MHz
IQ Modulator f_{LO} = 750 MHz						
G	Gain	Typical Operating Mode		0.8		dB
		High Gain Mode		3.6		dB
	Gain Flatness	In 300MHz bandwidth	-0.5		0.5	dB
OP1dB	Output Compression Point			10.2		dBm
OIP3	Output 3rd Order Intercept Point	F _{BB} = 4.5, 5.5 MHz		31		dBm
OIP2	Output 2nd Order Intercept Point	F _{BB} = 4.5, 5.5 MHz		62		dBm
SBS	Unadj. SideBand Suppression			-42		dBc
CF	Unadj. Carrier Feedthrough			-50		dBm
NSD _O	Output Noise Spectral Density	BB inputs terminated on 50 Ω		-159		dBm/Hz
HD2 _{LO}	LO Second Harmonic	Measured at 2 × f _{LO}		-49		dBc
HD3 _{LO}	LO Third Harmonic	Measured at 3 × f _{LO}		-47		dBc
HD2 _{BB}	Baseband Second Harmonic	Measured at f _{LO} ± 2 × f _{BB}		-72		dBc
HD3 _{BB}	Baseband Third Harmonic	Measured at f _{LO} ± 3 × f _{BB}		-70		dBc

(1) Powered down output buffer and LO divider.

Electrical Characteristics (continued)

 Over recommended operating conditions: $V_{CC} = 3.3\text{ V}$, $V_{CC_TK} = 5\text{ V}$, $T_A = 25^\circ\text{C}$. Optimized bias settings as per [Table 16](#)

PARAMETER		TEST CONDITIONS	MIN	TYP	MAX	UNIT
IQ Modulator $f_{LO} = 900\text{ MHz}$						
G	Gain	Typical Operating Mode		0.8		dB
		High Gain Mode		3.6		dB
	Gain Flatness	In 300MHz bandwidth	-0.5		0.5	dB
OP1dB	Output Compression Point			10		dBm
OIP3	Output 3rd Order Intercept Point	$F_{BB} = 4.5, 5.5\text{ MHz}$		31		dBm
OIP2	Output 2nd Order Intercept Point	$F_{BB} = 4.5, 5.5\text{ MHz}$		62.5		dBm
SBS	Unadj. Side Band Suppression			-42.5		dBc
CF	Unadj. Carrier Feed through			-50		dBm
NSD _O	Output Noise Spectral Density	BB inputs terminated on 50 Ω		-159		dBm/Hz
HD2 _{LO}	LO Second Harmonic	Measured at $2 \times f_{LO}$		-47		dBc
HD3 _{LO}	LO Third Harmonic	Measured at $3 \times f_{LO}$		-54.5		dBc
HD2 _{BB}	Baseband Second Harmonic	Measured at $f_{LO} \pm 2 \times f_{BB}$		-65.5		dBc
HD3 _{BB}	Baseband Third Harmonic	Measured at $f_{LO} \pm 3 \times f_{BB}$		-71.5		dBc
IQ Modulator $f_{LO} = 1800\text{ MHz}$						
G	Gain	Typical Operating Mode		0.3		dB
		High Gain Mode		3		dB
	Gain Flatness	In 300 MHz bandwidth	-0.5		0.5	dB
OP1dB	Output Compression Point			13		dBm
OIP3	Output 3rd Order Intercept Point	$f_{BB} = 4.5, 5.5\text{ MHz}$		29.5		dBm
OIP2	Output 2nd Order Intercept Point	$f_{BB} = 4.5, 5.5\text{ MHz}$		57		dBm
SBS	Unadj. Side Band Suppression			-54.5		dBc
CF	Unadj. Carrier Feed through			-57		dBm
NSD _O	Output Noise Spectral Density	BB inputs terminated on 50 Ω		-158		dBm/Hz
HD2 _{LO}	LO Second Harmonic	Measured at $2 \times f_{LO}$		-36.5		dBc
HD3 _{LO}	LO Third Harmonic	Measured at $3 \times f_{LO}$		-33.5		dBc
HD2 _{BB}	Baseband Second Harmonic	Measured at $f_{LO} \pm 2 \times f_{BB}$		-65.5		dBc
HD3 _{BB}	Baseband Third Harmonic	Measured at $f_{LO} \pm 3 \times f_{BB}$		-73		dBc
RL _O	RF Output Return Loss			6		dB
IQ Modulator $f_{LO} = 2150\text{ MHz}$						
G	Gain	Typical Operating Mode		0.2		dB
		High Gain Mode		3		dB
	Gain Flatness	In 300 MHz bandwidth	-0.5		0.5	dB
OP1dB	Output Compression Point			11.6		dBm
OIP3	Output 3rd Order Intercept Point	$F_{BB} = 4.5, 5.5\text{ MHz}$		30		dBm
OIP2	Output 2nd Order Intercept Point	$F_{BB} = 4.5, 5.5\text{ MHz}$		43		dBm
SBS	Unadj. Side Band Suppression			-43		dBc
CF	Unadj. Carrier Feed through			-42		dBm
NSD _O	Output Noise Spectral Density	BB inputs terminated on 50 Ω		-157		dBm/Hz
HD2 _{LO}	LO Second Harmonic	Measured at $2 \times f_{LO}$		-40		dBc
HD3 _{LO}	LO Third Harmonic	Measured at $3 \times f_{LO}$		-31		dBc
HD2 _{BB}	Baseband Second Harmonic	Measured at $f_{LO} \pm 2 \times f_{BB}$		-51		dBc
HD3 _{BB}	Baseband Third Harmonic	Measured at $f_{LO} \pm 3 \times f_{BB}$		-69		dBc

Electrical Characteristics (continued)

Over recommended operating conditions: $V_{CC} = 3.3\text{ V}$, $V_{CC_TK} = 5\text{ V}$, $T_A = 25^\circ\text{C}$. Optimized bias settings as per [Table 16](#)

PARAMETER		TEST CONDITIONS	MIN	TYP	MAX	UNIT
IQ Modulator $f_{LO} = 2700\text{ MHz}$						
G	Gain	Typical Operating Mode		0		dB
		High Gain Mode		2.4		dB
	Gain Flatness	In 300MHz bandwidth	-0.5		0.5	dB
OP1dB	Output Compression Point			10.4		dBm
OIP3	Output 3rd Order Intercept Point	$F_{BB} = 4.5, 5.5\text{ MHz}$		29.5		dBm
OIP2	Output 2nd Order Intercept Point	$F_{BB} = 4.5, 5.5\text{ MHz}$		45.5		dBm
SBS	Unadj. Side Band Suppression			-33		dBc
CF	Unadj. Carrier Feed through			-39.6		dBm
NSD _O	Output Noise Spectral Density	BB inputs terminated on 50 Ω		-156		dBm/Hz
HD2 _{LO}	LO Second Harmonic	Measured at $2 \times f_{LO}$		-29		dBc
HD3 _{LO}	LO Third Harmonic	Measured at $3 \times f_{LO}$		-37		dBc
HD2 _{BB}	Baseband Second Harmonic	Measured at $f_{LO} \pm 2 \times f_{BB}$		-53		dBc
HD3 _{BB}	Baseband Third Harmonic	Measured at $f_{LO} \pm 3 \times f_{BB}$		-68		dBc
IQ Modulator $f_{LO} = 3600\text{ MHz}$						
G	Gain	Typical Operating Mode		-2		dB
		High Gain Mode		0.4		dB
OP1dB	Output Compression Point			8.7		dBm
OIP3	Output 3rd Order Intercept Point	$F_{BB} = 4.5, 5.5\text{ MHz}$		24.5		dBm
OIP2	Output 2nd Order Intercept Point	$F_{BB} = 4.5, 5.5\text{ MHz}$		45.5		dBm
SBS	Unadj. Side Band Suppression			-31.5		dBc
CF	Unadj. Carrier Feed through			-39.5		dBm
HD2 _{LO}	LO Second Harmonic	Measured at $2 \times f_{LO}$		-28.4		dBc
HD3 _{LO}	LO Third Harmonic	Measured at $3 \times f_{LO}$		-31.5		dBc
HD2 _{BB}	Baseband Second Harmonic	Measured at $f_{LO} \pm 2 \times f_{BB}$		-55		dBc
HD3 _{BB}	Baseband Third Harmonic	Measured at $f_{LO} \pm 3 \times f_{BB}$		-65		dBc
Baseband Inputs						
V_{CM}	Common Mode Voltage	Baseband I/Q input	0	0.25	0.5	V
BW_{BB}	Baseband Bandwidth	1 dB Bandwidth		900		MHz
Z_{inBB}	Baseband Input Impedance	Resistance		5		k Ω
		Capacitance		4		pF
Reference Oscillator Parameters						
F_{ref}	Reference Frequency	Max		350		MHz
	Reference Input Sensitivity		0.2		3.3	V_{PP}
Z_{inref}	Reference Input Impedance	Parallel capacitance		2		pF
		Parallel resistance		2.2		k Ω
PFD, CP						
F_{PFD}	PFD Frequency	Max, refer to the Application Information			65	MHz
I_{CP_OUT}	Charge Pump Current	Max		1.94		mA
	In-band Normalized PN Floor	Integer Mode		-221		dBc/Hz

Electrical Characteristics (continued)

 Over recommended operating conditions: VCC = 3.3 V, VCC_TK = 5 V, T_A = 25°C. Optimized bias settings as per [Table 16](#)

PARAMETER		TEST CONDITIONS	MIN	TYP	MAX	UNIT
VCO						
f _{VCO}	VCO Frequency range		2050		4100	MHz
K _V	VCO gain	VTUNE = 1.1 V		30		MHz/V
PN	VCO Open Loop Phase Noise; f _{VCO} = 3600 MHz; TX Div = Div-by-1; f _{OUT} = 3600 MHz VTUNE = 1.1 V	10 kHz		-74		dBc/Hz
		100 kHz		-109		
		1 MHz		-135		
		10 MHz		-152		
		40 MHz		-156		
	VCO Open Loop Phase Noise; f _{VCO} = 3600 MHz; TX Div = Div-by-2; f _{OUT} = 1800 MHz; VTUNE = 1.1 V	10 kHz		-80		dBc/Hz
		100 kHz		-115		
		1 MHz		-141		
		10 MHz		-156		
		40 MHz		-158		
LO Output						
f _{OUT}	Output frequency range	Divide by 1	2050		4100	MHz
		Divide by 2	1025		2050	
		Divide by 4	512.5		1025	
		Divide by 8	256.25		512.5	
P _{LO}	Output power	SE at 1800 MHz, OUTBUF_BIAS = 2		1		dBm
	External VCO input Frequency Range		250		4200	MHz
	External VCO Input Level		-10	0	10	dBm
Close Loop PLL or VCO						
	Integrated Phase Noise	Frac-N; PFD = 15.36 MHz; f _{OUT} = 3532.89 MHz; Integration BW = 1 kHz to 10 MHz; SSB		-45.2		dB
		Int-N; PFD = 2.56 MHz; f _{OUT} = 1799.68 MHz; Integration BW = 500 Hz to 20 MHz; SSB		-49.8		dB
	VCO Close Loop Phase Noise; f _{VCO} = 3600 MHz; TX DIV = Div-by-2; f _{OUT} = 1800 MHz; Integer Mode, PFD = 2.56MHz	10 kHz		-96		dBc/Hz
		100 kHz		-114		
		1 MHz		-140		
		10 MHz		-156		
		40 MHz		-158		
Digital Interface						
V _{IH}	High Level Input Voltage		2	3.3		V
V _{IL}	Low Level Input Voltage		0		0.8	V
V _{OH}	High Level Output Voltage	Referenced to VCC_DIG	0.8 x VCC			V
V _{OL}	Low Level Output Voltage	Referenced to VCC_DIG			0.2 x VCC	V

7.6 Typical Characteristics

7.6.1 Modulator Output Spectrum

Graphical illustration of the modulator output spectrum with two tones is shown in Figure 1.

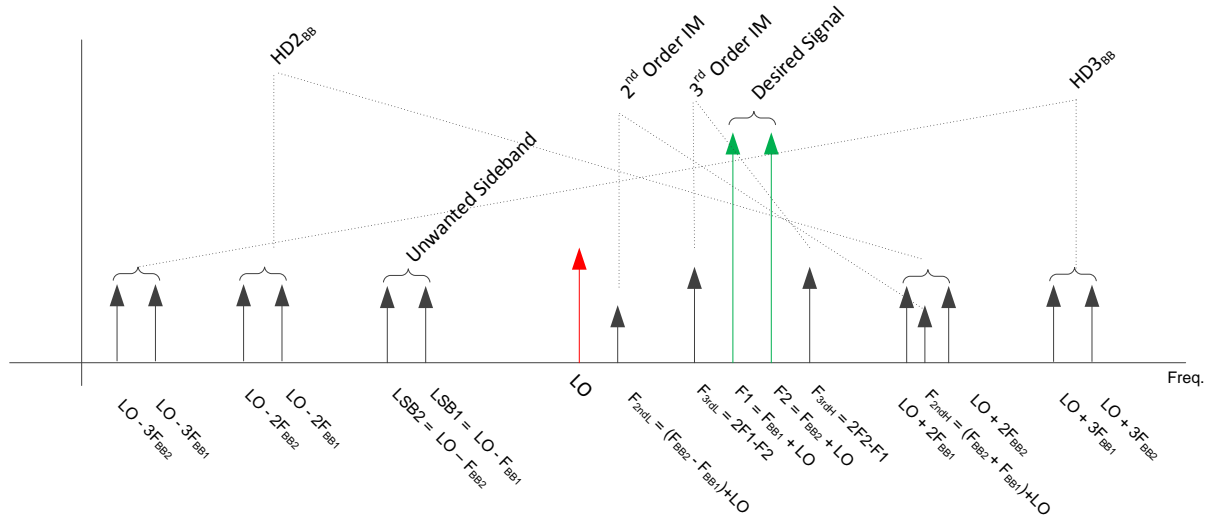

- F_{BBn} = Baseband Frequency
- F_n = RF Frequency
- $F_{3rdH/L}$ = 3rd Order Intermodulation Product Frequency (High Side / Low Side)
- $F_{2ndH/L}$ = 2nd Order Intermodulation Product Frequency (High Side / Low Side)
- LO = Local Oscillator Frequency
- LSBn = Lower Sideband Frequency
- HD2_{BB} = Baseband second harmonic (High Side / Low Side)
- HD3_{BB} = Baseband third harmonic (High Side / Low Side)

Figure 1. Graphical Illustration of Modulator Output Spectrum

7.7 Typical Characteristics - Output Power

Unless specified all plots were created using TRF3722EVM, $V_{CC} = 3.3\text{ V}$, $V_{CC_TK} = 5\text{ V}$, $T_A = 25^\circ\text{C}$, I/Q frequency (f_{BB}) 4.5 MHz and 5.5 MHz, 500 mV_{PP}, $V_{CM} = 0.25\text{ V}$, and 4.7 pF series capacitor at RFOUT. Optimized bias settings as per Table 16. Total P_{OUT} is two tones combined power.

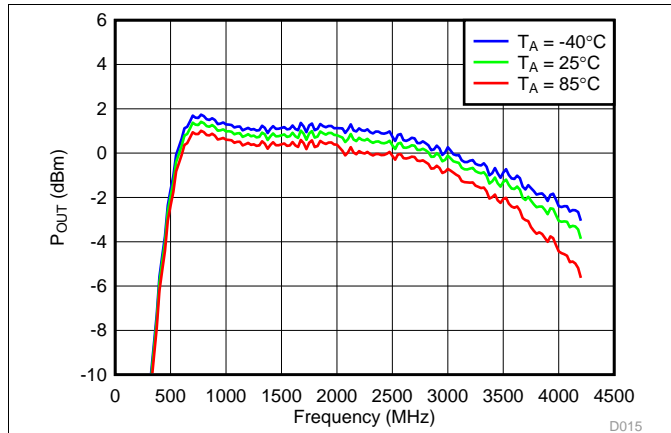

Figure 2. Total P_{OUT} vs Temperature, Typical operating mode.

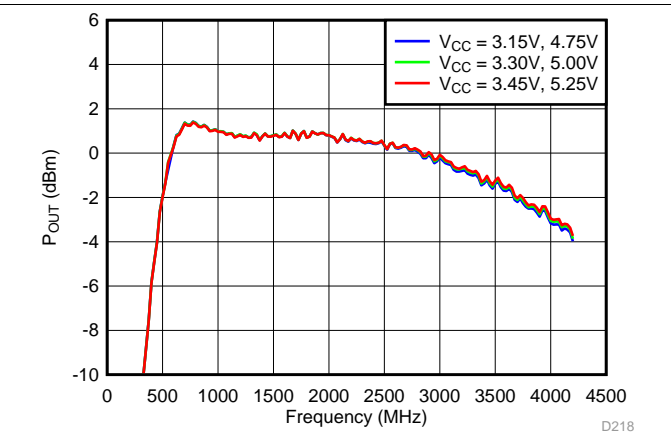

Figure 3. Total P_{OUT} vs Supply, Typical Operating Mode

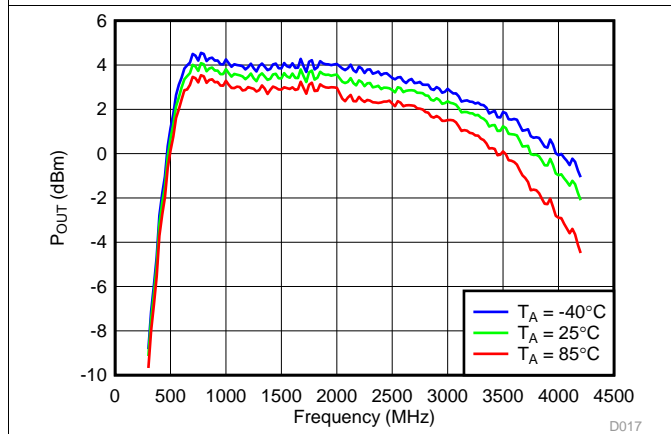

Figure 4. Total P_{OUT} vs Temperature, High Gain Mode

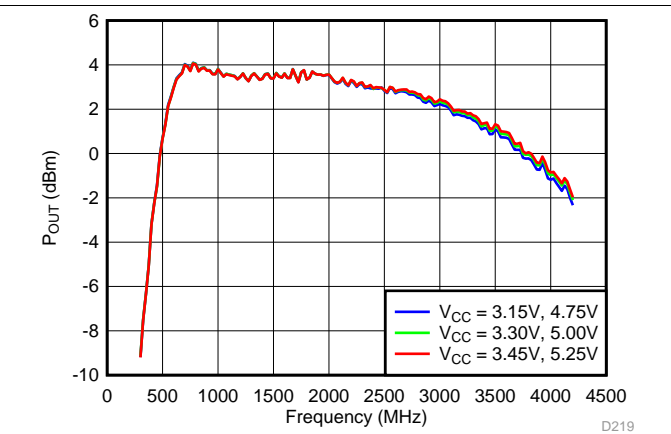

Figure 5. Total P_{OUT} vs Supply, High Gain Mode

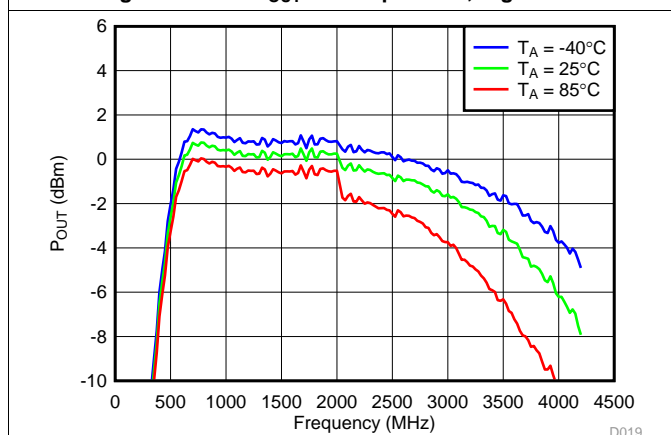

Figure 6. Total P_{OUT} vs Temperature, Low Power Mode

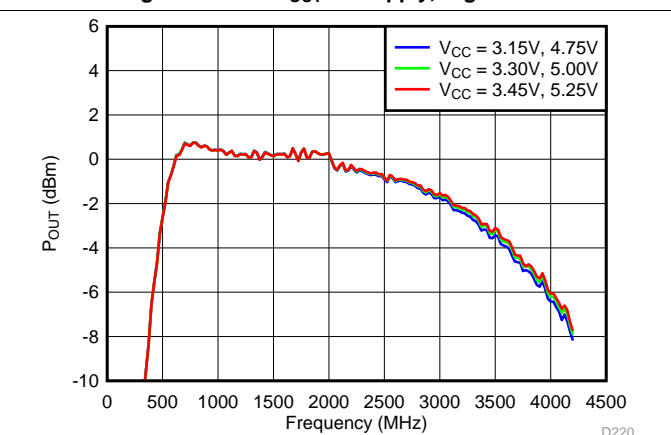

Figure 7. Total P_{OUT} vs Supply, Low Power Mode

7.8 Typical Characteristics - Gain

Unless specified all plots were created using TRF3722EVM, $V_{CC} = 3.3\text{ V}$, $V_{CC_TK} = 5\text{ V}$, $T_A = 25^\circ\text{C}$, I/Q frequency (f_{BB}) 4.5 MHz and 5.5 MHz, $V_{CM} = 0.25\text{ V}$, and 4.7 pF series capacitor at RFOUT. Optimized bias settings as per [Table 16](#).

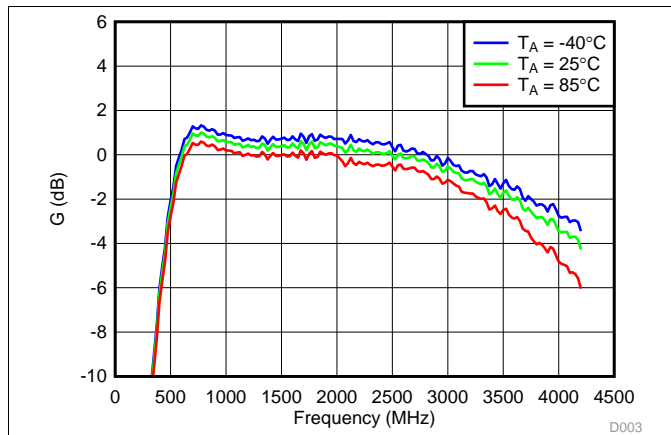

Figure 8. Voltage Gain vs Temperature, Typical Operating Mode

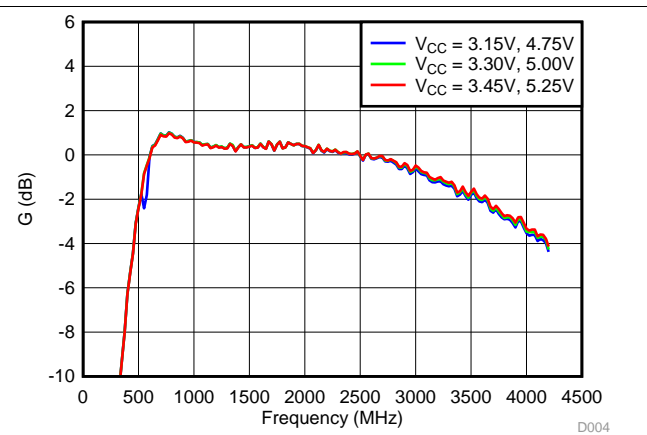

Figure 9. Voltage Gain vs Supply, Typical Operating Mode

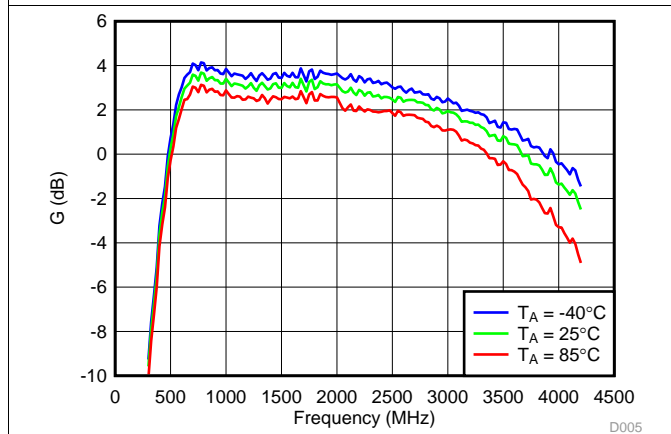

Figure 10. Voltage Gain vs Temperature, High Gain Mode

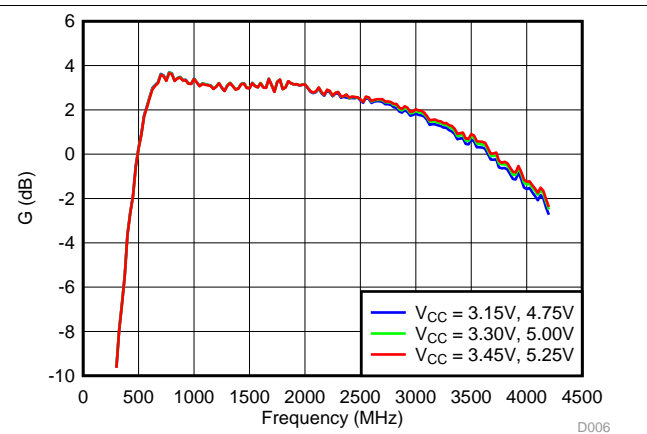

Figure 11. Voltage Gain vs Supply, High Gain Mode

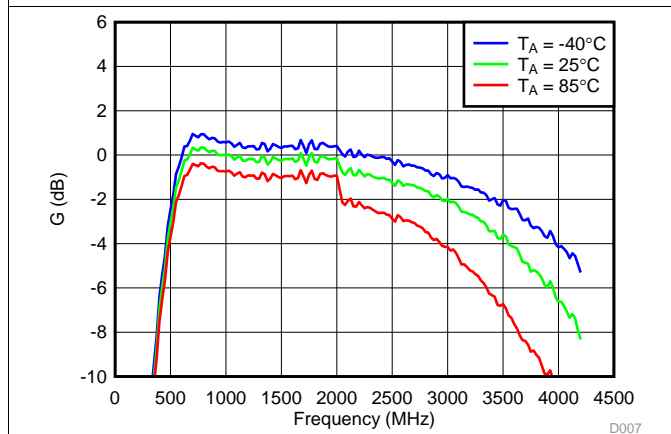

Figure 12. Voltage Gain vs Temperature, Low Power Mode

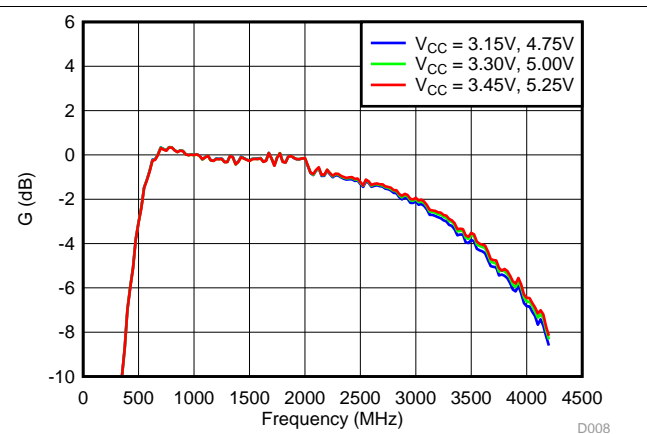

Figure 13. Voltage Gain vs Supply, Low Power Mode

7.9 Typical Characteristics - OIP3

Unless specified all plots were created using TRF3722EVM, $V_{CC} = 3.3\text{ V}$, $V_{CC_TK} = 5\text{ V}$, $T_A = 25^\circ\text{C}$, I/Q frequency (f_{BB}) 4.5 MHz and 5.5 MHz, $V_{CM} = 0.25\text{ V}$, and 4.7 pF series capacitor at RFOUT. Optimized bias settings as per Table 16. Reported OIP3 is minimum of low side and high side.

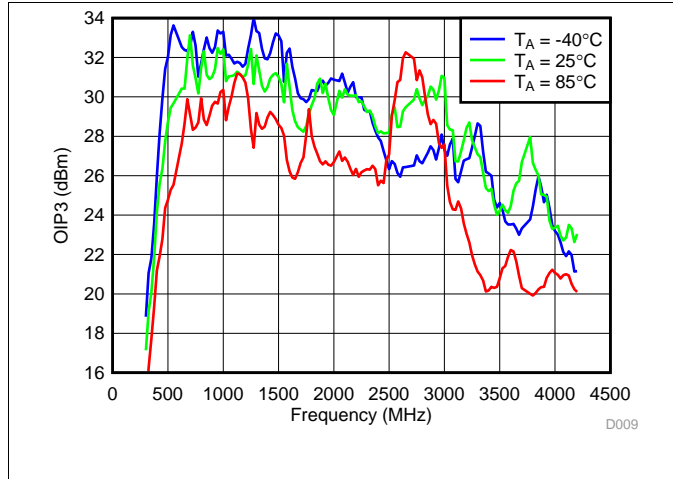

Figure 14. OIP3 vs Temperature, Typical Operating Mode

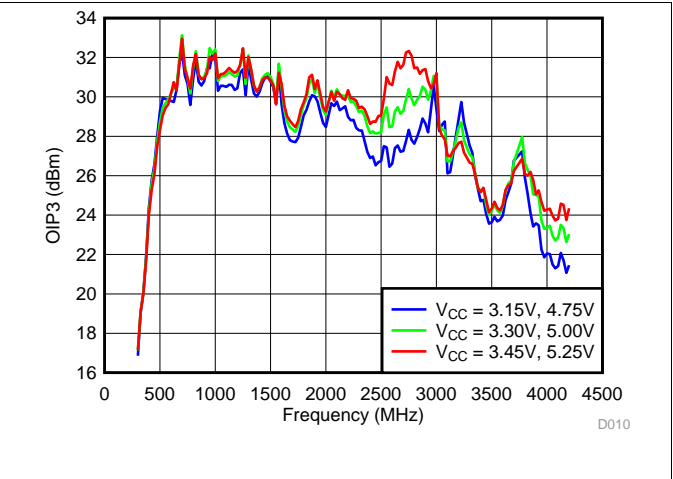

Figure 15. OIP3 vs Supply, Typical Operating Mode

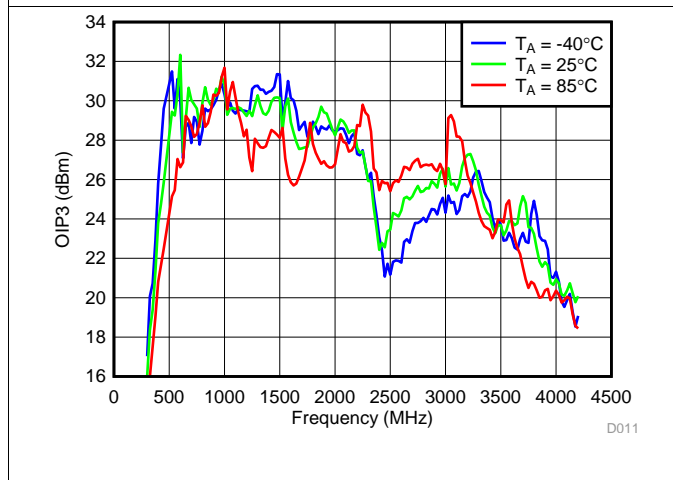

Figure 16. OIP3 vs Temperature, High Gain Mode

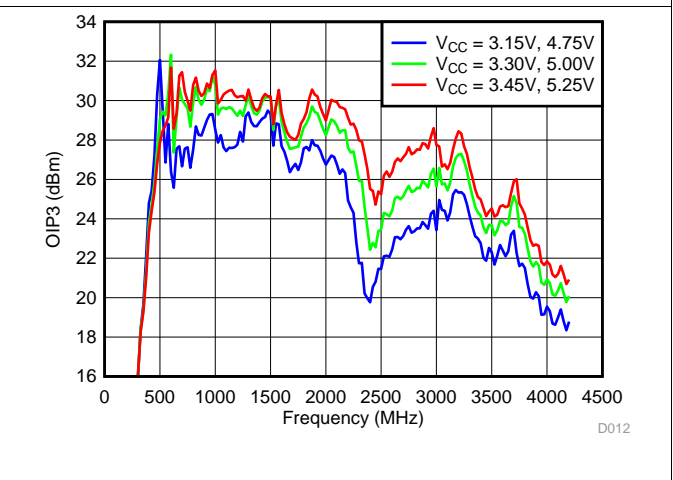

Figure 17. OIP3 vs Supply, High Gain Mode

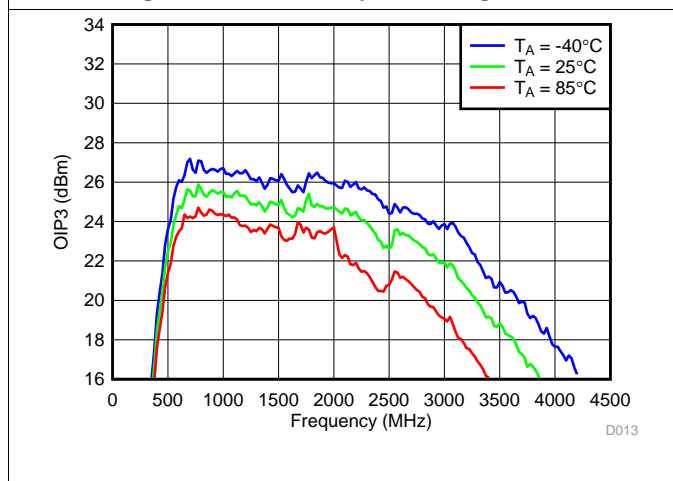

Figure 18. OIP3 vs Temperature, Low Power Mode

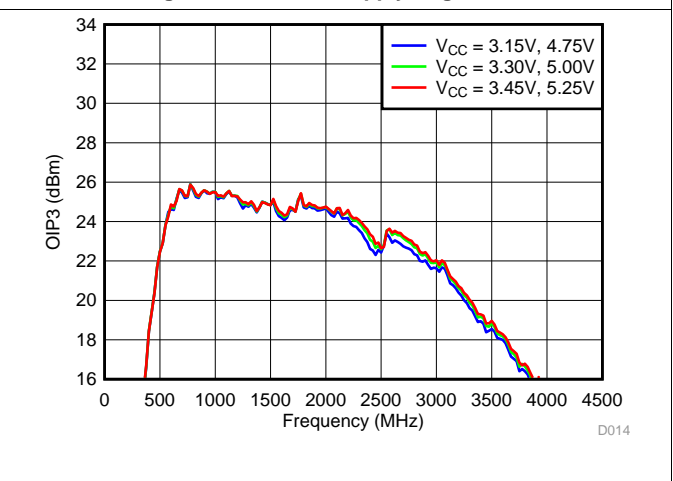

Figure 19. OIP3 vs Supply, Low Power Mode

7.10 Typical Characteristics - OIP2

Unless specified all plots were created using TRF3722EVM, $V_{CC} = 3.3\text{ V}$, $V_{CC_TK} = 5\text{ V}$, $T_A = 25^\circ\text{C}$, I/Q frequency (f_{BB}) 4.5 MHz and 5.5 MHz, $V_{CM} = 0.25\text{ V}$, and 4.7 pF series capacitor at RFOUT. Optimized bias settings as per Table 16. Reported OIP2 is minimum of low side and high side.

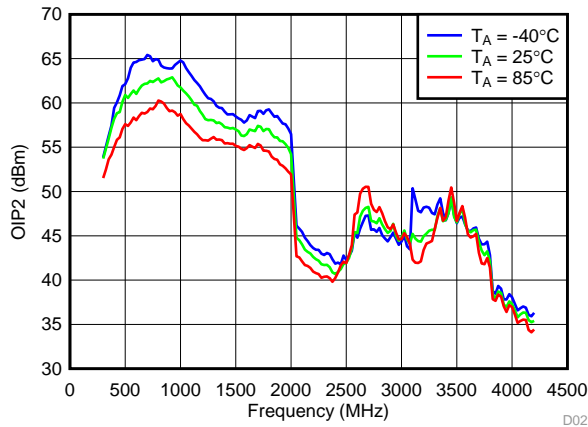

Figure 20. OIP2 vs Temperature, Typical Operating Mode

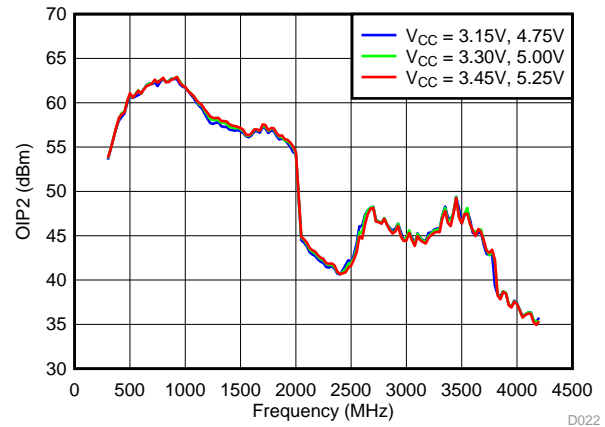

Figure 21. OIP2 vs Supply, Typical Operating Mode

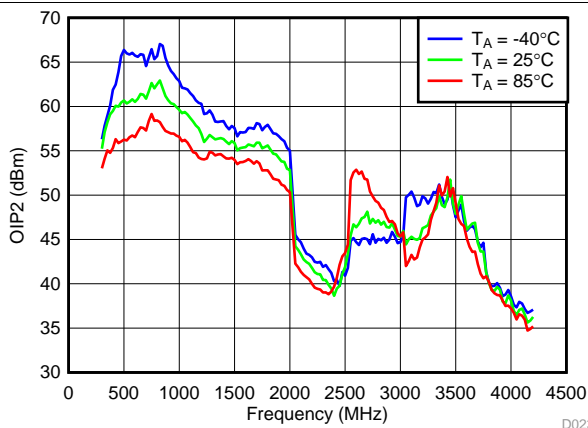

Figure 22. OIP2 vs Temperature, High Gain Mode

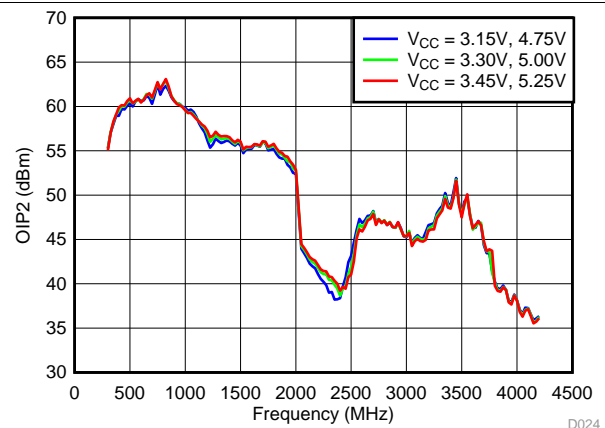

Figure 23. OIP2 vs Supply, High Gain Mode

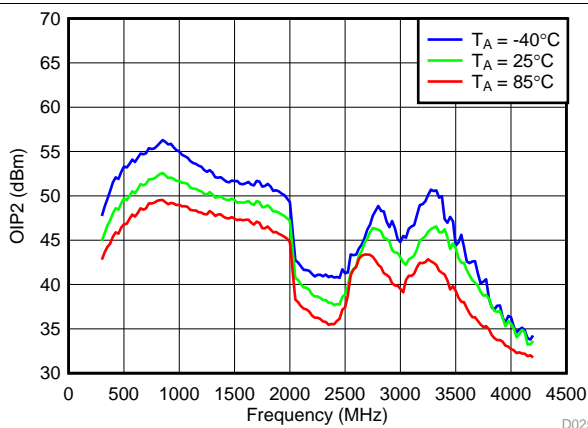

Figure 24. OIP2 vs Temperature, Low Power Mode

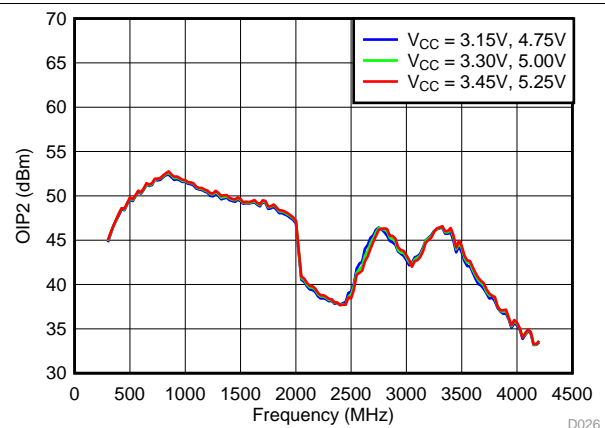

Figure 25. OIP2 vs Supply, Low Power Mode

7.11 Typical Characteristics - OP1dB

Unless specified all plots were created using TRF3722EVM, $V_{CC} = 3.3\text{ V}$, $V_{CC_TK} = 5\text{ V}$, $T_A = 25^\circ\text{C}$, I/Q frequency (f_{BB}) 5 MHz, $V_{CM} = 0.25\text{ V}$, and 4.7 pF series capacitor at RFOUT. Optimized bias settings as per [Table 16](#).

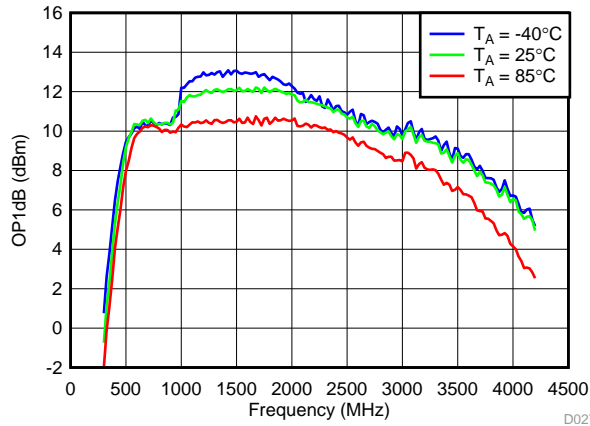

Figure 26. OP1dB vs Temperature, Typical Operating Mode

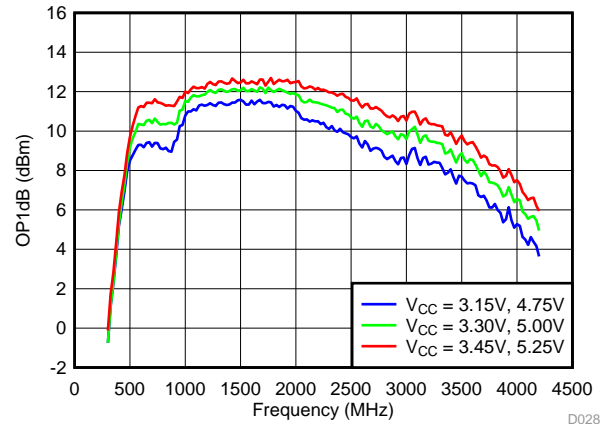

Figure 27. OP1dB vs Supply, Typical Operating Mode

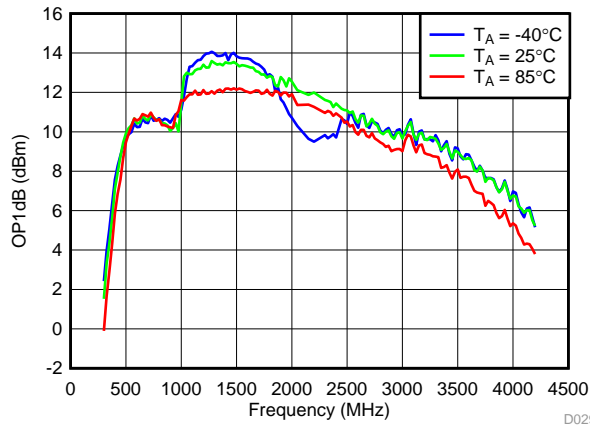

Figure 28. OP1dB vs Temperature, High Gain Mode

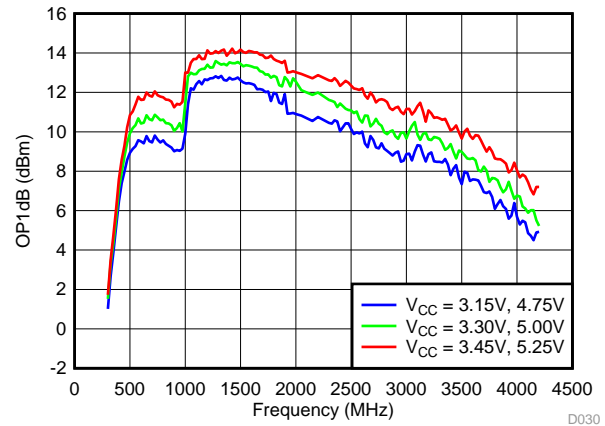

Figure 29. OP1dB vs Supply, High Gain Mode

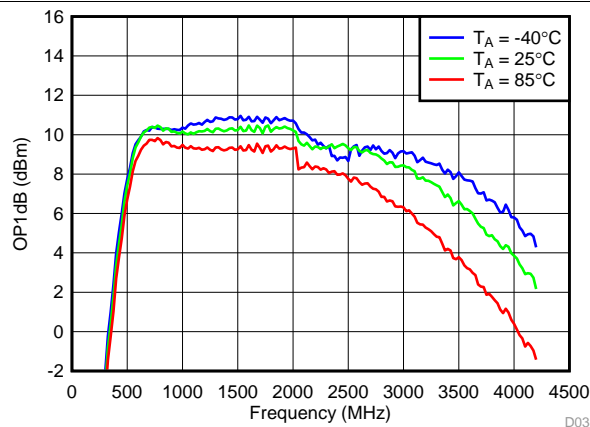

Figure 30. OP1dB vs Temperature, Low Power Mode

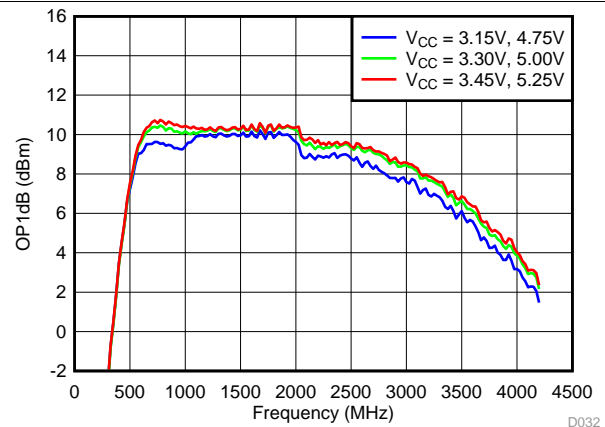

Figure 31. OP1dB vs Supply, Low Power Mode

7.12 Typical Characteristics - Noise

Unless specified all plots were created using TRF3722EVM, $V_{CC} = 3.3\text{ V}$, $V_{CC_TK} = 5\text{ V}$, $T_A = 25^\circ\text{C}$, BB inputs terminated to 50 ohms and 4.7 pF series capacitor at RFOUT. Optimized bias settings as per Table 16.

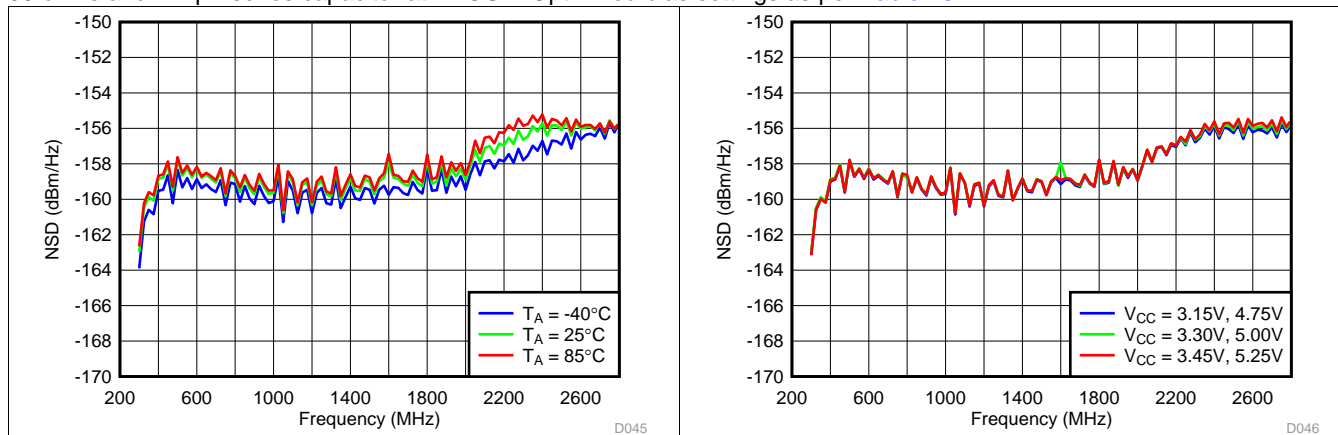

Figure 32. Noise vs Temperature, Typical Operating Mode

Figure 33. Noise vs Supply, Typical Operating Mode

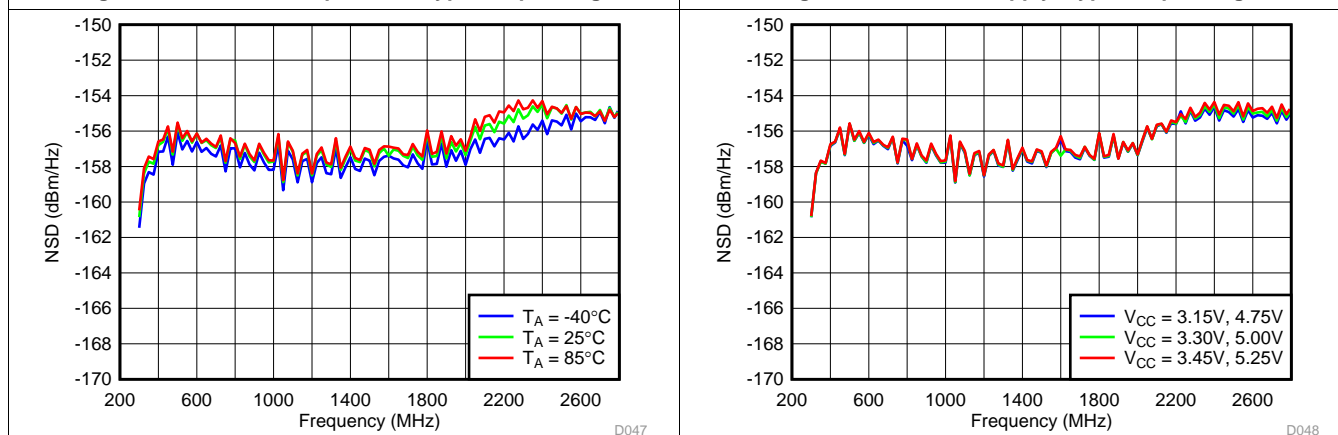

Figure 34. Noise vs Temperature, High Gain Mode

Figure 35. Noise vs Supply, High Gain Mode

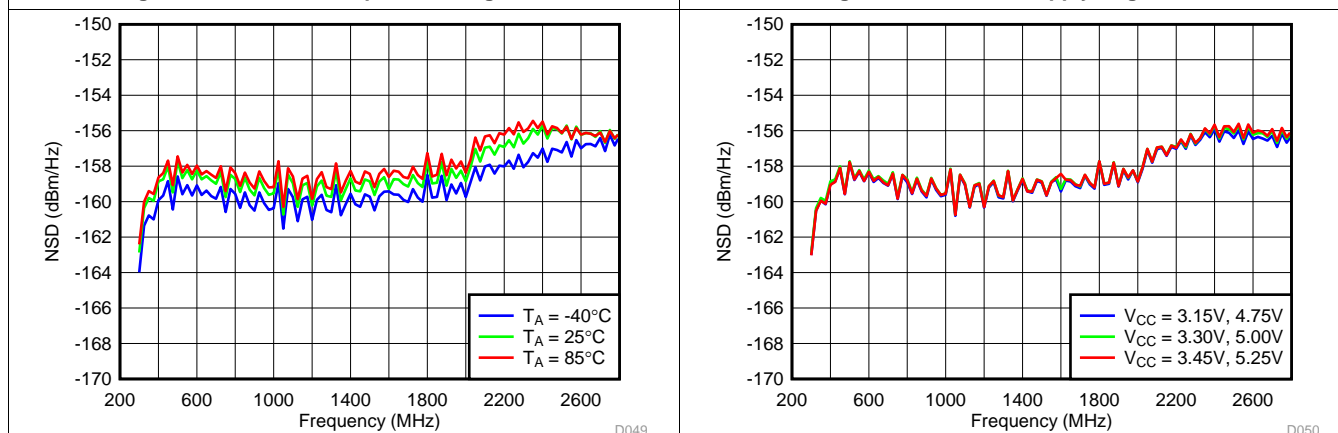

Figure 36. Noise vs Temperature, Low Power Mode

Figure 37. Noise vs Supply, Low Power Mode

7.13 Typical Characteristics - Unadjusted CF

Unless specified all plots were created using TRF3722EVM, $V_{CC} = 3.3\text{ V}$, $V_{CC_TK} = 5\text{ V}$, $T_A = 25^\circ\text{C}$, I/Q frequency (f_{BB}) 4.5 MHz and 5.5 MHz, $V_{CM} = 0.25\text{ V}$, and 4.7 pF series capacitor at RFOUT. Optimized bias settings as per Table 16.

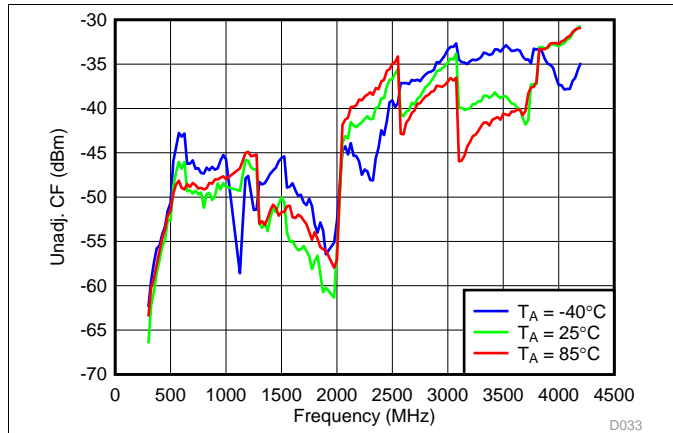

Figure 38. Unadjustable CF vs Temperature, Typical Operating Mode

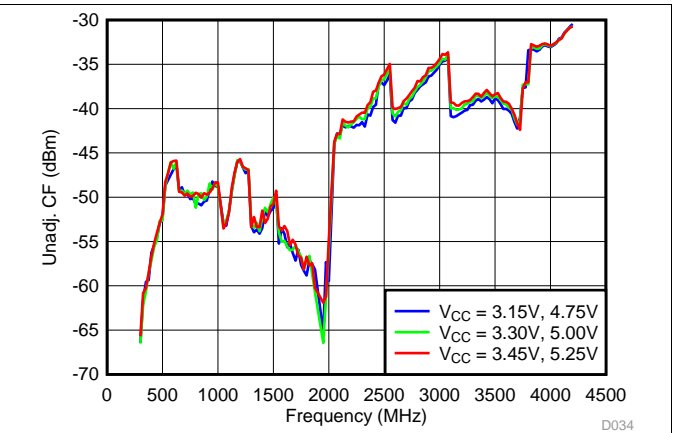

Figure 39. Unadjustable CF vs Supply, Typical Operating Mode

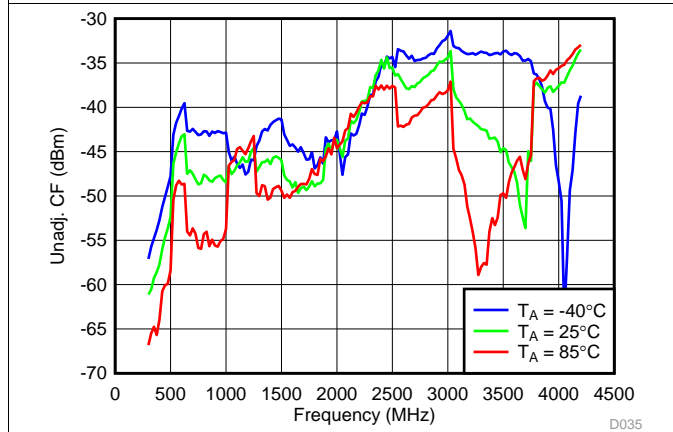

Figure 40. Unadjustable CF vs Temperature, High Gain Mode

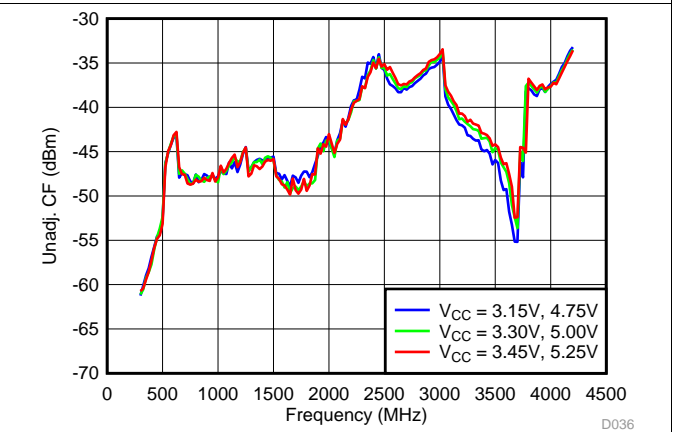

Figure 41. Unadjustable CF vs Supply, High Gain Mode

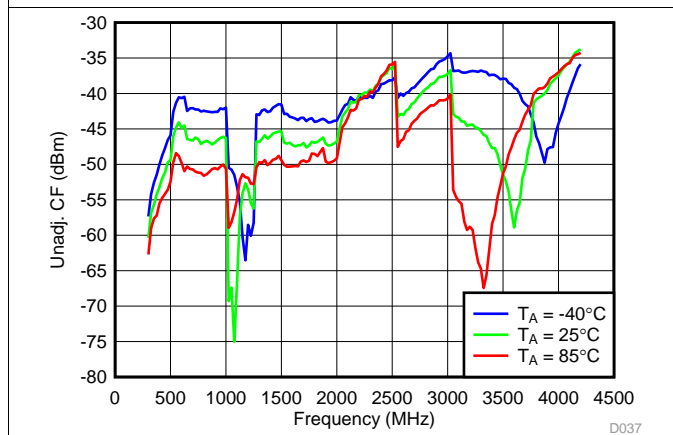

Figure 42. Unadjustable CF vs Temperature, Low Power Mode

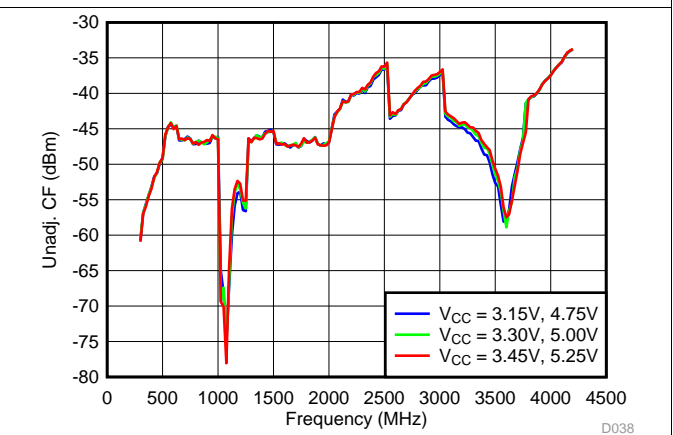

Figure 43. Unadjustable CF vs Supply, Low Power Mode

7.14 Typical Characteristics - Unadjusted SBS

Unless specified all plots were created using TRF3722EVM, $V_{CC} = 3.3\text{ V}$, $V_{CC_TK} = 5\text{ V}$, and $T_A = 25^\circ\text{C}$, I/Q frequency (f_{BB}) 4.5 MHz and 5.5 MHz, $V_{CM} = 0.25\text{ V}$, and 4.7 pF series capacitor at RFOUT. Optimized bias settings as per Table 16.

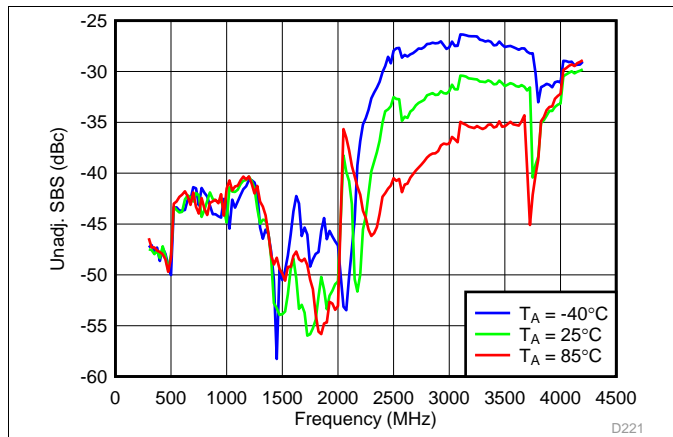

Figure 44. Unadjustable SBS vs Temperature, Typical Operating Mode

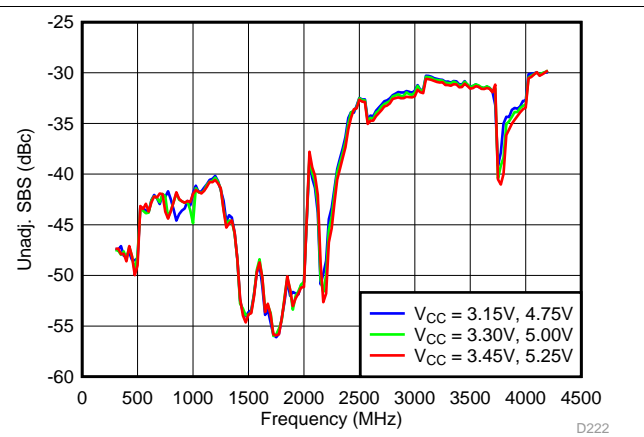

Figure 45. Unadjustable SBS vs Supply, Typical Operating Mode

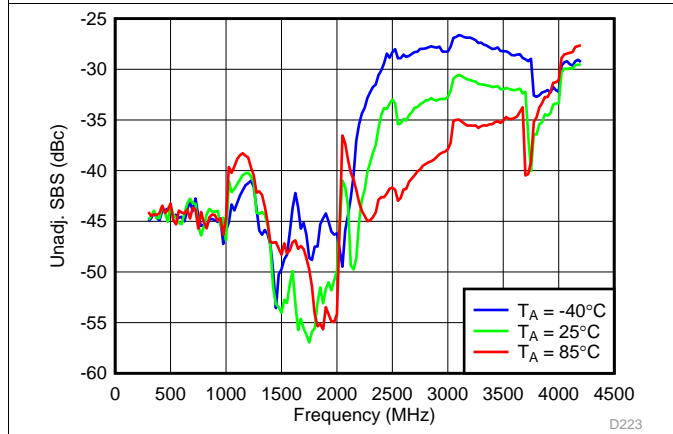

Figure 46. Unadjustable SBS vs Temperature, High Gain Mode

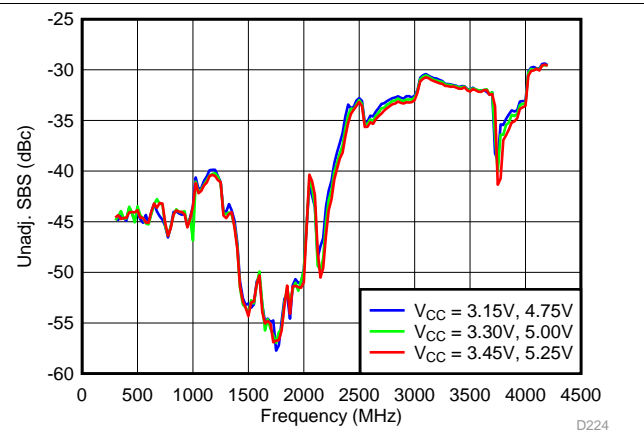

Figure 47. Unadjustable SBS vs Supply, High Gain Mode

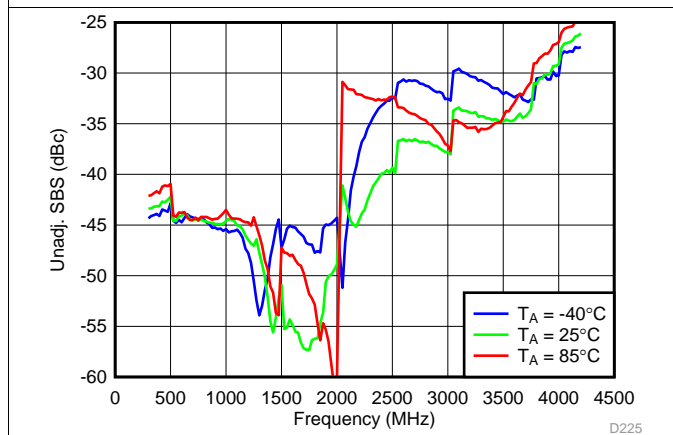

Figure 48. Unadjustable SBS vs Temperature, Low Power Mode

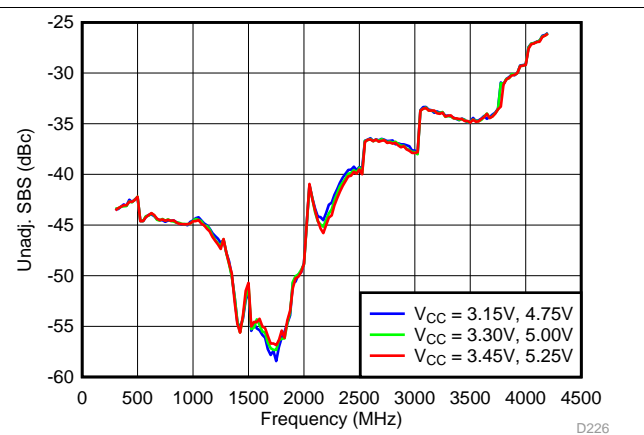

Figure 49. Unadjustable SBS vs Supply, Low Power Mode

7.15 Typical Characteristics - LO Harmonic

Unless specified all plots were created using TRF3722EVM, $V_{CC} = 3.3\text{ V}$, $V_{CC_TK} = 5\text{ V}$, and $T_A = 25^\circ\text{C}$, I/Q frequency (f_{BB}) 4.5 MHz and 5.5 MHz, $V_{CM} = 0.25\text{ V}$, and 4.7 pF series capacitor at RFOUT. Optimized bias settings as per Table 16.

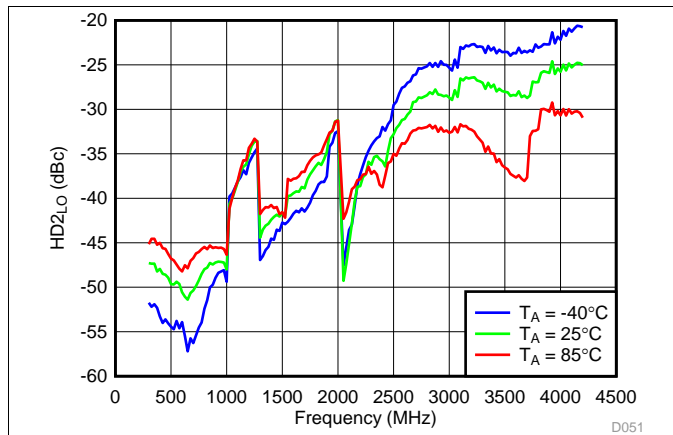

Figure 50. LO Second Harmonic vs Temperature, Typical Operating Mode

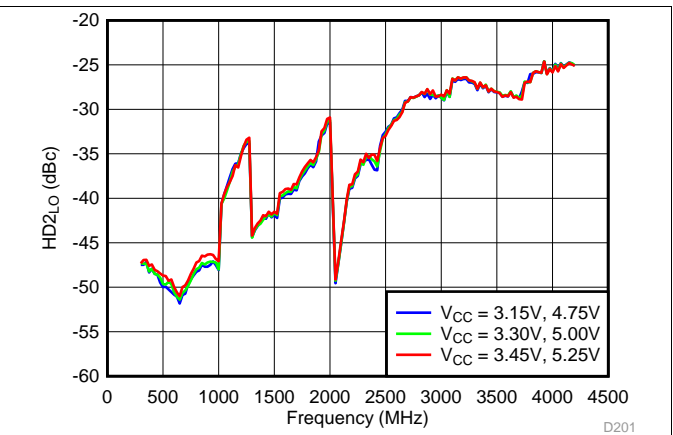

Figure 51. LO Second Harmonic vs Supply, Typical Operating Mode

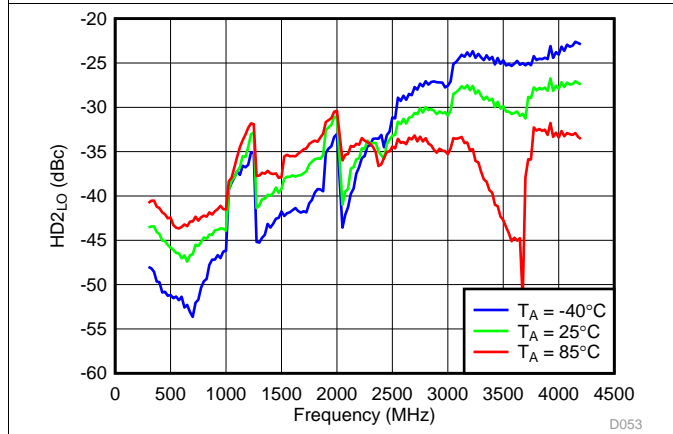

Figure 52. LO Second Harmonic vs Temperature, High Gain Mode

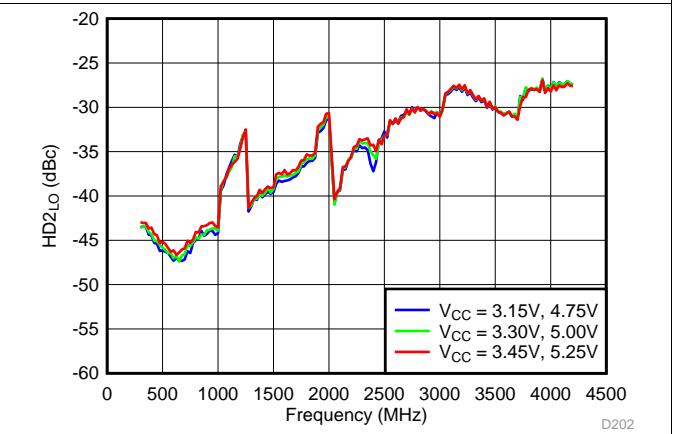

Figure 53. LO Second Harmonic vs Supply, High Gain Mode

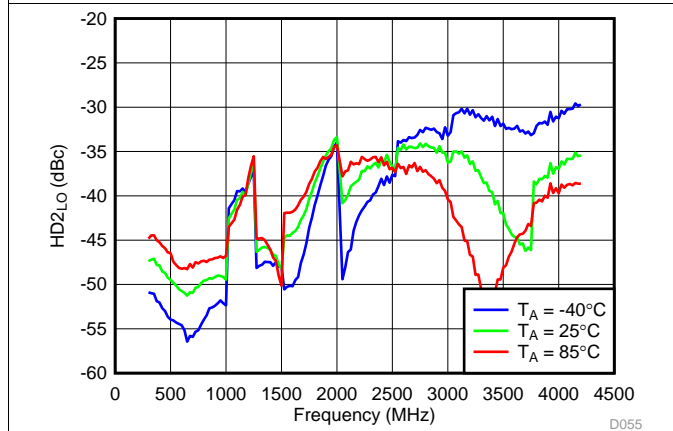

Figure 54. LO Second Harmonic vs Temperature, Low Power Mode

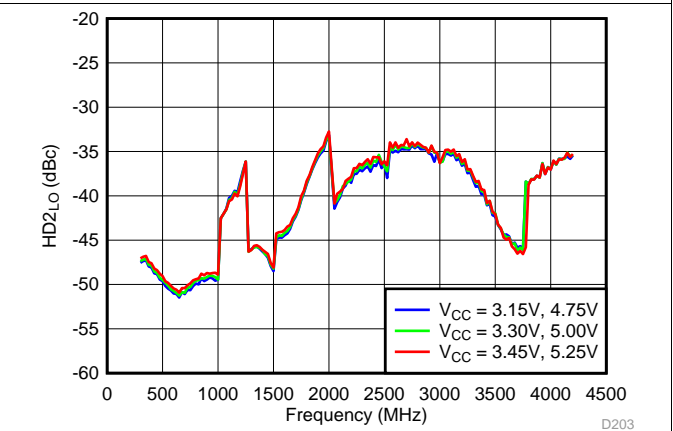

Figure 55. LO Second Harmonic vs Supply, Low Power Mode

Typical Characteristics - LO Harmonic (continued)

Unless specified all plots were created using TRF3722EVM, $V_{CC} = 3.3\text{ V}$, $V_{CC_TK} = 5\text{ V}$, and $T_A = 25^\circ\text{C}$, I/Q frequency (f_{BB}) 4.5 MHz and 5.5 MHz, $V_{CM} = 0.25\text{ V}$, and 4.7 pF series capacitor at RFOUT. Optimized bias settings as per Table 16.

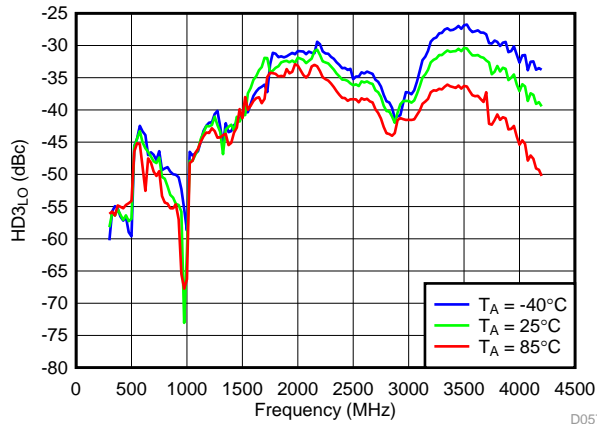

Figure 56. LO Third Harmonic vs Temperature, Typical Operating Mode

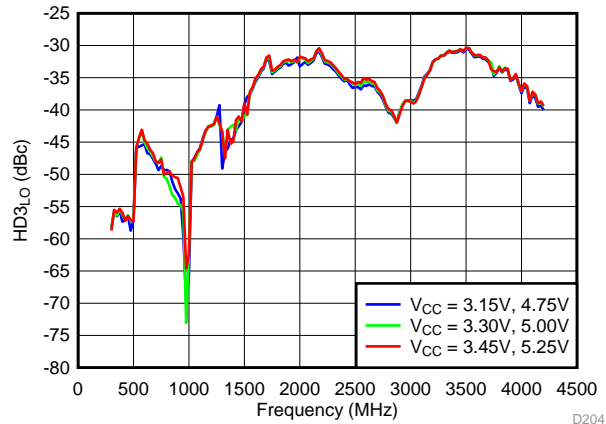

Figure 57. LO Third Harmonic vs Supply, Typical Operating Mode

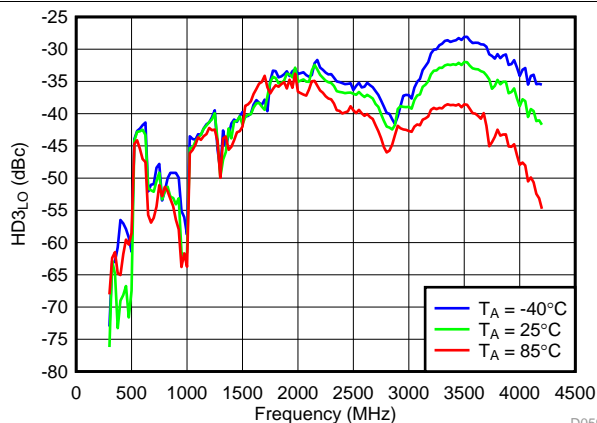

Figure 58. LO Third Harmonic vs Temperature, High Gain Mode

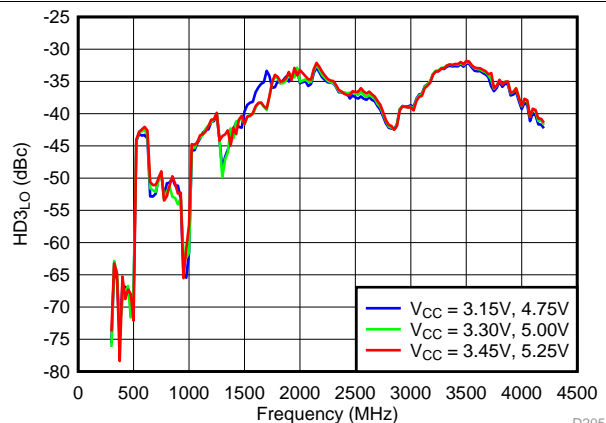

Figure 59. LO Third Harmonic vs Supply, High Gain Mode

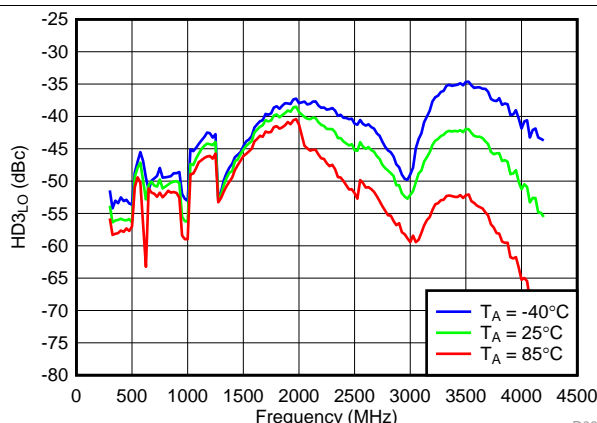

Figure 60. LO Third Harmonic vs Temperature, Low Power Mode

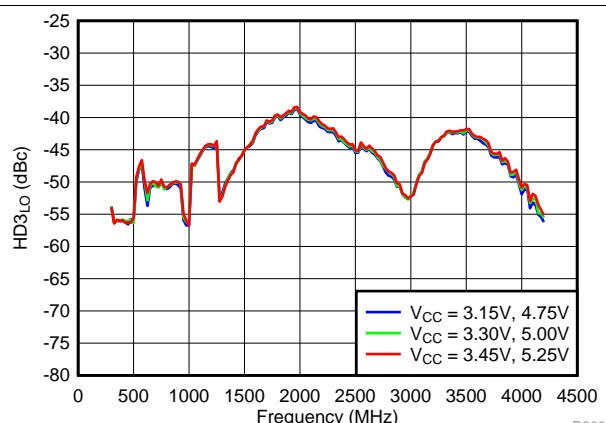

Figure 61. LO Third Harmonic vs Supply, Low Power Mode

7.16 Typical Characteristics - BB Harmonic

Unless specified all plots were created using TRF3722EVM, $V_{CC} = 3.3\text{ V}$, $V_{CC_TK} = 5\text{ V}$, and $T_A = 25^\circ\text{C}$, I/Q frequency (f_{BB}) 4.5 MHz and 5.5 MHz, $V_{CM} = 0.25\text{ V}$, and 4.7 pF series capacitor at RFOUT. Optimized bias settings as per Table 16. Reported BB harmonic is from (f_{BB}) 4.5MHz.

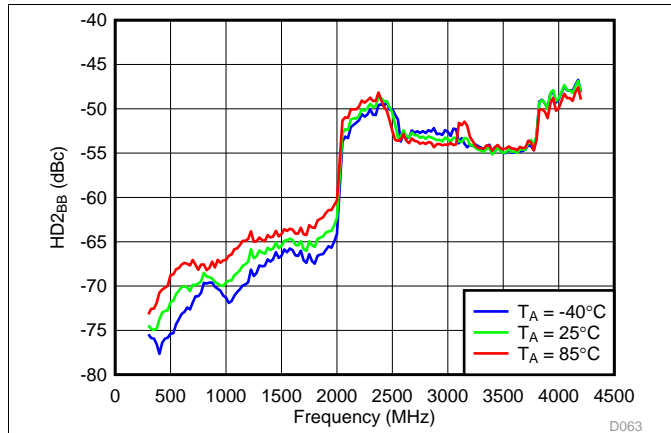

Figure 62. BB-HD2 vs Temperature, Typical Operating Mode

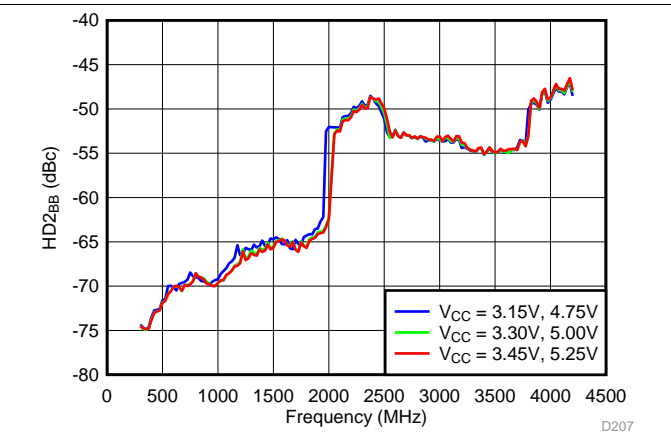

Figure 63. BB-HD2 vs Supply, Typical Operating Mode

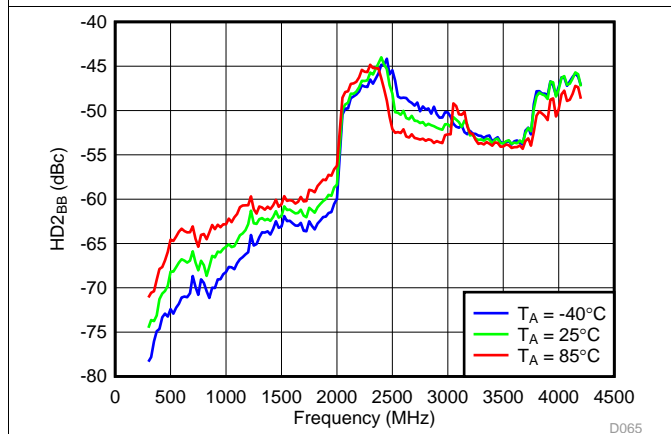

Figure 64. BB-HD2 vs Temperature, High Gain Mode

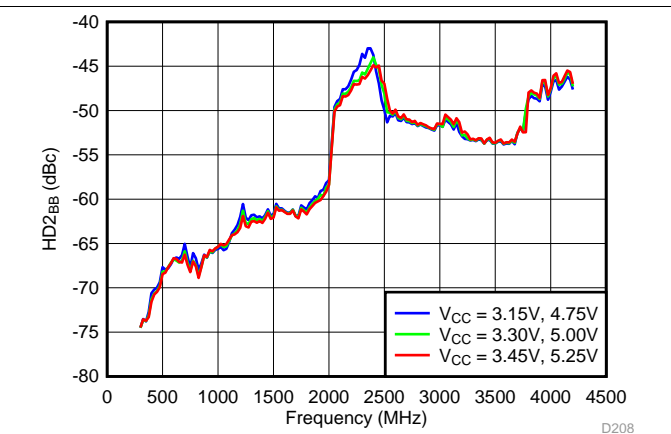

Figure 65. BB-HD2 vs Supply, High Gain Mode

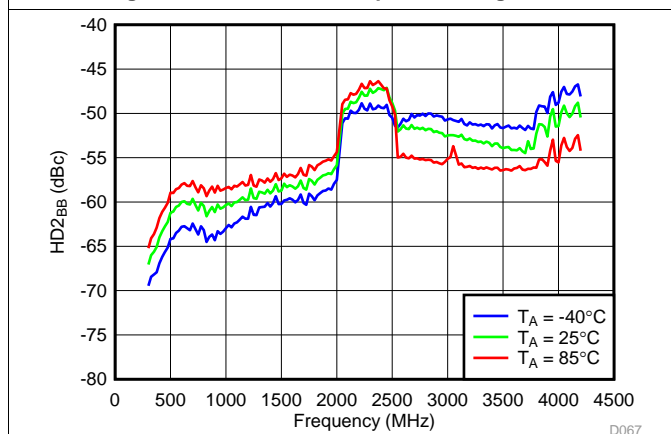

Figure 66. BB-HD2 vs Temperature, Low Power Mode

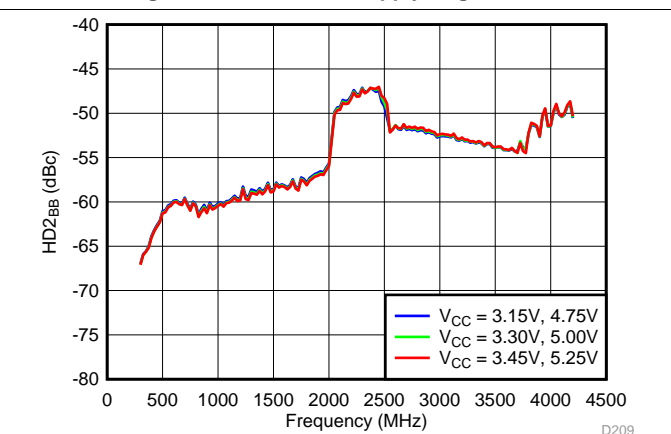

Figure 67. BB-HD2 vs Supply, Low Power Mode

Typical Characteristics - BB Harmonic (continued)

Unless specified all plots were created using TRF3722EVM, $V_{CC} = 3.3\text{ V}$, $V_{CC_TK} = 5\text{ V}$, and $T_A = 25^\circ\text{C}$, I/Q frequency (f_{BB}) 4.5 MHz and 5.5 MHz, $V_{CM} = 0.25\text{ V}$, and 4.7 pF series capacitor at RFOUT. Optimized bias settings as per Table 16. Reported BB harmonic is from (f_{BB}) 4.5MHz.

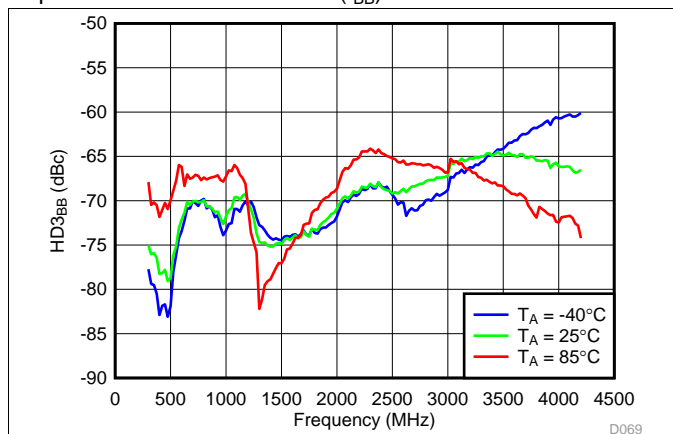

Figure 68. BB-HD3 vs Temperature, Typical Operating Mode

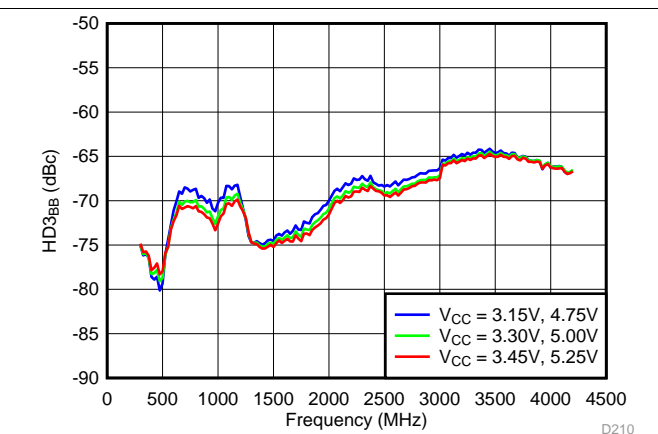

Figure 69. BB-HD3 vs Supply, Typical Operating Mode

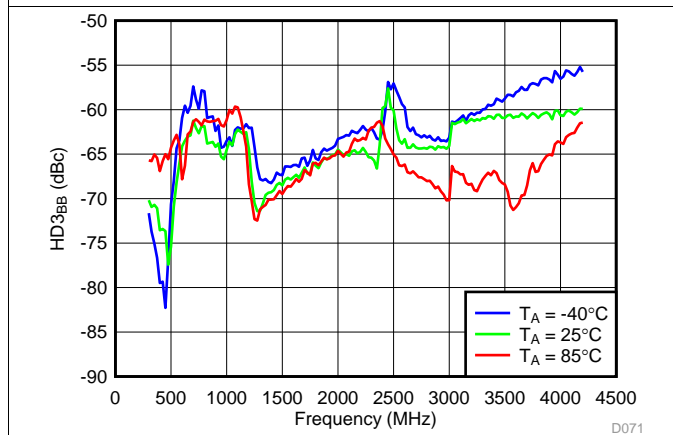

Figure 70. BB-HD3 vs Temperature, High Gain Mode

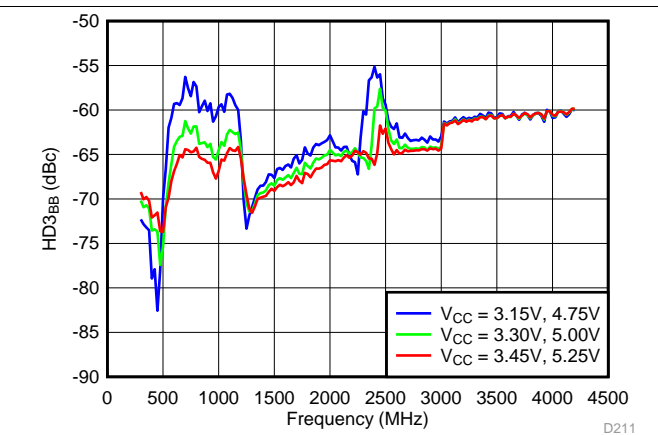

Figure 71. BB-HD3 vs Supply, High Gain Mode

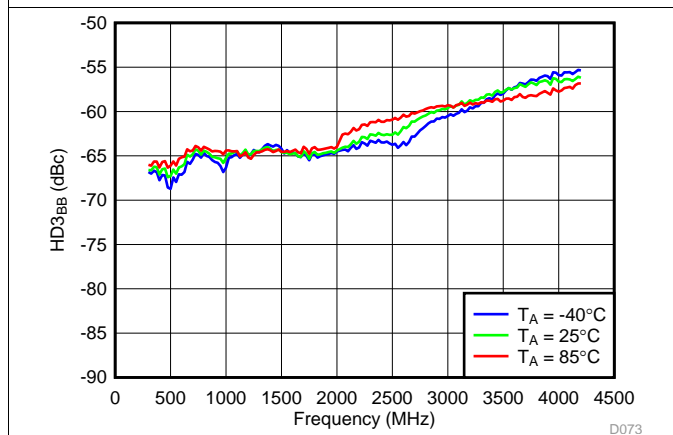

Figure 72. BB-HD3 vs Temperature, Low Power Mode

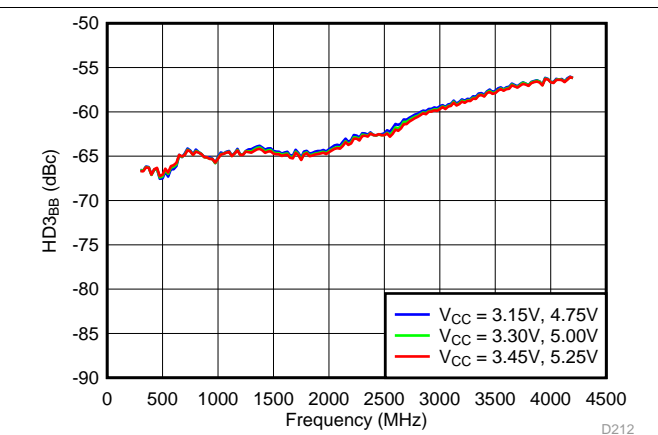

Figure 73. BB-HD3 vs Supply, Low Power Mode

7.17 Typical Characteristics - RF Output Return Loss

Unless specified all plots were created at RFOUT pin using TRF3722EVM, VCC = 3.3 V, VCC_TK= 5 V, and T_A = 25°C

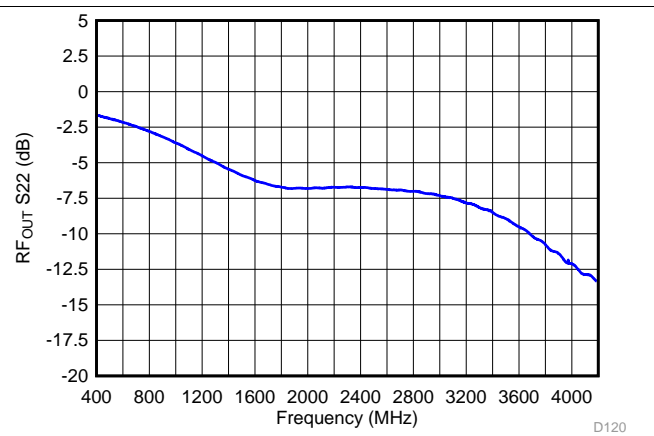
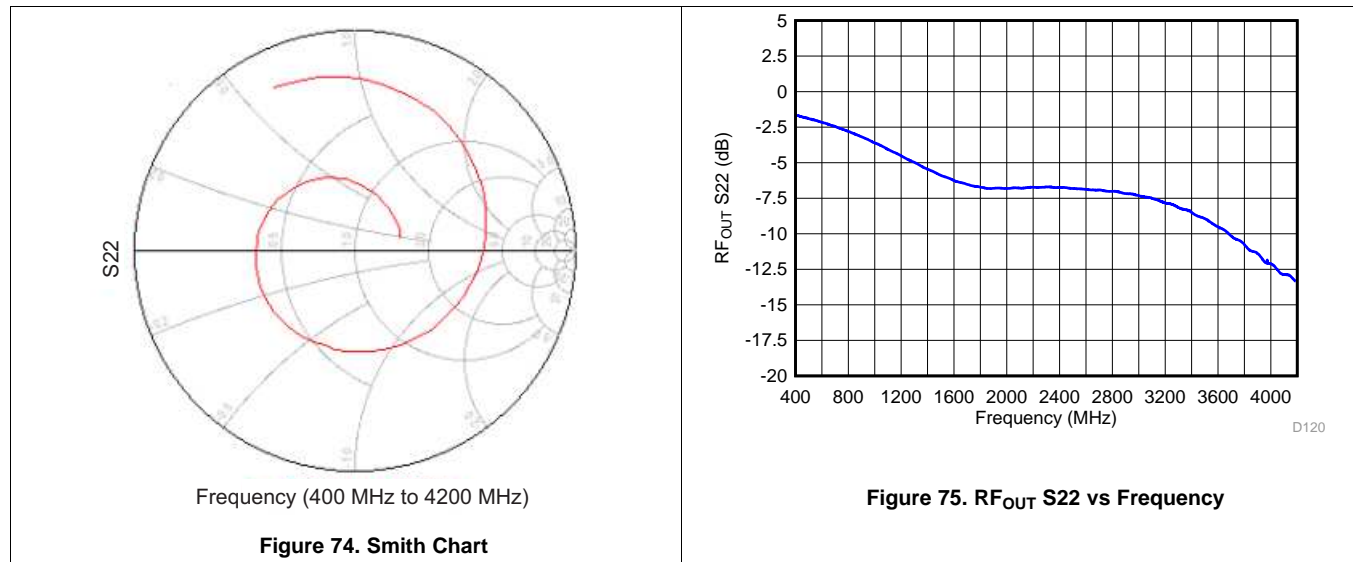
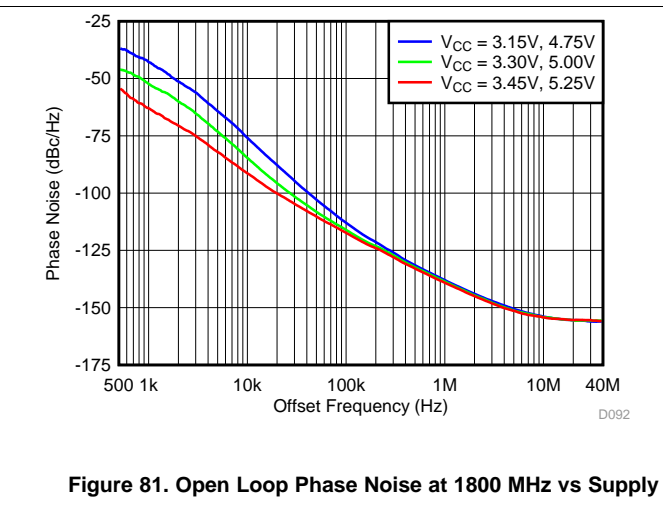
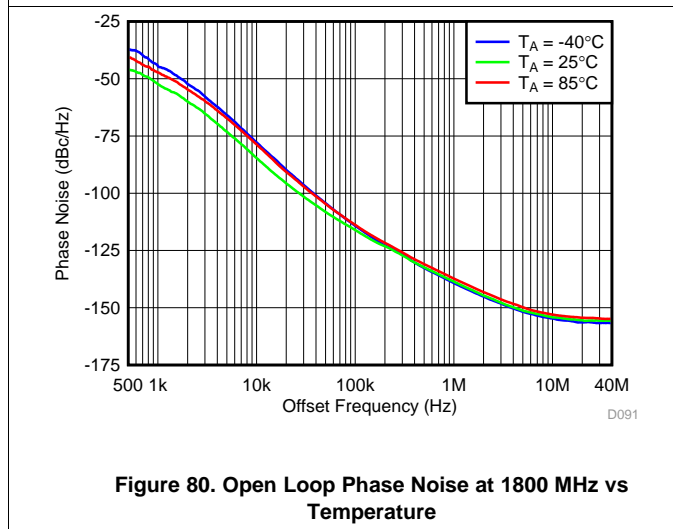
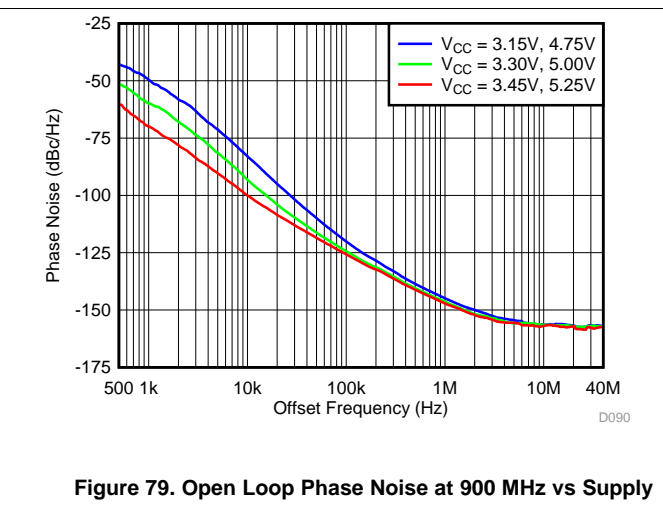
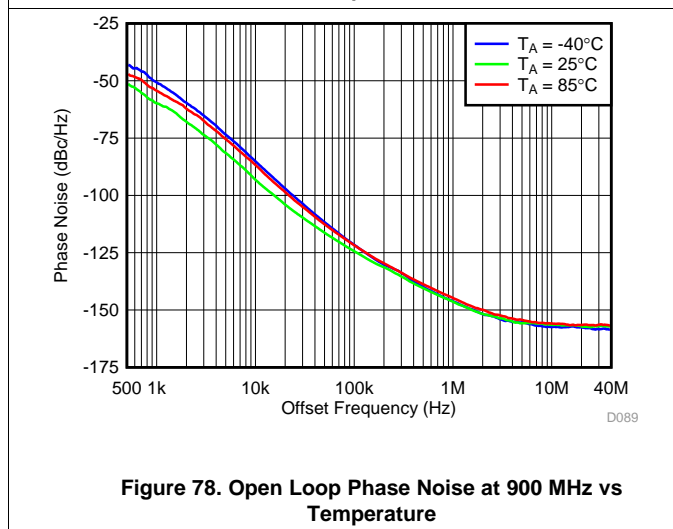
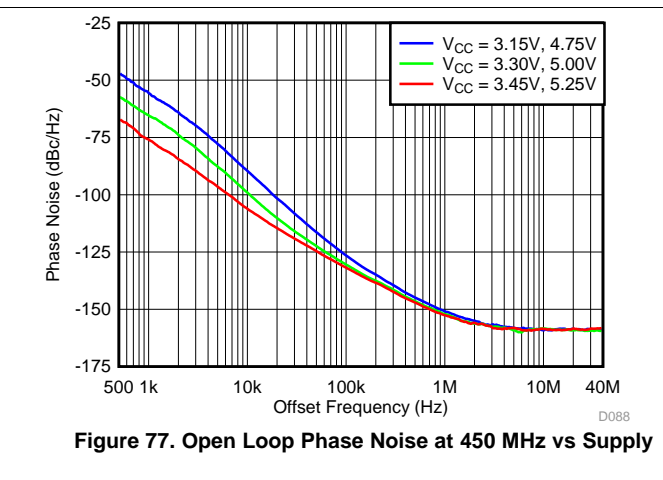
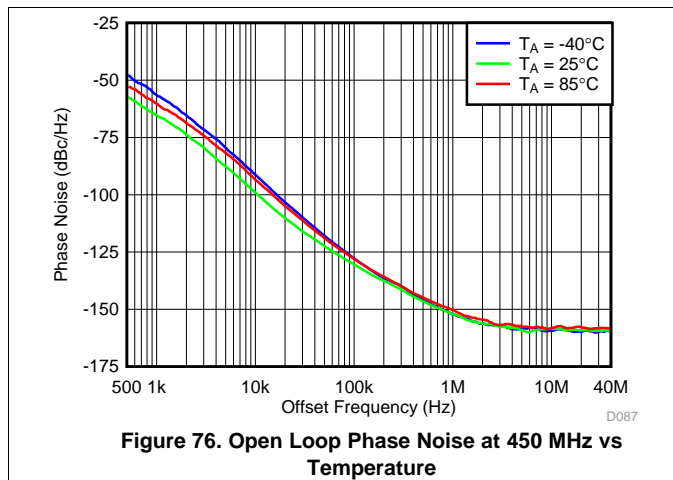

Figure 75. RF_{OUT} S₂₂ vs Frequency

7.18 Typical Characteristics - PLL/VCO

Unless specified all plots were created using TRF3722EVM, VCC = 3.3 V, VCC_TK = 5 V, and T_A = 25°C. Measured at LO_OUTP with 50 Ω bias resistor and 47 pF series capacitor. Modulator section powered down. Reference frequency is set to 61.44 MHz. Optimized bias settings as per Table 16.



Typical Characteristics - PLL/VCO (continued)

Unless specified all plots were created using TRF3722EVM, VCC = 3.3 V, VCC_TK = 5 V, and T_A = 25°C. Measured at LO_OUTP with 50 Ω bias resistor and 47 pF series capacitor. Modulator section powered down. Reference frequency is set to 61.44 MHz. Optimized bias settings as per Table 16.

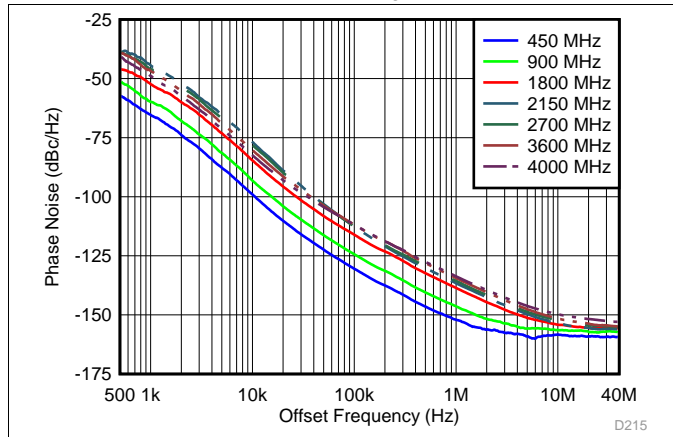

Figure 82. Open Loop Phase Noise vs Frequency

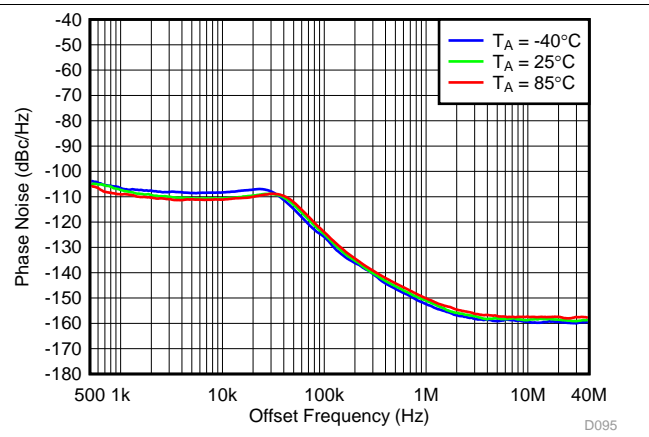

Figure 83. 450 MHz Frac-N (Closed Loop Phase Noise) vs Temperature

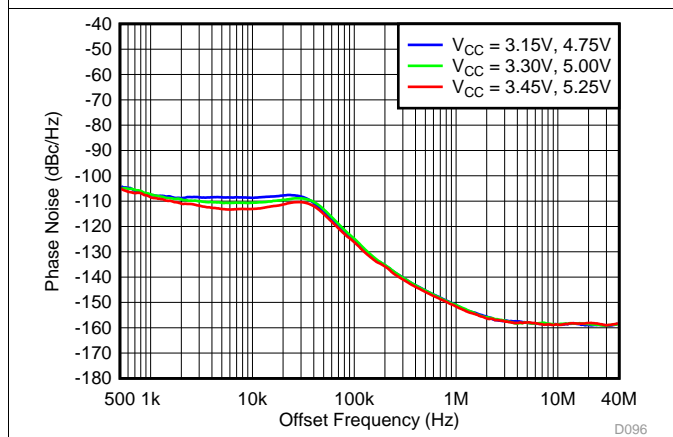

Figure 84. 450 MHz Frac-N (Closed Loop Phase Noise) vs Supply

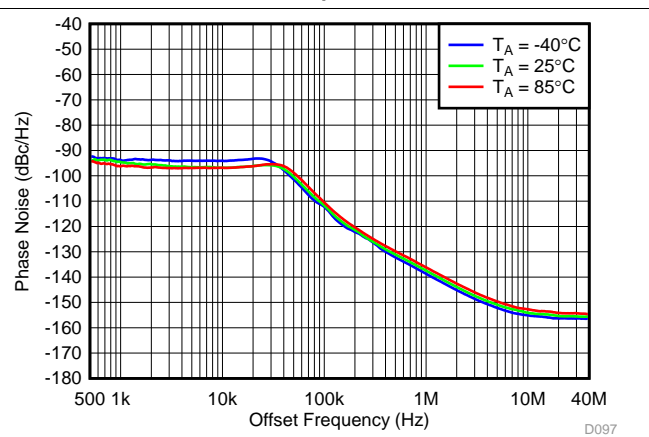

Figure 85. 1800 MHz Frac-N (Closed Loop Phase Noise) vs Temperature

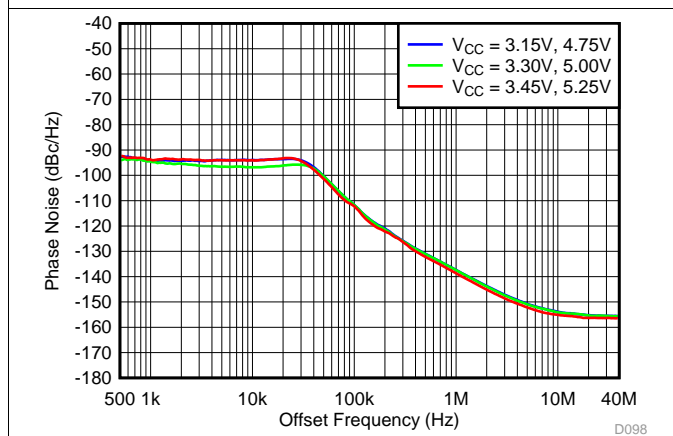

Figure 86. 1800 MHz Frac-N (Closed Loop Phase Noise) vs Supply

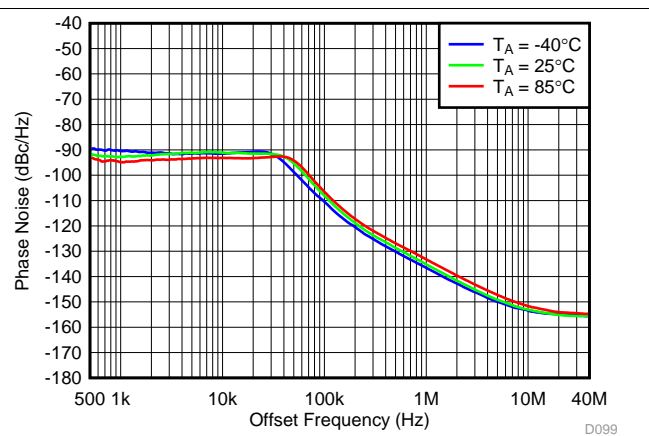

Figure 87. 2150 MHz Frac-N (Closed Loop Phase Noise) vs Temperature

Typical Characteristics - PLL/VCO (continued)

Unless specified all plots were created using TRF3722EVM, VCC = 3.3 V, VCC_TK = 5 V, and TA = 25°C. Measured at LO_OUTP with 50 Ω bias resistor and 47 pF series capacitor. Modulator section powered down. Reference frequency is set to 61.44 MHz. Optimized bias settings as per Table 16.

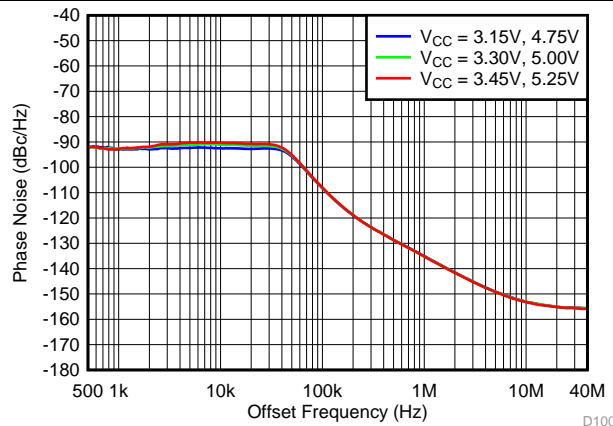

Figure 88. 2150 MHz Frac-N (Closed Loop Phase Noise) vs Supply

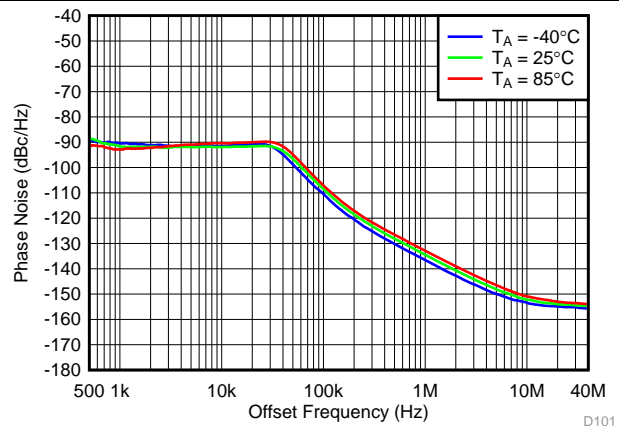

Figure 89. 2700 MHz Frac-N (Closed Loop Phase Noise) vs Temperature

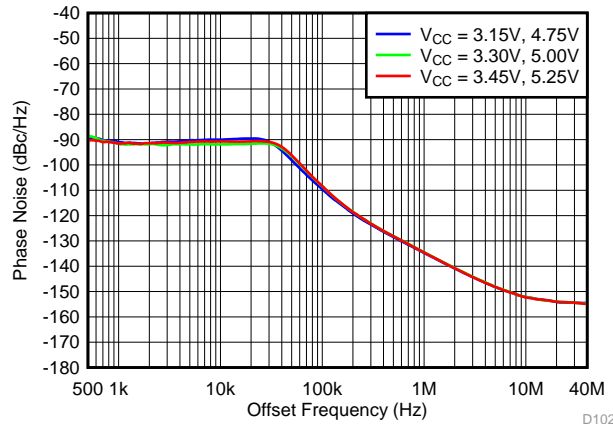

Figure 90. 2700 MHz Frac-N (Closed Loop Phase Noise) vs Supply

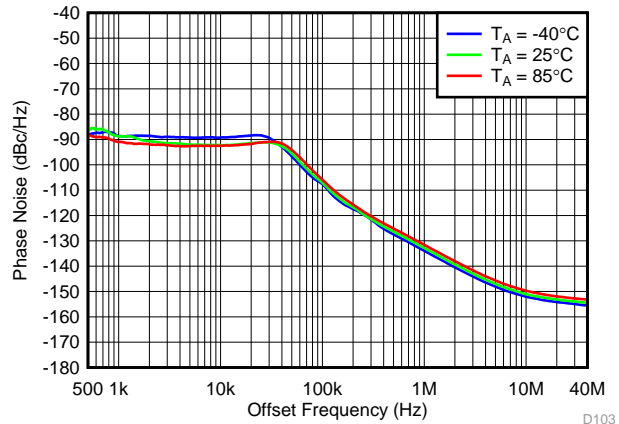

Figure 91. 3600 MHz Frac-N (Closed Loop Phase Noise) vs Temperature

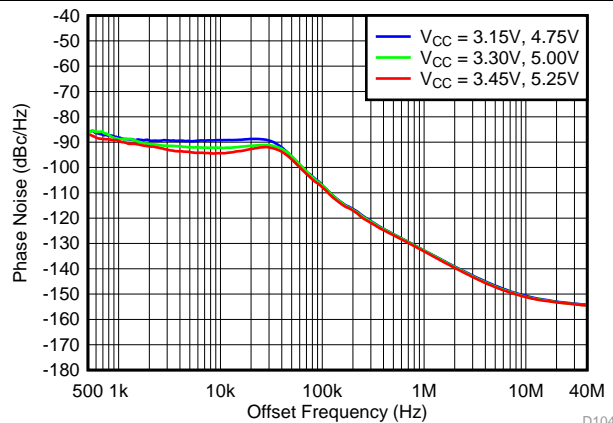

Figure 92. 3600 MHz Frac-N (Closed Loop Phase Noise) vs Supply

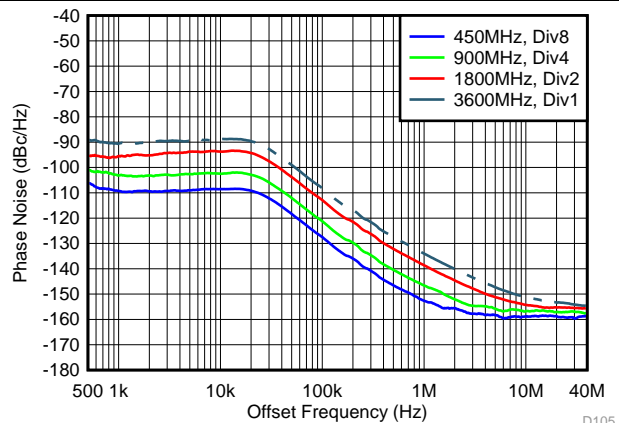

Figure 93. 450, 900, 1800, 3600 MHz Closed Loop Phase Noise vs Offset Frequency

Typical Characteristics - PLL/VCO (continued)

Unless specified all plots were created using TRF3722EVM, VCC = 3.3 V, VCC_TK = 5 V, and T_A = 25°C. Measured at LO_OUTP with 50 Ω bias resistor and 47 pF series capacitor. Modulator section powered down. Reference frequency is set to 61.44 MHz. Optimized bias settings as per Table 16.

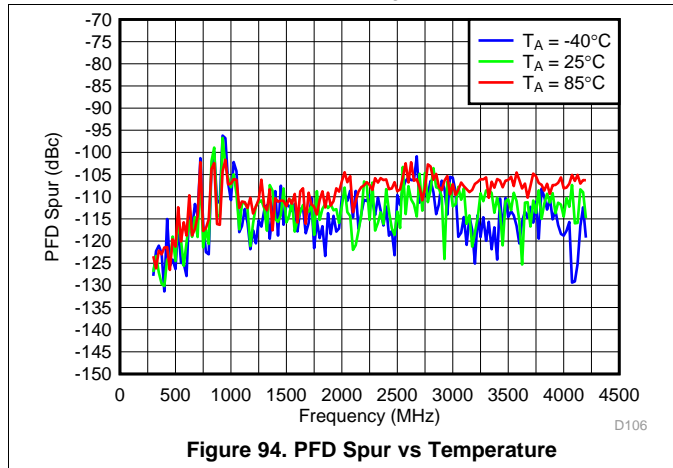

Figure 94. PFD Spur vs Temperature

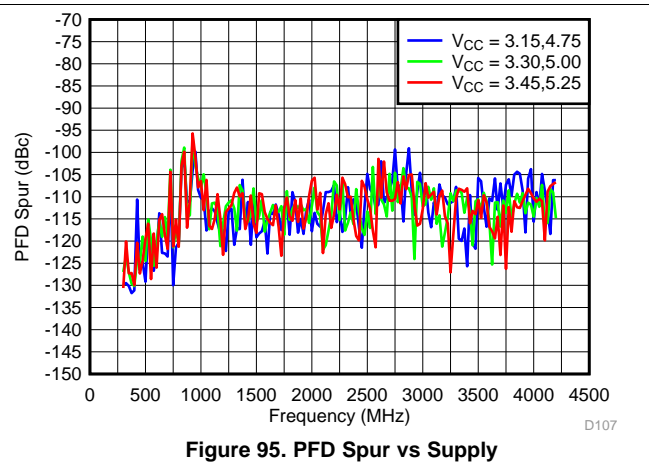

Figure 95. PFD Spur vs Supply

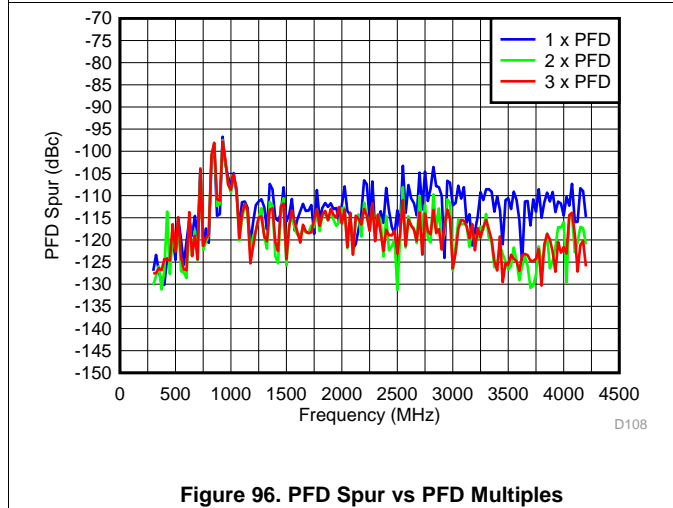

Figure 96. PFD Spur vs PFD Multiples

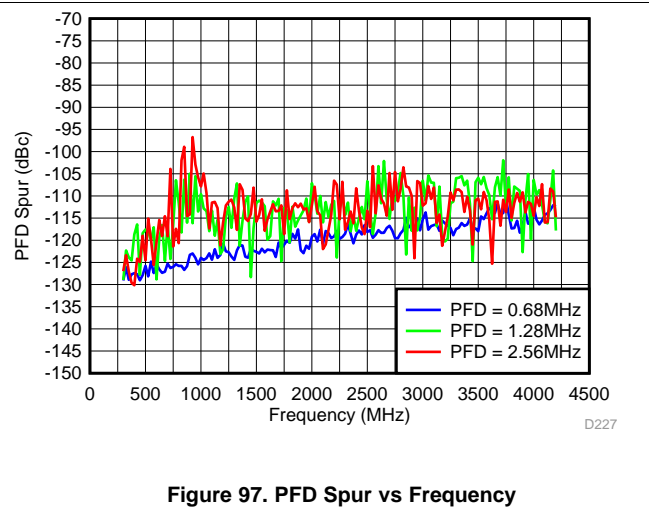

Figure 97. PFD Spur vs Frequency

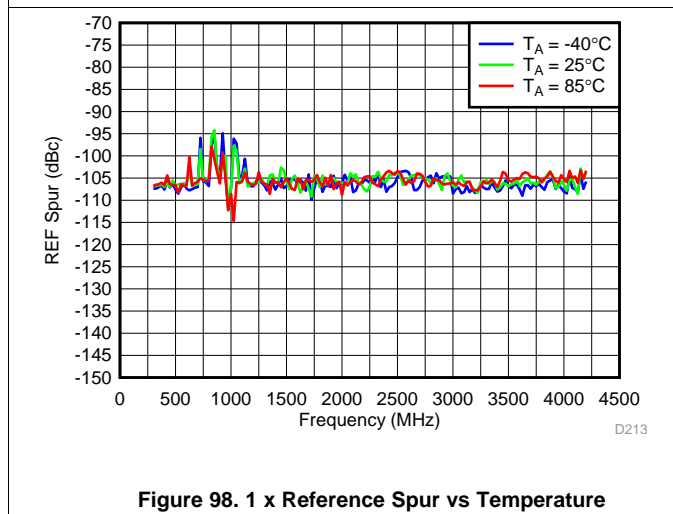

Figure 98. 1 x Reference Spur vs Temperature

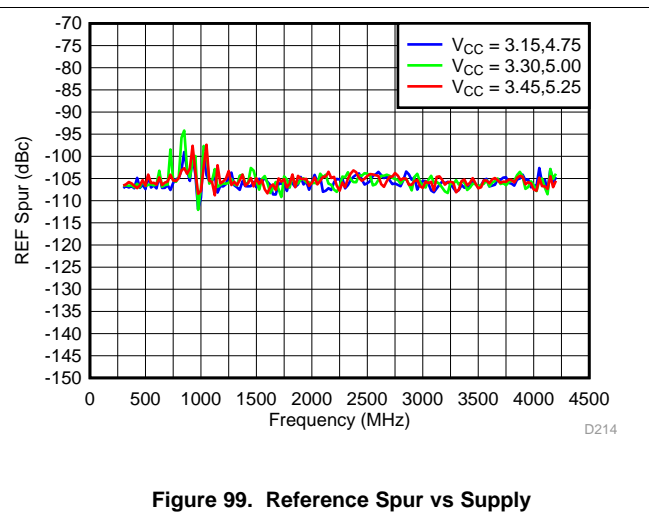

Figure 99. Reference Spur vs Supply

Typical Characteristics - PLL/VCO (continued)

Unless specified all plots were created using TRF3722EVM, VCC = 3.3 V, VCC_TK = 5 V, and TA = 25°C. Measured at LO_OUTP with 50 Ω bias resistor and 47 pF series capacitor. Modulator section powered down. Reference frequency is set to 61.44 MHz. Optimized bias settings as per Table 16.

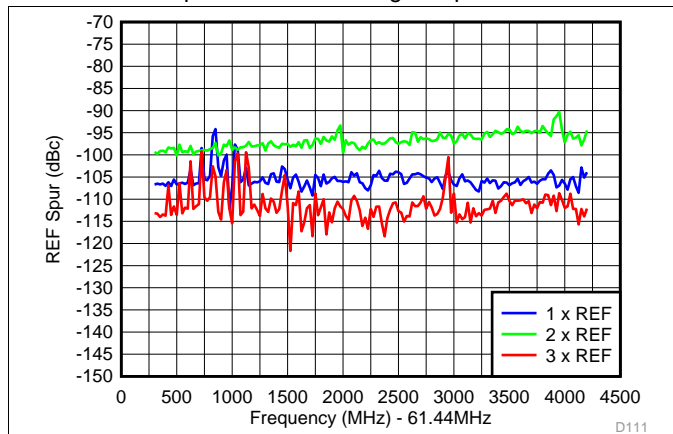

Figure 100. Reference Spur vs Reference Multiples

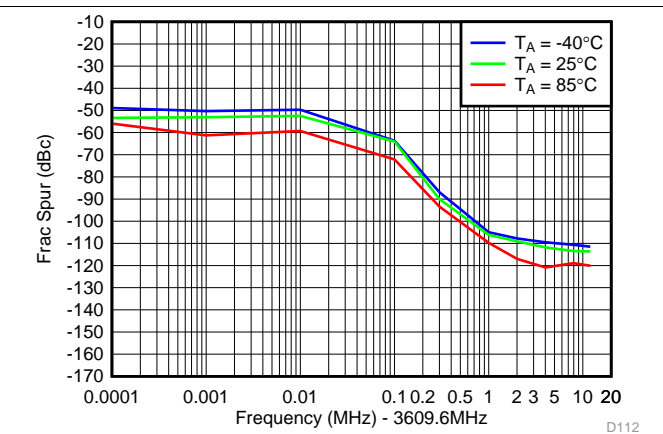

Figure 101. 3609.6 MHz Integer Boundary Spur vs Temperature

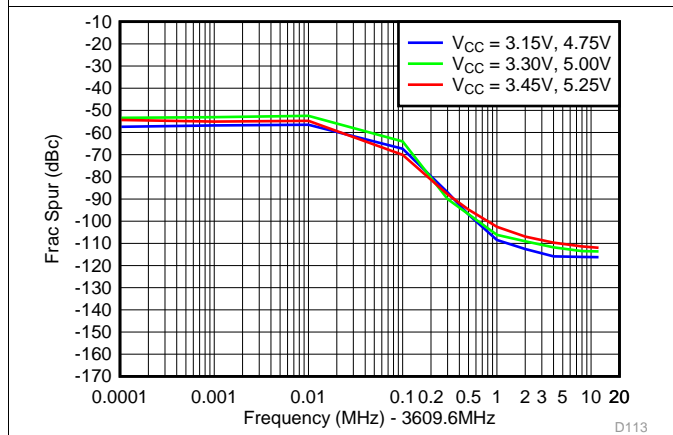

Figure 102. 3609.6 MHz Integer Boundary Spur vs Supply

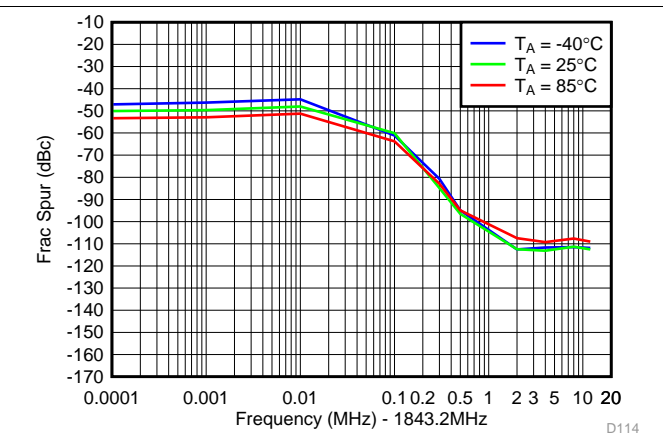

Figure 103. 1843.2 MHz Integer Boundary Spur vs Temperature

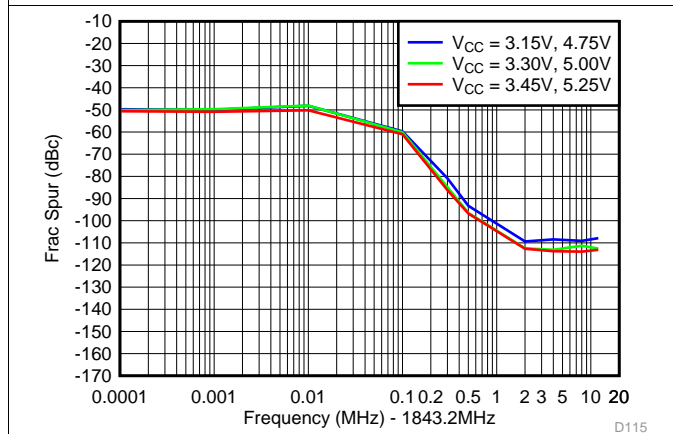

Figure 104. 1842.2 MHz Integer Boundary Spur vs Supply

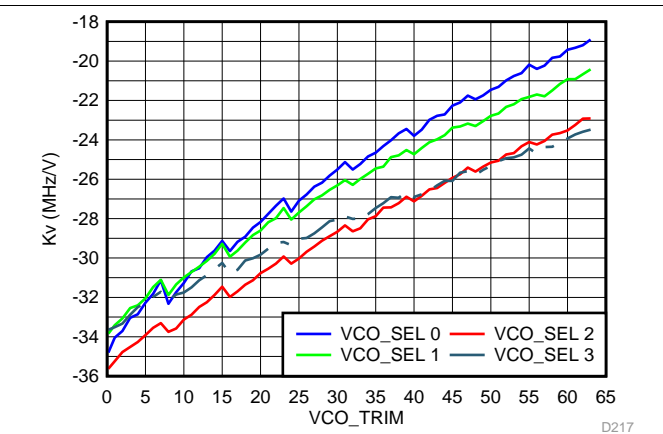

Figure 105. KVCO vs VCO Trim

Typical Characteristics - PLL/VCO (continued)

Unless specified all plots were created using TRF3722EVM, $V_{CC} = 3.3\text{ V}$, $V_{CC_TK} = 5\text{ V}$, and $T_A = 25^\circ\text{C}$. Measured at LO_OUTP with $50\ \Omega$ bias resistor and 47 pF series capacitor. Modulator section powered down. Reference frequency is set to 61.44 MHz . Optimized bias settings as per [Table 16](#).

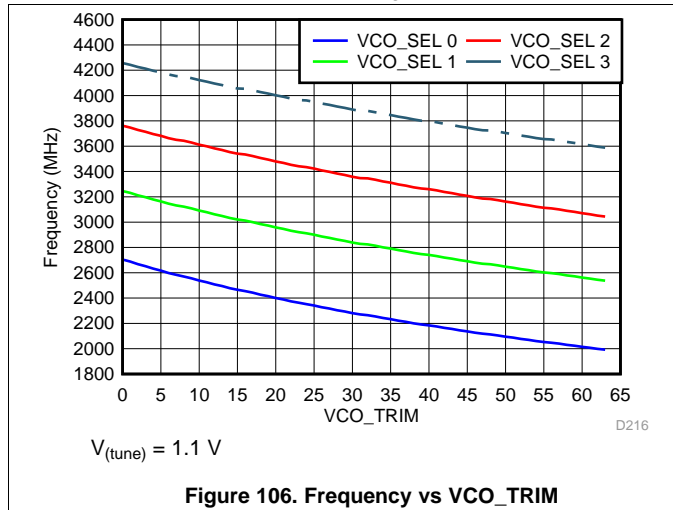

Figure 106. Frequency vs VCO_TRIM

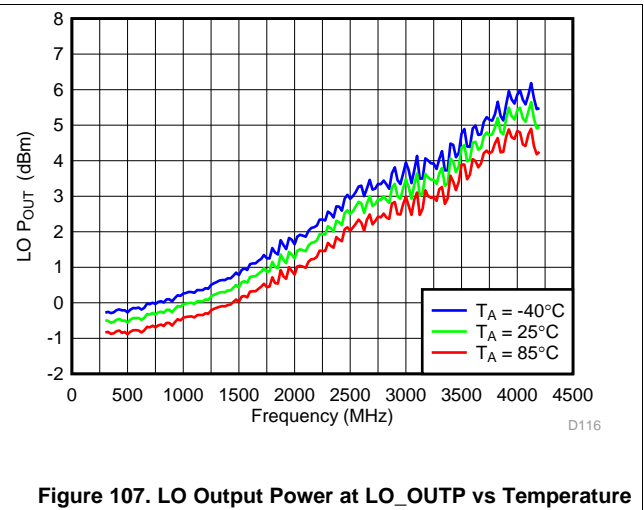

Figure 107. LO Output Power at LO_OUTP vs Temperature

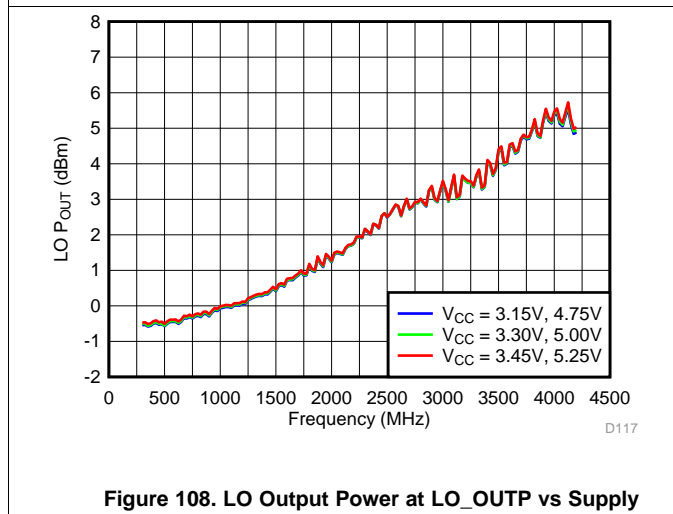

Figure 108. LO Output Power at LO_OUTP vs Supply

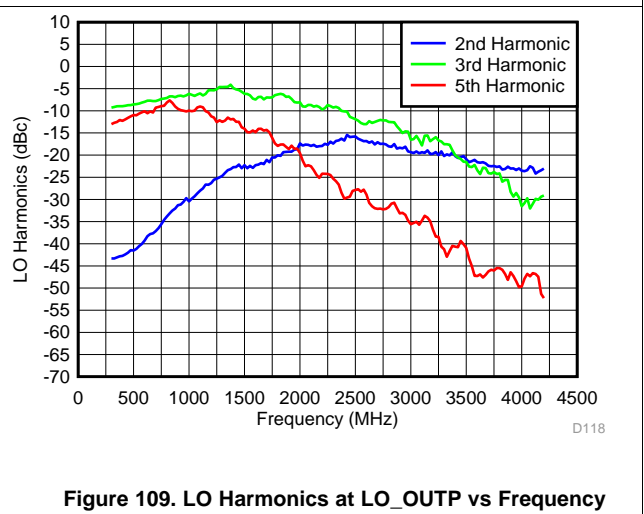

Figure 109. LO Harmonics at LO_OUTP vs Frequency

7.19 Typical Characteristics - Current Consumption

Unless specified all plots were created using TRF3722EVM, VCC = 3.3 V, VCC_TK= 5 V, and T_A = 25°C, . Optimized bias settings as per Table 16

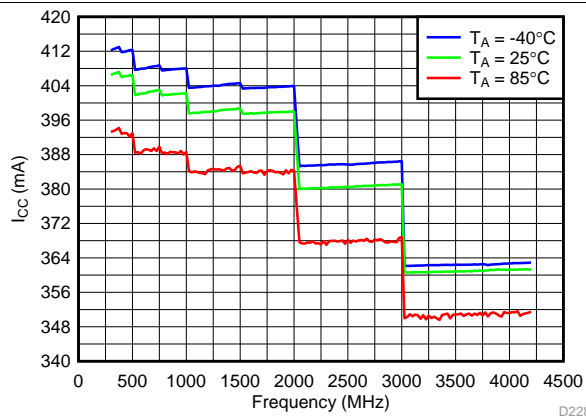

Figure 110. 3.3V Supply Current vs Temperature, Typical Operating Mode

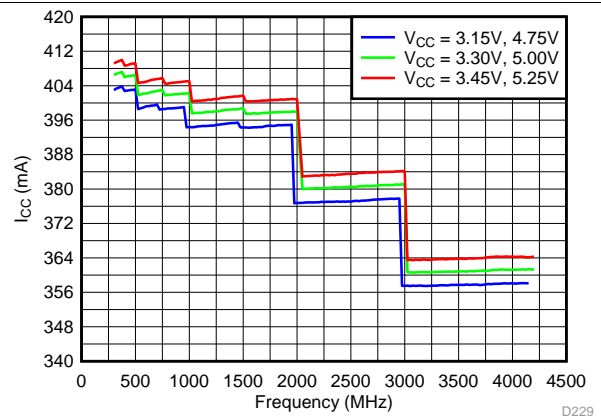

Figure 111. 3.3V Supply Current vs Supply, Typical Operating Mode

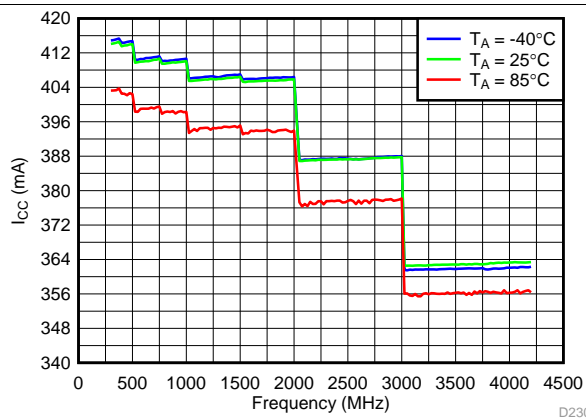

Figure 112. 3.3V Supply Current vs Temperature, High Gain Mode

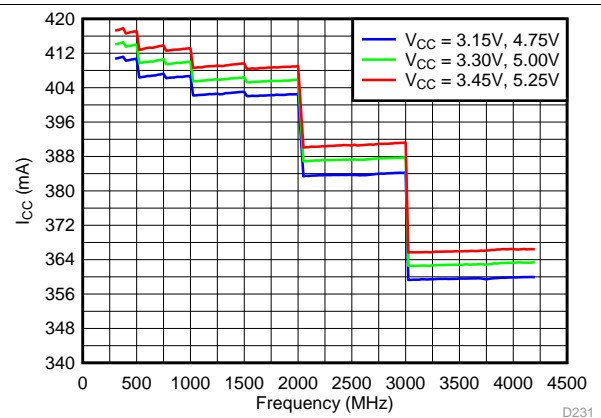

Figure 113. 3.3V Supply Current vs Supply, High Gain Mode

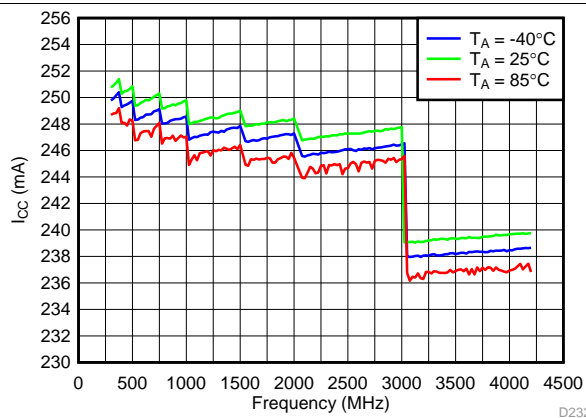

Figure 114. 3.3V Supply Current vs Temperature, Low Power Mode

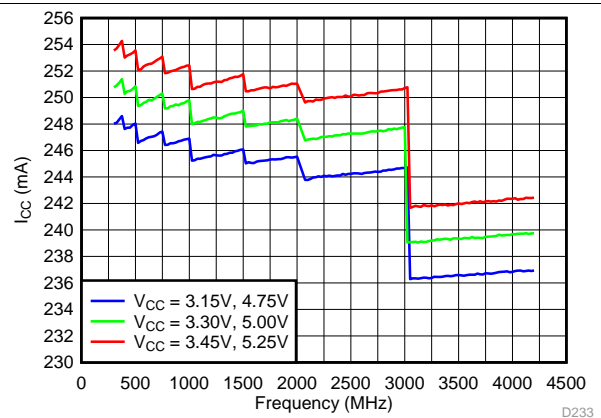

Figure 115. 5V Supply Current vs Supply, Low Power Mode

Typical Characteristics - Current Consumption (continued)

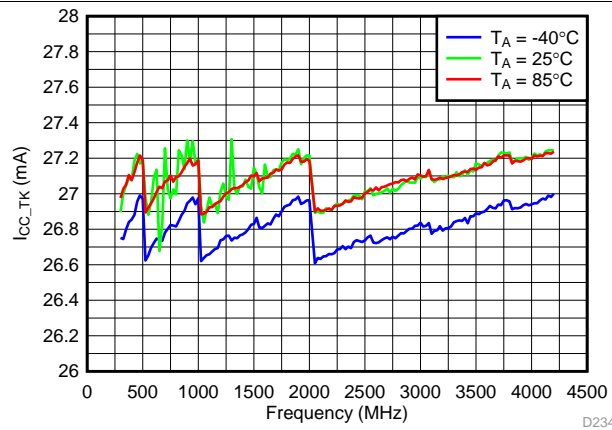

Figure 116. 5V Supply Current vs Temperature, Typical Operating Mode

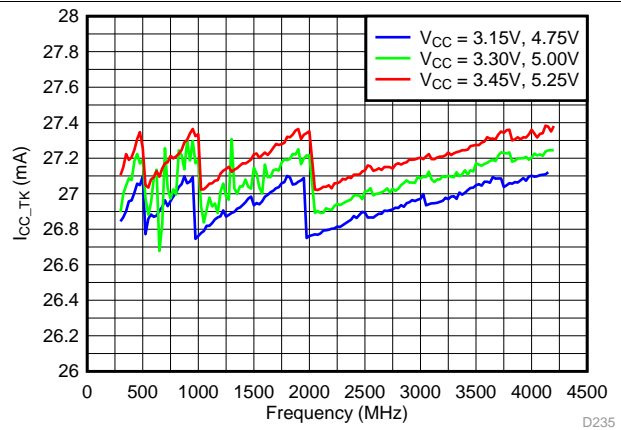

Figure 117. 5V Supply Current vs Temperature, Typical Operating Mode

7.20 Typical Characteristics - Power Dissipation

Unless specified all plots were created using TRF3722EVM, VCC = 3.3 V, VCC_TK= 5 V, and T_A = 25°C, . Optimized bias settings as per Table 16.

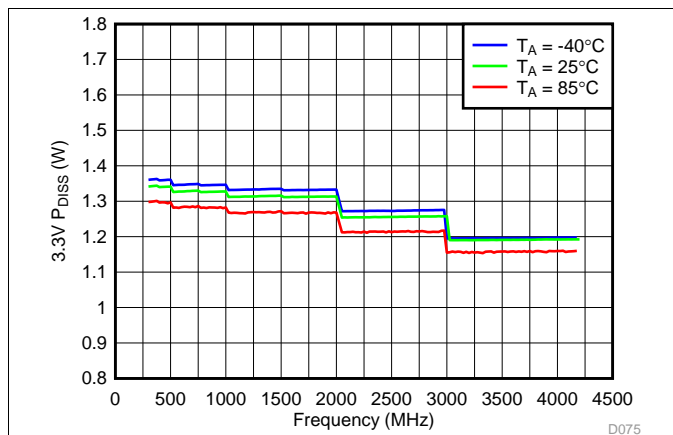

Figure 118. 3.3 V P_{DISS} vs Temperature, Typical Operating Mode

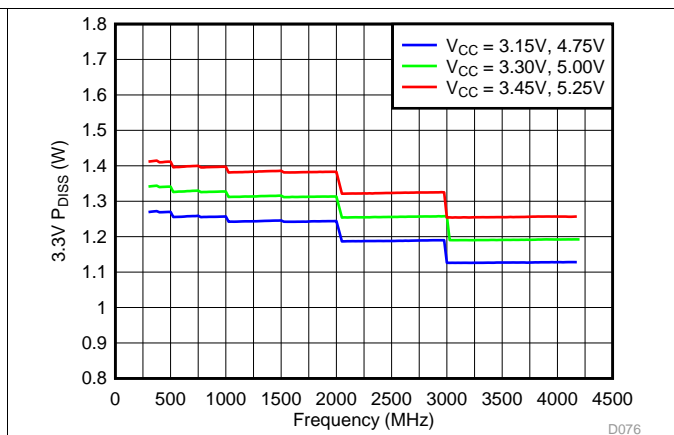

Figure 119. 3.3 V P_{DISS} vs Supply, Typical Operating Mode

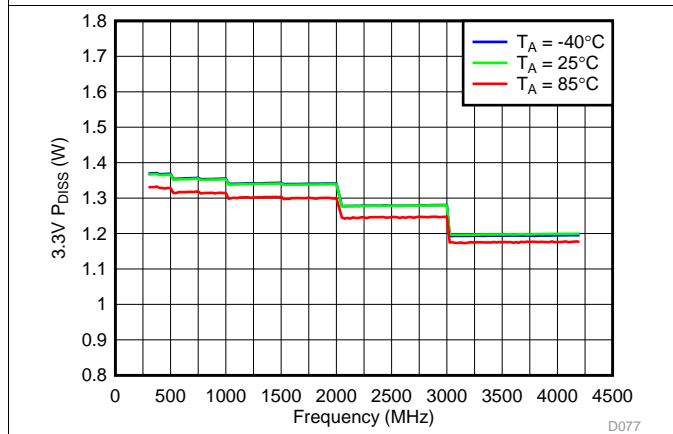

Figure 120. 3.3 V P_{DISS} vs Temperature, High Gain Mode

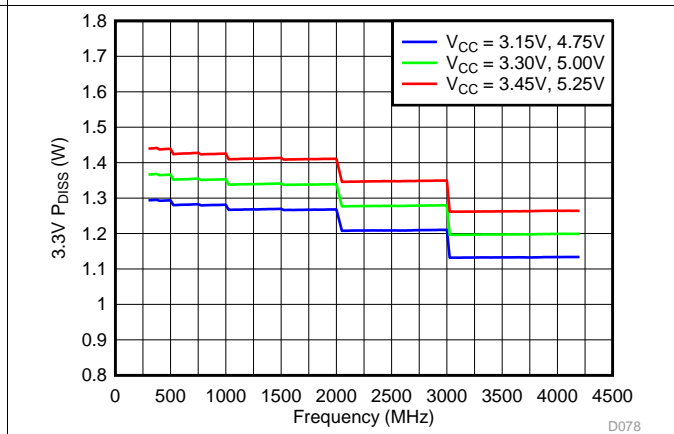

Figure 121. 3.3 V P_{DISS} vs Supply, High Gain Mode

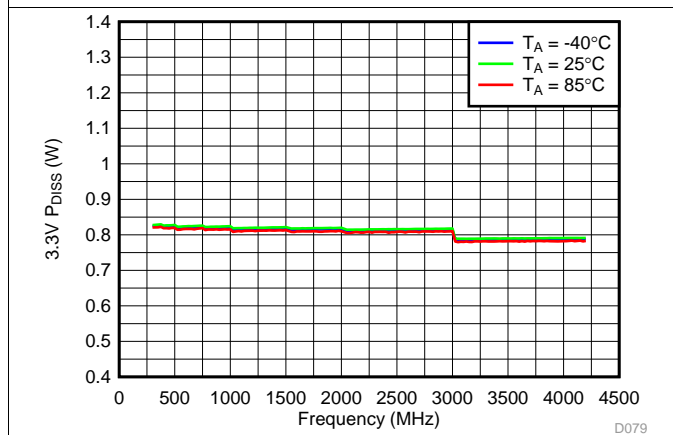

Figure 122. 3.3 V P_{DISS} vs Temperature, Low Power Mode

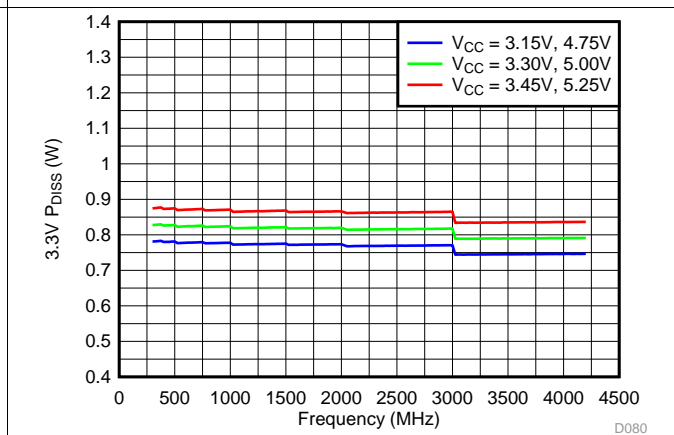
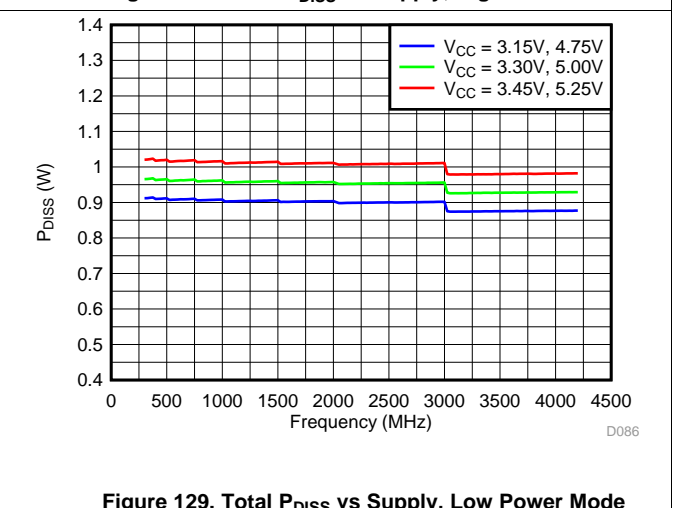
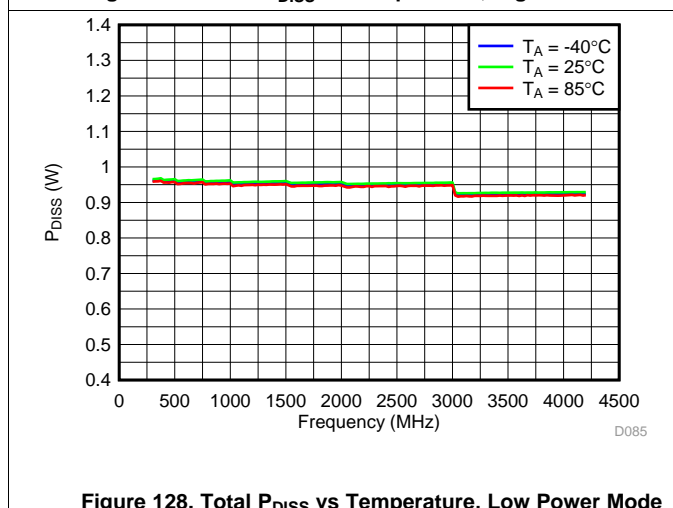
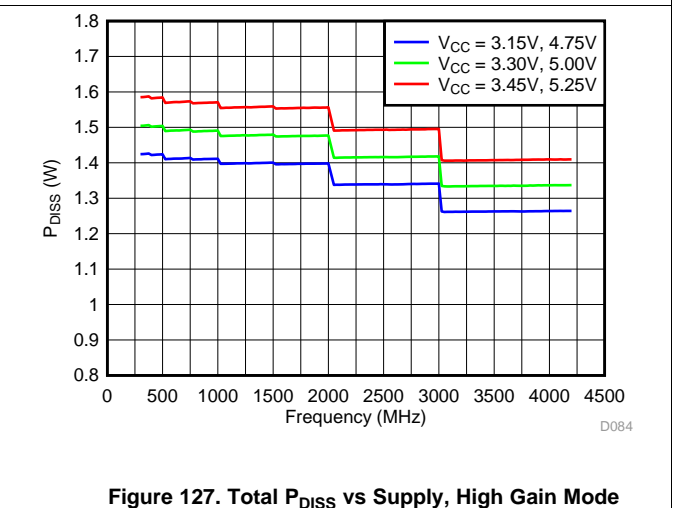
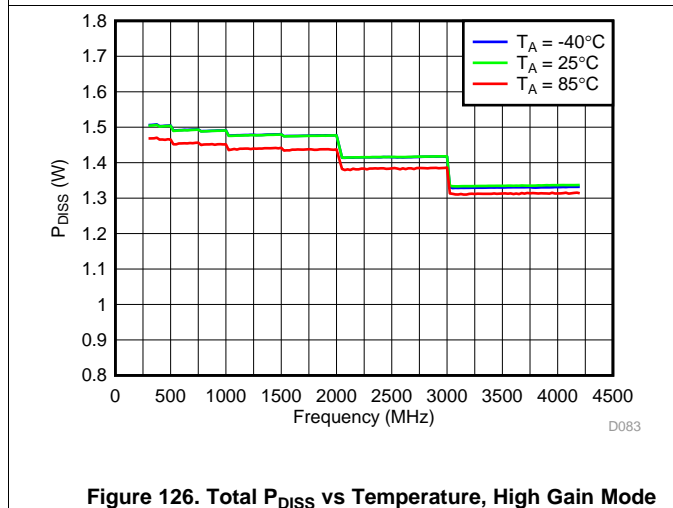
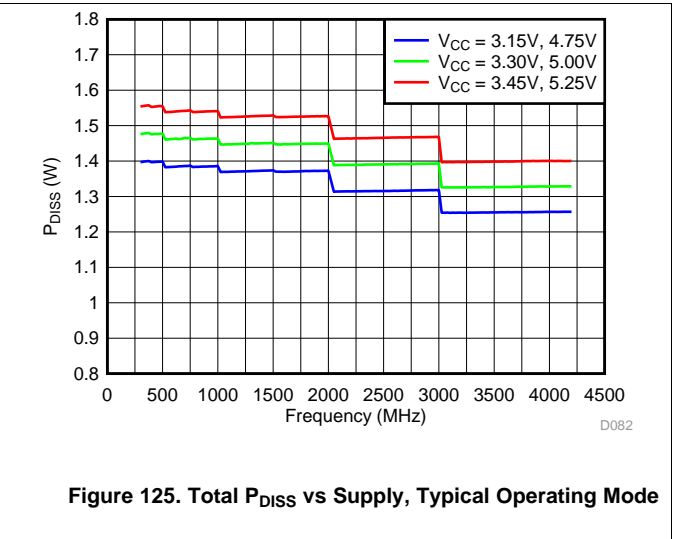
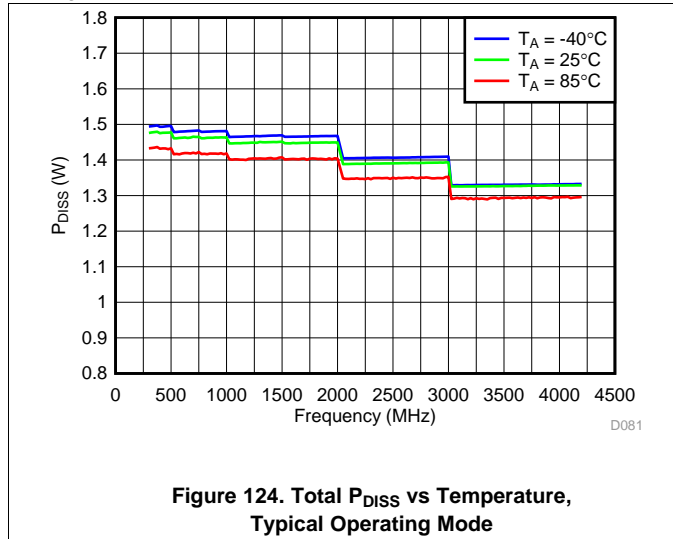

Figure 123. 3.3 V P_{DISS} vs Supply, Low Power Mode

Typical Characteristics - Power Dissipation (continued)

Unless specified all plots were created using TRF3722EVM, VCC = 3.3 V, VCC_TK= 5 V, and T_A = 25°C, . Optimized bias settings as per Table 16.



8 Parameter Measurement Information

8.1 Serial Interface Timing Diagram

The TRF3722 features a four-wire serial programming interface (4WI) that controls an internal 32-bit shift register with seven parallel registers. There are total of three signals that must be applied: the clock (CLK), the serial data (DATA), and the latch enable (LE). The fourth signal is the read back (RDBK) signal. The serial data (DB0-DB31) are loaded least significant bit (LSB) first, and read on the rising edge of the CLK. LE is asynchronous to the CLK signal; at its rising edge, the data in the shift register are loaded into the selected internal register. Figure 130 shows the timing diagram the 4WI. Table 1 lists the 4WI timing for the write operation.

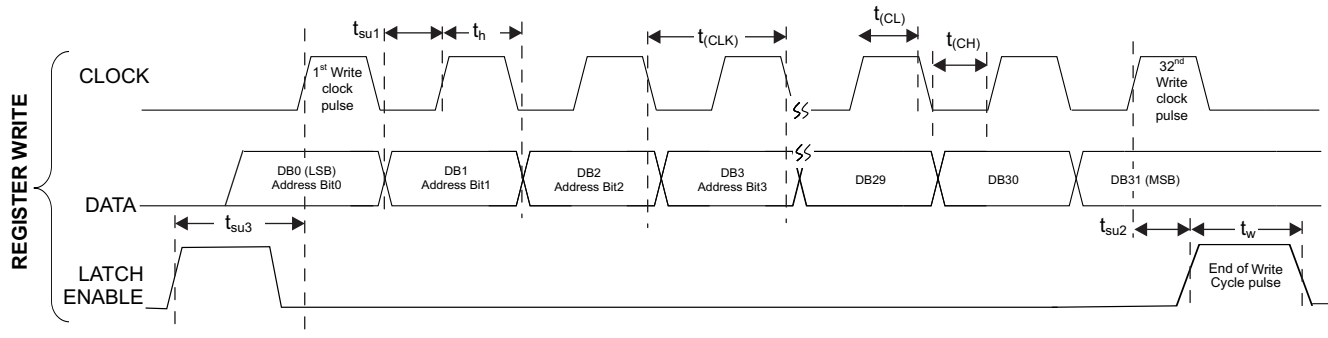

Figure 130. 4WI Writing Timing Diagram

Table 1. 4WI Timing for Write Operation

Parameter	Symbol	Min	Typ	Max	Units
Hold time, data to clock	t_h	20			ns
Setup time, data to clock	t_{su1}	20			ns
Clock low duration	t_{cl}	20			ns
Clock High duration	t_{ch}	20			ns
Setup time, clock to enable	t_{su2}	20			ns
Clock period	t_{clk}	50			ns
Enable Time	t_w	50			ns
Setup time, Latch to Data	t_{su3}	70			ns

TRF3722 integrates 7 registers: Register 0 (000) to Register 6 (110). Registers 1 through 6 are used to set-up and control the TRF3722 functionalities, while register 0 is used for the read-back function. Each read-back is composed by two phases: writing followed by the actual reading of the internal data. This is shown in the timing diagram in [Figure 131](#).

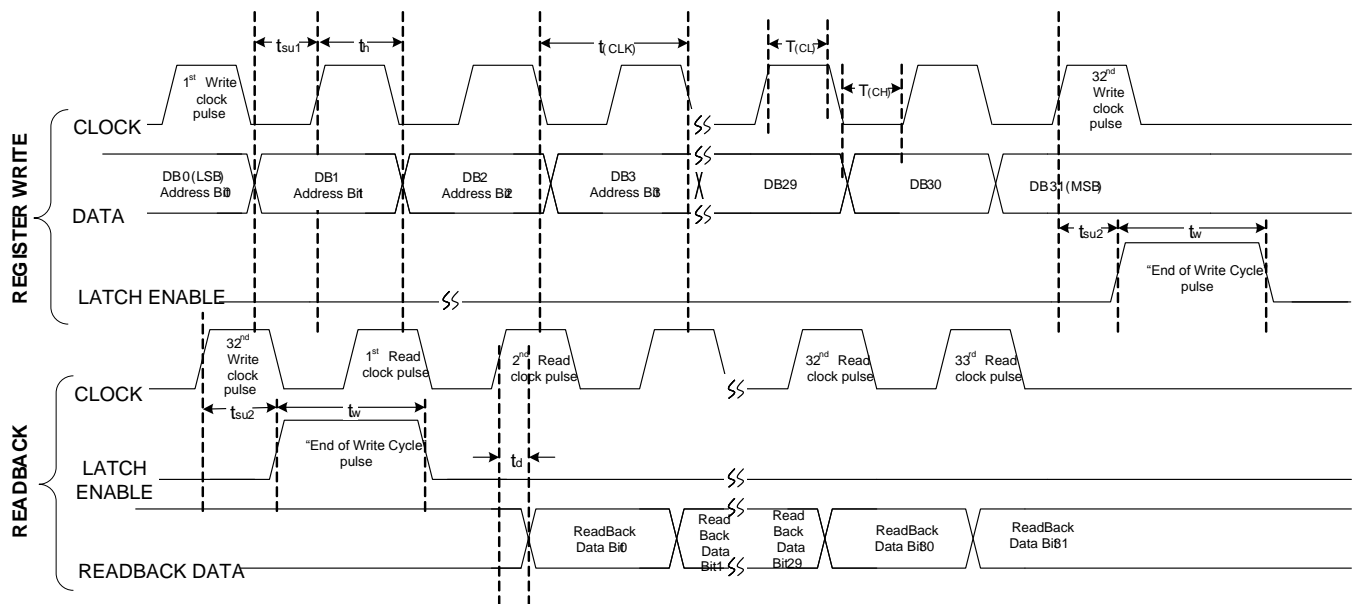

Figure 131. 4WI Read-Back Timing Diagram

During the writing phase a command is sent to TRF3722 register 0 to set it in read-back mode and to specify which register is to be read. In the proper reading phase, at each rising clock edge, the internal data is transferred into the RDBK pin and can be read at the following falling edge (LSB first). The first clock after the LE goes high (end of writing cycle) is idle and the following 32 clocks pulses will transfer the internal register content to the RDBK pin. [Table 2](#) shows the Readback timing.

Table 2. 4WI Timing for Readback Timing

Parameter	Symbol	Min	Typ	Max	Units	Comments
Hold time, data to clock	t_h	20			ns	
Setup time, data to clock	t_{SU1}	20			ns	
Clock low duration	t_{CH}	20			ns	
Clock High duration	t_{CL}	20			ns	
Setup time, clock to enable	t_{SU2}	20			ns	
Setup time, enable to Readback clock	t_{SU3}	20			ns	
Delay time, clock to Readback data output	t_d	10				
Enable Time	t_w	50			ns	Equals Clock period
Clock period	$t_{(CLK)}$	50			ns	

9 Detailed Description

9.1 Overview

TRF3722 integrates a high performance direct conversion quadrature modulator with exceptional linearity and low noise performance. The modulator which upconverts low frequency baseband signal to high frequency RF typically operates at 0.25 V common mode. It supports seamless interface with current source DACs. It also features high gain and low power operating modes. Additionally, TRF3722 integrates PLL and VCO to provide the local oscillator (LO) to the integrated modulator. The PLL and VCO provides excellent phase noise and extremely low spurious performance. The device also provides an LO output for driving another modulator or mixer. TRF3722 supports the use of an external VCO or LO signal.

9.2 Functional Block Diagram

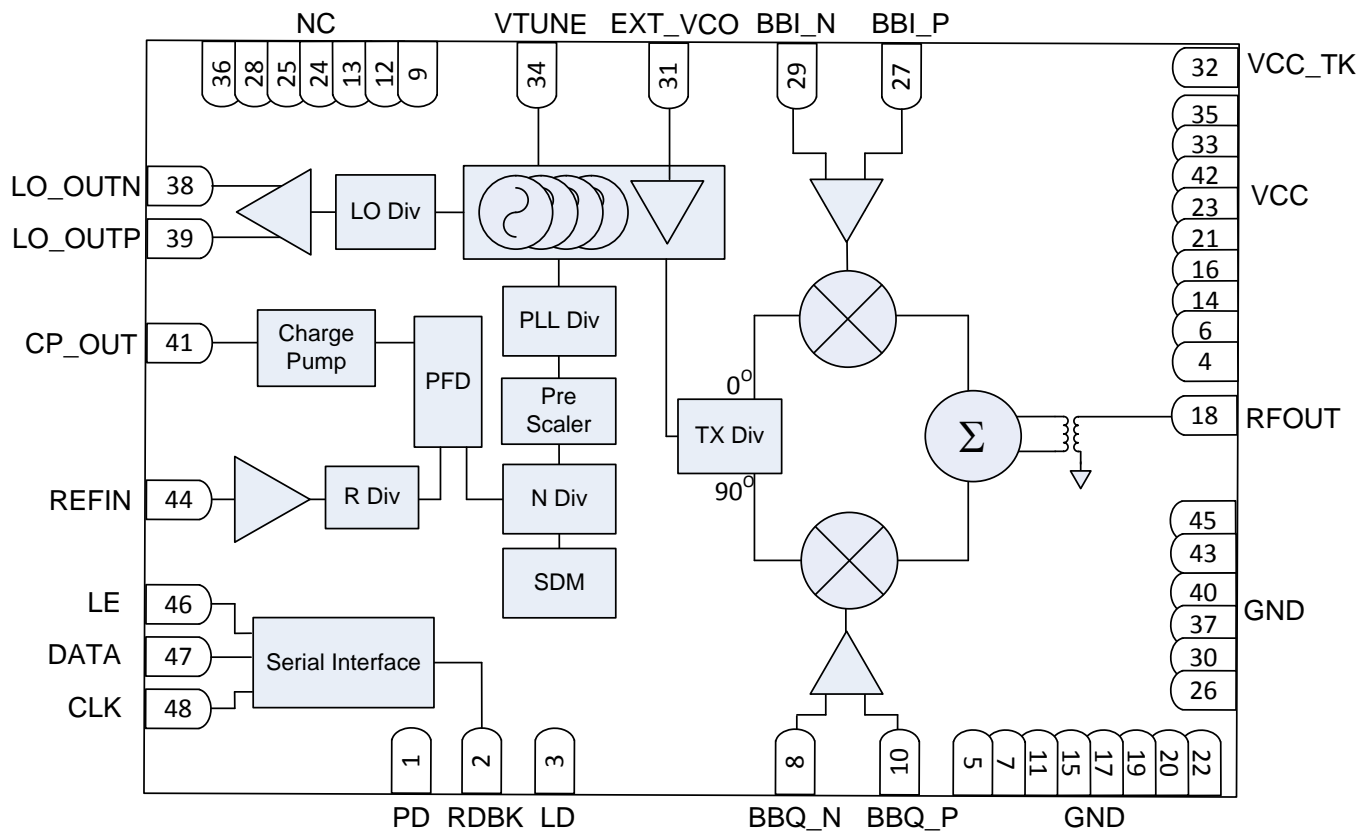

9.3 Feature Description

9.3.1 RF Output

The RF output is single ended and can drive a 50-Ω load. It can be tuned with the use of an output matching network to optimize the linearity and return loss performance within a selected band.

9.3.2 Baseband Inputs

The baseband inputs consist of the in-phase signal (I) and the quadrature-phase signals (Q). These I and Q signals are differential. The baseband lines are nominally biased at 0.25-V common-mode voltage (V_{CM}); however, the device can operate with a V_{CM} in the range of 0 V to 0.5 V. The baseband input lines are normally terminated externally 50 Ω on TRF3722 evaluation board, though it is possible to modify this value if necessary to match to an external filter load impedance requirement.

9.3.3 LO Output

The LO outputs are open collector differential outputs and are biased externally. These differential outputs can be tuned to optimized output power along with OUTBUF_BIAS register settings. It also is possible to use LO outputs in single ended mode.

9.3.4 PLL Architecture

Figure 132 shows a block diagram of the PLL architecture.

The VCO output frequency (f_{VCO}) is given by Equation 1:

$$f_{VCO} = \frac{f_{REF}}{RDIV} \times PLL\ DIV \times \left(NINT + \frac{NFRAC}{2^{25}} \right) \quad (1)$$

$$f_{PFD} = \frac{f_{REF}}{RDIV} \quad (2)$$

$$PLL\ DIV = 2^{PLL_DIV_SEL} \quad (3)$$

$$f_{VCO} = f_{PFD} \times PLL\ DIV \times \left(NINT + \frac{NFRAC}{2^{25}} \right) \quad (4)$$

Where f_{REF} is the reference input frequency, RDIV is the reference divider division ratio and the phase - frequency detector frequency is f_{PFD} . PLL_DIV_SEL controls the division ratio of the programmable divider (PLL DIV) before the dual-modulus prescaler (DMP). NINT and NFRAC/ 2^{25} is the integer and fractional part of the fractional divider (N.f), respectively. In Integer mode, the fractional setting is ignored and Equation 5 is applied.

$$f_{VCO} = f_{PFD} \times PLL\ DIV \times NINT \quad (5)$$

The complete feedback divider block consists of a PLL DIV, DMP, and N.f. The prescaler can be programmed as either a 4/5 or an 8/9. N.f includes an A and M digital counters.

Feature Description (continued)

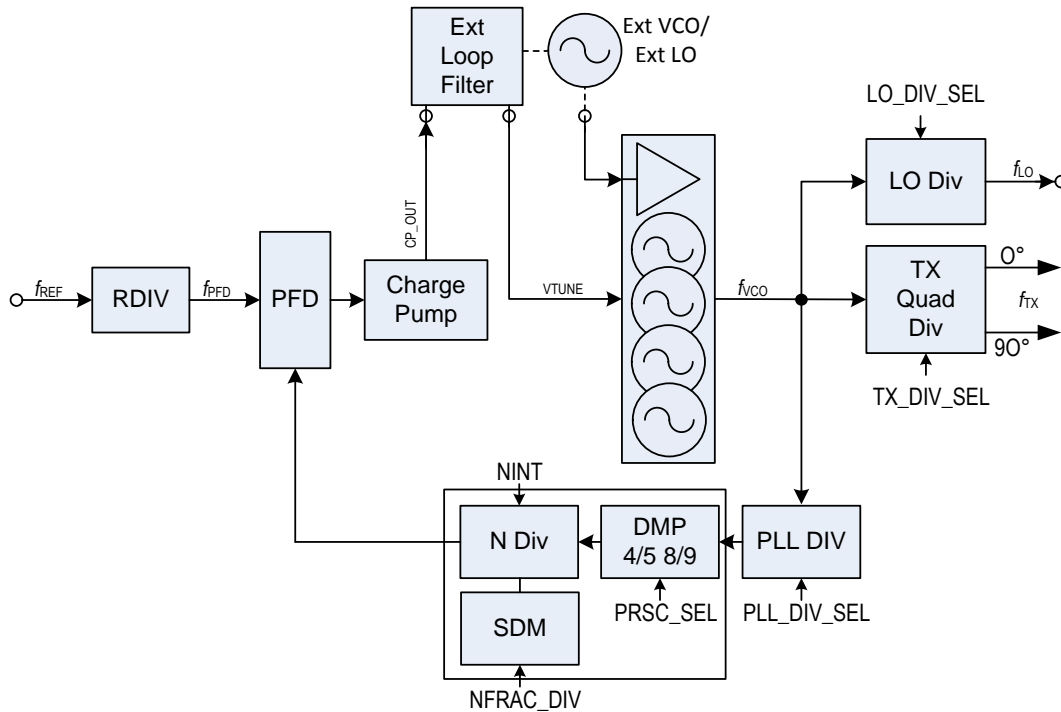

Figure 132. PLL Architecture

9.3.5 External VCO

An external LO or VCO signal may be applied. If an external LO is used the internal PLL can be powered down. Alternatively, dividers, phase-frequency detector, and charge pump can remain enabled and may be used to control the V_{TUNE} of an external VCO. EN_EXTVCO is used to select the internal or external VCO.

9.3.6 Loop Filter

Loop filter design is critical for achieving low closed loop phase noise. Complete modulator performance data has been measured using integer mode loop filter. The integer mode loop filter was designed considering loop bandwidth 40 kHz and f_{PFD} 2.56 MHz. Phase margin of 60 degrees was considered. Refer to TRF3722EVM User's Guide to obtain the details on TRF3722 loop component calculations. Figure 133, shows integer loop filter.

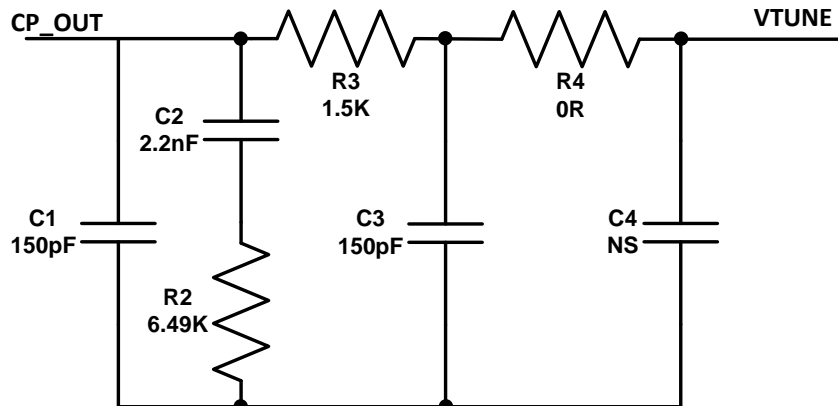

Figure 133. Integer Loop Filter

Feature Description (continued)

Frac-N performance data is obtained using the fractional loop filter shown in Figure 134. 40 kHz loop bandwidth and 15.36 MHz PFD was considered.

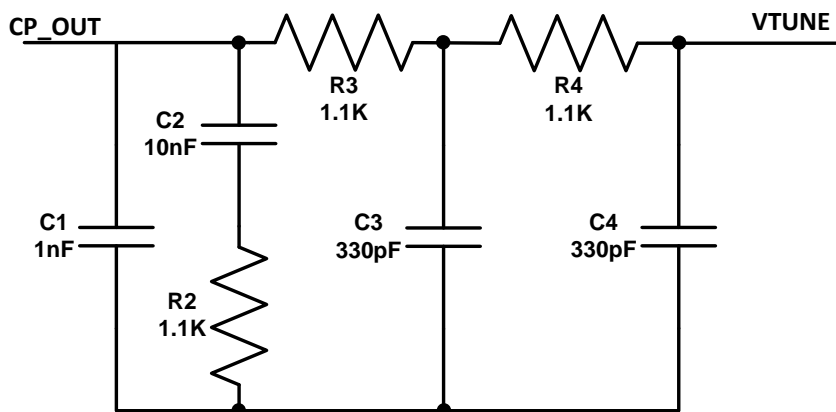

Figure 134. Fractional Loop Filter

9.3.7 Lock Detect

The lock detect signal is generated in the phase frequency detector by comparing the two input signals. When the two compared phase signals remain aligned for several clock cycles, an internal signal goes high. The precision of this comparison is controlled through the LD_ANA_PREC bits. This internal signal is then averaged and compared against a reference voltage to generate the lock detect (LD) signal. The number of averages used is controlled through LD_DIG_PREC. Therefore, when the VCO is frequency locked, LD is high. When the VCO frequency is not locked, LD may pulse high or exhibit periodic behavior.

By default, the internal lock detect signal is made available on the LD terminal. Register bits MUX_CTRL can be used to control a multiplexer to output other diagnostic signals on the LD output.

9.4 Device Functional Modes

9.4.1 Selecting PLL Divider Values

With reference to the PLL architecture shown in [Figure 132](#), operation of the PLL requires TX_DIV_SEL / LO_DIV_SEL, PLL_DIV_SEL, RDIV, NINT, NFRAC and PRSC_SEL bits to be calculated.

a. TX_DIV_SEL / LO_DIV_SEL

The LO to the integrated modulator (f_{TX}) and additional LO output (f_{LO}) frequency is related to f_{VCO} according to the following:

$$f_{TX} = f_{VCO} / \text{TX DIV}$$

$$f_{LO} = f_{VCO} / \text{LO DIV}$$

Where TX DIV and LO DIV are related to TX_DIV_SEL and LO_DIV_SEL as:

TX_DIV_SEL / LO_DIV_SEL	TX_DIV / LO_DIV	Frequency Range
TX_DIV_SEL = 0	TX DIV = 1	$2050 \text{ MHz} \leq f_{TX} \leq 4100 \text{ MHz}$
TX_DIV_SEL = 1	TX DIV = 2	$1025 \text{ MHz} \leq f_{TX} \leq 2050 \text{ MHz}$
TX_DIV_SEL = 2	TX DIV = 4	$512.5 \text{ MHz} \leq f_{TX} \leq 1025 \text{ MHz}$
TX_DIV_SEL = 3	TX DIV = 8	$256.25 \text{ MHz} \leq f_{TX} \leq 512.5 \text{ MHz}$
LO_DIV_SEL = 0	LO DIV = 1	$2050 \text{ MHz} \leq f_{LO} \leq 4100 \text{ MHz}$
LO_DIV_SEL = 1	LO DIV = 2	$1025 \text{ MHz} \leq f_{LO} \leq 2050 \text{ MHz}$
LO_DIV_SEL = 2	LO DIV = 4	$512.5 \text{ MHz} \leq f_{LO} \leq 1025 \text{ MHz}$
LO_DIV_SEL = 3	LO DIV = 8	$256.25 \text{ MHz} \leq f_{LO} \leq 512.5 \text{ MHz}$

b. PLL_DIV_SEL

Given f_{VCO} , select PLL_DIV_SEL so that the division ratio PLL DIV limits the input frequency to the prescaler, f_{DMP} , is limited to a maximum of 3000 MHz.

$$\text{PLL DIV} = \min(1, 2, 4) \text{ such that } f_{DMP} \leq 3000 \text{ MHz}$$

PLL DIV is related to PLL_DIV_SEL according to the following equation:

$$\text{PLL_DIV} = 2^{\text{PLL_DIV_SEL}}$$

This calculation can be restated as [Equation 6](#).

$$\text{PLL DIV} = \text{Ceiling} \left(\frac{\text{LO DIV} \times f_{LO}}{3000 \text{ MHz}} \right) = \text{Ceiling} \left(\frac{\text{TX DIV} \times f_{TX}}{3000 \text{ MHz}} \right) \quad (6)$$

For both integer and fractional mode it is preferable to operate the f_{PFD} at the highest possible frequency determined by the required frequency step of the RFOUT or LO_OUT. In Integer mode, select the maximum f_{PFD} according to [Equation 7](#).

$$f_{PFD} = \frac{f_{VCO, \text{Stepsize}}}{\text{PLL DIV}} = \frac{f_{TX, \text{Stepsize}} \times \text{TX DIV}}{\text{PLL DIV}} \quad (7)$$

In Fractional mode, small RF stepsize can be obtained through the fractional divider. In this case, the highest f_{PFD} frequency should be selected according to the reference clock and system requirements.

c. RDIV, NINT, NFRAC, PRSC_SEL

The remaining PLL parameters are calculated according to the following equations:

$$\text{RDIV} = \frac{f_{\text{REF}}}{f_{\text{PFD}}}$$

$$\text{NINT} = \text{floor} \left(\frac{f_{\text{VCO}} \times \text{RDIV}}{f_{\text{REF}} \times \text{PLL DIV}} \right)$$

$$\text{NFRAC} = \text{floor} \left(\left(\left(\frac{f_{\text{VCO}} \times \text{RDIV}}{f_{\text{REF}} \times \text{PLL DIV}} \right) - \text{NINT} \right) \times 2^{25} \right)$$

The DMP division ratio (P/P+1) can be set to 4/5 or 8/9 through the PRSC_SEL bit. To allow proper fractional operation, set PRSC_SEL according to:

PRSC_SEL = 0, (P/P+1) = 4/5 for 20 ≤ NINT < 72 in integer mode or 23 ≤ NINT < 75 in fractional mode.

PRSC_SEL = 1, (P/P+1) = 8/9 for NINT ≥ 72 in integer mode or NINT ≥ 75 in fractional mode.

The PRSC_SEL limit at NINT < 75 applies to Fractional mode with third-order modulation. In Integer mode, the PRSC_SEL = 8/9 should be used with NINT as low as 72. The divider block accounts for either value of PRSC_SEL without requiring NINT or NFRAC to be adjusted. Then, calculate the maximum input frequency (f_N) to the digital divider. Use the lower of the possible prescaler divide settings, P = (4,8), as shown by [Equation 8](#).

$$f_{\text{N}} = \frac{f_{\text{VCO}}}{\text{PLL DIV} \times \text{P}} \quad (8)$$

Verify that the frequency into the digital divider, f_N, is less than or equal to 375 MHz. If f_N exceeds 375 MHz, choose a larger value for PLL_DIV_SEL and recalculate f_{PFD}, RDIV, NINT, NFRAC, and PRSC_SEL.

9.4.2 Setup Example for Integer Mode

Suppose the following operating characteristics fractional example are desired for Integer mode operation:

- f_{REF} = 61.44 MHz (reference input frequency)
- Step at RF = 2.56 MHz (RF channel spacing)
- f_{RF} = 1799.68 MHz (RF frequency)

The VCO range is 2050 MHz to 4100 MHz. Therefore:

- LO DIV = 2 (LO_DIV_SEL = 1)
- f_{VCO} = LO DIV × 1799.68 MHz = 3599.36 MHz

In order to keep the frequency of the prescaler below 3000 MHz:

- PLL_DIV = 2 (PLL_DIV_SEL = 1)

The desired stepsize at RF is 2.56 MHz, so:

- f_{PFD} = 2.56 MHz
- f_{VCO}, stepsize = PLL_DIV × f_{PFD} = 5.12 MHz

Using the reference frequency along with the required f_{PFD} gives:

- RDIV = 24
- NINT = 703

NINT ≥ 75; therefore, select the 8/9 prescaler.

$$f_{\text{N}} = 3599.36 \text{ MHz} / (2 \times 8) = 224.96 \text{ MHz} < 375 \text{ MHz}$$

This example shows that Integer mode operation gives sufficient resolution for the required stepsize.

9.4.3 Integer and Fractional Mode Selection

The PLL is designed to operate in either Integer mode or Fractional mode. If the desired local oscillator (LO) frequency is an integer multiple of f_{PFD}, then select integer mode otherwise select fractional mode. In Integer mode, the feedback divider ratio is an integer, and the fraction is zero. Thus, bits corresponding to the fractional control in integer mode are *don't care* and fractional divider functionality is disabled.

In Fractional mode, the accuracy of the final frequency is set by 25-bit resolution. The RF stepsize is $f_{\text{PFD}}/2^{25}$ which is less than 1 Hz for f_{PFD} up to 33 MHz. The appropriate fractional control bits in the serial register must be programmed. Optimal performance may require tuning the MOD_ORD, ISOURCE_SINK, and ISOURCE_TRIM values according to the chosen frequency band.

9.4.4 Selecting the VCO and VCO Frequency Control

To achieve a broad frequency tuning range, the TRF3722 integrates multiple VCOs. Each VCO tank uses a bank of coarse tuning capacitor to bring VCO frequency within a few MHz of the desired value. For a given LO frequency an appropriate VCO and capacitor array must be selected. The device integrates logic that automatically selects an appropriate VCO and capacitor array, such that in closed loop $V_{(\text{TUNE})}$ is approximately equal to the open loop calibration reference voltage set by VCO_CAL_REF. An on-chip temperature sensor automatically adjusts this reference voltage so that proper lock can be maintained over the temperature range.

The calibration logic is driven by a CAL_CLK signal which is scaled version of the reference frequency according to CAL_CLK_SEL. For optimum accuracy It is recommended to limit the CAL_CLK frequency to 600 kHz.

When VCO_SEL_MODE is '0', the device automatically selects the VCO and the capacitor array. When VCO_SEL_MODE is '1', the VCO selected by VCO_SEL is used and the logic automatically selects the capacitor array. The VCO and capacitor array settings resulting from the calibration can be read from Register 0 - read back register.

Automatic calibration can be disabled by setting CAL_BYPASS to '1'. In this manual calibration mode, the VCO is selected through register bits VCO_SEL, while the capacitor array is selected through register bits VCO_TRIM. Calibration modes are summarized in [Table 3](#).

Table 3. VCO Calibration Modes

CAL_BYPASS	VCO_SEL_MODE	MAX CYCLES CAL_CLK	VCO	CAPACITOR ARRAY
0	0	46	Automatic	
0	1	34	VCO_SEL	Automatic
1	<i>don't care</i>	N/A	VCO_SEL	VCO_TRIM

9.5 Register Maps

Table 4. Serial interface Register Summary

Bit	Register 1	Register 2	Register 3	Register 4	Register 5	Register 6	
Bit0	Register Address	Register Address	Register Address	Register Address	Register Address	Register Address	
Bit1							
Bit2							
Bit3							
Bit4							
Bit5	RDIV	NINT	NFRAC	PWD_PLL	RSV	RSV	
Bit6				PWD_CP	IB_MOD_GM		
Bit7				PWD_VCO	IB_MOD_LO	VCO_TRIM	
Bit8				PWD_VCO_MUX			
Bit9				PWD_DIV124			
Bit10				PWD_PRESC	VCO_BIAS		
Bit11				RSV			
Bit12				PWD_OUTBUF			
Bit13				PWD_LO_DIV	VCOBUF_BIAS		EN_LOCKDET
Bit14				PWD_TX_DIV			VCO_TEST_MODE
Bit15	PWD_MOD	VCOMUX_BIAS	CAL_BYPASS				
Bit16	EN_EXTVCO		MUX_CTRL				
Bit17	RSV						
Bit18	RSV	OUTBUF_BIAS	ISOURCE_SINKB				
Bit19	REF_INV						
Bit20	NEG_VCO	RSV	ISOURCE_TRIM				
Bit21	ICP			PLL_DIV_SEL			
Bit22		PRSC_SEL					
Bit23		RSV					
Bit24		VCO_SEL	VCO_CAL_REF				
Bit25			VCO_CAL_IB				
Bit26	ICPDOUBLE	VCO_AMPL_CTRL	LO_DIV_SEL				
Bit27	VCO_SEL_MODE		LO_DIV_BIAS				
Bit28	CAL_CLK_SEL	CAL_ACC	TX_DIV_SEL				
Bit29			TX_DIV_BIAS				
Bit30		RSV	EN_LD_ISOURCE	GAIN_CTRL			
Bit31	RSV	EN_CAL	EN_FRAC_MODE	EN_LD_ISOURCE			

9.5.1 Serial interface Register Definition

Table 5. Register 1

Register 1	Bit Name	Reset Value	Description
Bit0	ADDR<0>	1	Register Address Bits
Bit1	ADDR<1>	0	
Bit2	ADDR<2>	0	
Bit3	ADDR<3>	1	
Bit4	ADDR<4>	0	
Bit5	RDIV<0>	1	13-bit Reference Divider Value (Rmin = 1, Rmax = 8191)
Bit6	RDIV<1>	0	
Bit7	RDIV<2>	0	
Bit8	RDIV<3>	0	
Bit9	RDIV<4>	0	
Bit10	RDIV<5>	0	
Bit11	RDIV<6>	0	
Bit12	RDIV<7>	0	
Bit13	RDIV<8>	0	
Bit14	RDIV<9>	0	
Bit15	RDIV<10>	0	
Bit16	RDIV<11>	0	
Bit17	RDIV<12>	0	
Bit18	RSV	0	Reserved
Bit19	REF_INV	0	Invert Reference Clock Polarity; 1 = use falling edge
Bit20	NEG_VCO	1	VCO polarity control; 1 = negative slope (negative Kv)
Bit21	ICP<0>	0	Program charge pump DC current: [00000] = 1.94 mA [11111] = 0.47 mA [01010] = 0.97 mA
Bit22	ICP<1>	1	
Bit23	ICP<2>	0	
Bit24	ICP<3>	1	
Bit25	ICP<4>	0	
Bit26	ICPDOUBLE	0	1 = Set ICP to double the current
Bit27	CAL_CLK_SEL<0>	0	Multiplication or division factor to create VCO calibration clock from the PFD frequency: [0000] = Fastest (Rdiv / 128) [1111] = Slowest (Rdiv x 128), [1000] = Default (1x Rdiv)
Bit28	CAL_CLK_SEL<1>	0	
Bit29	CAL_CLK_SEL<2>	0	
Bit30	CAL_CLK_SEL<3>	1	
Bit31	RSV	0	Reserved

CAL_CLK_SEL[3..0]: Set the frequency divider value used to derive the VCO calibration clock from the reference frequency.

Table 6. CAL_CLK_SEL Scaling Factor Setting

CAL_CLK_SEL	Scaling Factor	CAL_CLK_SEL	Scaling Factor
1111	1/128	0111	NA
1110	1/64	0110	2
1101	1/32	0101	4
1100	1/16	0100	8
1011	1/8	0011	16
1010	1/4	0010	32
1001	1/2	0001	64
1000	1	0000	128

ICP[4..0]: Set the charge pump current.

Table 7. Charge Pump Current Set-Point

ICP[4..0]	Current (mA)	ICP[4..0]	Current (mA)
00 000	1.94	10 000	0.75
00 001	1.76	10 001	0.72
00 010	1.62	10 010	0.69
00 011	1.49	10 011	0.67
00 100	1.38	10 100	0.65
00 101	1.29	10 101	0.63
00 110	1.21	10 110	0.61
00 111	1.14	10 111	0.59
01 000	1.08	11 000	0.57
01 001	1.02	11 001	0.55
01 010	0.97	11 010	0.54
01 011	0.92	11 011	0.52
01 100	0.88	11 100	0.51
01 101	0.84	11 101	0.50
01 110	0.81	11 110	0.48
01 111	0.78	11 111	0.47

Table 8. Register 2

Register 2	Bit Name	Reset Value	Description
Bit0	ADDR<0>	0	Register Address Bits
Bit1	ADDR<1>	1	
Bit2	ADDR<2>	0	
Bit3	ADDR<3>	1	
Bit4	ADDR<4>	0	
Bit5	NINT<0>	0	PLL N-Divider Value
Bit6	NINT<1>	0	
Bit7	NINT<2>	0	
Bit8	NINT<3>	0	
Bit9	NINT<4>	0	
Bit10	NINT<5>	0	
Bit11	NINT<6>	0	
Bit12	NINT<7>	1	
Bit13	NINT<8>	0	
Bit14	NINT<9>	0	
Bit15	NINT<10>	0	
Bit16	NINT<11>	0	
Bit17	NINT<12>	0	
Bit18	NINT<13>	0	
Bit19	NINT<14>	0	
Bit20	NINT<15>	0	
Bit21	PLL_DIV_SEL<0>	1	Select division ratio of divider in front of prescaler [00] = 1X, [01] = div2, [10] = div4
Bit22	PLL_DIV_SEL<1>	0	
Bit23	PRSC_SEL	1	Select precaler modulus: [0] = 4/5, [1] = 8/9
Bit24	RSV	0	Reserved
Bit25	RSV	0	
Bit26	VCO_SEL<0>	0	Selects between the four integrated VCOs [00] = lowest frequency, [11] = highest frequency
Bit27	VCO_SEL<1>	1	
Bit28	VCO_SEL_MODE	0	Single VCO auto-calibration mode: [1] = active
Bit29	CAL_ACC<0>	0	Error count during the cap array calibration [00] = 0, [01] = 1/32, [10] = 1/64, [11] = 1/128
Bit30	CAL_ACC<1>	0	
Bit31	EN_CAL	0	Initiate VCO auto-calibration, resets automatically

Table 9. Register 3

Register 3	Bit Name	Reset Value	Description
Bit0	ADDR<0>	1	Register Address Bits
Bit1	ADDR<1>	1	
Bit2	ADDR<2>	0	
Bit3	ADDR<3>	1	
Bit4	ADDR<4>	0	
Bit5	NFRAC<0>	0	Fractional PLL N-Divider 0 to 0.99999 in fractional mode
Bit6	NFRAC<1>	0	
Bit7	NFRAC<2>	0	
Bit8	NFRAC<3>	0	
Bit9	NFRAC<4>	0	
Bit10	NFRAC<5>	0	
Bit11	NFRAC<6>	0	
Bit12	NFRAC<7>	0	
Bit13	NFRAC<8>	0	
Bit14	NFRAC<9>	0	
Bit15	NFRAC<10>	0	
Bit16	NFRAC<11>	0	
Bit17	NFRAC<12>	0	
Bit18	NFRAC<13>	0	
Bit19	NFRAC<14>	0	
Bit20	NFRAC<15>	0	
Bit21	NFRAC<16>	0	
Bit22	NFRAC<17>	0	
Bit23	NFRAC<18>	0	
Bit24	NFRAC<19>	0	
Bit25	NFRAC<20>	0	
Bit26	NFRAC<21>	0	
Bit27	NFRAC<22>	0	
Bit28	NFRAC<23>	0	
Bit29	NFRAC<24>	0	
Bit30	RSV	0	Reserved
Bit31	RSV	0	

Table 10. Register 4

Register 4	Bit Name	Reset Value	Description
Bit0	ADDR<0>	0	Register Address Bits
Bit1	ADDR<1>	0	
Bit2	ADDR<2>	1	
Bit3	ADDR<3>	1	
Bit4	ADDR<4>	0	
Bit5	PWD_PLL	0	Power -down all PLL blocks: (1 = off)
Bit6	PWD_CP	0	Power-down Charge Pump: (1=off)
Bit7	PWD_VCO	0	Power-down VCO: (1=off)
Bit8	PWD_VCO_MUX	0	Power-down VCO Mux blocks: (1=off)
Bit9	PWD_DIV124	0	Power-down the div 1,2,4 in the PLL f/b path: (1=off)
Bit10	PWD_PRESC	0	Power-down Prescaler: (1=off)
Bit11	RSV	1	Reserved
Bit12	PWD_OUTBUF	1	Power-down Ouput Buffer: (1=off)
Bit13	PWD_LO_DIV	1	Power-down LO divider block: (1=off)
Bit14	PWD_TX_DIV	1	Power-down TX divider block: (1=off)
Bit15	PWD_MOD	1	Power-down modulator block: (1=off)
Bit16	EN_EXTVCO	0	Enable external VCO input buffer: (1 = enabled)
Bit17	RSV	0	Reserved
Bit18	EN_ISOURCE	0	Enable offset current at CP output (frac-n mode only).
Bit19	LD_ANA_PREC<0>	0	Control precision of Analog Lock Detector: [00] = H/H (High), [01] = L/L (Low), [10] = H/L , [11] = L/L
Bit20	LD_ANA_PREC<1>	0	
Bit21	CP_TRISTATE<0>	0	Set the charge pump output in Tristate mode: [00] = Off, [01] = Down, [10] = Up, [11] = Tristate
Bit22	CP_TRISTATE<1>	0	
Bit23	SPEEDUP	0	Enable fast turn on/off time of bias blocks.
Bit24	LD_DIG_PREC	0	Lock detector precision (increases sampling time if set to 1)
Bit25	MOD_ORD<0>	1	Modulator order (1-4). Not used in integer mode (default 3rd order + dither)
Bit26	MOD_ORD<1>	0	
Bit27	MOD_ORD<2>	1	
Bit28	DITH_SEL	0	Dither Mode: [0] = pseudo-random, [1] = constant
Bit29	DEL_SD_CLK<0>	0	DS modulator clock delay. Frac-n mode only. [00] = Min delay, [11] = max delay
Bit30	DEL_SD_CLK<1>	1	
Bit31	EN_FRAC_MODE	0	Enable Frac-n mode when set to 1

Table 11. Register 5

Register 5	Bit Name	Reset Value	Description
Bit0	ADDR<0>	1	Register Address Bits
Bit1	ADDR<1>	0	
Bit2	ADDR<2>	1	
Bit3	ADDR<3>	1	
Bit4	ADDR<4>	0	
Bit5	RSV	0	Reserved
Bit6	IB_MOD_GM<0>	0	Adjust modulator bias current gm
Bit7	IB_MOD_GM<1>	1	
Bit8	IB_MOD_LO<0>	0	Adjust modulator BB and LO bias current
Bit9	IB_MOD_LO<1>	1	
Bit10	VCO_BIAS<0>	0	Adjust VCO bias reference current
Bit11	VCO_BIAS<1>	0	
Bit12	VCO_BIAS<2>	0	
Bit13	VCO_BIAS<3>	1	
Bit14	VCOBUF_BIAS<0>	0	Adjust VCO buffer reference current
Bit15	VCOBUF_BIAS<1>	1	
Bit16	VCOMUX_BIAS<0>	0	Adjust VCO Mux reference current
Bit17	VCOMUX_BIAS<1>	1	
Bit18	OUTBUF_BIAS<0>	0	Adjust output buffer current
Bit19	OUTBUF_BIAS<1>	1	
Bit20	RSV	0	Reserved
Bit21	RSV	1	
Bit22	VCO_CAL_IB	0	Bias current for CAL reference voltage: [0] = PTAT, [1] = Constant
Bit23	VCO_CAL_REF<0>	0	VCO calibration reference voltage adjustment [000] = 0.9 V, [111] = 1.4 V [011] = recommended = 1.11 V
Bit24	VCO_CAL_REF<1>	0	
Bit25	VCO_CAL_REF<2>	1	
Bit26	VCO_AMPL_CTRL<0>	0	Adjusts the signal level at the VCO_MUX input: [00] =max, [11] = min
Bit27	VCO_AMPL_CTRL<1>	1	
Bit28	VCO_VB_CTRL<0>	0	Adjusts the VCO core bias voltage: [00] = 1.2 V, [01] = 1.35 V, [10] = 1.5 V, [11] = 1.65 V
Bit29	VCO_VB_CTRL<1>	1	
Bit30	RSV	0	Reserved
Bit31	EN_LD_MON_ISOURCE	1	Enable monitoring of LD to turn on Isource; recommend [0] = Isource ctrl

Table 12. Register 6

Register 6	Bit Name	Reset Value	Description
Bit0	ADDR<0>	0	Register Address Bits
Bit1	ADDR<1>	1	
Bit2	ADDR<2>	1	
Bit3	ADDR<3>	1	
Bit4	ADDR<4>	0	
Bit5	RSV	0	Reserved
Bit6	RSV	0	
Bit7	VCO_TRIM<0>	0	VCO capacitor array control bits; used in manual cal mode
Bit8	VCO_TRIM<1>	0	
Bit9	VCO_TRIM<2>	0	
Bit10	VCO_TRIM<3>	0	
Bit11	VCO_TRIM<4>	0	
Bit12	VCO_TRIM<5>	1	
Bit13	EN_LOCKDET	0	Enable monitor of lock detector output for autocal mode
Bit14	VCO_TEST_MODE	0	Counter mode, measure max and min freq for each VCO
Bit15	CAL_BYPASS	0	Bypass auto-cal; sets VCO_SEL and VCO_TRIM from Serial interface
Bit16	MUX_CTRL<0>	1	Select signal for test output: [001] = LD, [010] = NDIV, [100] = RDIV, [110] = A_counter
Bit17	MUX_CTRL<1>	0	
Bit18	MUX_CTRL<2>	0	
Bit19	ISOURCE_SINKB	0	Offset current polarity
Bit20	ISOURCE_TRIM<0>	0	Adjust Isource bias current in frac-n mode.
Bit21	ISOURCE_TRIM<1>	0	
Bit22	ISOURCE_TRIM<2>	1	
Bit23	LO_DIV_SEL<0>	0	Adjust LO path divider: [00] = Div/1, [01] = Div/2, [10] = Div/4. [11] = Div/8
Bit24	LO_DIV_SEL<1>	0	
Bit25	LO_DIV_BIAS<0>	0	Adjust LO divider bias current: [00] = 25 uA, [01] = 37.5 uA, [10] = 50 uA, [11] = 62.5 uA
Bit26	LO_DIV_BIAS<1>	1	
Bit27	TX_DIV_SEL<0>	0	Adjust TX path divider.
Bit28	TX_DIV_SEL<1>	1	[00] = Div/1, [01] = Div/2, [10] = Div/4. [11] = Div/8
Bit29	TX_DIV_BIAS<0>	0	Adjust TX divider bias current: [00] = 25 uA, [01] = 37.5 uA, [10] = 50 uA, [11] = 62.5 uA
Bit30	TX_DIV_BIAS<1>	1	
Bit31	GAIN_CTRL	0	Modulator gain control: [0] = Default, [1] = High Gain

Table 13. READBACK Mode Summary Serial interface Map

Bit	Register 0	RDBK	
Bit0	Register Address	Register Address	
Bit1			
Bit2			
Bit3			
Bit4			
Bit5	CHIP_ID	N/C	
Bit6			
Bit7	NU		
Bit8			
Bit9			
Bit10			
Bit11			
Bit12	R_SAT_ERR		
Bit13	COUNT		N/C
Bit14			
Bit15			
Bit16		VCO_TRIM	
Bit17			
Bit18			
Bit19			
Bit20			
Bit21		VCO_SEL	
Bit22			
Bit23			
Bit24			
Bit25			
Bit26			
Bit27	MUX_COUNT		
Bit28	RB_REG		
Bit29			
Bit30			
Bit31	MUX_COUNT		
	RB_ENABLE		

Table 14. Register 0 (Readback Only)

Register 0	Bit Name	Reset Value	Description
Bit0	ADDR<0>	0	Register Address Bits
Bit1	ADDR<1>	0	
Bit2	ADDR<2>	0	
Bit3	ADDR<3>	1	
Bit4	ADDR<4>	0	
Bit5	CHIP_ID<0>	1	Chip ID
Bit6	CHIP_ID<1>	0	
Bit7	NU	x	Not Used
Bit8	NU	x	
Bit9	NU	x	
Bit10	NU	x	
Bit11	NU	x	
Bit12	R_SAT_ERR	x	R-div saturation error for cal
Bit13	COUNT<0>/NU	x	VCO frequency counter high when MUX_COUNT = 0 and VCO_TEST_MODE = 1 VCO frequency counter low when MUX_COUNT = 1 and VCO_TEST_MODE = 1 Autocal results for VCO_TRIM and VCO_SEL when VCO_TEST_MODE = 0
Bit14	COUNT<1>/NU	x	
Bit15	COUNT<2>/VCO_TRIM<0>	x	
Bit16	COUNT<3>/VCO_TRIM<1>	x	
Bit17	COUNT<4>/VCO_TRIM<2>	x	
Bit18	COUNT<5>/VCO_TRIM<3>	x	
Bit19	COUNT<6>/VCO_TRIM<4>	x	
Bit20	COUNT<7>/VCO_TRIM<5>	x	
Bit21	COUNT<8>/VCO_SEL<0>	x	
Bit22	COUNT<9>/VCO_SEL<1>	x	
Bit23	COUNT<10>/VCO_SEL<2>	x	
Bit24	COUNT<11>	x	
Bit25	COUNT<12>	x	
Bit26	COUNT<13>	x	
Bit27	COUNT<14>	x	
Bit28	COUNT<15>	x	
Bit29	COUNT<16>	x	
Bit30	COUNT<17>	x	
Bit31	MUX_COUNT	x	[0] = max freq count, [1] = min freq count

Table 15. Register RDBK (Write Register for Readback)

RDBK	Bit Name	Reset Value	Description
Bit0	ADDR<0>	0	Register Address Bits
Bit1	ADDR<1>	0	
Bit2	ADDR<2>	0	
Bit3	ADDR<3>	1	
Bit4	ADDR<4>	0	
Bit5	N/C	0	
Bit6	N/C	0	
Bit7	N/C	0	
Bit8	N/C	0	
Bit9	N/C	0	
Bit10	N/C	0	
Bit11	N/C	0	
Bit12	N/C	0	
Bit13	N/C	0	
Bit14	N/C	0	
Bit15	N/C	0	
Bit16	N/C	0	
Bit17	N/C	0	
Bit18	N/C	0	
Bit19	N/C	0	
Bit20	N/C	0	
Bit21	N/C	0	
Bit22	N/C	0	
Bit23	N/C	0	
Bit24	N/C	0	
Bit25	N/C	0	
Bit26	N/C	0	
Bit27	MUX_COUNT	0	[0] = max freq count, [1] = min freq count
Bit28	RB_REG<0>	x	Three LSBs of the address for the register that is being read: [001] = Register 1 [110] = Register 6
Bit29	RB_REG<1>	x	
Bit30	RB_REG<2>	x	
Bit31	RB_ENABLE	1	Puts device in Readback mode

9.5.1.1 BIAS SETTINGS

Optimum TRF3722 bias settings used in the performance measurements are shown in [Table 16](#).

Table 16. Register Settings With Optimized Bias Set Used in the Performance Measurement.

REGISTER	BITS	TYPICAL OPERATING MODE [256MHz-2GHz], INT MODE	TYPICAL OPERATING MODE [2GHz - 3GHz], INT MODE	TYPICAL OPERATING MODE [3GHz - 4.1GHz], INT MODE	LOW POWER MODE, INT MODE	FRACTIONAL MODE
REGISTER 1	RDIV	x	x	x	x	x
REGISTER 1	REF_INV	0	0	0	0	0
REGISTER 1	NEG_VCO	1	1	1	1	1
REGISTER 1	ICP	0	0	0	0	0
REGISTER 1	ICPDOUBLE	0	0	0	0	0
REGISTER 1	CAL_CLK_SEL	13	13	13	13	15
REGISTER 2	NINT	x	x	x	x	x
REGISTER 2	PLL_DIV_SEL	x	x	x	x	x
REGISTER 2	PRSC_SEL	x	x	x	x	x
REGISTER 2	VCO_SEL	x	x	x	x	x
REGISTER 2	VCO_SEL_MODE	x	x	x	x	x
REGISTER 2	CAL_ACC	0	0	0	0	0
REGISTER 2	EN_CAL	1	1	1	1	1
REGISTER 3	NFRAC	0	0	0	0	x
REGISTER 4	PWD_PLL	0	0	0	0	0
REGISTER 4	PWD_CP	0	0	0	0	0
REGISTER 4	PWD_VCO	0	0	0	0	0
REGISTER 4	PWD_VCO_MUX	0	0	0	0	0
REGISTER 4	PWD_DIV124	0	0	0	0	0
REGISTER 4	PWD_PRESC	0	0	0	0	0
REGISTER 4	PWD_OUTBUF	0	0	0	1	0
REGISTER 4	PWD_LO_DIV	0	0	0	1	0
REGISTER 4	PWD_TX_DIV	0	0	0	0	0
REGISTER 4	PWD_MOD	0	0	0	0	0
REGISTER 4	EN_EXTVCO	0	0	0	0	0
REGISTER 4	EN_ISOURCE	0	0	0	0	1
REGISTER 4	LD_ANA_PREC	0	0	0	0	3
REGISTER 4	CP_TRISTATE	0	0	0	0	0
REGISTER 4	SPEEDUP	0	0	0	0	0
REGISTER 4	LD_DIG_PREC	0	0	0	0	0
REGISTER 4	MOD_ORD	5	5	5	5	4
REGISTER 4	DITH_SEL	0	0	0	0	0
REGISTER 4	DEL_SD_CLK	2	2	2	2	0
REGISTER 4	EN_FRAC_MODE	0	0	0	0	1
REGISTER 5	IB_MOD_GM	3	3	2	0	3
REGISTER 5	IB_MOD_LO	0	1	0	0	0
REGISTER 5	VCO_BIAS	15	15	15	15	15
REGISTER 5	VCBUF_BIAS	2	2	2	2	2
REGISTER 5	OUTBUF_BIAS	2	2	2	0	2
REGISTER 5	VCOMUX_BIAS	2	2	2	2	2
REGISTER 5	VCO_CAL_IB	0	0	0	0	0
REGISTER 5	VCO_CAL_REF	3	3	3	3	3
REGISTER 5	VCO_AMPL_CTRL	0	0	0	0	0
REGISTER 5	VCO_VB_CTRL	3	3	3	3	3
REGISTER 5	EN_LD_ISOURCE	0	0	0	0	0

Table 16. Register Settings With Optimized Bias Set Used in the Performance Measurement. (continued)

REGISTER	BITS	TYPICAL OPERATING MODE [256MHz-2GHz], INT MODE	TYPICAL OPERATING MODE [2GHz - 3GHz], INT MODE	TYPICAL OPERATING MODE [3GHz - 4.1GHz], INT MODE	LOW POWER MODE, INT MODE	FRACTIONAL MODE
REGISTER 6	VCO_TRIM	x	x	x	x	x
REGISTER 6	EN_LOCKDET	0	0	0	0	0
REGISTER 6	VCO_TEST_MODE	0	0	0	0	0
REGISTER 6	CAL_BYPASS	0	0	0	0	0
REGISTER 6	MUX_CTRL	1	1	1	1	5
REGISTER 6	ISOURCE_SINKB	0	0	0	0	0
REGISTER 6	ISOURCE_TRIM	4	4	4	4	7
REGISTER 6	LO_DIV_SEL	x	x	x	x	x
REGISTER 6	LO_DIV_BIAS	2	2	2	0	2
REGISTER 6	TX_DIV_SEL	x	x	x	x	x
REGISTER 6	TX_DIV_BIAS	1	1	1	0	1
REGISTER 6	GAIN_CTRL	0	0	0	0	0

10 Applications and Implementation

10.1 Application Information

Figure 135 illustrates a typical application schematic for the TRF3722.

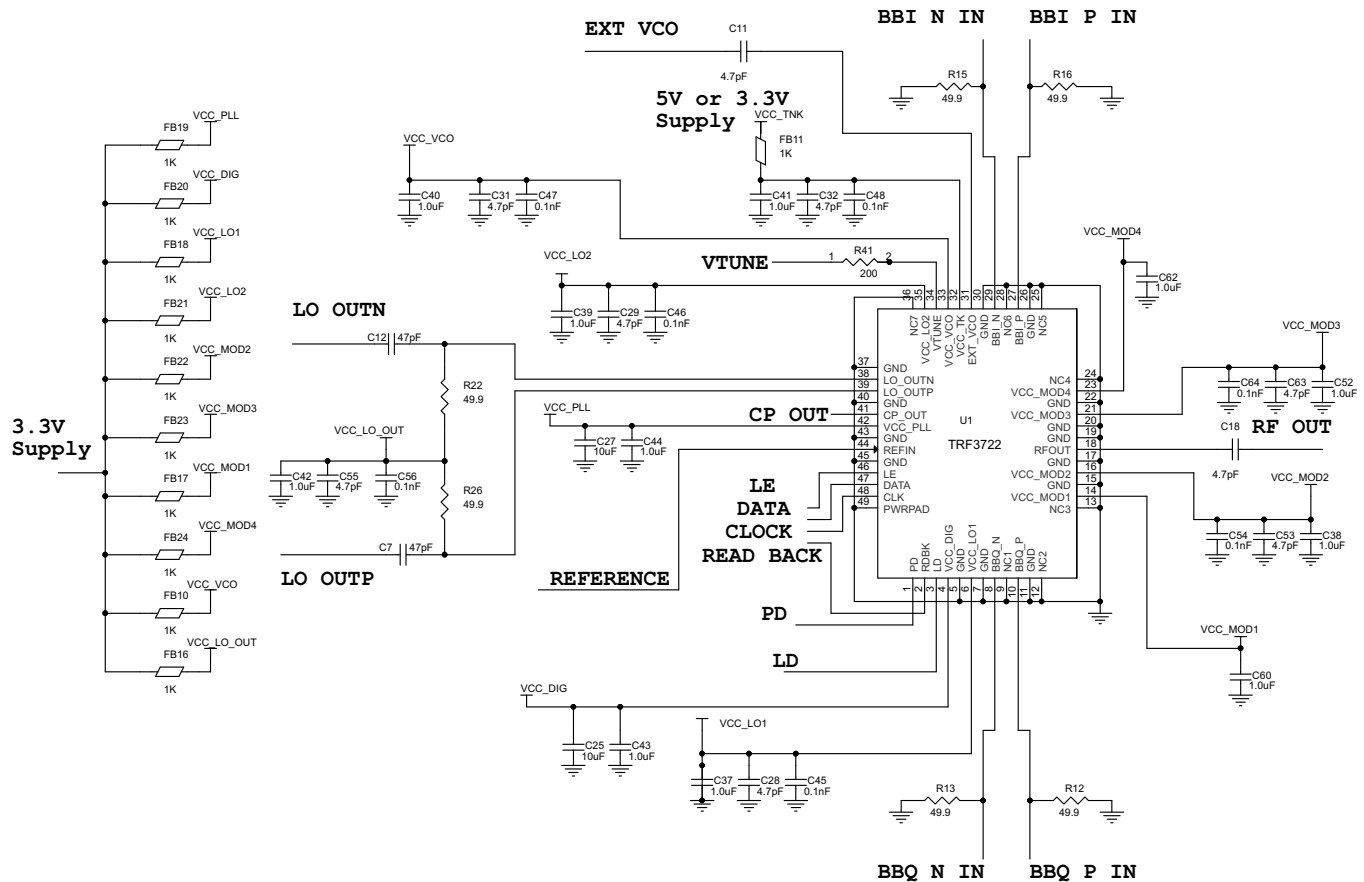

Figure 135. TRF3722 Application Schematic

10.1.1 Design Requirements

Table 17 lists the pin termination requirements and interfacing for the circuit.

Table 17. Termination Requirements and Interfacing

PIN	NAME	DESCRIPTION
47	DATA	4WI data input: digital input, high impedance
2	RDBK	Readback output; digital output pins can source or sink up to 8 mA of current
3	LD	Lock detector digital output, as configured by MUX_CTRL
8,10,27,29	BBI_P, BBI_N, BBQ_P, BBQ_N	In-phase and quadrature baseband differential baseband signals. Typical 0.25V common mode is needed
18	RFOUT	Modulator RF output: must be ac-coupled and can drive 50 Ω load
31	EXT_VCO	External local oscillator input: high impedance, normally ac-coupled. If unused terminate to 50 ohms load
38,39	LO_OUTP, LO_OUTN	Local oscillator output: open-collector output. A pull-up resistor is LO_OUT required, normally ac-coupled.
44	REFIN	Reference clock input: high impedance, normally ac-coupled
46	LE	Serial interface latch enable: digital input, high impedance
48	CLK	Serial interface clock input: digital input, high impedance
47	DATA	Serial interface data input: digital input, high impedance

10.1.2 Detailed Design Procedures, DAC to Modulator Interface Network

Digital-to-analog converter (DAC) can interface directly with the TRF3722 modulator. The common-mode voltage of the DAC and the modulator baseband inputs should be properly maintained. With the proper interface network, the common-mode voltage of the DAC can be translated to the proper common-mode voltage of the modulator. The TRF3722 common-mode voltage is typically 0.25 V, and is ideally suited to interface with the [DAC3482/3484](#) (DAC348x) and DAC38J8x family. The interface network is shown in [Figure 136](#).

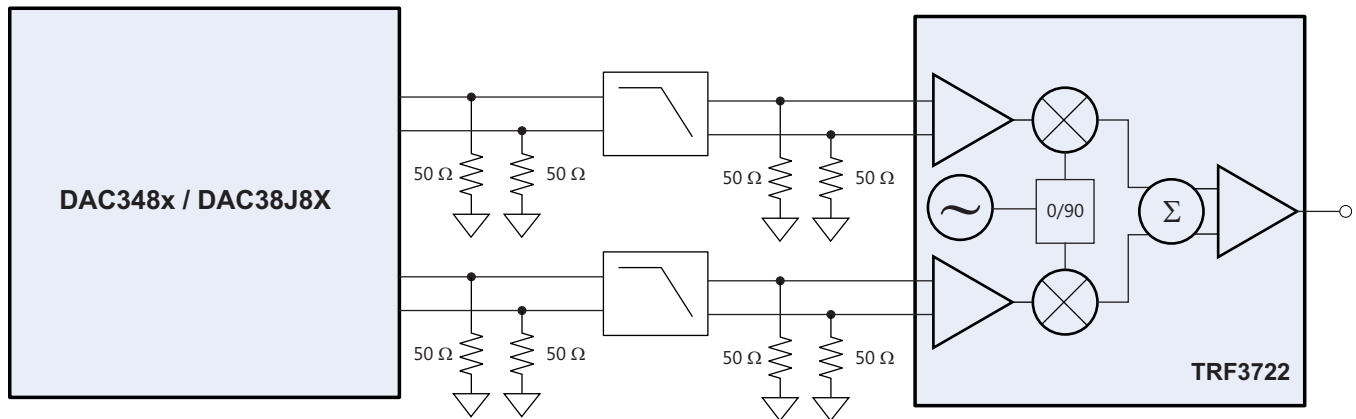

Figure 136. DAC348x Interface with the TRF3722 Modulator

The DAC348x requires a load resistance of 25 Ω per branch to maintain its optimum voltage swing of $1-V_{PP}$ differential with a 20-mA max current setting. The load of the DAC is separated into two parallel 50- Ω resistors placed on the input and output side of the low-pass filter. This configuration provides the proper resistive load to the DAC while also providing a convenient 50- Ω source and load termination for the filter.

10.1.3 Application Curves, DAC34H84 with TRF3722 Modulator Performance

The cascaded combination of the DAC34H84 and TRF3722 modulator yields excellent system parameters suitable for high-performance applications. Figure 137 and Figure 138 shows 152.9 MHz IF adjacent channel power ratio (ACPR) performance.

- Mode integer
- PFD: 3.2 MHz
- Reference: 153.6 MHz
- LO = 1689.6 MHz
- IF = 152.9 MHz
- RF= 1842.5 MHz

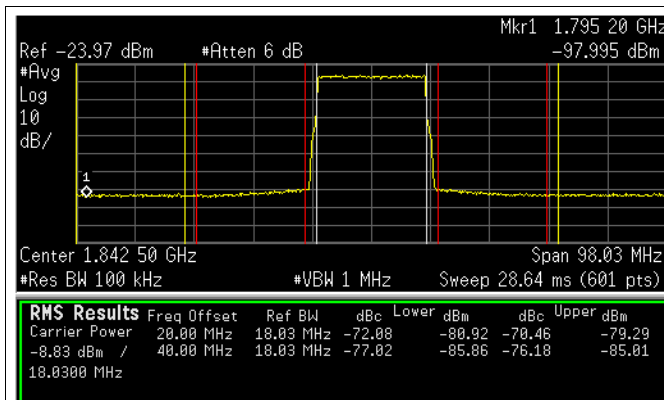

Figure 137. 152.9 MHz IF, DAC34H84 + TRF3722 20 MHz LTE ACPR

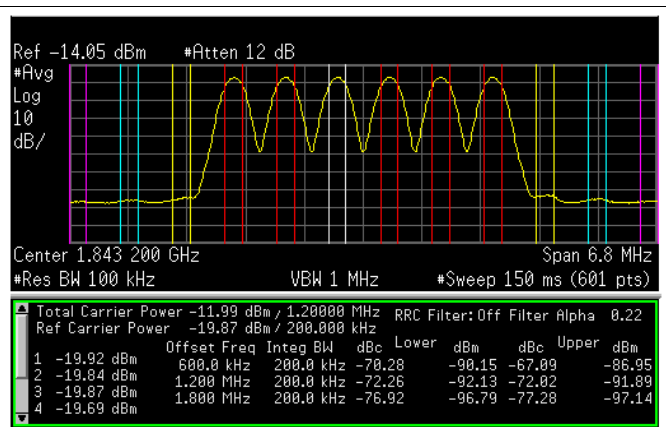

Figure 138. 152.9 MHz IF, 6 Carrier MC-GSM DAC34H84 + TRF3722 ACPR Performance

11 Power Supply Recommendations

The TRF3722 is powered by supplying a nominal 3.3 V and 5 V. It can also be powered using only 3.3V supply. Proper RF bypassing should be placed close to each power supply pin. Ground pin connections should have at least one ground via close to each ground pin to minimize ground inductance. The PowerPAD™ must be tied to ground, preferably with the recommended ground via pattern to provide a good thermal conduction path to the alternate side of the board and to provide a good RF ground for the device. (Refer to [Layout Guidelines](#) section for additional information.)

12 Layout

12.1 Layout Guidelines

Layout of the application board significantly impacts the analog performance of the TRF3722 device. Noise and high-speed signals should be prevented from leaking onto power-supply terminals or analog signals. The TRF3722 device is fitted with a ground slug on the back of the package that must be soldered to the printed circuit board (PCB) ground with adequate ground vias to ensure a good thermal and electrical connection. The ground pins of the device can be directly tied to the ground slug pad for a low-inductance path to ground. Additional ground vias may be added if space allows. Follow these recommendations:

- Place supply decoupling capacitors physically close to the device, on the same side of the board. Isolate supply terminals with a ferrite bead.
- Maintain a continuous ground plane in the vicinity of the device and as return paths for all high-speed signal lines. Place reference plane vias or decoupling capacitors near any signal line reference transition.
- Power planes should not overlap each other or high-speed signal lines.
- Isolate REFIN routing from loop filter lines, control lines, and other high-speed lines.

12.2 Layout Example

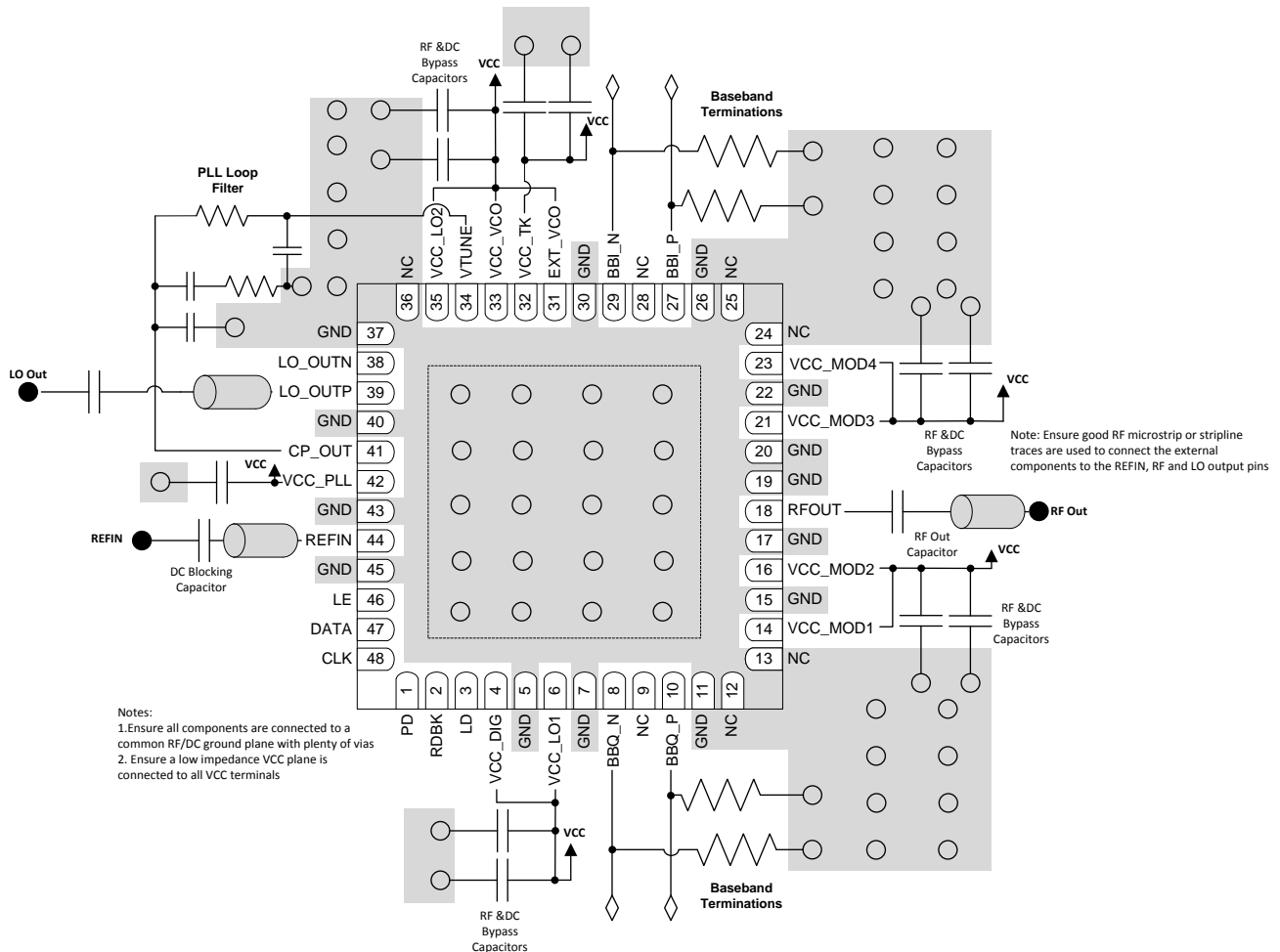

Figure 139. Layout

13 Device and Documentation Support

13.1 Trademarks

PowerPAD is a trademark of Texas Instruments.
All other trademarks are the property of their respective owners.

13.2 Electrostatic Discharge Caution



These devices have limited built-in ESD protection. The leads should be shorted together or the device placed in conductive foam during storage or handling to prevent electrostatic damage to the MOS gates.

13.3 Glossary

[SLYZ022](#) — *TI Glossary*.

This glossary lists and explains terms, acronyms, and definitions.

14 Mechanical, Packaging, and Orderable Information

The following pages include mechanical, packaging, and orderable information. This information is the most current data available for the designated devices. This data is subject to change without notice and revision of this document. For browser-based versions of this data sheet, refer to the left-hand navigation.

PACKAGING INFORMATION

Orderable Device	Status (1)	Package Type	Package Drawing	Pins	Package Qty	Eco Plan (2)	Lead/Ball Finish (6)	MSL Peak Temp (3)	Op Temp (°C)	Device Marking (4/5)	Samples
TRF3722IRGZR	ACTIVE	VQFN	RGZ	48	2500	Green (RoHS & no Sb/Br)	CU NIPDAU	Level-2-260C-1 YEAR	-40 to 85	TRF3722 IRGZ	Samples
TRF3722IRGZT	ACTIVE	VQFN	RGZ	48	250	Green (RoHS & no Sb/Br)	CU NIPDAU	Level-2-260C-1 YEAR	-40 to 85	TRF3722 IRGZ	Samples

(1) The marketing status values are defined as follows:

ACTIVE: Product device recommended for new designs.

LIFEBUY: TI has announced that the device will be discontinued, and a lifetime-buy period is in effect.

NRND: Not recommended for new designs. Device is in production to support existing customers, but TI does not recommend using this part in a new design.

PREVIEW: Device has been announced but is not in production. Samples may or may not be available.

OBSELETE: TI has discontinued the production of the device.

(2) Eco Plan - The planned eco-friendly classification: Pb-Free (RoHS), Pb-Free (RoHS Exempt), or Green (RoHS & no Sb/Br) - please check <http://www.ti.com/productcontent> for the latest availability information and additional product content details.

TBD: The Pb-Free/Green conversion plan has not been defined.

Pb-Free (RoHS): TI's terms "Lead-Free" or "Pb-Free" mean semiconductor products that are compatible with the current RoHS requirements for all 6 substances, including the requirement that lead not exceed 0.1% by weight in homogeneous materials. Where designed to be soldered at high temperatures, TI Pb-Free products are suitable for use in specified lead-free processes.

Pb-Free (RoHS Exempt): This component has a RoHS exemption for either 1) lead-based flip-chip solder bumps used between the die and package, or 2) lead-based die adhesive used between the die and leadframe. The component is otherwise considered Pb-Free (RoHS compatible) as defined above.

Green (RoHS & no Sb/Br): TI defines "Green" to mean Pb-Free (RoHS compatible), and free of Bromine (Br) and Antimony (Sb) based flame retardants (Br or Sb do not exceed 0.1% by weight in homogeneous material)

(3) MSL, Peak Temp. - The Moisture Sensitivity Level rating according to the JEDEC industry standard classifications, and peak solder temperature.

(4) There may be additional marking, which relates to the logo, the lot trace code information, or the environmental category on the device.

(5) Multiple Device Markings will be inside parentheses. Only one Device Marking contained in parentheses and separated by a "~" will appear on a device. If a line is indented then it is a continuation of the previous line and the two combined represent the entire Device Marking for that device.

(6) Lead/Ball Finish - Orderable Devices may have multiple material finish options. Finish options are separated by a vertical ruled line. Lead/Ball Finish values may wrap to two lines if the finish value exceeds the maximum column width.

Important Information and Disclaimer: The information provided on this page represents TI's knowledge and belief as of the date that it is provided. TI bases its knowledge and belief on information provided by third parties, and makes no representation or warranty as to the accuracy of such information. Efforts are underway to better integrate information from third parties. TI has taken and continues to take reasonable steps to provide representative and accurate information but may not have conducted destructive testing or chemical analysis on incoming materials and chemicals. TI and TI suppliers consider certain information to be proprietary, and thus CAS numbers and other limited information may not be available for release.

In no event shall TI's liability arising out of such information exceed the total purchase price of the TI part(s) at issue in this document sold by TI to Customer on an annual basis.

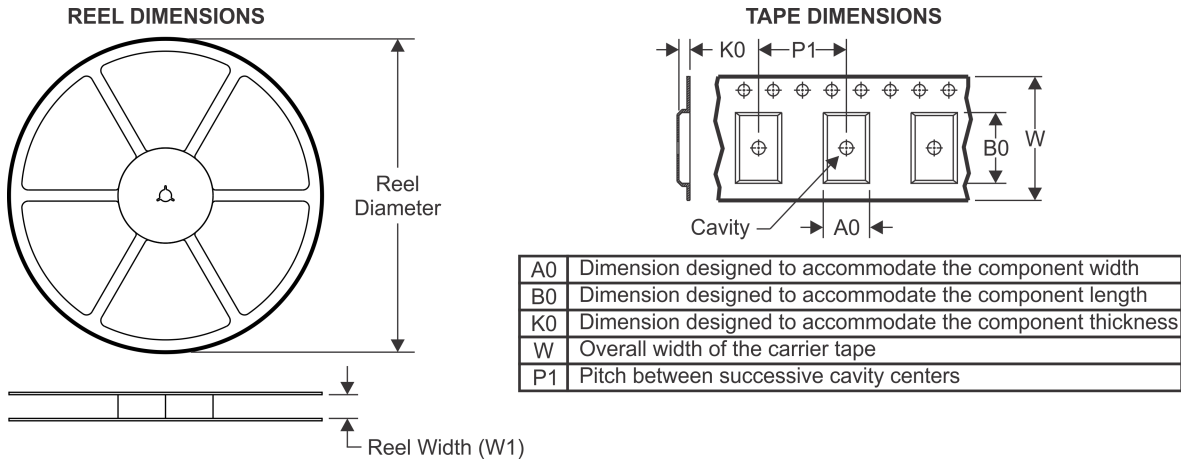
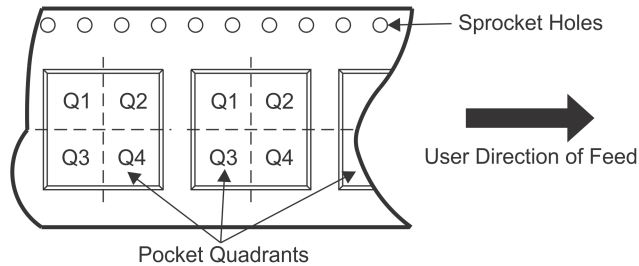
TAPE AND REEL INFORMATION

QUADRANT ASSIGNMENTS FOR PIN 1 ORIENTATION IN TAPE

*All dimensions are nominal

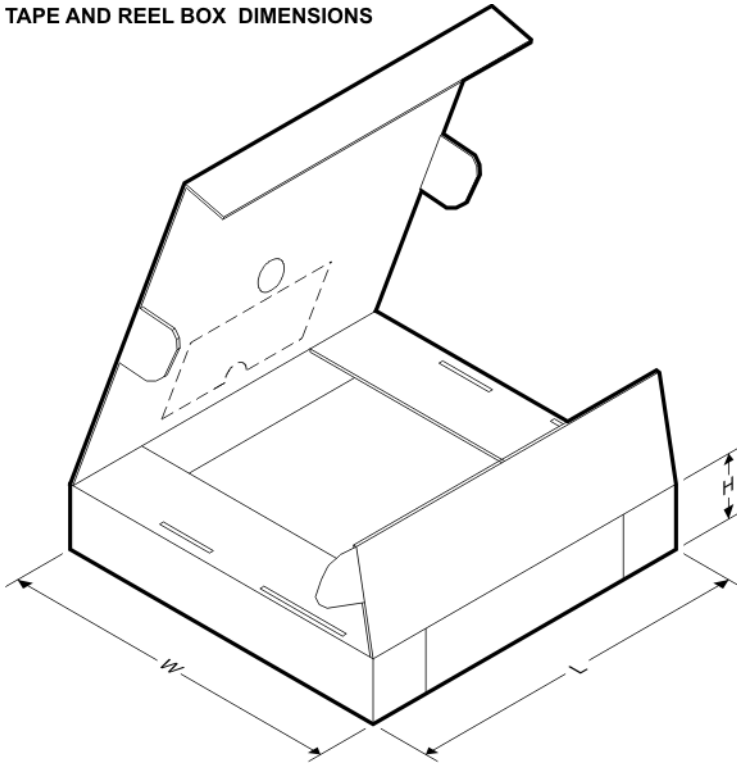
Device	Package Type	Package Drawing	Pins	SPQ	Reel Diameter (mm)	Reel Width W1 (mm)	A0 (mm)	B0 (mm)	K0 (mm)	P1 (mm)	W (mm)	Pin1 Quadrant
TRF3722IRGZR	VQFN	RGZ	48	2500	330.0	16.4	7.3	7.3	1.5	12.0	16.0	Q2
TRF3722IRGZT	VQFN	RGZ	48	250	180.0	16.4	7.3	7.3	1.5	12.0	16.0	Q2

TAPE AND REEL BOX DIMENSIONS

*All dimensions are nominal

Device	Package Type	Package Drawing	Pins	SPQ	Length (mm)	Width (mm)	Height (mm)
TRF3722IRGZR	VQFN	RGZ	48	2500	336.6	336.6	28.6
TRF3722IRGZT	VQFN	RGZ	48	250	213.0	191.0	55.0

RGZ (S-PVQFN-N48)

PLASTIC QUAD FLATPACK NO-LEAD

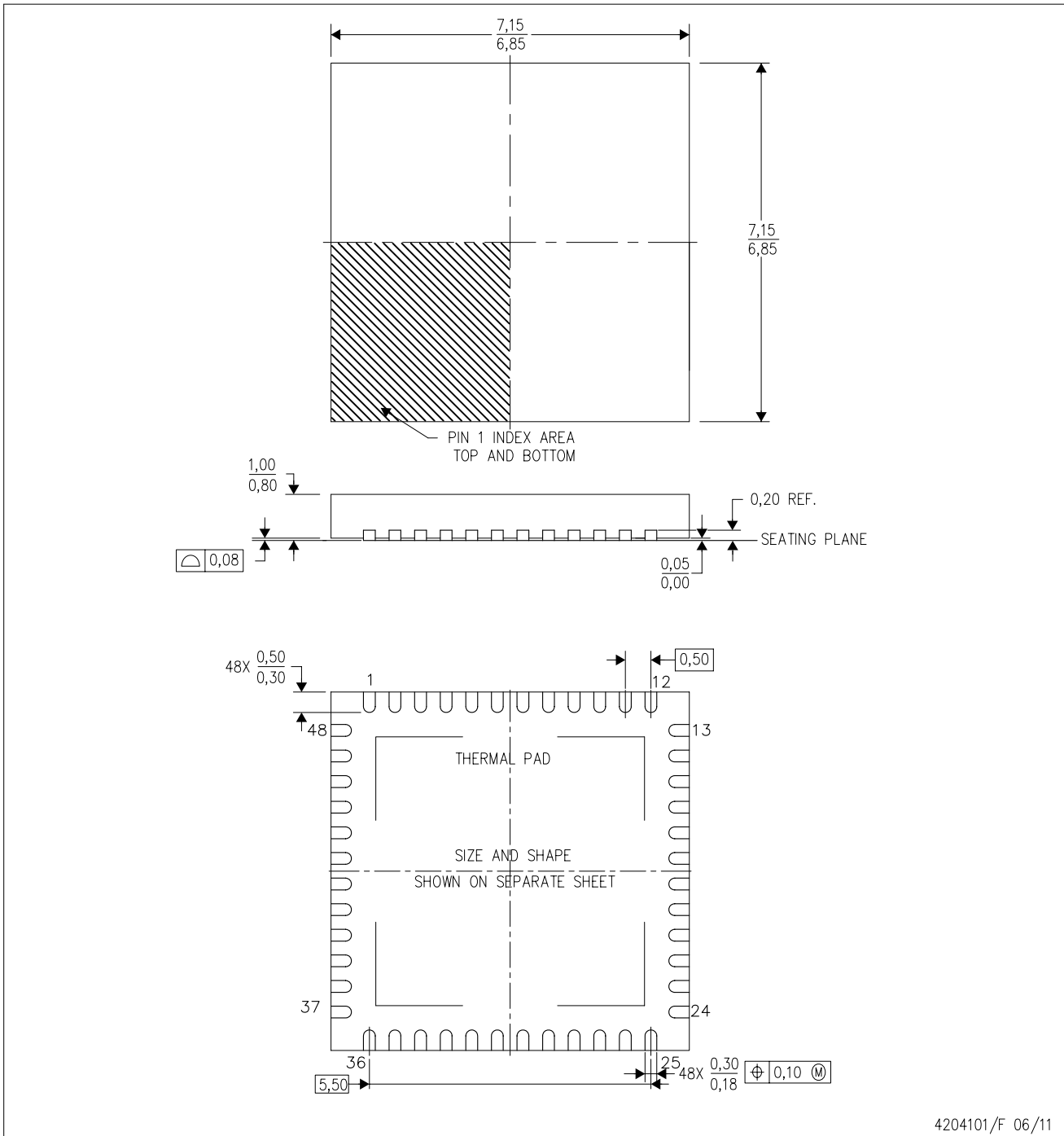

- NOTES:
- A. All linear dimensions are in millimeters. Dimensioning and tolerancing per ASME Y14.5M-1994.
 - B. This drawing is subject to change without notice.
 - C. Quad Flatpack, No-leads (QFN) package configuration.
 - D. The package thermal pad must be soldered to the board for thermal and mechanical performance.
 - E. See the additional figure in the Product Data Sheet for details regarding the exposed thermal pad features and dimensions.
 - F. Falls within JEDEC MO-220.

THERMAL INFORMATION

This package incorporates an exposed thermal pad that is designed to be attached directly to an external heatsink. The thermal pad must be soldered directly to the printed circuit board (PCB). After soldering, the PCB can be used as a heatsink. In addition, through the use of thermal vias, the thermal pad can be attached directly to the appropriate copper plane shown in the electrical schematic for the device, or alternatively, can be attached to a special heatsink structure designed into the PCB. This design optimizes the heat transfer from the integrated circuit (IC).

For information on the Quad Flatpack No-Lead (QFN) package and its advantages, refer to Application Report, QFN/SON PCB Attachment, Texas Instruments Literature No. SLUA271. This document is available at www.ti.com.

The exposed thermal pad dimensions for this package are shown in the following illustration.

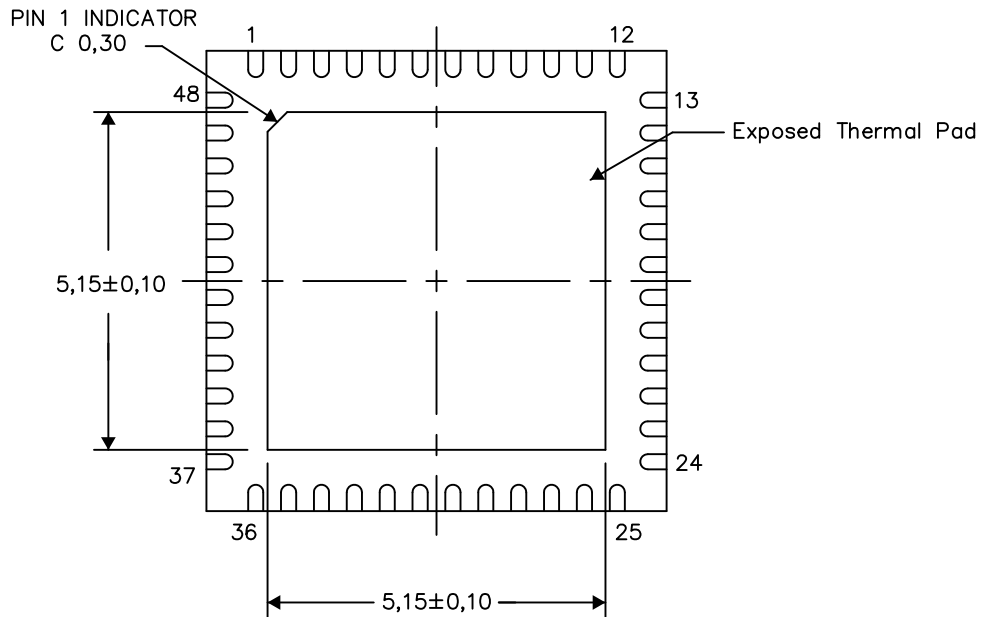

Bottom View

Exposed Thermal Pad Dimensions

4206354-2/Z 03/15

NOTE: All linear dimensions are in millimeters

IMPORTANT NOTICE

Texas Instruments Incorporated and its subsidiaries (TI) reserve the right to make corrections, enhancements, improvements and other changes to its semiconductor products and services per JESD46, latest issue, and to discontinue any product or service per JESD48, latest issue. Buyers should obtain the latest relevant information before placing orders and should verify that such information is current and complete. All semiconductor products (also referred to herein as "components") are sold subject to TI's terms and conditions of sale supplied at the time of order acknowledgment.

TI warrants performance of its components to the specifications applicable at the time of sale, in accordance with the warranty in TI's terms and conditions of sale of semiconductor products. Testing and other quality control techniques are used to the extent TI deems necessary to support this warranty. Except where mandated by applicable law, testing of all parameters of each component is not necessarily performed.

TI assumes no liability for applications assistance or the design of Buyers' products. Buyers are responsible for their products and applications using TI components. To minimize the risks associated with Buyers' products and applications, Buyers should provide adequate design and operating safeguards.

TI does not warrant or represent that any license, either express or implied, is granted under any patent right, copyright, mask work right, or other intellectual property right relating to any combination, machine, or process in which TI components or services are used. Information published by TI regarding third-party products or services does not constitute a license to use such products or services or a warranty or endorsement thereof. Use of such information may require a license from a third party under the patents or other intellectual property of the third party, or a license from TI under the patents or other intellectual property of TI.

Reproduction of significant portions of TI information in TI data books or data sheets is permissible only if reproduction is without alteration and is accompanied by all associated warranties, conditions, limitations, and notices. TI is not responsible or liable for such altered documentation. Information of third parties may be subject to additional restrictions.

Resale of TI components or services with statements different from or beyond the parameters stated by TI for that component or service voids all express and any implied warranties for the associated TI component or service and is an unfair and deceptive business practice. TI is not responsible or liable for any such statements.

Buyer acknowledges and agrees that it is solely responsible for compliance with all legal, regulatory and safety-related requirements concerning its products, and any use of TI components in its applications, notwithstanding any applications-related information or support that may be provided by TI. Buyer represents and agrees that it has all the necessary expertise to create and implement safeguards which anticipate dangerous consequences of failures, monitor failures and their consequences, lessen the likelihood of failures that might cause harm and take appropriate remedial actions. Buyer will fully indemnify TI and its representatives against any damages arising out of the use of any TI components in safety-critical applications.

In some cases, TI components may be promoted specifically to facilitate safety-related applications. With such components, TI's goal is to help enable customers to design and create their own end-product solutions that meet applicable functional safety standards and requirements. Nonetheless, such components are subject to these terms.

No TI components are authorized for use in FDA Class III (or similar life-critical medical equipment) unless authorized officers of the parties have executed a special agreement specifically governing such use.

Only those TI components which TI has specifically designated as military grade or "enhanced plastic" are designed and intended for use in military/aerospace applications or environments. Buyer acknowledges and agrees that any military or aerospace use of TI components which have **not** been so designated is solely at the Buyer's risk, and that Buyer is solely responsible for compliance with all legal and regulatory requirements in connection with such use.

TI has specifically designated certain components as meeting ISO/TS16949 requirements, mainly for automotive use. In any case of use of non-designated products, TI will not be responsible for any failure to meet ISO/TS16949.

Products

Audio	www.ti.com/audio
Amplifiers	amplifier.ti.com
Data Converters	dataconverter.ti.com
DLP® Products	www.dlp.com
DSP	dsp.ti.com
Clocks and Timers	www.ti.com/clocks
Interface	interface.ti.com
Logic	logic.ti.com
Power Mgmt	power.ti.com
Microcontrollers	microcontroller.ti.com
RFID	www.ti-rfid.com
OMAP Applications Processors	www.ti.com/omap
Wireless Connectivity	www.ti.com/wirelessconnectivity

Applications

Automotive and Transportation	www.ti.com/automotive
Communications and Telecom	www.ti.com/communications
Computers and Peripherals	www.ti.com/computers
Consumer Electronics	www.ti.com/consumer-apps
Energy and Lighting	www.ti.com/energy
Industrial	www.ti.com/industrial
Medical	www.ti.com/medical
Security	www.ti.com/security
Space, Avionics and Defense	www.ti.com/space-avionics-defense
Video and Imaging	www.ti.com/video

TI E2E Community

e2e.ti.com