

## IR Receiver Modules for Remote Control Systems

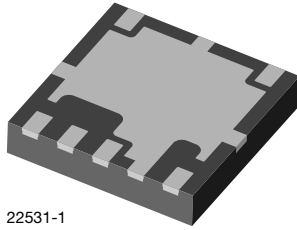

22531-1

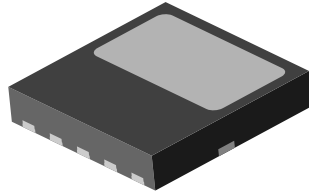

### ORDERING CODE

#### Taping:

TSOP57...TT1 - top view taped

TSOP57...TT2 - top view taped

### FEATURES

- Improved immunity against HF and RF noise
- Height of 0.8 mm
- $\pm 75^\circ$  half angle sensitivity
- Low supply current
- Photo detectors and preamplifier in one package
- Internal filter for PCM frequency
- Supply voltage: 2.5 V to 5.5 V, typically even 2.0 V to 5.5 V is possible
- Improved immunity against optical noise
- Insensitive to supply voltage ripple and noise
- Material categorization: for definitions of compliance please see [www.vishay.com/doc?99912](http://www.vishay.com/doc?99912)



### DESCRIPTION

The TSOP57... series are miniaturized SMD IR receiver modules for infrared remote control systems. A PIN diode and a preamplifier are assembled on a PCB, the epoxy package contains an IR filter.

The demodulated output signal can be directly connected to a microprocessor for decoding.

The TSOP574.. series devices are optimized to suppress almost all spurious pulses from Wi-Fi and CFL sources. They may suppress some data signals if continuously transmitted.

The TSOP572.. series devices are provided primarily for compatibility with old AGC2 designs. New designs should prefer the TSOP574.. series containing the newer AGC4.

These components have not been qualified according to automotive specifications.

| PARTS TABLE              |        |   |  |
|--------------------------|--------|---|--|
| AGC                      |        | LEGACY, FOR<br>LONG BURST REMOTE CONTROLS (AGC2)  | RECOMMENDED FOR<br>LONG BURST CODES (AGC4) |
| Carrier frequency        | 36 kHz | TSOP57236   | TSOP57436 <sup>(1)(2)(3)</sup>             |
|                          | 38 kHz | TSOP57238   | TSOP57438 <sup>(4)(5)</sup>                |
|                          | 40 kHz | TSOP57240   | TSOP57440                                  |
|                          | 56 kHz | TSOP57256   | TSOP57456 <sup>(6)(7)</sup>                |
| Package                  |        | Belobog   |  |
| Pinning                  |        | 1 = OUT, 2, 3, 6, 7, 8 = GND, 4, 5 = V <sub>S</sub>   |  |
| Dimensions (mm)          |        | 3.95 W x 3.95 H x 0.8 D   |  |
| Mounting                 |        | SMD   |  |
| Application              |        | Remote control  |  |
| Best remote control code |        | <sup>(1)</sup> RC-5 <sup>(2)</sup> RC-6 <sup>(3)</sup> Panasonic <sup>(4)</sup> NEC <sup>(5)</sup> Sharp <sup>(6)</sup> r-step <sup>(7)</sup> Thomson RCA |  |

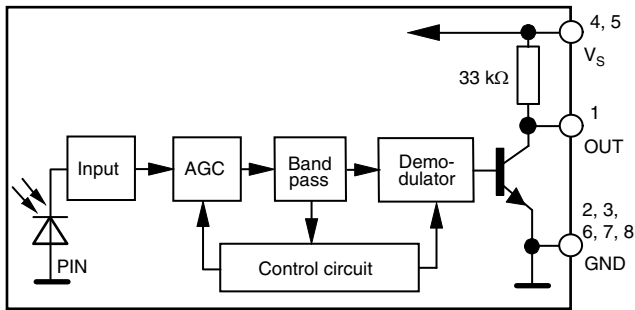
**BLOCK DIAGRAM**

20445-6

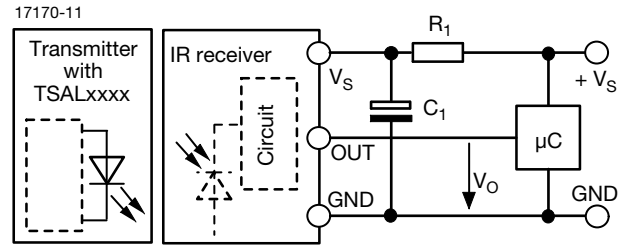
**APPLICATION CIRCUIT**

 $R_1$  and  $C_1$  recommended to reduce supply ripple for  $V_S < 2.8\text{ V}$ 
**ABSOLUTE MAXIMUM RATINGS**

| PARAMETER                   | TEST CONDITION              | SYMBOL    | VALUE                 | UNIT |
|-----------------------------|-----------------------------|-----------|-----------------------|------|
| Supply voltage              |                             | $V_S$     | -0.3 to +6            | V    |
| Supply current              |                             | $I_S$     | 5                     | mA   |
| Output voltage              |                             | $V_O$     | -0.3 to $(V_S + 0.3)$ | V    |
| Output current              |                             | $I_O$     | 5                     | mA   |
| Junction temperature        |                             | $T_j$     | 100                   | °C   |
| Storage temperature range   |                             | $T_{stg}$ | -25 to +85            | °C   |
| Operating temperature range |                             | $T_{amb}$ | -25 to +85            | °C   |
| Power consumption           | $T_{amb} \leq 85\text{ °C}$ | $P_{tot}$ | 10                    | mW   |

**Note**

- Stresses beyond those listed under “Absolute Maximum Ratings” may cause permanent damage to the device. This is a stress rating only and functional operation of the device at these or any other conditions beyond those indicated in the operational sections of this specification is not implied. Exposure to absolute maximum rating conditions for extended periods may affect the device reliability.

**ELECTRICAL AND OPTICAL CHARACTERISTICS** ( $T_{amb} = 25\text{ °C}$ , unless otherwise specified)

| PARAMETER             | TEST CONDITION   | SYMBOL            | MIN. | TYP.     | MAX. | UNIT            |
|-----------------------|--|-------------------|------|----------|------|-----------------|
| Supply voltage        |  | $V_S$             | 2.5  | -        | 5.5  | V               |
| Supply current        | $V_S = 5\text{ V}$ , $E_v = 0$   | $I_{SD}$          | 0.55 | 0.7      | 0.9  | mA              |
|                       | $E_v = 40\text{ klx}$ , sunlight   | $I_{SH}$          | -    | 0.8      | -    | mA              |
| Transmission distance | $E_v = 0$ ,<br>IR diode TSAL6200,<br>$I_F = 250\text{ mA}$ ,<br>test signal see Fig. 1           | $d$               | -    | 40       | -    | m               |
| Output voltage low    | $I_{OSL} = 0.5\text{ mA}$ , $E_e = 0.7\text{ mW/m}^2$ ,<br>test signal see Fig. 1                | $V_{OSL}$         | -    | -        | 100  | mV              |
| Minimum irradiance    | Pulse width tolerance:<br>$t_{pi} - 5/f_o < t_{po} < t_{pi} + 6/f_o$ ,<br>test signal see Fig. 1 | $E_e\text{ min.}$ | -    | 0.2      | 0.4  | $\text{mW/m}^2$ |
| Maximum irradiance    | $t_{pi} - 5/f_o < t_{po} < t_{pi} + 6/f_o$ ,<br>test signal see Fig. 1                           | $E_e\text{ max.}$ | 50   | -        | -    | $\text{W/m}^2$  |
| Directivity           | Angle of half transmission distance  | $\phi_{1/2}$      | -    | $\pm 75$ | -    | deg             |

## TYPICAL CHARACTERISTICS (T<sub>amb</sub> = 25 °C, unless otherwise specified)

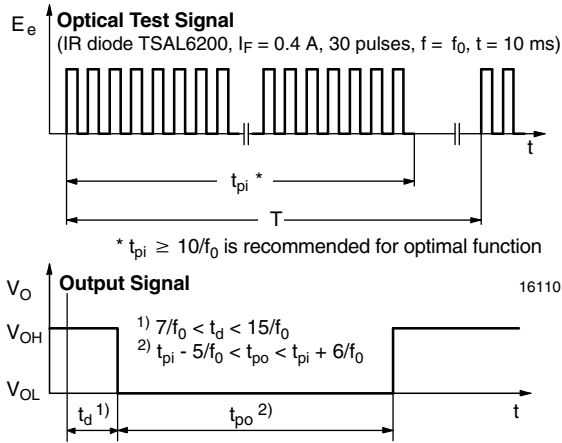

Fig. 1 - Output Active Low

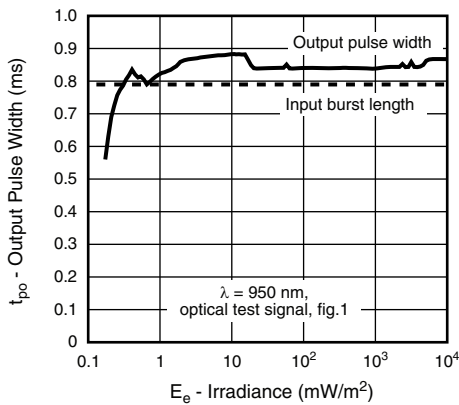

Fig. 2 - Pulse Length and Sensitivity in Dark Ambient

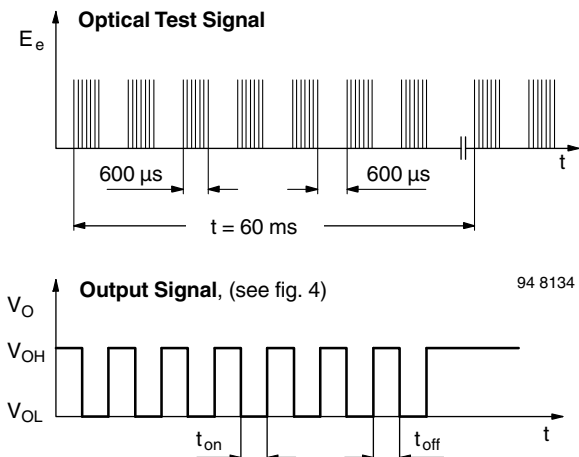

Fig. 3 - Output Function

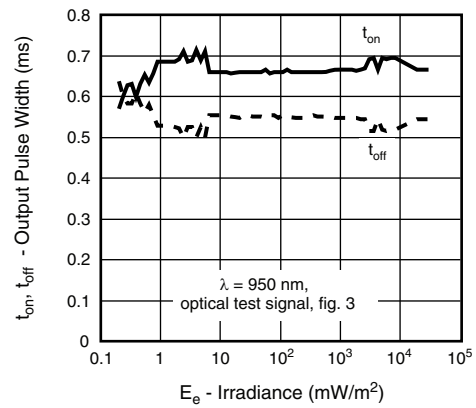

Fig. 4 - Output Pulse Diagram

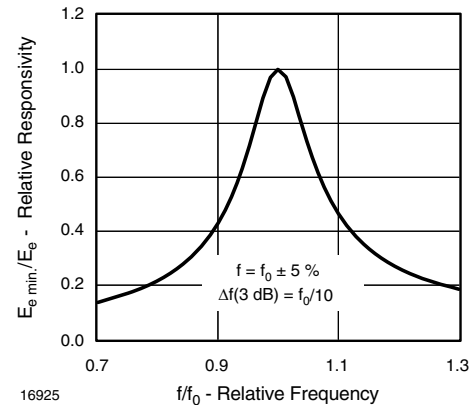

Fig. 5 - Frequency Dependence of Responsivity

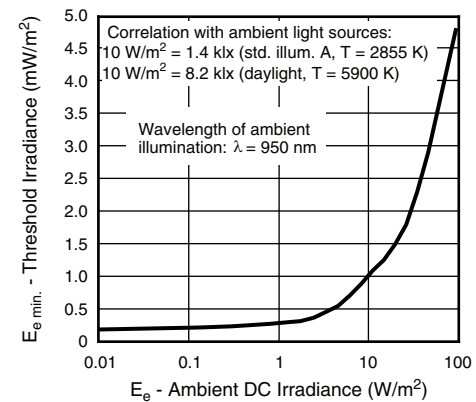

Fig. 6 - Sensitivity in Bright Ambient

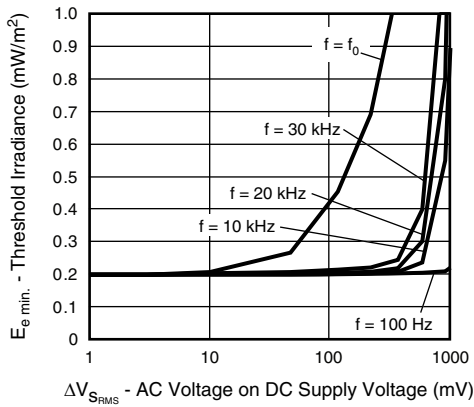

Fig. 7 - Sensitivity vs. Supply Voltage Disturbances

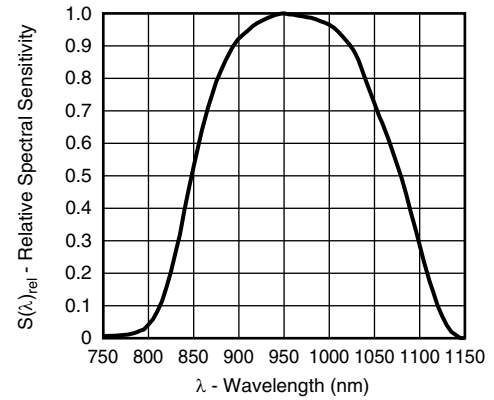

Fig. 10 - Relative Spectral Sensitivity vs. Wavelength

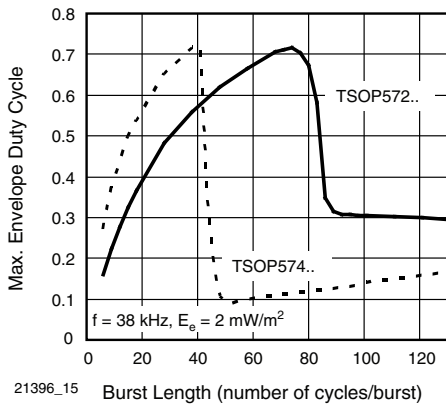

Fig. 8 - Max. Envelope Duty Cycle vs. Burst Length

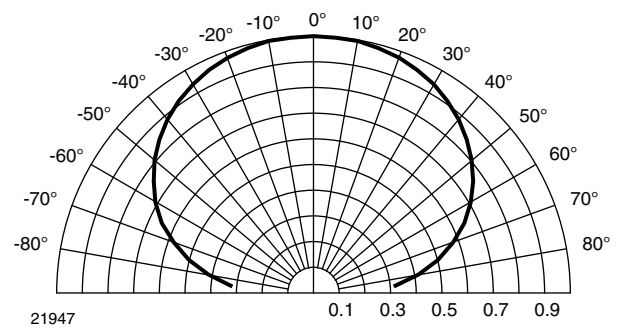

Fig. 11 - Horizontal Directivity

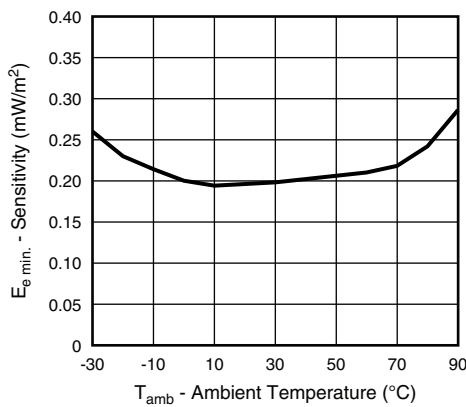

Fig. 9 - Sensitivity vs. Ambient Temperature

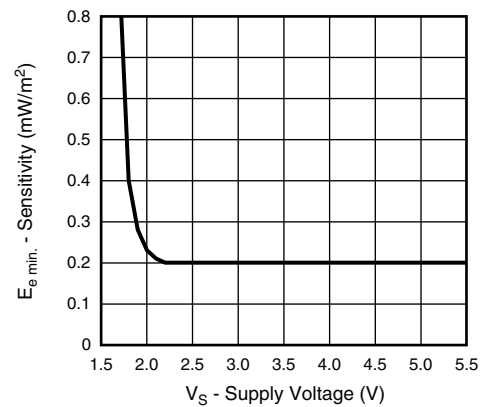

Fig. 12 - Sensitivity vs. Supply Voltage

**SUITABLE DATA FORMAT**

The TSOP572.., TSOP574.. series is designed to suppress spurious output pulses due to noise or disturbance signals. The devices can distinguish data signals from noise due to differences in frequency, burst length, and envelope duty cycle. The data signal should be close to the device's band-pass center frequency (e.g. 38 kHz) and fulfill the conditions in the table below.

When a data signal is applied to the TSOP572.., TSOP574.. in the presence of a disturbance, the sensitivity of the receiver is automatically reduced by the AGC to insure that no spurious pulses are present at the receiver's output. Some examples which are suppressed are:

- DC light (e.g. from tungsten bulbs sunlight)
- Continuous signals at any frequency
- Strongly or weakly modulated patterns from fluorescent lamps with electronic ballasts (see Fig. 13 or Fig. 14)
- 2.4 GHz and 5 GHz Wi-Fi

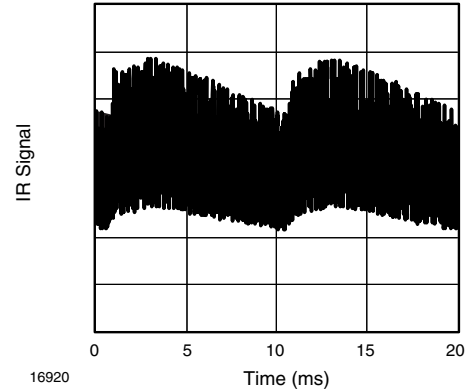

Fig. 13 - IR Signal from Fluorescent Lamp with Low Modulation

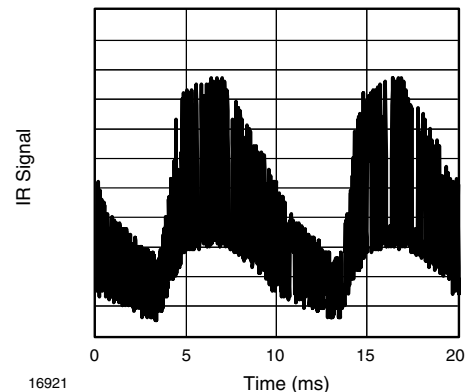

Fig. 14 - IR Signal from Fluorescent Lamp with High Modulation

|  | <b>TSOP572..</b>  | <b>TSOP574..</b>  |
|--|---|---|
| Minimum burst length   | 10 cycles/burst   | 10 cycles/burst   |
| After each burst of length a minimum gap time is required of               | 10 to 70 cycles<br>≥ 10 cycles  | 10 to 42 cycles<br>≥ 10 cycles  |
| For bursts greater than a minimum gap time in the data stream is needed of | 70 cycles<br>> 4 x burst length   | 42 cycles<br>> 10 x burst length  |
| Maximum number of continuous short bursts/second                           | 800   | 1300  |
| NEC code   | Yes   | Preferred   |
| RC5/RC6 code   | Yes   | Preferred   |
| Thomson 56 kHz code  | Yes   | Preferred   |
| Suppression of interference from fluorescent lamps                         | Mild disturbance patterns are suppressed (example: signal pattern of Fig. 13) | Complex and critical disturbance patterns are suppressed (example: signal pattern of Fig. 14 or highly dimmed LCDs) |

**Note**

- For data formats with short bursts please see the datasheet for TSOP573..



## PACKAGE DIMENSIONS in millimeters

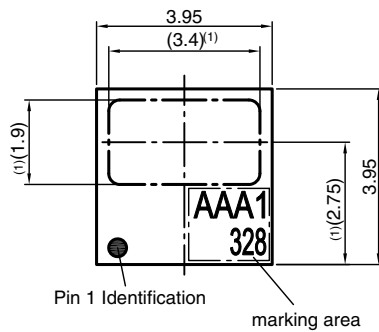
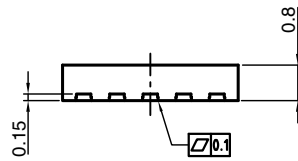
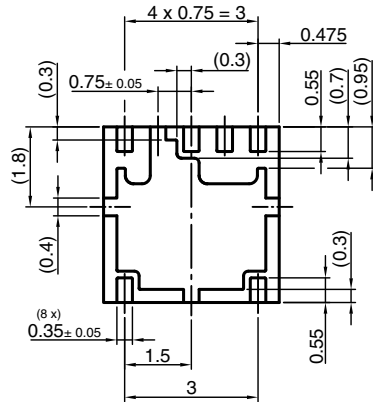

Drawing-No.: 6.550-5315.01-4  
Issue: 2; 12.02.14

Not indicated tolerances ± 0.1

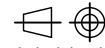

technical drawings  
according to DIN  
specifications

Pinning from topview

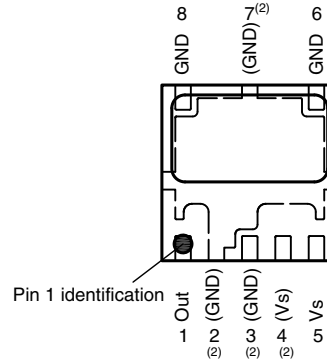

Proposed pad layout from  
component side  
(dim. for reference only)

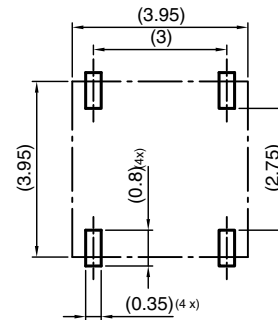

### Notes

- (1) Optically effective area
- (2) Pins connected internally. It is not necessary to connect externally.



ASSEMBLY INSTRUCTIONS

Reflow Soldering

- Reflow soldering must be done within 168 h while stored under a max. temperature of 30 °C, 60 % RH after opening the dry pack envelope
- Set the furnace temperatures for pre-heating and heating in accordance with the reflow temperature profile as shown in the diagram. Exercise extreme care to keep the maximum temperature below 260 °C. The temperature shown in the profile means the temperature at the device surface. Since there is a temperature difference between the component and the circuit board, it should be verified that the temperature of the device is accurately being measured
- Handling after reflow should be done only after the work surface has been cooled off

Manual Soldering

- Use a soldering iron of 25 W or less. Adjust the temperature of the soldering iron below 300 °C
- Finish soldering within 3 s
- Handle products only after the temperature has cooled off

VISHAY LEAD (Pb)-FREE REFLOW SOLDER PROFILE

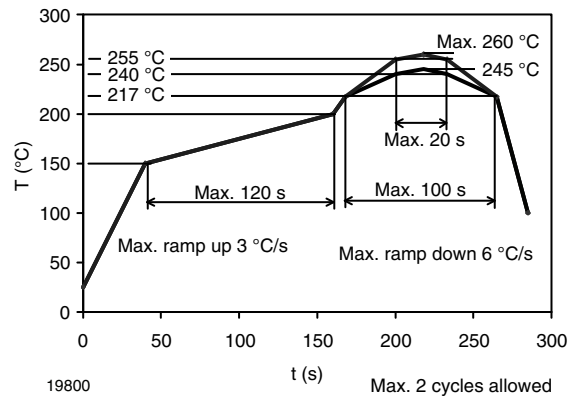

| ORDERING INFORMATION |               |                       |                             |
|----------------------|---------------|-----------------------|-----------------------------|
| ORDERING CODE        | PACKAGING     | VOLUME <sup>(1)</sup> | REMARKS                     |
| TSOP57..TT1          | Tape and reel | MOQ: 1800 pcs         | 3.95 mm x 3.95 mm x 0.75 mm |
| TSOP57..TT2          |               | MOQ: 7000 pcs         |                             |

Note

<sup>(1)</sup> MOQ: minimum order quantity



## TAPING VERSION TSOP57... DIMENSIONS in millimeters

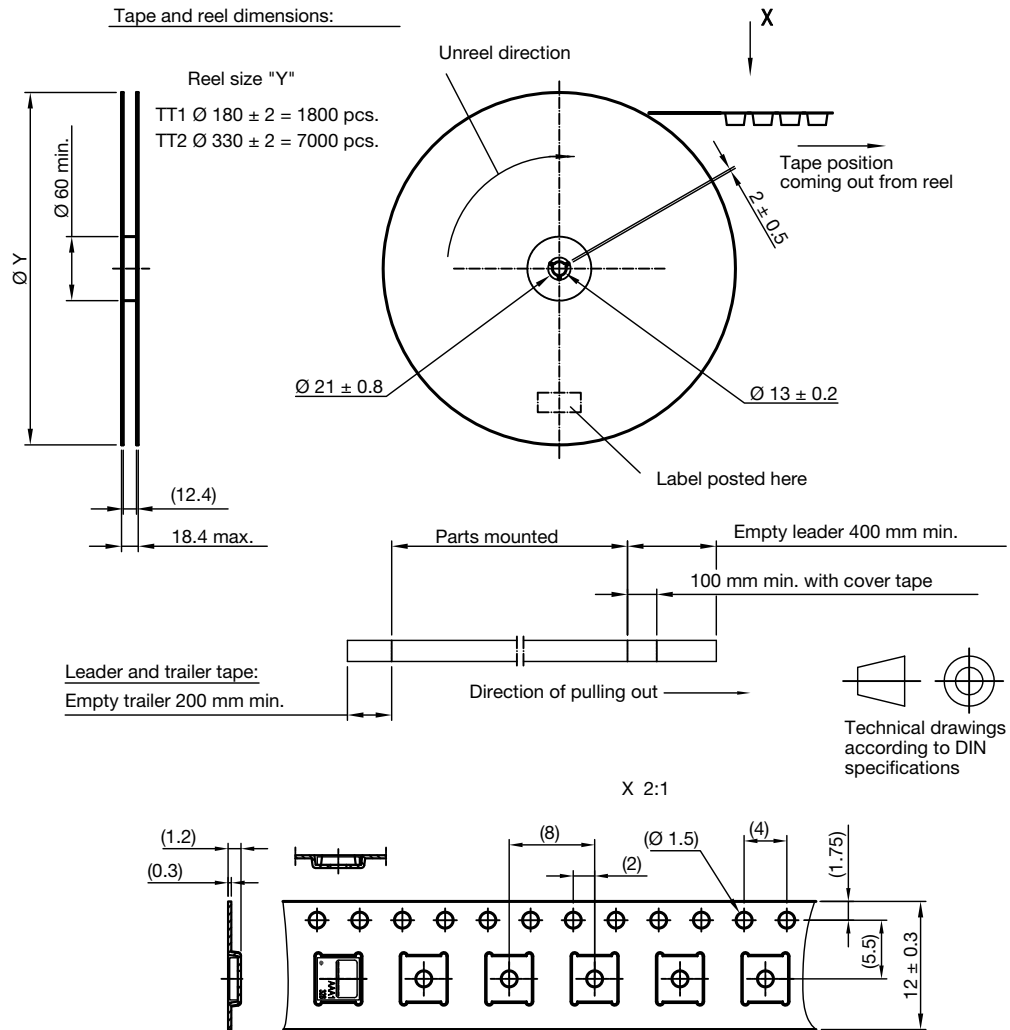

Drawing-No.: 9.700-5347.01-4  
Issue: 1; 14.11.11

Not indicated tolerances  $\pm 0.1$



**LABEL**
**Standard bar code labels for finished goods**

The standard bar code labels are product labels and used for identification of goods. The finished goods are packed in final packing area. The standard packing units are labeled

with standard bar code labels before transported as finished goods to warehouses. The labels are on each packing unit and contain Vishay Semiconductor GmbH specific data.

| <b>VISHAY SEMICONDUCTOR GmbH STANDARD BAR CODE PRODUCT LABEL (finished goods)</b> |                     |               |
|---|---------------------|---------------|
| <b>PLAIN WRITING</b>  | <b>ABBREVIATION</b> | <b>LENGTH</b> |
| Item-description  | -                   | 18            |
| Item-number   | INO                 | 8             |
| Selection-code  | SEL                 | 3             |
| LOT-/serial-number  | BATCH               | 10            |
| Data-code   | COD                 | 3 (YWW)       |
| Plant-code  | PTC                 | 2             |
| Quantity  | QTY                 | 8             |
| Accepted by   | ACC                 | -             |
| Packed by   | PCK                 | -             |
| Mixed code indicator  | MIXED CODE          | -             |
| Origin  | xxxxxxx+            | Company logo  |
| <b>Long bar code top</b>  | <b>Type</b>         | <b>Length</b> |
| Item-number   | N                   | 8             |
| Plant-code  | N                   | 2             |
| Sequence-number   | X                   | 3             |
| Quantity  | N                   | 8             |
| Total length  | -                   | 21            |
| <b>Short bar code bottom</b>  | <b>Type</b>         | <b>Length</b> |
| Selection-code  | X                   | 3             |
| Data-code   | N                   | 3             |
| Batch-number  | X                   | 10            |
| Filter  | -                   | 1             |
| Total length  | -                   | 17            |

**DRY PACKING**

The reel is packed in an anti-humidity bag to protect the devices from absorbing moisture during transportation and storage.

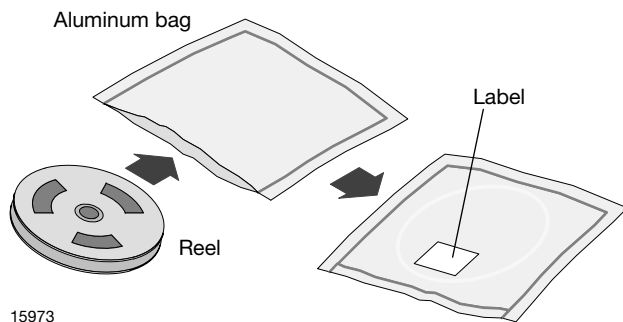
**FINAL PACKING**

The sealed reel is packed into a cardboard box. A secondary cardboard box is used for shipping purposes.

**RECOMMENDED METHOD OF STORAGE**

Dry box storage is recommended as soon as the aluminum bag has been opened to prevent moisture absorption. The following conditions should be observed, if dry boxes are not available:

- Storage temperature 10 °C to 30 °C
- Storage humidity ≤ 60 % RH max.

After more than 168 h under these conditions moisture content will be too high for reflow soldering.

In case of moisture absorption, the devices will recover to the former condition by drying under the following condition: 192 h at 40 °C + 5 °C / - 0 °C and < 5 % RH (dry air / nitrogen) or

96 h at 60 °C + 5 °C and < 5 % RH for all device containers or

24 h at 125 °C + 5 °C not suitable for reel or tubes.

An EIA JEDEC® standard J-STD-020 level 3 label is included on all dry bags.





**Caution**  
This bag contains  
**MOISTURE-SENSITIVE DEVICES**

**LEVEL**  
3

If blank, see adjacent bar code label

1. Calculated shelf life in sealed bag: 12 months at <40°C and <90% relative humidity (RH)
2. Peak package body temperature: 260 °C  
If blank, see adjacent bar code label
3. After bag is opened, devices that will be subjected to reflow solder or other high temperature process must be
  - a) Mounted within: 168 hours of factory conditions  
If blank, see adjacent bar code label
  - <30°C/60% RH, or
  - b) Stored per J-STD-033
4. Devices require bake, before mounting, if:
  - a) Humidity Indicator Card reads > 10% for level 2a - 5a devices or >60% for level 2 devices when read at 23±5°C
  - b) 3a or 3b are not met
5. If baking is required, refer to IPC/JEDEC J-STD-033 for bake procedure

Bag Seal Date: \_\_\_\_\_  
If blank, see adjacent bar code label

Note: Level and body temperature defined by IPC/JEDEC J-STD-020

22650

EIA JEDEC standard J-STD-020 level 3 label is included on all dry bags

### ESD PRECAUTION

Proper storage and handling procedures should be followed to prevent ESD damage to the devices especially when they are removed from the antistatic shielding bag. Electrostatic sensitive devices warning labels are on the packaging.

### VISHAY SEMICONDUCTORS STANDARD BAR CODE LABELS

The Vishay Semiconductors standard bar code labels are printed at final packing areas. The labels are on each packing unit and contain Vishay Semiconductors specific data.

### BAR CODE PRODUCT LABEL (example)

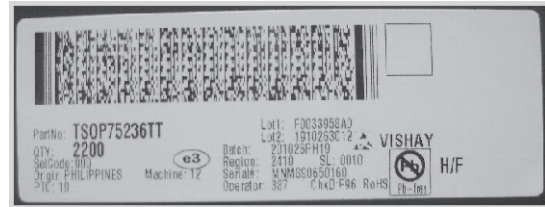

22178



## **Disclaimer**

ALL PRODUCT, PRODUCT SPECIFICATIONS AND DATA ARE SUBJECT TO CHANGE WITHOUT NOTICE TO IMPROVE RELIABILITY, FUNCTION OR DESIGN OR OTHERWISE.

Vishay Intertechnology, Inc., its affiliates, agents, and employees, and all persons acting on its or their behalf (collectively, "Vishay"), disclaim any and all liability for any errors, inaccuracies or incompleteness contained in any datasheet or in any other disclosure relating to any product.

Vishay makes no warranty, representation or guarantee regarding the suitability of the products for any particular purpose or the continuing production of any product. To the maximum extent permitted by applicable law, Vishay disclaims (i) any and all liability arising out of the application or use of any product, (ii) any and all liability, including without limitation special, consequential or incidental damages, and (iii) any and all implied warranties, including warranties of fitness for particular purpose, non-infringement and merchantability.

Statements regarding the suitability of products for certain types of applications are based on Vishay's knowledge of typical requirements that are often placed on Vishay products in generic applications. Such statements are not binding statements about the suitability of products for a particular application. It is the customer's responsibility to validate that a particular product with the properties described in the product specification is suitable for use in a particular application. Parameters provided in datasheets and / or specifications may vary in different applications and performance may vary over time. All operating parameters, including typical parameters, must be validated for each customer application by the customer's technical experts. Product specifications do not expand or otherwise modify Vishay's terms and conditions of purchase, including but not limited to the warranty expressed therein.

Except as expressly indicated in writing, Vishay products are not designed for use in medical, life-saving, or life-sustaining applications or for any other application in which the failure of the Vishay product could result in personal injury or death. Customers using or selling Vishay products not expressly indicated for use in such applications do so at their own risk. Please contact authorized Vishay personnel to obtain written terms and conditions regarding products designed for such applications.

No license, express or implied, by estoppel or otherwise, to any intellectual property rights is granted by this document or by any conduct of Vishay. Product names and markings noted herein may be trademarks of their respective owners.