

**Proven  
Reliability**

# Q SERIES

ISOLATED, PROPORTIONAL DC TO HV DC CONVERTERS

100V to 10,000V @ 0.5 and 1.25 Watts

**NOW  
UL RECOGNIZED**

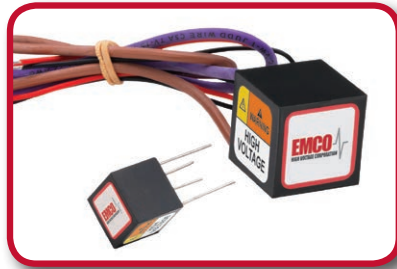

## PRODUCT DESCRIPTION

The Q Series is a broad line of ultra-miniature, high reliability DC to HV DC converters supplying up to 5,000 volts in only 0.125 cubic inches and up to 10,000 volts in only 0.614 cubic inches. These component-sized converters are ideal for applications requiring minimal size and weight. The output is directly proportional to the input voltage and is linear from <0.7V input to maximum input voltage, allowing for an adjustable output voltage.

## OPTIONS

- 0.5 Watt and 1.25 Watt versions available (1.25W up to 2KV)
- Dual Output (Center Tap) option available (up to Q09 / QH09)
- External Copper Shield (S suffix)
- Control Pin Option available (up to Q50 / QH20) (C suffix)
- Extended operating temperature (0.5W - Q models) (T suffix)
- Ordering Information (see Page 13)
- Alternate Input / Output Voltages (consult factory)
- Alternate Pin Pattern, see VA units (Page 10)
- Reduced Input Power (consult factory)

## APPLICATIONS

- Avalanche Photodiodes
- Photomultiplier Tubes
- Light Sources
- Piezo Devices
- Sustaining Ion Pumps
- Electrophoresis
- Printers
- Igniters
- Capacitor Charging

## FEATURES

- Ultra-Miniature Case Size
- Proven Reliability
- No External Components Required
- Low Ripple and EMI/RFI
- Proportional Input/Output
- Input/Output Isolation
- Low Leakage Current <250nA
- Low input/output coupling capacitance, <50 pF typical
- MTBF: >3 million hrs. per Bellcore TR 332
- Short circuit protection, 1 minute minimum
- Control Pin can be used for ON/OFF control
- RoHS Compliant
- UL Recognized

## PRODUCT OVERVIEW

OUTPUT VOLTAGE*2	Q MODELS 0.50 Watt	QH MODELS 1.25 Watt
100 VDC	Q01	QH01
150 VDC	Q015	QH015
200 VDC	Q02	QH02
250 VDC	Q025	QH025
300 VDC	Q03	QH03
350 VDC	Q035	QH035
400 VDC	Q04	QH04
450 VDC	Q045	QH045
500 VDC	Q05	QH05
600 VDC	Q06	QH06
700 VDC	Q07	QH07
800 VDC	Q08	QH08
900 VDC	Q09	QH09
1,000 VDC	Q10	QH10
1,200 VDC	Q12	QH12
1,500 VDC	Q15	QH15
2,000 VDC	Q20	QH20
2,500 VDC	Q25	
3,000 VDC	Q30	
4,000 VDC	Q40	
5,000 VDC	Q50	
6,000 VDC	Q60	
8,000 VDC	Q80	
10,000 VDC	Q101	

Complete List of Models on pages 2-5

ISO 9001:2008  
CERTIFIED

ISO 14001:2004  
CERTIFIED

RoHS  
COMPLIANT

C UL US  
E344664

CE

IPC  
Certified J-STD-001  
Application Specialist

ELECTRICAL SPECIFICATIONS<sup>3</sup> (100V - 900V)

OUTPUT VOLTAGE*2	Q MODELS - 0.50 Watt			QH MODELS - 1.25 Watt		
	MODEL*6	MAXIMUM OUTPUT CURRENT*1	RIPPLE P-P	MODEL*6	MAXIMUM OUTPUT CURRENT*1	RIPPLE P-P
REVERSIBLE: 0 TO (+) OR (-) Vout						
0 to 100VDC	Q01	5.000 mA	<1.000 %	QH01	12.500 mA	<2.500 %
0 to 150VDC	Q015	3.333 mA	<0.500 %	QH015	8.333 mA	<1.125 %
0 to 200VDC	Q02	2.500 mA	<0.250 %	QH02	6.250 mA	<1.125 %
0 to 250VDC	Q025	2.000 mA	<0.250 %	QH025	5.000 mA	<1.125 %
0 to 300VDC	Q03	1.667 mA	<0.250 %	QH03	4.167 mA	<1.125 %
0 to 350VDC	Q035	1.429 mA	<0.250 %	QH035	3.571 mA	<1.125 %
0 to 400VDC	Q04	1.250 mA	<0.100 %	QH04	3.125 mA	<0.500 %
0 to 450VDC	Q045	1.111 mA	<0.150 %	QH045	2.778 mA	<0.625 %
0 to 500VDC	Q05	1.000 mA	<0.150 %	QH05	2.500 mA	<0.625 %
0 to 600VDC	Q06	0.833 mA	<0.100 %	QH06	2.083 mA	<0.500 %
0 to 700VDC	Q07	0.714 mA	<0.250 %	QH07	1.786 mA	<0.625 %
0 to 800VDC	Q08	0.625 mA	<0.300 %	QH08	1.563 mA	<1.0 %
0 to 900VDC	Q09	0.556 mA	<0.250 %	QH09	1.389 mA	<1.0 %

PARAMETER	VALUE
INPUT VOLTAGE	0 to 5, 12, 15 or 24 VOLTS
TYPICAL TURN-ON VOLTAGE	<0.7 VOLTS
ISOLATION	< +/- 500 VDC BIAS ON OUTPUT RETURN (PIN4)
OUTPUT VOLTAGE TOLERANCE	+10%, -10% (AT 100% OUTPUT, FULL LOAD)
FREQUENCY	75-500KHZ (TYPICAL)
CONTROL PIN	0 to VIN (SEE PAGE 12 FOR DETAILS)
STORAGE TEMPERATURE	-55 to +105°C
STANDARD OPERATING TEMPERATURE	-25 to +70°C <sup>4</sup> (CASE)
EXTENDED OPERATING TEMPERATURE	-55 to +75°C <sup>4</sup> (CASE) [Q models / 0.5W]

	INPUT CURRENT			
	Q MODELS - 0.50 Watt		QH MODELS - 1.250 Watt	
VIN	NO-LOAD	FULL-LOAD	NO-LOAD	FULL-LOAD
5 VDC	<100 mA	<250 mA	<250 mA	<550 mA
12 VDC	<40 mA	<100 mA	<100 mA	<250 mA
15 VDC	<32 mA	<80 mA	<80 mA	<200 mA
24 VDC	<20 mA	<50 mA	<50 mA	<125 mA

ELECTRICAL SPECIFICATIONS<sup>3</sup> (100V - 900V)

OUTPUT VOLTAGE*2	Q MODELS - 0.50 Watt			QH MODELS - 1.25 Watt		
	MODEL	MAXIMUM OUTPUT CURRENT*1	RIPPLE P-P	MODEL	MAXIMUM OUTPUT CURRENT*1	RIPPLE P-P*5
<b>DUAL OUTPUT (CENTER TAP): 0 TO (+) AND (-) Vout</b>						
0 to +/- 50 VDC	Q01CT	5.000 mA	<1.000 %	QH01CT	12.500 mA	<2.500 %
0 to +/- 75 VDC	Q015CT	3.333 mA	<0.500 %	QH015CT	8.333 mA	<1.125 %
0 to +/-100 VDC	Q02CT	2.500 mA	<0.250 %	QH02CT	6.250 mA	<1.125 %
0 to +/-125 VDC	Q025CT	2.000 mA	<0.250 %	QH025CT	5.000 mA	<1.125 %
0 to +/-150 VDC	Q03CT	1.667 mA	<0.250 %	QH03CT	4.167 mA	<1.125 %
0 to +/-175 VDC	Q035CT	1.429 mA	<0.250 %	QH035CT	3.571 mA	<1.125 %
0 to +/-200 VDC	Q04CT	1.250 mA	<0.100 %	QH04CT	3.125 mA	<0.500 %
0 to +/-225 VDC	Q045CT	1.111 mA	<0.150 %	QH045CT	2.778 mA	<0.625 %
0 to +/-250 VDC	Q05CT	1.000 mA	<0.150 %	QH05CT	2.500 mA	<0.625 %
0 to +/-300 VDC	Q06CT	0.833 mA	<0.100 %	QH06CT	2.083 mA	<0.500 %
0 to +/-350 VDC	Q07CT	0.714 mA	<0.250 %	QH07CT	1.786 mA	<0.625 %
0 to +/-400 VDC	Q08CT	0.625 mA	<0.300 %	QH08CT	1.563 mA	<1.0 %
0 to +/-450 VDC	Q09CT	0.556 mA	<0.250 %	QH09CT	1.389 mA	<1.0 %

PARAMETER	VALUE
INPUT VOLTAGE	0 to 5, 12, 15 or 24 VOLTS
TYPICAL TURN-ON VOLTAGE	<0.7 VOLTS
ISOLATION	< +/- 500 VDC BIAS ON OUTPUT RETURN (PIN4)
OUTPUT VOLTAGE TOLERANCE	+10%, -10% (AT 100% OUTPUT, FULL LOAD)
FREQUENCY	75-500KHZ (TYPICAL)
CONTROL PIN	0 to VIN (SEE PAGE 12 FOR DETAILS)
STORAGE TEMPERATURE	-55 to +105°C
STANDARD OPERATING TEMPERATURE	-25 to +70°C*4 (CASE)
EXTENDED OPERATING TEMPERATURE	-55 to +75°C*4 (CASE) [Q models / 0.5W]

	INPUT CURRENT			
	Q MODELS - 0.50 Watt		QH MODELS - 1.250 Watt	
VIN	NO-LOAD	FULL-LOAD	NO-LOAD	FULL-LOAD
5 VDC	<100 mA	<250 mA	<250 mA	<550 mA
12 VDC	<40 mA	<100 mA	<100 mA	<250 mA
15 VDC	<32 mA	<80 mA	<80 mA	<200 mA
24 VDC	<20 mA	<50 mA	<50 mA	<125 mA

ELECTRICAL SPECIFICATIONS<sup>\*3</sup> (1,000V - 2,000V)

	Q MODELS - 0.50 Watt			QH MODELS - 1.25 Watt		
OUTPUT VOLTAGE <sup>*2</sup>	MODEL	MAXIMUM OUTPUT CURRENT <sup>*1</sup>	RIPPLE P-P	MODEL	MAXIMUM OUTPUT CURRENT <sup>*1</sup>	RIPPLE P-P
<b>POSITIVE</b>						
0 to +1000 VDC	Q10	0.500 mA	<0.250 %	QH10	1.250 mA	<1.0%
0 to +1200 VDC	Q12	0.417 mA	<0.250 %	QH12	1.042 mA	<1.0%
0 to +1500 VDC	Q15	0.333 mA	<0.250 %	QH15	0.833 mA	<1.0%
0 to +2000 VDC	Q20	0.250 mA	<0.250 %	QH20	0.625 mA	<1.0%
<b>NEGATIVE</b>						
0 to -1000 VDC	Q10N	0.500 mA	<0.250 %	QH10N	1.250 mA	<1.0%
0 to -1200 VDC	Q12N	0.417 mA	<0.250 %	QH12N	1.042 mA	<1.0%
0 to -1500 VDC	Q15N	0.333 mA	<0.250 %	QH15N	0.833 mA	<1.0%
0 to -2000 VDC	Q20N	0.250 mA	<0.250 %	QH20N	0.625 mA	<1.0%

PARAMETER	VALUE
INPUT VOLTAGE	0 to 5, 12, 15 or 24 VOLTS
TYPICAL TURN-ON VOLTAGE	<0.7 VOLTS
ISOLATION	< +/- 500 VDC BIAS ON OUTPUT RETURN (PIN4)
OUTPUT VOLTAGE TOLERANCE	+10%, -10% (AT 100% OUTPUT, FULL LOAD)
FREQUENCY	75-500KHZ (TYPICAL)
CONTROL PIN	0 to VIN (SEE PAGE 12 FOR DETAILS)
STORAGE TEMPERATURE	-55 to +105°C
STANDARD OPERATING TEMPERATURE	-25 to +70°C <sup>*4</sup> (CASE)
EXTENDED OPERATING TEMPERATURE	-55 to +75°C <sup>*4</sup> (CASE) [Q models / 0.5W]

	INPUT CURRENT			
	Q MODELS - 0.50 Watt		QH MODELS - 1.25 Watt	
VIN	NO-LOAD	FULL-LOAD	NO-LOAD	FULL-LOAD
5 VDC	<100 mA	<250 mA	<250 mA	<550 mA
12 VDC	<40 mA	<100 mA	<100 mA	<250 mA
15 VDC	<32 mA	<80 mA	<80 mA	<200 mA
24 VDC	<20 mA	<50 mA	<50 mA	<125 mA

ELECTRICAL SPECIFICATIONS<sup>\*3</sup> (2,500V - 5,000V)

Q MODELS - 0.50 Watt			
OUTPUT VOLTAGE*2	MODEL	MAXIMUM OUTPUT CURRENT*1	RIPPLE P-P
<b>POSITIVE</b>			
0 to +2,500 VDC	Q25	0.200 mA	<0.500 %
0 to +3,000 VDC	Q30	0.167mA	<0.500 %
0 to +4,000 VDC	Q40	0.125 mA	<0.500 %
0 to +5,000 VDC	Q50	0.100 mA	<0.500 %
<b>NEGATIVE</b>			
0 to -2,500 VDC	Q25N	0.200 mA	<0.500 %
0 to -3,000 VDC	Q30N	0.167 mA	<0.500 %
0 to -4,000 VDC	Q40N	0.125 mA	<0.500 %
0 to -5,000 VDC	Q50N	0.100 mA	<0.500 %

PARAMETER	VALUE
INPUT VOLTAGE	0 to 5, 12, 15 or 24 VOLTS 0 TO 5V (FOR MODELS OVER 3KV)
TYPICAL TURN-ON VOLTAGE	<0.7 VOLTS
ISOLATION	< +/- 500 VDC BIAS ON OUTPUT RETURN (PIN4)
OUTPUT VOLTAGE TOLERANCE	+10%, -10% (AT 100% OUTPUT, FULL LOAD)
FREQUENCY	75-500KHZ (TYPICAL)
CONTROL PIN	0 to VIN (SEE PAGE 12 FOR DETAILS)
STORAGE TEMPERATURE	-55 to +105°C
STANDARD OPERATING TEMPERATURE	-25 to +60°C <sup>*4</sup> (CASE)
EXTENDED OPERATING TEMPERATURE	-55 to +70°C <sup>*4</sup> (CASE) [Q models / 0.5W]

INPUT CURRENT		
Q MODELS - 0.50 Watt		
VIN	NO-LOAD	FULL-LOAD
5 VDC	<250 mA	<400 mA
12 VDC	<100 mA	<250 mA
15 VDC	<75 mA	<125 mA
24 VDC	<35 mA	<75 mA

0 TO 5V ONLY (FOR MODELS OVER 3KV)

ELECTRICAL SPECIFICATIONS<sup>\*3</sup> (6,000V - 10,000V)

Q MODELS - 0.50 Watt			
OUTPUT VOLTAGE <sup>*2</sup>	MODEL	MAXIMUM OUTPUT CURRENT <sup>*1</sup>	RIPPLE P-P
<b>POSITIVE</b>			
0 to +6,000 VDC	Q60	83 $\mu$ A	<1.000 %
0 to +8,000 VDC	Q80	62.5 $\mu$ A	<1.000 %
0 to +10,000 VDC	Q101	50 $\mu$ A	<1.000 %
<b>NEGATIVE</b>			
0 to -6,000 VDC	Q60N	83 $\mu$ A	<1.000 %
0 to -8,000 VDC	Q80N	62.5 $\mu$ A	<1.000 %
0 to -10,000 VDC	Q101N	50 $\mu$ A	<1.000 %

PARAMETER	VALUE
INPUT VOLTAGE	0 to 5 VOLTS
TYPICAL TURN-ON VOLTAGE	<0.7 VOLTS
ISOLATION	< +/- 500 VDC BIAS ON OUTPUT RETURN (W4)
OUTPUT VOLTAGE TOLERANCE	+10%, -10% (AT 100% OUTPUT, FULL LOAD)
FREQUENCY	75-500KHZ (TYPICAL)
STANDARD TEMPERATURE RANGES	OPERATING: -10 TO +60°C <sup>*4</sup> (CASE)
	STORAGE: -20° TO +105°C

INPUT CURRENT		
Q MODELS - 0.50 Watt		
VIN	NO-LOAD	FULL-LOAD
5 VDC	<175 mA	<250 mA

## BLOCK DIAGRAM

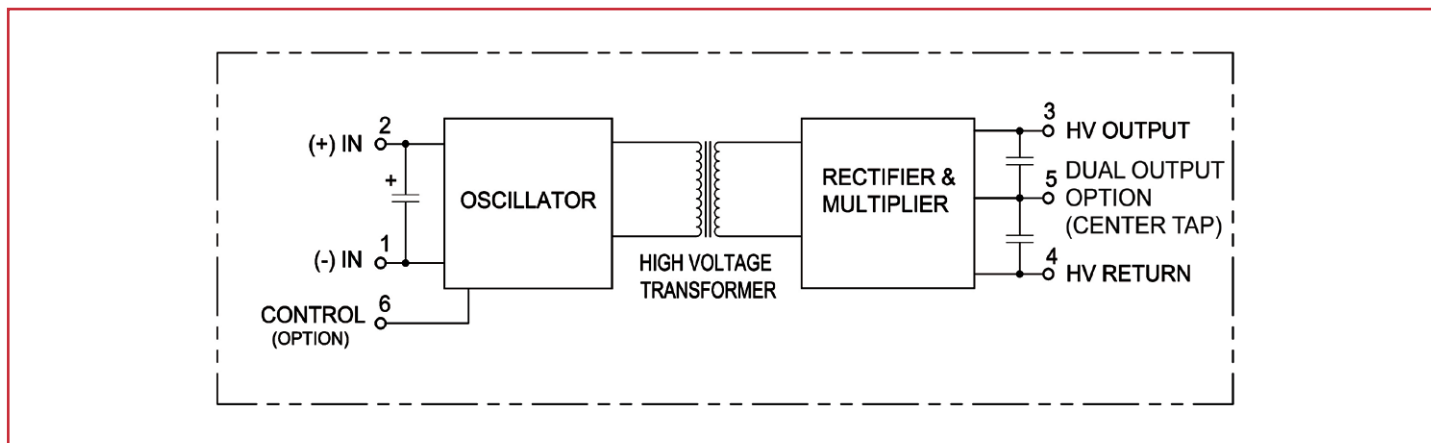

NOTE: Pin designators for pin out models up to 5KV.

## COPPER SHIELD PLACEMENT

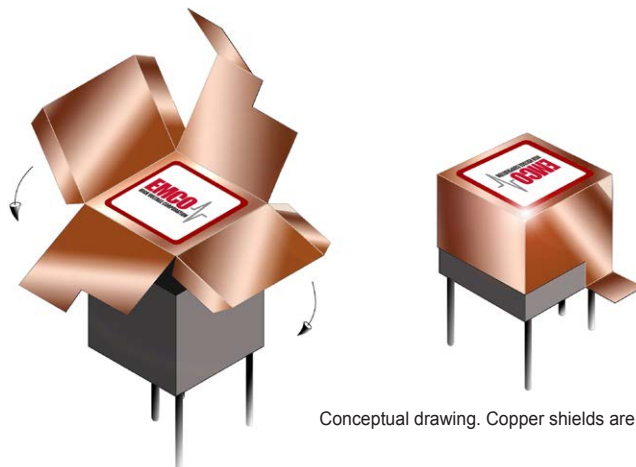

Conceptual drawing. Copper shields are factory installed.

## DETAILED PRODUCT DESCRIPTION

The Q Series is a broad line of ultra-miniature, high reliability DC to HV DC converters supplying up to 5,000 volts in only 0.125 cubic inches and up to 10,000 volts in only 0.614 cubic inches. These component-sized converters are ideal for applications requiring minimal size and weight. The output is directly proportional to the input voltage and is linear from <math><0.7V</math> input to maximum input voltage, allowing for an adjustable output voltage. Output is load dependent. A control pin option allows full control of the output via a high impedance input, ideal for error-amplifier control in closed-loop systems. Isolation is <math>\pm 500V</math> bias on output return and output power is either 0.5 watt or 1.25 watts. No external components or minimum load are

required. The output ripple is extremely low for this package size, as low as .1%. Light weight and wide temperature range make these units ideal for portable, battery-powered equipment. Many models feature a dual output (center tap) option, which creates both a positive and a negative output from miniature, one low cost unit. An alternate pin pattern is available for users wishing to upgrade without modifying their board design. Output is load dependent.

Application notes are available on this series, and technical assistance is readily available.

MECHANICAL SPECIFICATIONS (100V - 2,000V)

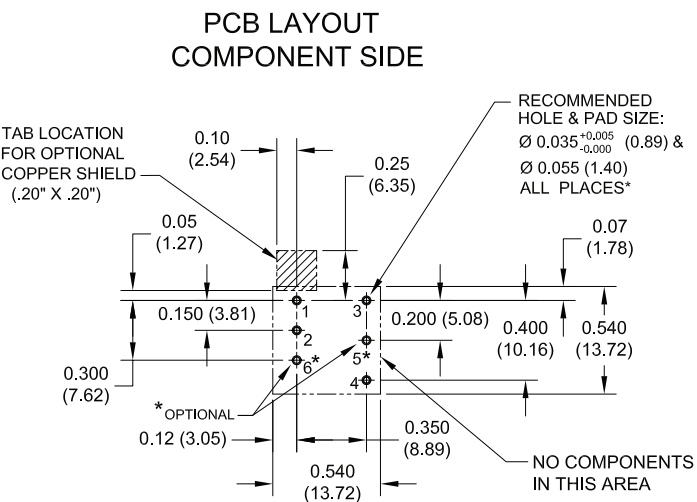
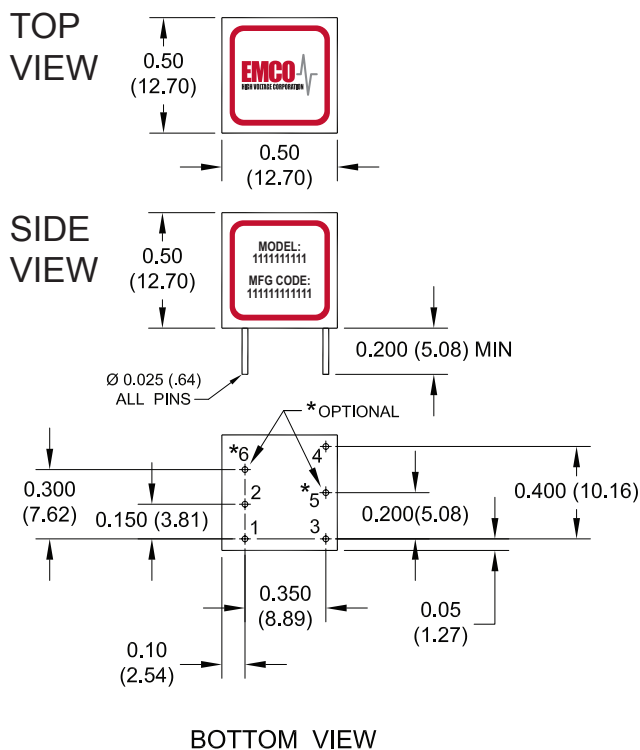

\*OPTIONAL

DIMENSIONS ARE IN INCHES (METRIC EQUIVALENTS ARE IN PARENTHESIS)  
 DIMENSIONAL TOLERANCES: .XX = ±0.02 (0.51), .XXX = ±0.005 (0.127)

PARAMETER	VALUE
WEIGHT	0.15 OUNCES APPROX. (4.25 GRAMS)
VOLUME	0.125 CUBIC INCHES (2.05CM <sup>3</sup> )
DIMENSIONS	0.50L (12.7) X 0.50W (12.7) 0.50H (12.7)

PIN #	100V TO 900V	1,000V TO 2,000V
1	INPUT (-)	INPUT (-)
2	INPUT (+)	INPUT (+)
3	OUTPUT (+)	HV OUTPUT
4	OUTPUT (-)	OUTPUT RETURN
5*	DUAL OUTPUT/CENTER TAP	
6*	CONTROL PIN	



MECHANICAL SPECIFICATIONS (2,500V - 5,000V)

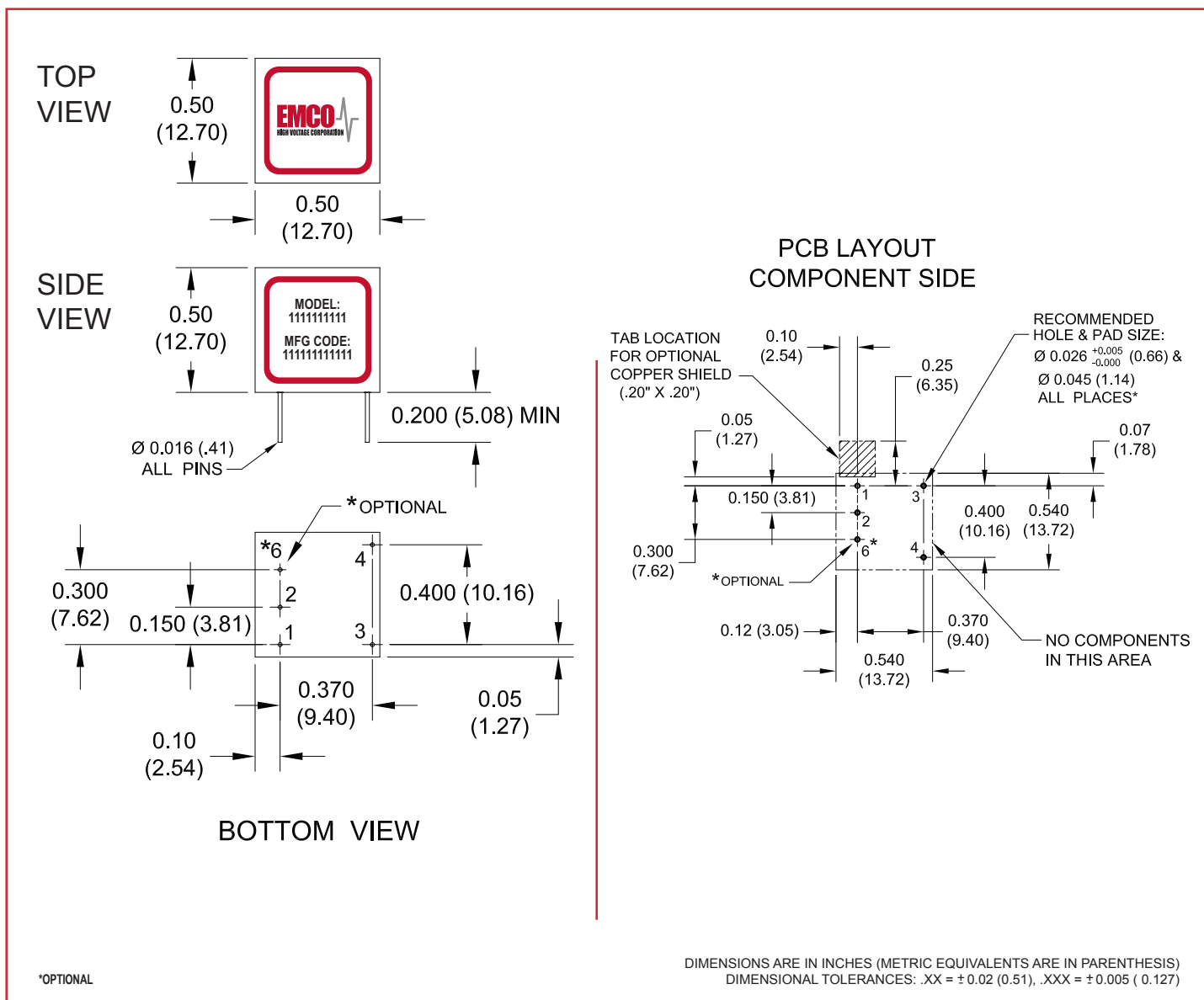

PARAMETER	VALUE
WEIGHT	0.15 OUNCES APPROX. (4.25 GRAMS)
VOLUME	0.125 CUBIC INCHES (2.05CM <sup>3</sup> )
DIMENSIONS	0.50L (12.7) X 0.50W (12.7) 0.50H (12.7)

PIN #	FUNCTION
1	INPUT (-)
2	INPUT (+)
3	HV OUTPUT
4	HV RETURN
5*	
6*	CONTROL PIN

MECHANICAL SPECIFICATIONS (6,000V - 10,000V)

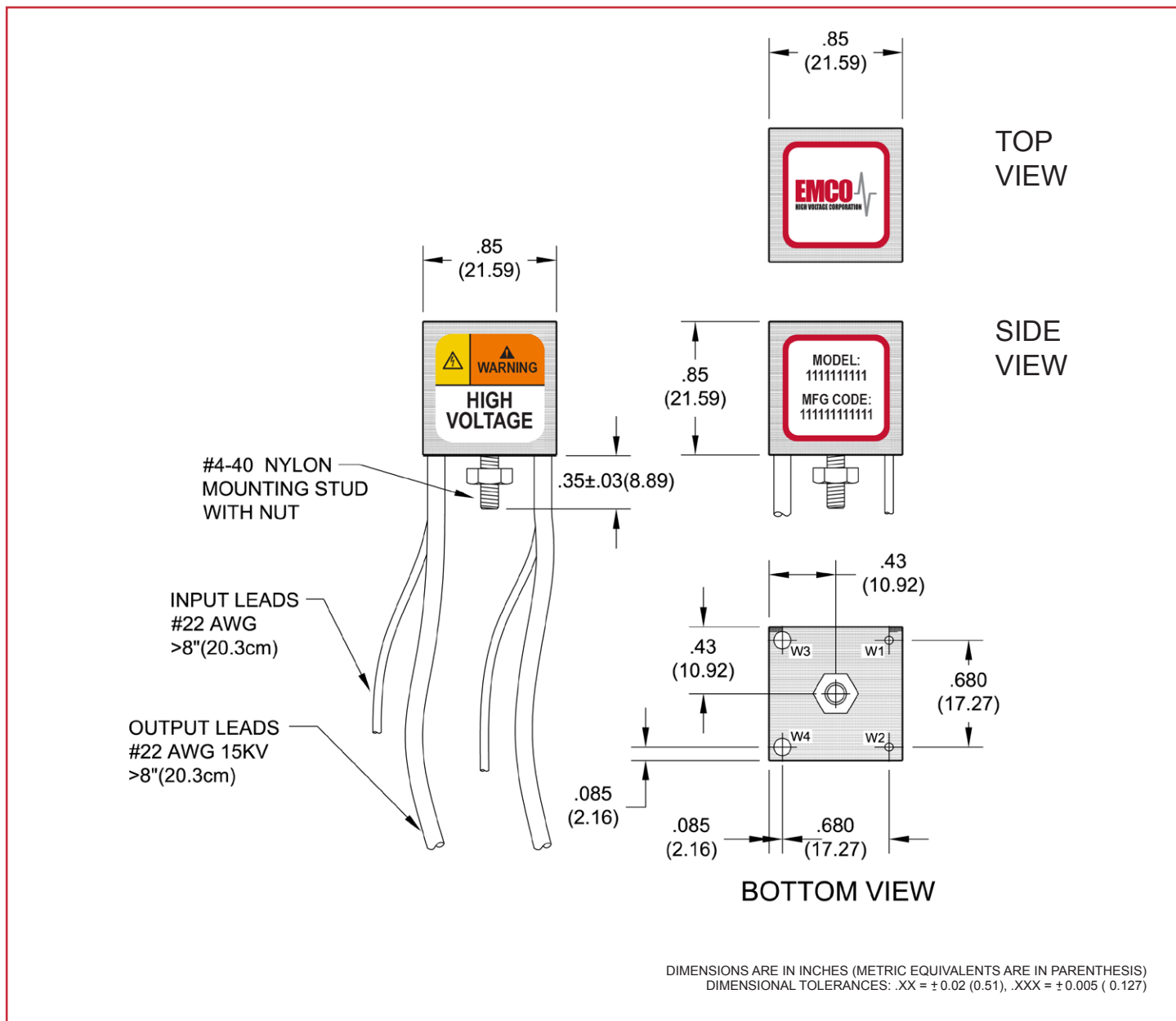

PARAMETER	VALUE
WEIGHT	1 OUNCE (28.3 GRAMS)
VOLUME	0.614 CU INCHES (10.06 CU CM)
DIMENSIONS	0.85L (21.59) X 0.85W (21.59) X 0.85H (21.59)

WIRE	COLOR	FUNCTION
1	RED	INPUT (+)
2	BLACK	INPUT (-)
3	BROWN	HV OUTPUT
4	VIOLET	HV RETURN

MECHANICAL SPECIFICATIONS, ALTERNATE PIN PATTERN (100V - 1,000V)

Not Recommended for New Designs

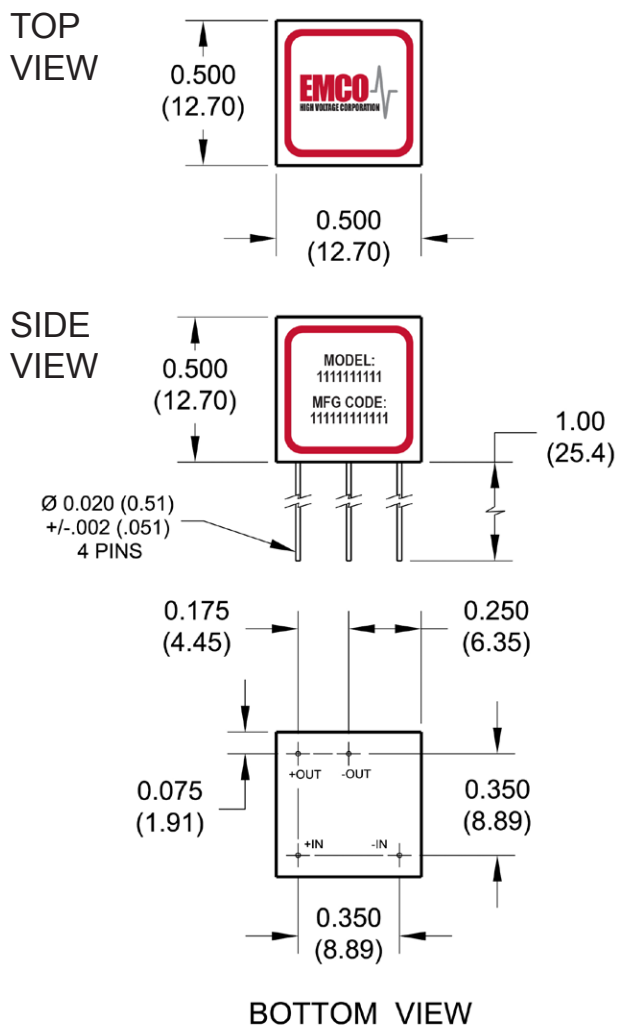

DIMENSIONS ARE IN INCHES (METRIC EQUIVALENTS ARE IN PARENTHESIS)  
 DIMENSIONAL TOLERANCES: .XX =  $\pm 0.02$  (0.51), .XXX =  $\pm 0.005$  (0.127)

PARAMETER	VALUE
WEIGHT	0.15 OUNCE (4.25 GRAMS)
VOLUME	0.125 CUBIC INCHES (2.05CM <sup>3</sup> )
DIMENSIONS	0.50L (12.7) X 0.50W (12.7) 0.50H (12.7)

PIN #	FUNCTION
1	INPUT (-)
2	INPUT (+)
3	HV OUTPUT
4	HV RETURN

MECHANICAL SPECIFICATIONS, ALTERNATE PIN PATTERN (1,500V - 5,000V)

Not Recommended for New Designs

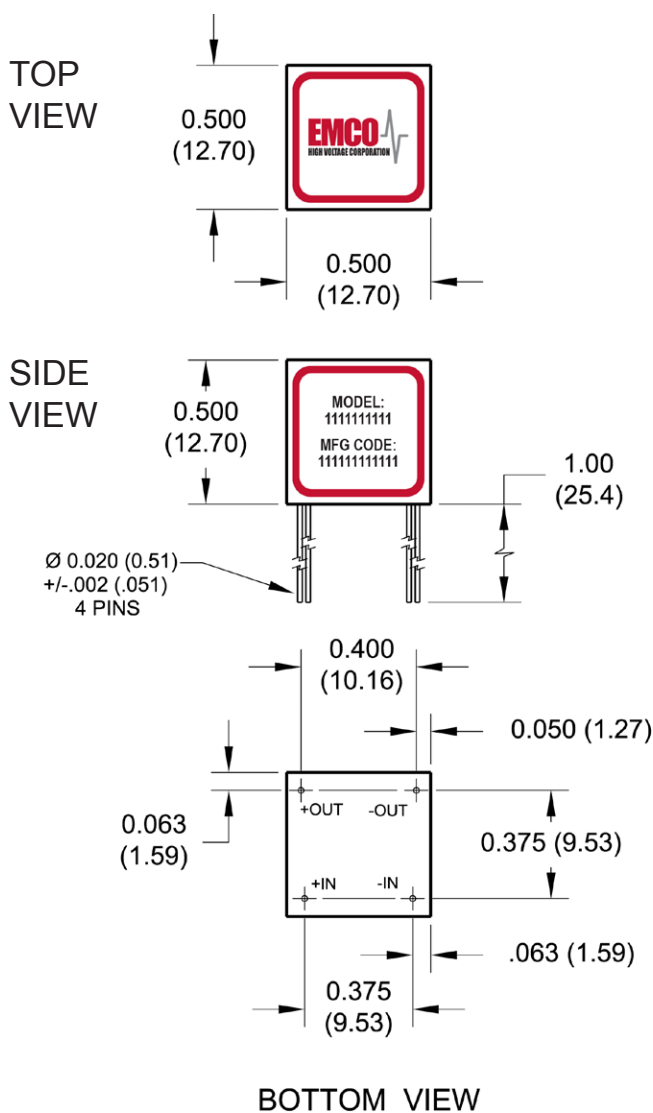

DIMENSIONS ARE IN INCHES (METRIC EQUIVALENTS ARE IN PARENTHESIS)  
 DIMENSIONAL TOLERANCES: .XX =  $\pm 0.02$  (0.51), .XXX =  $\pm 0.005$  (0.127)

PARAMETER	VALUE
WEIGHT	0.15 OUNCE (4.25 GRAMS)
VOLUME	0.125 CUBIC INCHES (2.05CM <sup>3</sup> )
DIMENSIONS	0.5L (12.7) X 0.5W (12.7) 0.5H (12.7)

PIN #	FUNCTION
1	INPUT (-)
2	INPUT (+)
3	HV OUTPUT
4	HV RETURN

APPLICATION NOTES

Typical HV Output vs. Control Voltage

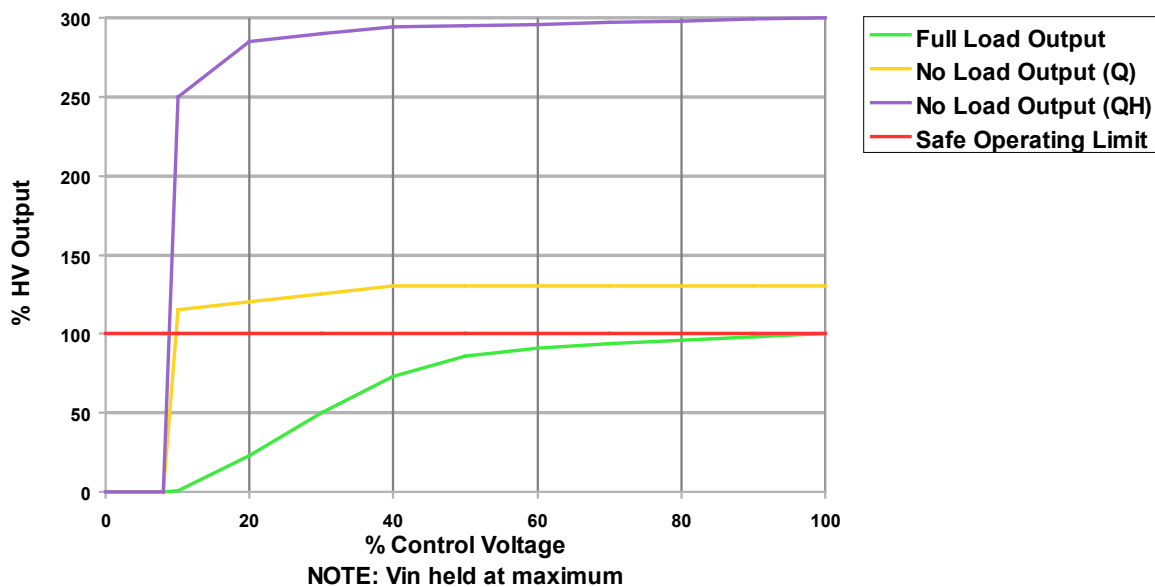

TYPICAL INPUT vs. OUTPUT VOLTAGE

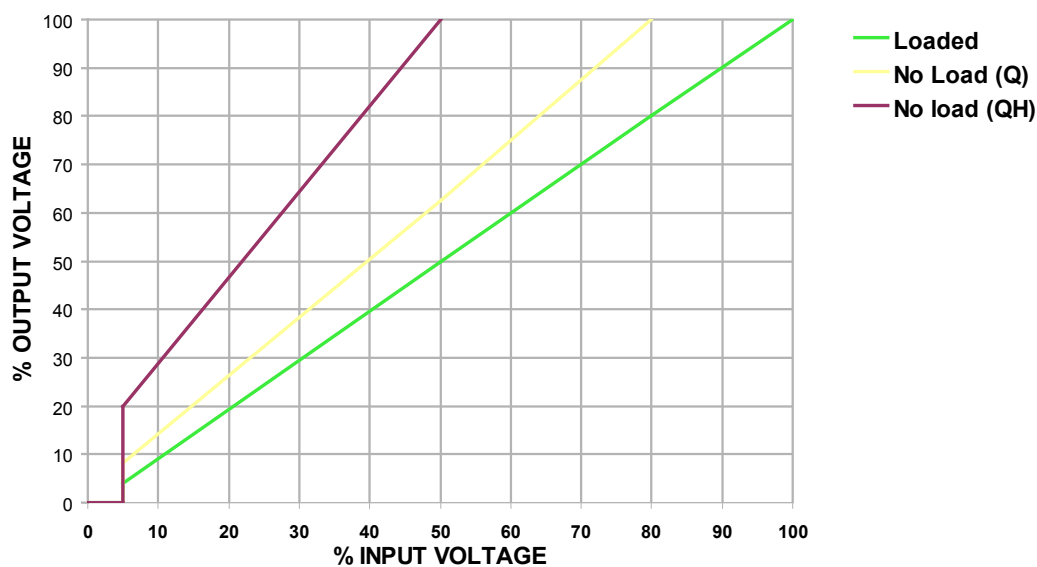

OPTION CODES

ORDERING INFORMATION		ORDER CODE	AVAILABILITY
TYPE	0.5 WATT	Q	ALL MODELS
	1.25 WATT	QH	UP TO 2KV
	1.25 WATT (Alternate Pin Pattern)*4	VA	UP TO 2KV
OUTPUT VOLTAGE	SEE TABLES		
POLARITY DESIGNATOR	POSITIVE OUTPUT	BLANK	
	NEGATIVE OUTPUT	N	
	DUAL OUTPUT (CENTER TAP) OPTION	CT	UP TO 900V
INPUT VOLTAGE	5 VDC	5	ALL MODELS
	12 VDC	12	UP TO 3KV
	15 VDC	15	UP TO 3KV
	24 VDC	24	UP TO 3KV
OPTIONS	CONTROL PIN	C	UP TO 5KV
	EXTENDED TEMP	T	UP TO 5KV, 0.5W
	External Copper Shield	S	ALL MODELS

HOW TO ORDER

PART NUMBER SELECTOR:

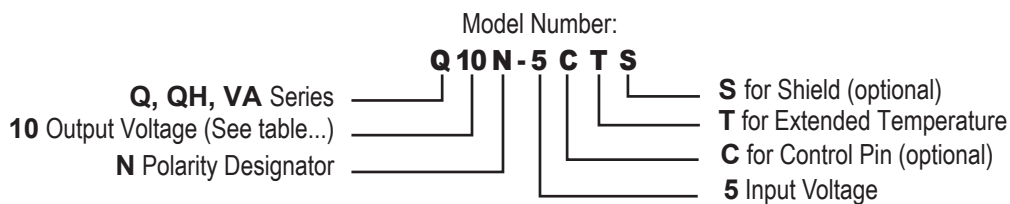

EXAMPLE

**Q10N-5CTS:** Q Series 0.5W, 1000 VDC, N negative, 5 VDC input, C for Control Pin, T for Extended Temperature, S for Shield.

\*Note:

1. At maximum rated output voltage
2. Output Voltage is load dependent. Under light or no-load conditions, reduce the Input Voltage so maximum rated Output Voltage is not exceeded.
3. Specifications are after 30 minute warm-up, full-load at 25°C, unless otherwise noted.
4. Proper thermal management techniques are required to maintain safe case temperature at maximum power output.
5. Ripple specification for dual output units applies to the voltage between the positive and negative output terminals.
6. For dual output units [CT option], the negative output voltage will be 10% larger than the positive output voltage with respect to the center tap pin.

XP-EMCO reserves the right to make changes on products and literature, including specifications, without notice. XP-EMCO standard product models are not recommended for "copy-exact" applications or any other application restricting product changes. "Copy-exact" options are available. Please contact an XP-EMCO sales representative for more details.