

# Analog Devices Welcomes Hittite Microwave Corporation

NO CONTENT ON THE ATTACHED DOCUMENT HAS CHANGED



# HMC321\* Product Page Quick Links

Last Content Update: 11/01/2016

---

## [Comparable Parts](#)

View a parametric search of comparable parts

## [Evaluation Kits](#)

- [HMC321LP4 Evaluation Board](#)

## [Documentation](#)

### **Data Sheet**

- [HMC321 Data Sheet](#)

## [Tools and Simulations](#)

- [HMC321 S-Parameter](#)

## [Reference Materials](#)

### **Quality Documentation**

- [Package/Assembly Qualification Test Report: LP4, LP4B, LP4C, LP4K \(QTR: 2013-00487 REV: 04\)](#)
- [Package/Assembly Qualification Test Report: Plastic Encapsulated QFN \(QTR: 05006 REV: 02\)](#)
- [Semiconductor Qualification Test Report: MESFET-F \(QTR: 2013-00247\)](#)

## [Design Resources](#)

- [HMC321 Material Declaration](#)
- [PCN-PDN Information](#)
- [Quality And Reliability](#)
- [Symbols and Footprints](#)

## [Discussions](#)

View all HMC321 EngineerZone Discussions

## [Sample and Buy](#)

Visit the product page to see pricing options

## [Technical Support](#)

Submit a technical question or find your regional support number

---

**THIS PAGE INTENTIONALLY LEFT BLANK**

# HMC321LP4 / 321LP4E

## GaAs MMIC SP8T NON-REFLECTIVE POSITIVE CONTROL SWITCH, DC\* - 8 GHz

### Typical Applications

This switch is suitable for usage in DC - 8.0 GHz 50-Ohm or 75-Ohm systems:

- Broadband
- Fiber Optics
- Switched Filter Banks
- Wireless below 8 GHz

### Features

Broadband Performance: DC - 8 GHz

High Isolation: >30 dB@ 6 GHz

Low Insertion Loss: 2.5 dB@ 6 GHz

Integrated Positive Supply 3:8 TTL Decoder

4x4 mm SMT Package

### Functional Diagram

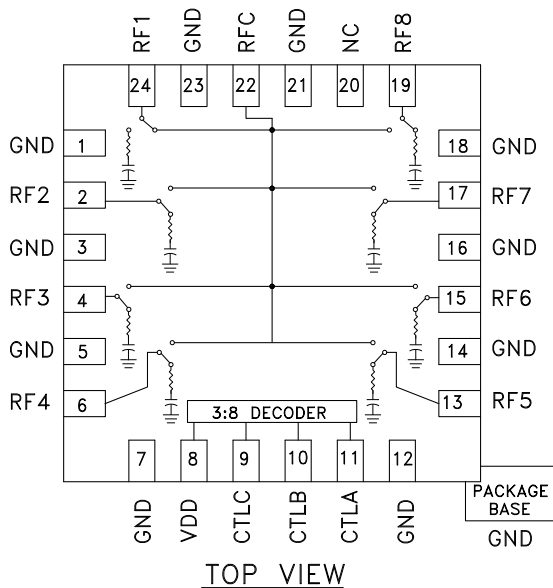

### General Description

The HMC321LP4 & HMC321LP4E are broadband non-reflective GaAs MESFET SP8T switches in low cost leadless surface mount packages. Covering DC to 8 GHz, this switch offers high isolation and low insertion loss. This switch also includes an on board binary decoder circuit which reduces the required logic control lines to three. The switch operates using a positive control voltage of 0/+5 volts, and requires a fixed bias of +5v. This switch is suitable for usage in 50-Ohm or 75-Ohm systems.

\* DC blocking capacitors are required at ports RFC and RF1, 2, 3, 4, 5, 6, 7, 8. Their value will determine the lowest transmission frequency.

### Electrical Specifications, $T_A = +25^\circ C$ , With 0/+5V Control, 50 Ohm System

Parameter	Frequency	Min.	Typ.	Max.	Units
Insertion Loss	DC - 2.0 GHz		2.3	2.7	dB
	DC - 4.0 GHz		2.5	2.9	dB
	DC - 8.0 GHz		2.7	3.1	dB
Isolation	DC - 2.0 GHz	35	40		dB
	DC - 4.0 GHz	30	35		dB
	DC - 6.0 GHz	25	30		dB
	DC - 8.0 GHz	20	25		dB
Return Loss	"On State"	DC - 4.0 GHz	8	12	dB
		DC - 8.0 GHz	7	10	dB
Return Loss (RF1 - RF8)	"Off State"	2.0 - 8.0 GHz	7	12	dB
Input Power for 1 dB Compression	0.5 - 8.0 GHz	19	23		dBm
Input Third Order Intercept (Two-tone Input Power = +7 dBm Each Tone, 1 MHz Spacing)	0.5 - 8.0 GHz	33	40		dBm
Switching Characteristics	DC - 8.0 GHz	tRISE, tFALL (10/90% RF)	50		ns
		tON, tOFF (50% CTL to 10/90% RF)	150		ns

For price, delivery, and to place orders, please contact Hittite Microwave Corporation:  
 20 Alpha Road, Chelmsford, MA 01824 Phone: 978-250-3343 Fax: 978-250-3373  
 Order On-line at [www.hittite.com](http://www.hittite.com)



## GaAs MMIC SP8T NON-REFLECTIVE POSITIVE CONTROL SWITCH, DC\* - 8 GHz

**Insertion Loss vs. Temperature**

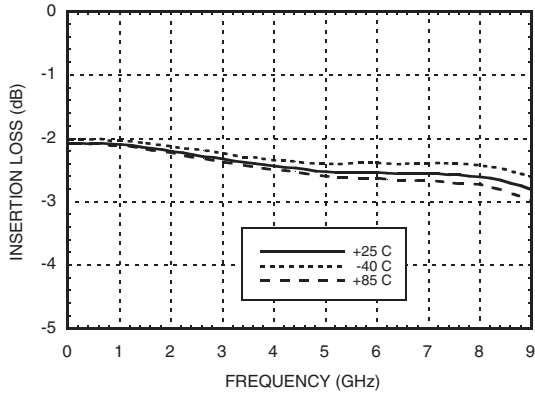

**Isolation**

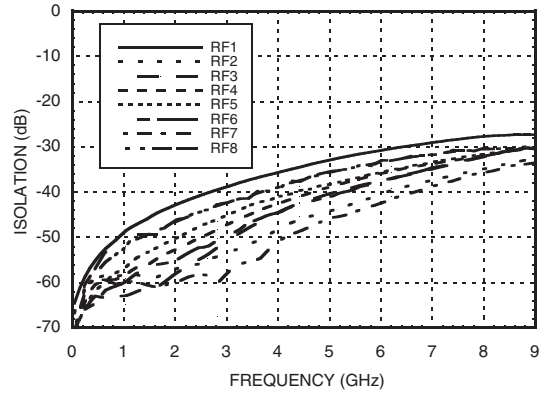

**Return Loss**

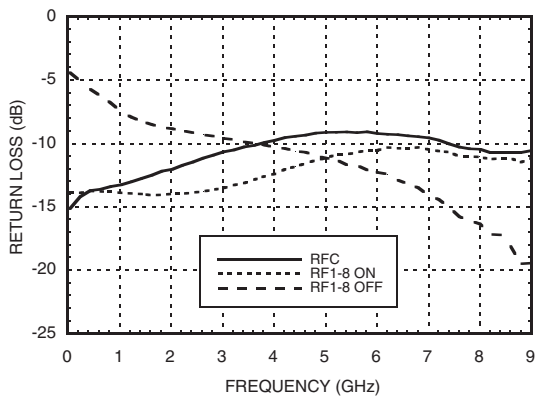

**0.1 and 1 dB Input Compression Point**

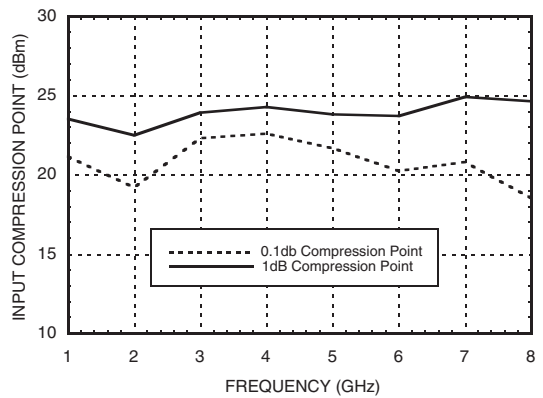

**Input Third Order Intercept Point**

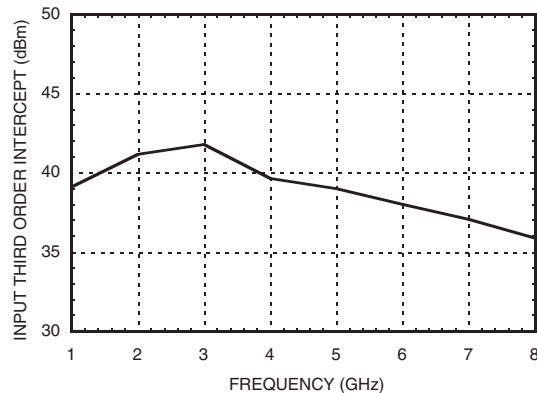



## GaAs MMIC SP8T NON-REFLECTIVE POSITIVE CONTROL SWITCH, DC\* - 8 GHz

### Bias Voltage & Current

Vdd Range = +5.0 Vdc ± 10%		
Vdd (Vdc)	Idd (Typ.) (mA)	Idd (Max.) (mA)
+5.0	5.0	9.0

### Control Voltages

State	Bias Condition
Low	0 to +0.8 Vdc @ 5 uA Typical
High	+2.0 to +5.0 Vdc @ 25 uA Typical

### Truth Table

Control Input			Signal Path State
A	B	C	RFCOM to:
Low	Low	Low	RF1
High	Low	Low	RF2
Low	High	Low	RF3
High	High	Low	RF4
Low	Low	High	RF5
High	Low	High	RF6
Low	High	High	RF7
High	High	High	RF8

**Note:**

DC blocking capacitors are required at ports RFC and RF1, 2, 3, 4, 5, 6, 7, 8. Their value will determine the lowest transmission frequency.

### Absolute Maximum Ratings

Bias Voltage Range (Port Vdd)	+7.0 Vdc
Control Voltage Range (A, B, & C)	-0.5V to Vdd +1.0 Vdc
Storage Temperature	-65 to +150 °C
Operating Temperature	-40 to +85 °C
Maximum Input Power Vdd = +5V	+26 dBm
ESD Sensitivity (HBM)	Class 1A



ELECTROSTATIC SENSITIVE DEVICE  
OBSERVE HANDLING PRECAUTIONS

### Outline Drawing

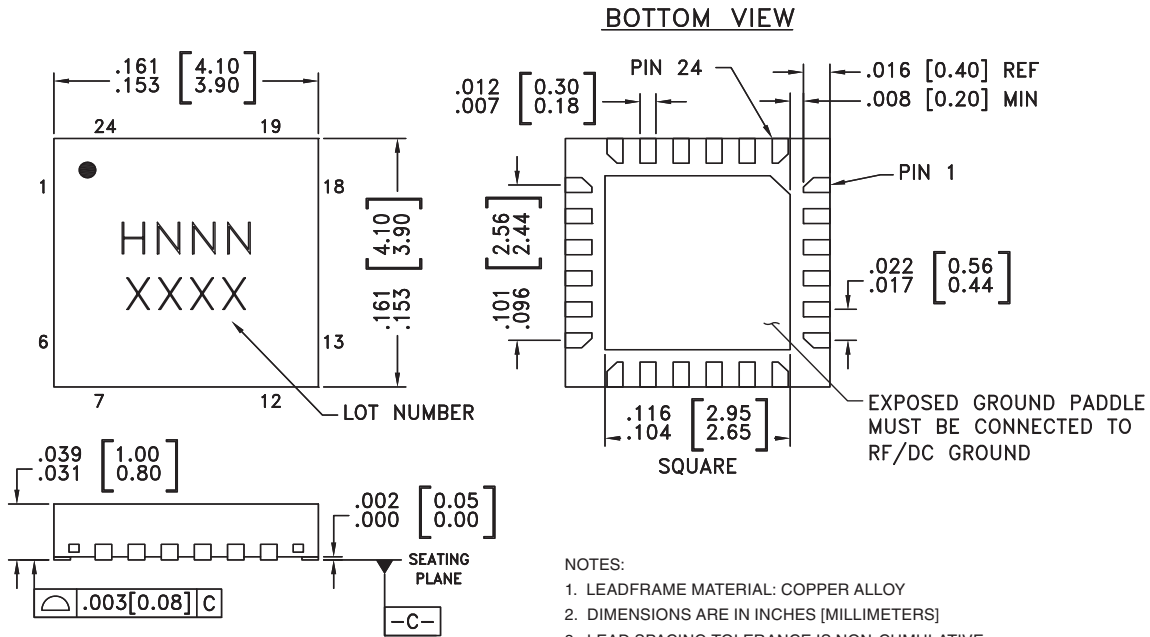

NOTES:

- LEADFRAME MATERIAL: COPPER ALLOY
- DIMENSIONS ARE IN INCHES [MILLIMETERS]
- LEAD SPACING TOLERANCE IS NON-CUMULATIVE.
- PAD BURR LENGTH SHALL BE 0.15mm MAXIMUM.  
PAD BURR HEIGHT SHALL BE 0.05mm MAXIMUM.
- PACKAGE WARP SHALL NOT EXCEED 0.05mm.
- ALL GROUND LEADS AND GROUND PADDLE MUST BE SOLDERED TO PCB RF GROUND.
- REFER TO HITTITE APPLICATION NOTE FOR SUGGESTED LAND PATTERN.

### Package Information

Part Number	Package Body Material	Lead Finish	MSL Rating	Package Marking <sup>[3]</sup>
HMC321LP4	Low Stress Injection Molded Plastic	Sn/Pb Solder	MSL1 <sup>[1]</sup>	H321 XXXX
HMC321LP4E	RoHS-compliant Low Stress Injection Molded Plastic	100% matte Sn	MSL1 <sup>[2]</sup>	H321 XXXX

[1] Max peak reflow temperature of 235 °C

[2] Max peak reflow temperature of 260 °C

[3] 4-Digit lot number XXXX



## GaAs MMIC SP8T NON-REFLECTIVE POSITIVE CONTROL SWITCH, DC\* - 8 GHz

### Pin Descriptions

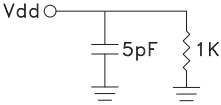
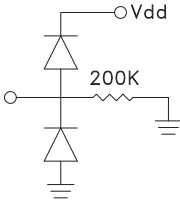
Pin Number	Function	Description	Interface Schematic
1, 3, 5, 7, 12, 14, 16, 18, 21, 23	GND	Package bottom has exposed metal paddle that must also be connected to PCB RF ground.	
2, 4, 6, 13, 15, 17, 19, 22, 24	RF1 - RF8 & RFC	This pin is DC coupled and matched to 50 Ohm. Blocking capacitors are required.	
8	VDD	Supply Voltage +5V ± 10%	
9	CTLC	See truth table and control voltage table.	
10	CTLB	See truth table and control voltage table.	
11	CTLA	See truth table and control voltage table.	
20	N/C	This pin should be connected to PCB RF ground to maximize isolation.	



### Evaluation PCB

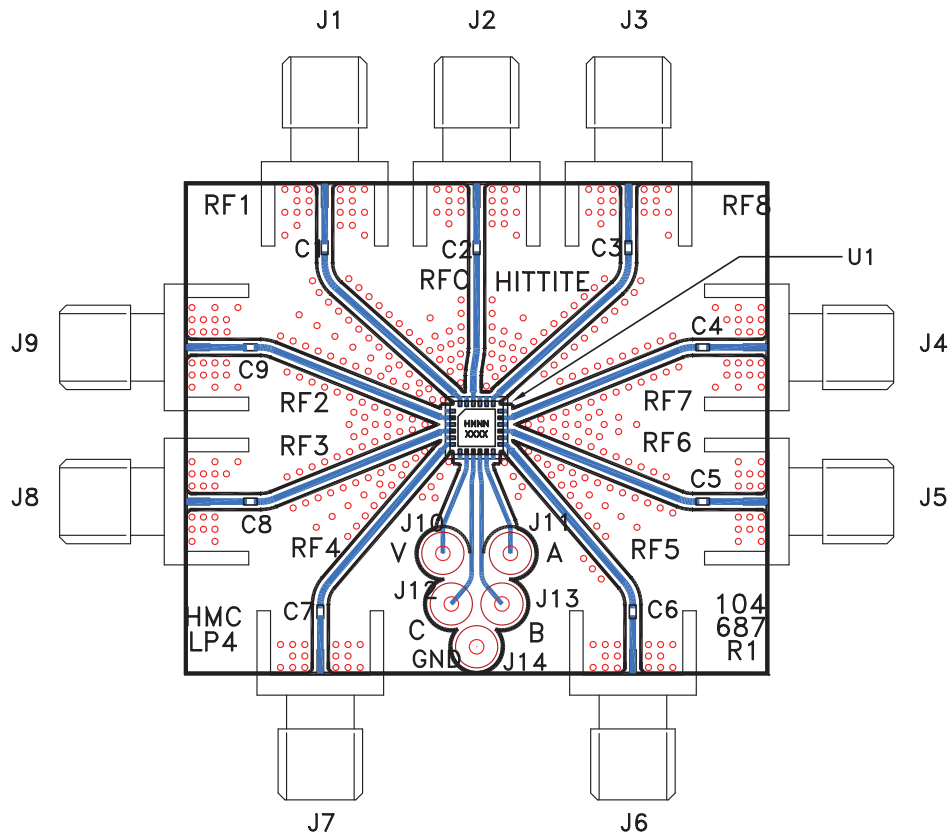

### List of Materials for Evaluation PCB 104769 [1]

Item	Description
J1 - J9	PCB Mount SMA RF Connector
J10 - J14	DC Pin
C1 - C9	100 pF Capacitor, 0402 Pkg.
U1	HMC321LP4 / HMC321LP4E SP8T Switch
PCB [2]	104687 Evaluation PCB 1.73" x 1.46"

[1] Reference this number when ordering complete evaluation PCB

[2] Circuit Board Material: Rogers 4350

The circuit board used in the final application should be generated with proper RF circuit design techniques. Signal lines at the RF port should have 50 ohm impedance and the package ground leads and backside ground slug should be connected directly to the ground plane similar to that shown above. The evaluation circuit board shown above is available from Hittite Microwave Corporation upon request.