

Analog Devices Welcomes Hittite Microwave Corporation

NO CONTENT ON THE ATTACHED DOCUMENT HAS CHANGED



HMC765* Product Page Quick Links

Last Content Update: 11/01/2016

[Comparable Parts](#)

View a parametric search of comparable parts

[Evaluation Kits](#)

- HMC765LP6CE Evaluation Board

[Documentation](#)

Data Sheet

- HMC765 Data Sheet

User Guides

- PLLs with Integrated VCO - Microwave Applications Product & Operating Guide

[Reference Materials](#)

Quality Documentation

- HMC Legacy PCN: LP6CE and LP6GE QFN - Alternate assembly source
- Package/Assembly Qualification Test Report: LP6, LP6C, LP6G (QTR: 2014-00368)
- Semiconductor Qualification Test Report: GaAs HBT-A (QTR: 2013-00228)

Technical Articles

- Low Cost PLL with Integrated VCO Enables Compact LO Solutions
- RF/Microwave PLLs Integrate Low Noise VCOs

[Design Resources](#)

- HMC765 Material Declaration
- PCN-PDN Information
- Quality And Reliability
- Symbols and Footprints

[Discussions](#)

View all HMC765 EngineerZone Discussions

[Sample and Buy](#)

Visit the product page to see pricing options

[Technical Support](#)

Submit a technical question or find your regional support number

THIS PAGE INTENTIONALLY LEFT BLANK



Features

- RF Bandwidth: 7.8 GHz to 8.8 GHz
- Fractional or Integer Modes
- Ultra Low Phase Noise
8.3 GHz; 50 MHz Ref.
-97 / -101 dBc/Hz @ 10 kHz (Frac / Int)
-140 dBc/Hz @ 1 MHz (Open Loop)
- Figure of Merit (FOM)
-221 / -226 dBc/Hz (Frac / Int)
- 24-bit Step Size, Resolution 3 Hz typ
- 225 MHz, 14-bit reference path input
- Direct FSK Modulation Mode
- Cycle Slip Prevention
- Read / Write Serial Port, Chip ID
- 40 Lead 6 x 6 mm SMT Package: 36 mm²

Typical Applications

- VSAT Radio
- Point-to-Point / Multi-Point Radio
- Test Equipment & Industrial Control
- Military End-Use
- Phased Array Applications

Functional Diagram

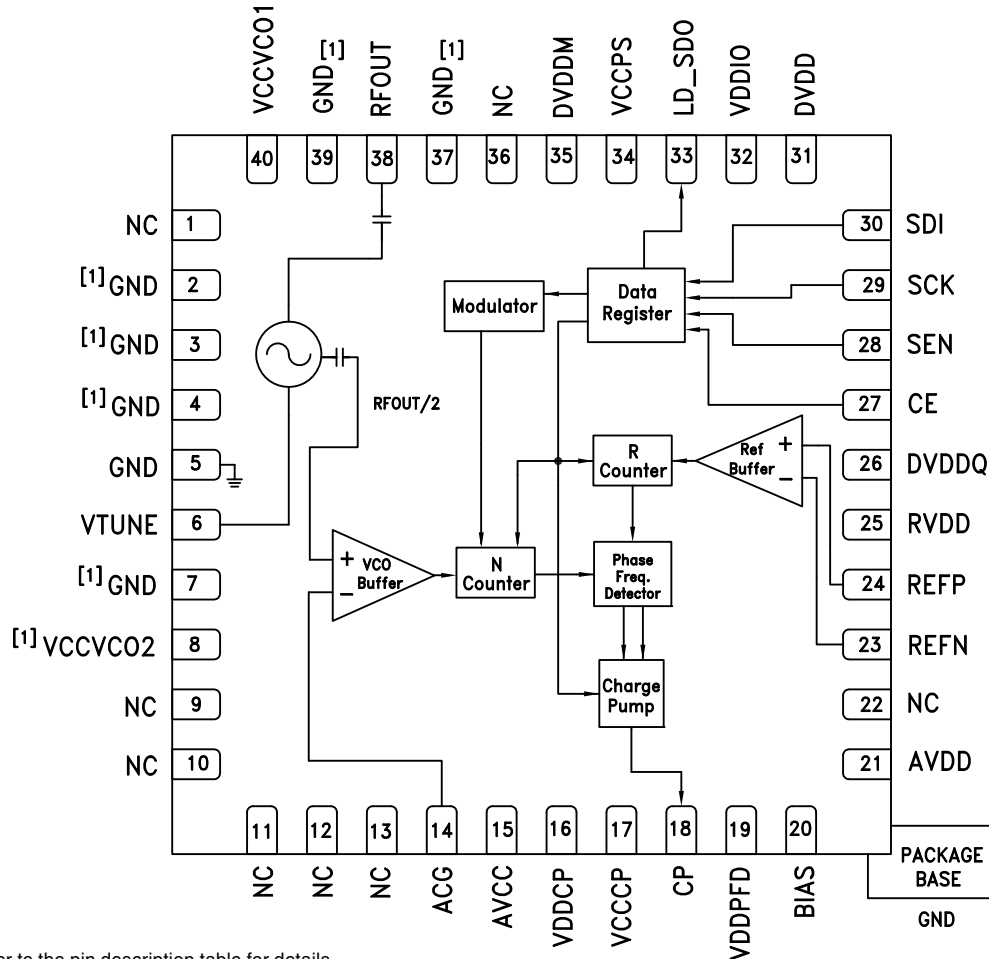

[1] Please refer to the pin description table for details



General Description

The HMC765LP6CE is a fully featured Fractional-N Phase-Locked-Loop (PLL) with an Integrated Voltage Controlled Oscillator (VCO). The input reference frequency range is 100 kHz to 220 MHz while the advanced delta-sigma modulator design in the fractional PLL allows both ultra-fine step sizes and very low spurious products. The highly integrated structure provides excellent phase noise performance over temperature, shock and process. The HMC765LP6CE is packaged in a leadless QFN 6 x 6 mm surface mount package. The output power is 13 dBm typical, making the HMC765LP6CE ideal for driving the LO port of many of Hittite's Hi Linearity and I/Q mixer products.

For theory of operation and register map refer to the "PLLs w/ Integrated VCO - Microwave VCOs" Operating Guide. To view the [Operating Guide](#), please visit www.hittite.com and choose HMC765LP6CE from the "Search by Part Number" pull down menu.

Electrical Specifications, $T_A = +25^\circ\text{C}$; VCCVCO, VDDCP, VCCCP = +5V; AVCC, VCCPS VDDPFD, AVDD, RVDD, DVDD, DVDDM, DVDDQ, VDDIO = +3.3V; AGND = DGND = 0V

Parameter	Condition	Min.	Typ.	Max.	Units
RF Output Characteristics					
VCO Output Frequency Range		7.8	8.3	8.8	GHz
VCO Output Power		10		15	dBm
VCO Tuning Voltage		2		13	V
VCO Tuning Sensitivity	$V_{TUNE} = +5V$		150		MHz/V
Frequency Pulling (into a 2:1 VSWR)			5		MHz pp
Frequency Pushing	$V_{TUNE} = +5V$		10		MHz/V
Frequency Drift Rate			0.9		MHz/°C
Sub Harmonic (1/2)			35		dBc
Harmonic (2 nd)			10		dBc
Harmonic (3 rd)			32		dBc
VCO SSB Phase Noise @ 100 kHz Offset (Open Loop)	$V_{TUNE} = +5V$ $F_{VCO} = 8.3\text{ GHz}$		-115		dBc/Hz
Synthesizer In-Band SSB Phase Noise @ 10 kHz Offset (Frac/Int)	$F_{ref} = 50\text{ MHz}$ $F_{vco} = 8.3\text{ GHz}$ Loop BW = 100 kHz		-97 / -101		dBc/Hz
Synthesizer Normalized In-Band SSB Phase Noise Floor (Frac/Int)			-221 / -226		dBc/Hz
Synthesizer Fractional Spurs [1]			-65		dBc
Synthesizer Frequency Settling Time (100 MHz Step)	From 8.3 GHz to 8.4 GHz Loop BW = 100 kHz		110		μs
16-Bit Divider Range (Int)	N Divider Ratio $2^{16}+31$	32		65567	
16-Bit Divider Range (Frac)	N Divider Ratio $2^{16}-1$	36		65535	
REF Input Characteristics					
Max Ref Input Frequency (3.3V)		200	225		MHz
Min Ref Input Frequency			100	200	kHz
Ref Input Sensitivity	AC Coupled		500	700	mV _{pp}
Max Ref Input	DC Coupled	0		VDDIO	V
Ref Input Capacitance				5	pF
14-Bit Ref Divider Range		16383		1	

[1] Actual spur level is dependent on loop parameters and will increase at division ratios closest to integer boundaries. Number listed is average value.

**FRACTIONAL-N PLL WITH
INTEGRATED VCO, 7.8 - 8.8 GHz**
Electrical Specifications (Continued)

Parameter	Condition	Min.	Typ.	Max.	Units
Phase Detector					
Max Phase Detector Frequency (Frac)		70	105		MHz
Max Phase Detector Frequency (Int)		140	160		MHz
Min Phase Detector Frequency				100	kHz
Charge Pump					
Max Output Current		2			mA
Min Output Current		500			μ A
Charge Pump Noise	Input referred 50 MHz Ref.		-145		dBc/Hz
Logic Inputs					
VIH Input High Voltage		VDDIO-0.4		VDDIO	V
VIL Input Low Voltage		0		0.4	V
Logic Outputs					
VOH Output High Voltage		VDDIO-0.4		VDDIO	V
VOL Output Low Voltage		0		0.4	V
Serial Port Max Clock			50		MHz
Power Supply Voltages					
Analog 3.3V Supplies: AVCC, VDDPFD, AVDD, RVDD, VCCPS	AVDD must equal DVDD	3	3.3	3.45	V
Digital Internal Supplies: DVDD, DVDDQ, DVDDM		3	3.3	3.45	V
Digital I/O Supplies: VDDIO	Logic I/O	1.8	3.3	5.5	V
Analog 5V Supplies: VCCVCO, VDDCP, VCCCP	VCCCP must equal VDDCP	4.75	5	5.25	V
Power Supply Currents					
Total Current Consumption (5V)			245	290	mA
Total Current Consumption (3.3V)			90	110	mA
Power Down Current ^[1]	CSP Disabled		1	10	μ A
	CSP Enabled		450		μ A
Bias Reference Voltage	Measured with 10 G Ω meter	1.880	1.920	1.960	V

[1] Refers only to the Synthesizer portion of the HMC765LP6CE



FRACTIONAL-N PLL WITH INTEGRATED VCO, 7.8 - 8.8 GHz

SSB Phase Noise vs. Frequency, Integer Mode

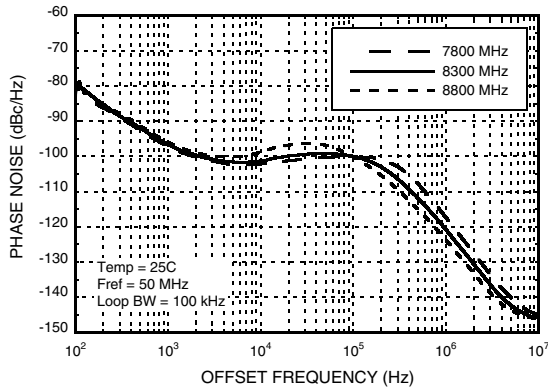

SSB Phase Noise vs. Temperature @ 8.3 GHz, Integer Mode

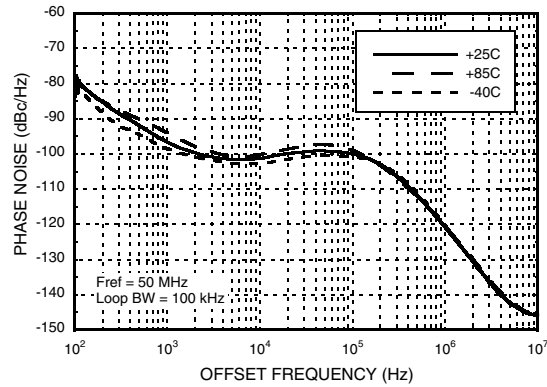

SSB Phase Noise Fractional Spurs @ 8.302 GHz

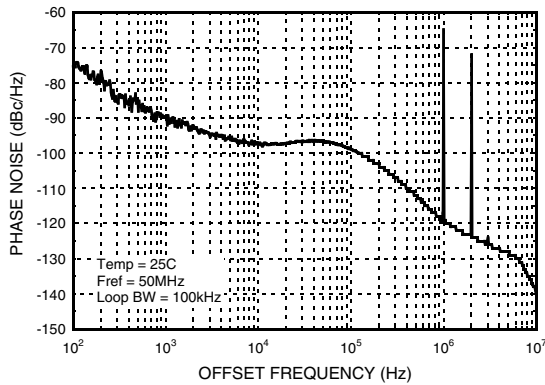

SSB Phase noise vs. Reference Freq. & Loop BW @ 8.3 GHz, Integer Mode

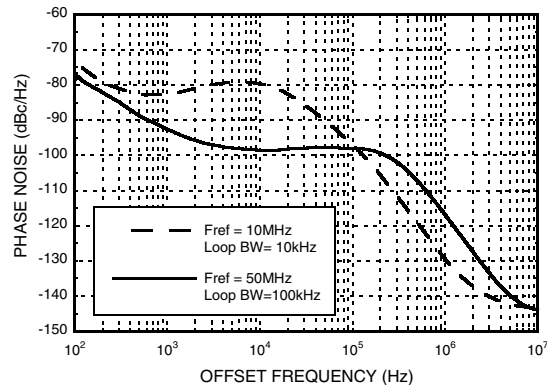

Example of Cycle Slip Prevention Hop from 8.6 to 8.1 GHz

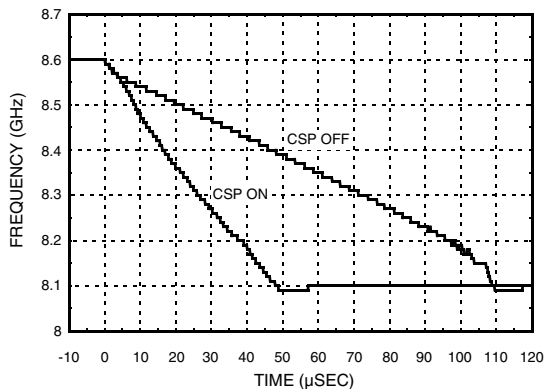

Typical Reference Sensitivity vs. Frequency, 3.3V [1]

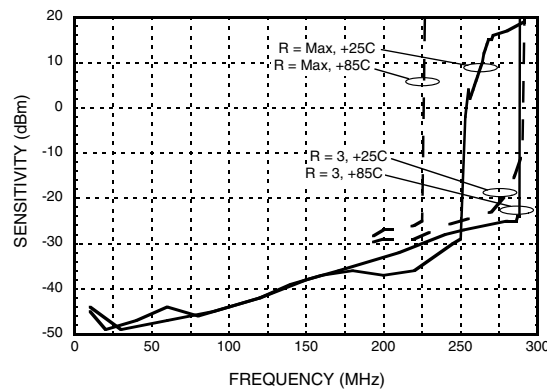

[1] R refers to the reference path division ratio



FRACTIONAL-N PLL WITH INTEGRATED VCO, 7.8 - 8.8 GHz

Frequency vs. Tuning Voltage, T = 25°C

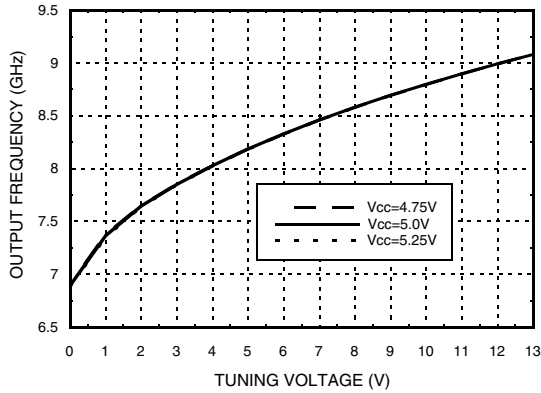

Frequency vs. Tuning Voltage, Vcc = +5V

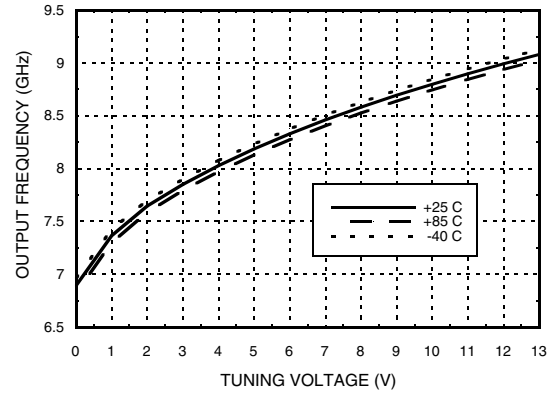

Sensitivity vs. Tuning Voltage, Vcc = +5V

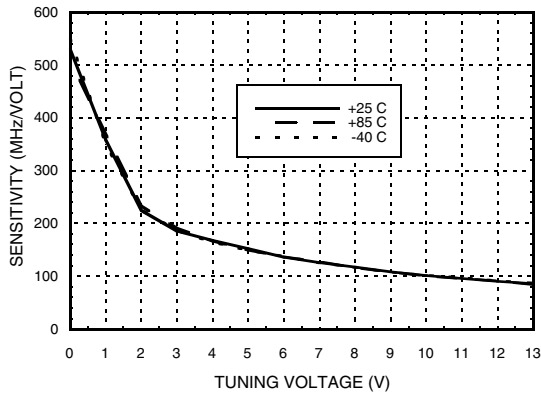

Output Power vs. Tuning Voltage, Vcc = +5V

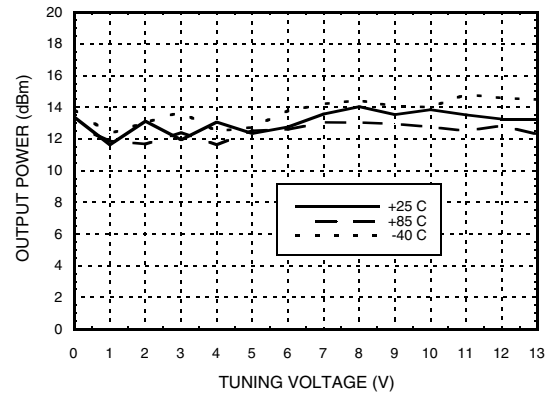

Open Loop VCO SSB Phase Noise @ Vtune = +5V

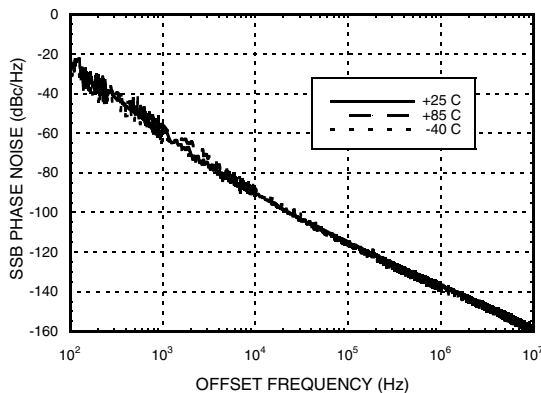

Open Loop VCO SSB Phase Noise vs. Tuning Voltage

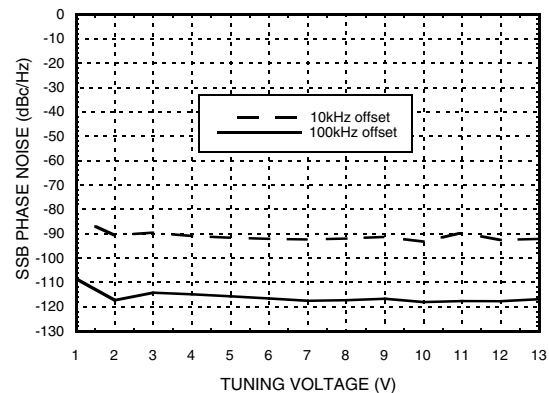

7

PLLS w/ INTEGRATED VCO - SMT



FRACTIONAL-N PLL WITH INTEGRATED VCO, 7.8 - 8.8 GHz

Pin Descriptions

Pin Number	Function	Description
1, 9 - 13, 22, 36	N/C	No Connection. These pins may be connected to RF/DC ground. Performance will not be affected.
2 - 4, 7, 37, 39	GND [1]	These pins must be connected to RF/DC Ground
5	GND	These pins and package bottom must be connected to RF/DC Ground
8	VCCVCO2 [2]	+5V Power Supply for VCO
40	VCCVCO1	
6	VTUNE	Control Voltage Input. Modulation port bandwidth dependent on drive source impedance.
14	ACG	AC Ground. This pin must be connected to an external capacitor to ground.
15	AVCC	Analog Power supply pin for the RF Section. A decoupling capacitor to the ground plane should be placed as close as possible to this pin. Nominally 3.3V
16	VDDCP	+5V Power Supply for charge pump digital section
17	VCCCP	+5V Power Supply for the charge pump analog section
18	CP	Charge pump output
19	VDDPFD	Analog Power supply for the phase frequency detector, Nominally 3.3V
20	BIAS [3]	External bypass decoupling for precision bias circuits, 1.920V ±20 mV is generated internally
21	AVDD	Analog Power supply for analog ref paths, Nominally 3.3V
23	REFN	Reference input (Negative or AC coupled to GND)
24	REFP	Reference input (Positive)
25	RVDD	Ref path supply
26	DVDDQ	Digital supply for Substrate, Nominally 3.3V
27	CE	Chip Enable
28	SEN	Serial port latch enable input
29	SCK	Serial port clock input
30	SDI	Serial port data input
31	DVDD	Power supply pin for internal digital circuitry. Nominally 3.3V
32	VDDIO	Power Supply for digital I/O driver
33	LD_SDO	Lock Detect, Main Serial Data Output or VCO Serial Port Data Out
34	VCCPS	Analog Power Supply for Prescaler, Nominally 3.3V
35	DVDDM	Digital Power Supply for M-Counter, Nominally 3.3V
38	RFOUT	RF output (AC coupled).

[1] This pin is not connected internally, however, this pin must be connected to GND to maintain product family pin for pin compatibility.



[2] This pin is not connected internally, however, this pin must be connected to Vcc to maintain product family pin for pin compatibility.

[3] BIAS ref voltage (pin 20) cannot drive an external load, and must be measured with a 10 GOhm meter such as Agilent 34410A; a typical 10 Mohm DVM will read erroneously.

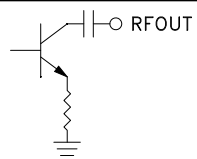
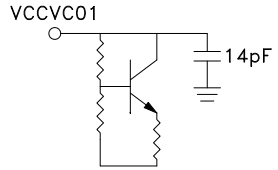
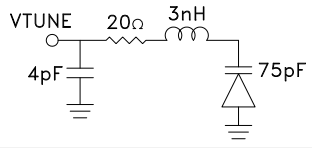

**FRACTIONAL-N PLL WITH
INTEGRATED VCO, 7.8 - 8.8 GHz**

Pin Schematic Equivalents

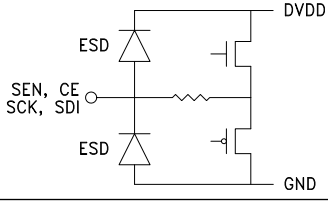
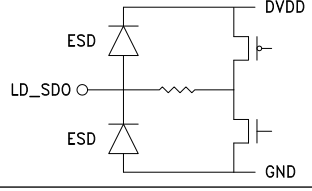
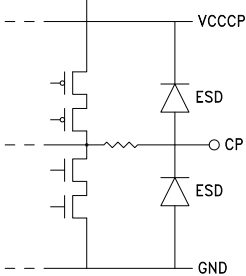
Pins	Equivalent Schematic
RFOUT	
VCCVCO1	
VTUNE	
GND	
SEN, CE, SCK, SDI	
LD_SDO	
CP	

7

PLLS w/ INTEGRATED VCO - SMT

Pin Schematic Equivalents (Continued)

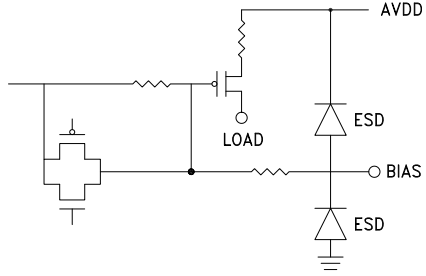
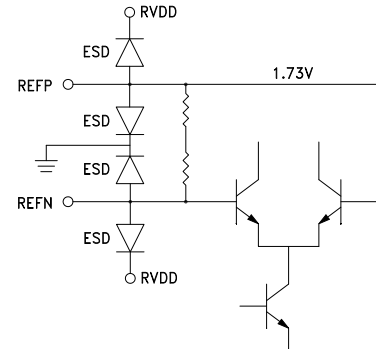
Pins	Equivalent Schematic
Bias	 <p>The schematic shows a network of resistors, capacitors, and a diode connected to the Bias pin. It is connected to AVDD, a LOAD, and ground through ESD diodes.</p>
REFN, REFP	 <p>The schematic shows a differential pair of transistors with a 1.73V bias. The REFN and REFP pins are connected to the nodes through ESD diodes. It is also connected to RVDD and ground.</p>



FRACTIONAL-N PLL WITH INTEGRATED VCO, 7.8 - 8.8 GHz

Evaluation Circuit

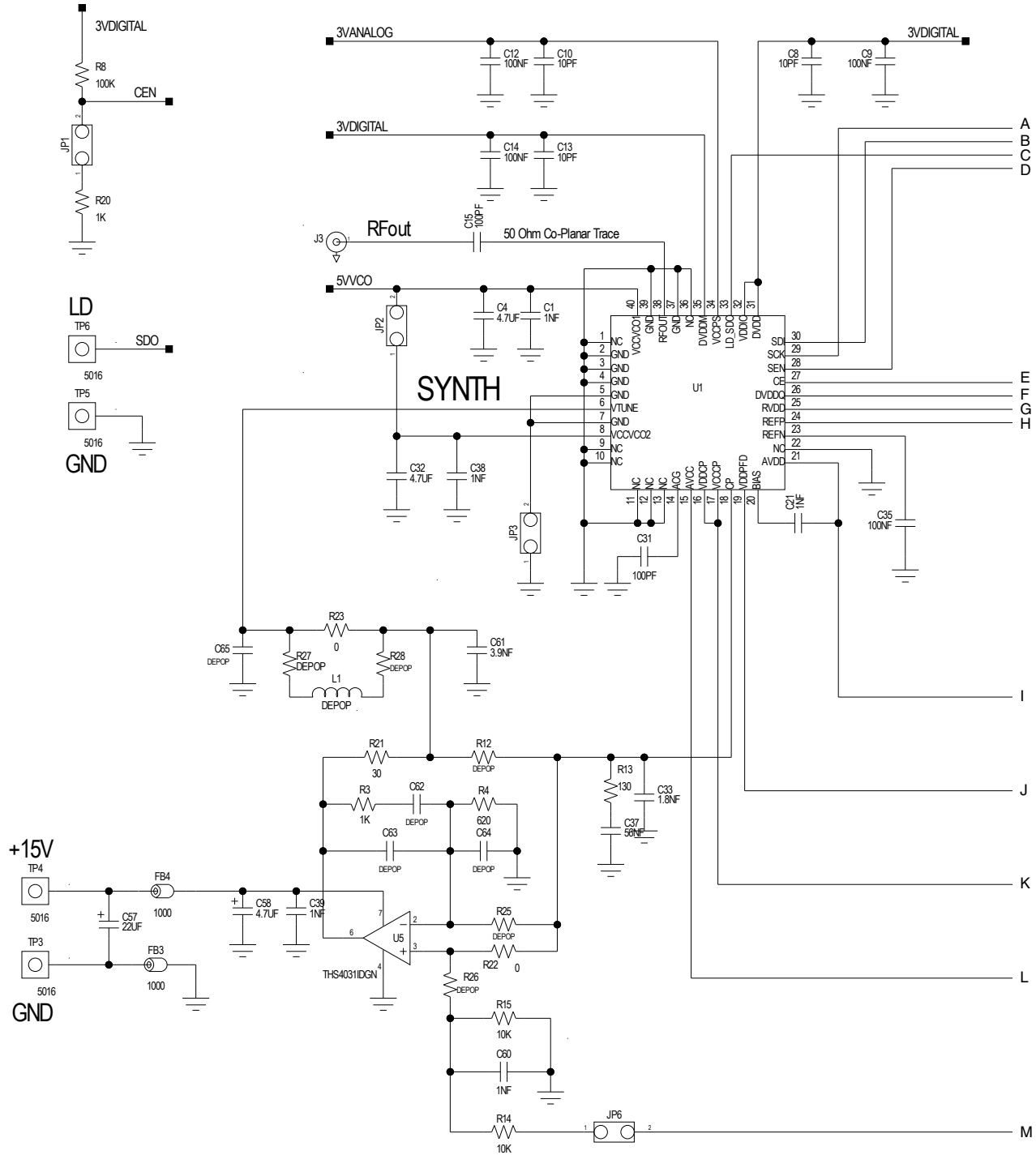



**FRACTIONAL-N PLL WITH
INTEGRATED VCO, 7.8 - 8.8 GHz**

Evaluation Circuit (Continued from page 9)

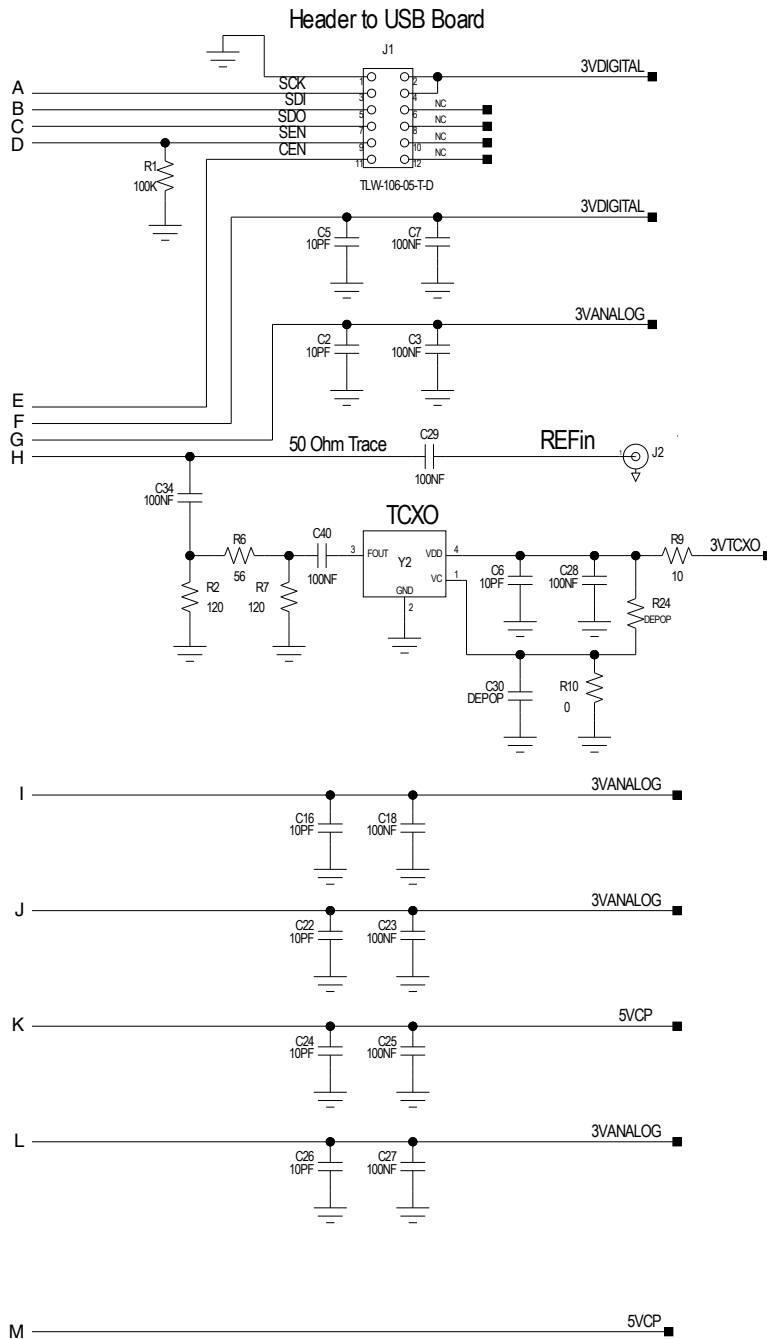



FRACTIONAL-N PLL WITH INTEGRATED VCO, 7.8 - 8.8 GHz

Evaluation Circuit (Continued from page 10)

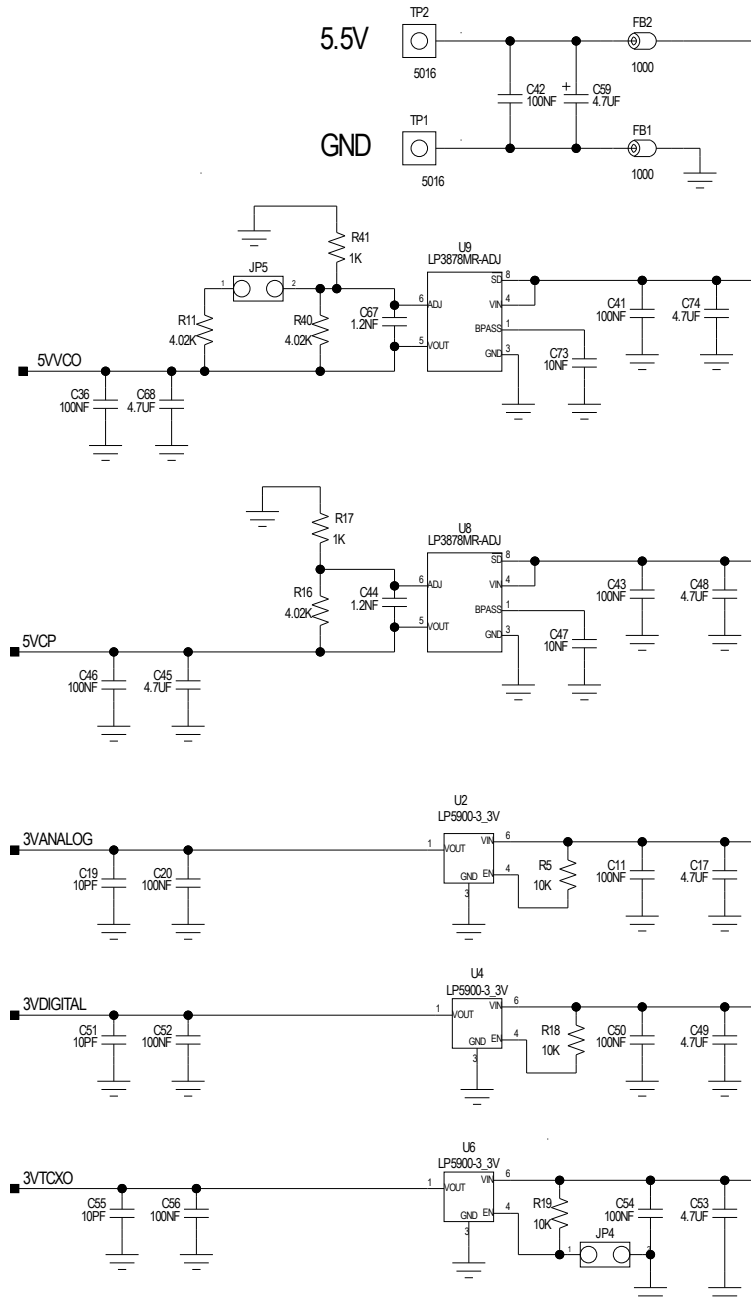

7

PLLS w/ INTEGRATED VCO - SMT



**FRACTIONAL-N PLL WITH
INTEGRATED VCO, 7.8 - 8.8 GHz**

Absolute Maximum Ratings

Nominal 3.3V Supplies to GND	-0.3V to +3.6V
Nominal Digital Supply Relative to 3.3V Analog Supply	-0.3V to +0.3V
Nominal 5V Supply to GND	-0.3 to +5.5V
Vtune	0 to +15V
Storage Temperature	-65 to +150°C
Max Peak Reflow Temperature	260 °C
ESD Sensitivity (HBM)	Class 1A

Reliability Information

Junction Temperature to Maintain 1 Million Hour MTTF	135 °C
Nominal Junction Temperature (T=85 °C)	132 °C
Thermal Resistance (Junction to GND Paddle, 5V Supply)	38.4 °C/W
Operating Temperature	-40 to +85°C

Outline Drawing

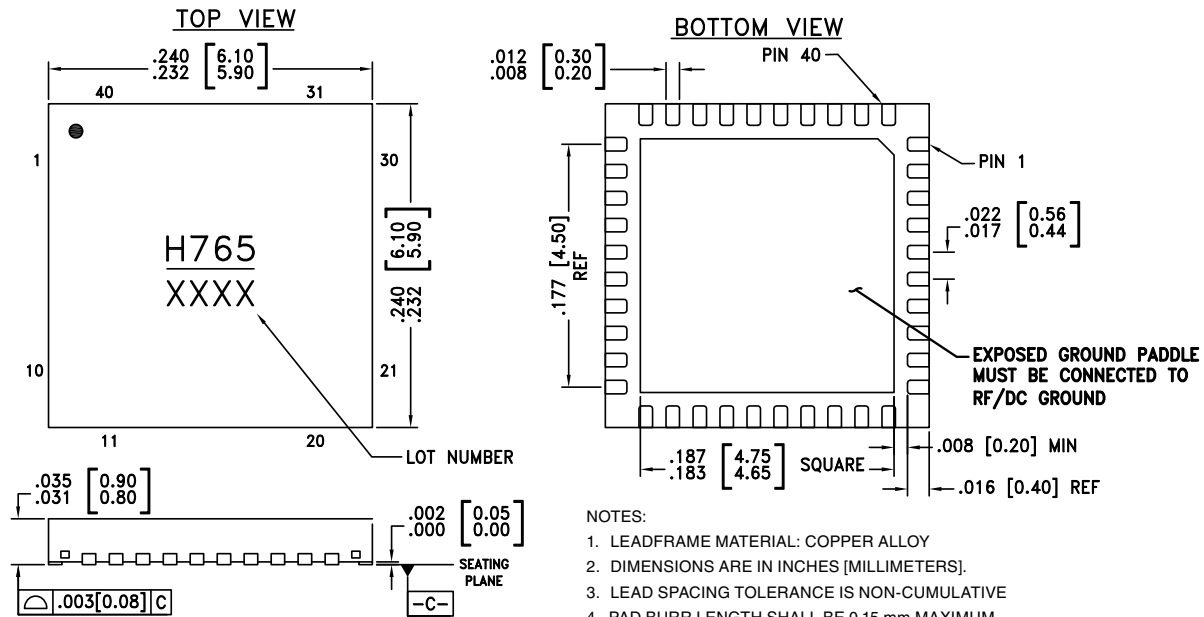

- NOTES:
- LEADFRAME MATERIAL: COPPER ALLOY
 - DIMENSIONS ARE IN INCHES [MILLIMETERS].
 - LEAD SPACING TOLERANCE IS NON-CUMULATIVE
 - PAD BURR LENGTH SHALL BE 0.15 mm MAXIMUM. PAD BURR HEIGHT SHALL BE 0.05 mm MAXIMUM.
 - PACKAGE WARP SHALL NOT EXCEED 0.05 mm.
 - ALL GROUND LEADS AND GROUND PADDLE MUST BE SOLDERED TO PCB RF GROUND.
 - REFER TO HITTITE APPLICATION NOTE FOR SUGGESTED PCB LAND PATTERN.

Package Information

Part Number	Package Body Material	Lead Finish	MSL Rating	Package Marking ^[1]
HMC765LP6CE	RoHS-compliant Low Stress Injection Molded Plastic	100% matte Sn	MSL3	H765 XXXX

[1] 4-Digit lot number XXXX



**FRACTIONAL-N PLL WITH
INTEGRATED VCO, 7.8 - 8.8 GHz**

Evaluation PCB

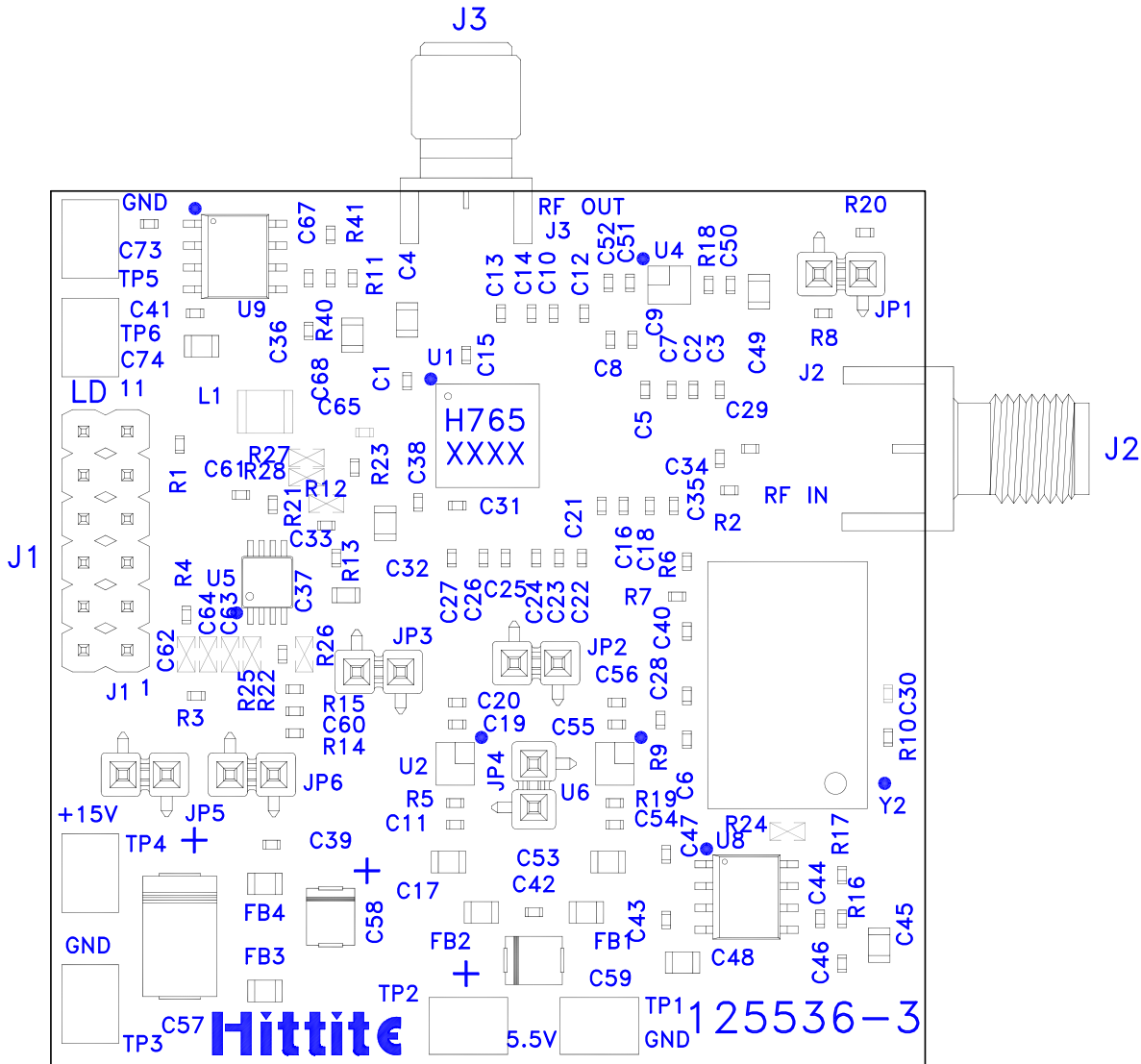

The circuit board used in the application should use RF circuit design techniques. Signal lines should have 50 Ohm impedance while the package ground leads and exposed paddle should be connected directly to the ground plane similar to that shown. A sufficient number of via holes should be used to connect the top and bottom ground planes. The evaluation circuit board shown is available from Hittite upon request.



FRACTIONAL-N PLL WITH INTEGRATED VCO, 7.8 - 8.8 GHz

List of Materials for Evaluation PCB 127270 [1]

Item	Description
J1	Dual Row Terminal Strip
J2, J3	PCB Mount SMA RF Connector
JP1 - JP6	Single Row Terminal Strip
C1, C21, C38 - C39, C60	1000 pF Capacitor, 0402 Pkg.
C2, C5, C6, C8, C10, C13, C16, C19, C22, C24, C26, C51, C55	10 pF Capacitor, 0402 Pkg.
C3, C7, C9, C11, C12, C14, C18, C20, C23, C25, C27 - C29, C34 - C36, C40 - C43, C46, C50, C52, C54, C56	0.1 μ F Capacitor, 0402 Pkg.
C4, C17, C32, C45, C48, C49, C53, C68, C74	4.7 μ F Capacitor, 0805 Pkg.
C15, C31	100 pF Capacitor, 0402 Pkg.
C33	1800 pF Capacitor, 0402 Pkg.
C37	0.056 μ F Capacitor, 0603 Pkg.
C44, C67	1200 pF Capacitor, 0402 Pkg.
C47, C73	10,000 pF Capacitor, 0402 Pkg.
C57	22 μ F Tantalum Capacitor, Case D
C58, C59	4.7 μ F Tantalum Capacitor, Case B
C61	3900 pF Capacitor, 0402 Pkg.
FB1 - FB4	1000 Ohm 200 mA Ferrite Chip, 0805 Pkg.
R1, R8	100k Ohm Resistor, 0402 Pkg.
R2, R7	120 Ohm Resistor, 0402 Pkg.
R3, R17, R20, R41	1k Ohm Resistor, 0402 Pkg.
R4	620 Ohm Resistor, 0402 Pkg.
R5, R14, R15, R18, R19	10k Ohm Resistor, 0402 Pkg.
R6	56 Ohm Resistor, 0402 Pkg.
R9	10 Ohm Resistor, 0402 Pkg.
R10, R22, R23	Zero Ohm Resistor, 0402 Pkg.
R11, R16, R40	4.02k Ohm Resistor, 0402 Pkg.
R13	130 Ohm Resistor, 0402 Pkg.
R21	30 Ohm Resistor, 0402 Pkg.
TP1 - TP6	Test Point PC Compact SMT
U1	HMC765LP6CE Fractional-N PLL, with Integrated VCO
U2, U4, U6	Low Noise 3.3V, 100 mA Linear Regulator
U5	Low Noise Op-Amp, THS4031IDGN
U8, U9	5V, 800mA Voltage Regulator
Y2	3.3V, 50 MHz VCXO Crystal Oscillator
PCB [2]	125536 Evaluation Board

[1] Reference this number when ordering complete evaluation PCB

[2] Circuit Board Material: Rogers 4350 or Arlon 25FR and FR4