

DRV421 Integrated Magnetic Fluxgate Sensor for Closed-Loop Current Sensing

1 Features

- High-Precision Integrated Fluxgate Sensor
 - Offset and Drift: $\pm 8 \mu\text{T}$ max, $\pm 5 \text{ nT}/^\circ\text{C}$ typ
- Extended Current Measurement Range
 - H-Bridge Output Drive: $\pm 250 \text{ mA}$ typ at 5 V
- Precision Shunt Sense Amplifier
 - Offset and Drift (max): $\pm 75 \mu\text{V}$, $\pm 2 \mu\text{V}/^\circ\text{C}$
 - Gain Error and Drift (max): $\pm 0.3\%$, $\pm 5 \text{ ppm}/^\circ\text{C}$
- Precision Reference
 - Accuracy and Drift (max): $\pm 2\%$, $\pm 50 \text{ ppm}/^\circ\text{C}$
 - Pin-Selectable Voltage: 2.5 V or 1.65 V
 - Selectable Ratiometric Mode: $V_{\text{DD}} / 2$
- Magnetic Core Degaussing Feature
- Diagnostic Features: Overrange and Error Flags
- Supply Voltage Range: 3.0 V to 5.5 V
- Fully Specified Over the Extended Industrial Temperature Range of -40°C to $+125^\circ\text{C}$

2 Applications

- Closed-Loop DC- and AC-Current Sensor Modules
- Leakage Current Sensors
- Industrial Monitoring and Control Systems
- Overcurrent Detection
- Frequency, Voltage, and Solar Inverters

3 Description

The DRV421 is designed for magnetic closed-loop current sensing solutions, enabling isolated, precise dc- and ac-current measurements. This device provides both, a proprietary integrated fluxgate sensor, and the required analog signal conditioning, thus minimizing component count and cost. The low offset and drift of the fluxgate sensor, along with an optimized front-end circuit results in unrivaled measurement precision.

The DRV421 provides all the necessary circuit blocks to drive the current-sensing feedback loop. The sensor front-end circuit is followed by a filter that can be configured to work with a wide range of magnetic cores. The integrated 250-mA H-Bridge drives the compensation coil and doubles the current measurement range, as compared to conventional single-ended drive methods. The device also provides a precision voltage reference and shunt sense amplifier to generate and drive the analog output signal.

Device Information⁽¹⁾

PART NUMBER	PACKAGE	BODY SIZE (NOM)
DRV421	WQFN (20)	4.00 mm x 4.00 mm

(1) For all available packages, see the package option addendum at the end of the datasheet.

Typical Application

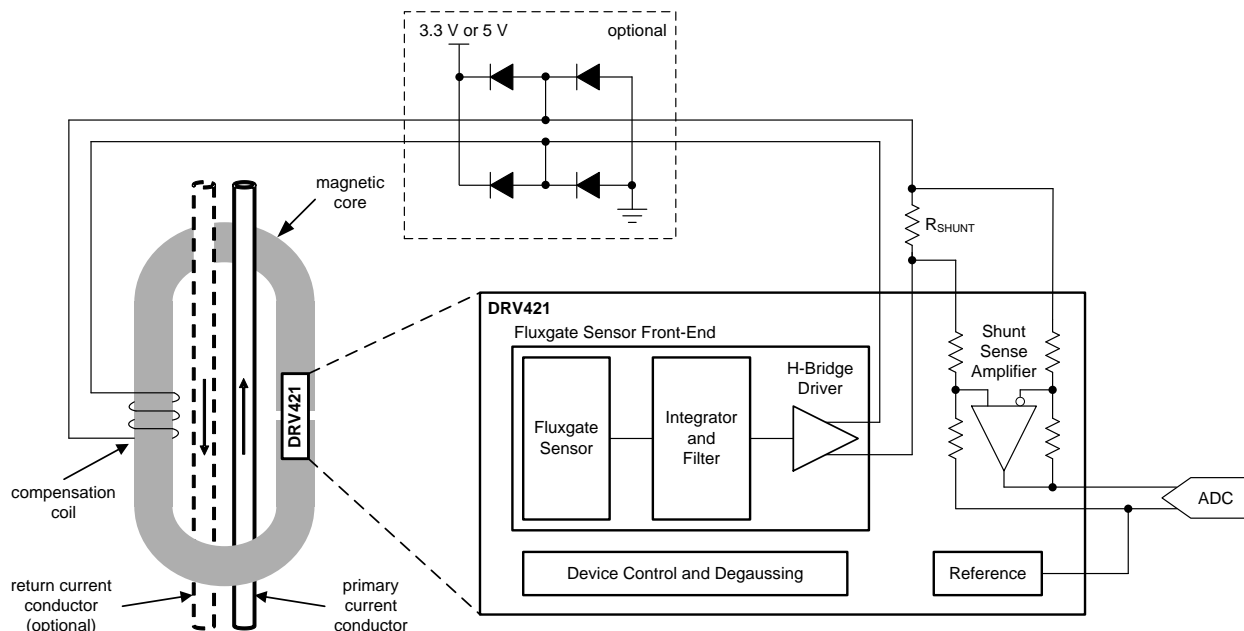

Table of Contents

1 Features	1	8 Application and Implementation	27
2 Applications	1	8.1 Application Information.....	27
3 Description	1	8.2 Typical Application	29
4 Revision History	2	9 Power-Supply Recommendations	34
5 Pin Configuration and Functions	3	9.1 Power-Supply Decoupling.....	34
6 Specifications	4	9.2 Power-On Start Up and Brownout	34
6.1 Absolute Maximum Ratings	4	9.3 Power Dissipation	34
6.2 ESD Ratings.....	4	10 Layout	35
6.3 Recommended Operating Conditions.....	4	10.1 Layout Guidelines	35
6.4 Thermal Information	4	10.2 Layout Example	36
6.5 Electrical Characteristics.....	5	11 Device and Documentation Support	37
6.6 Typical Characteristics.....	7	11.1 Documentation Support	37
7 Detailed Description	16	11.2 Community Resources.....	37
7.1 Overview	16	11.3 Trademarks	37
7.2 Functional Block Diagram	16	11.4 Electrostatic Discharge Caution.....	37
7.3 Feature Description.....	17	11.5 Glossary	37
7.4 Device Functional Modes.....	26	12 Mechanical, Packaging, and Orderable Information	37

4 Revision History

NOTE: Page numbers for previous revisions may differ from page numbers in the current version.

Changes from Revision A (July 2015) to Revision B	Page
• Added TI Design	1
• Added last two <i>Applications</i> bullets	1
• Changed QFN to WQFN in pin configuration drawing	3
• Changed QFN to WQFN in <i>Thermal Information</i> table	4
• Changed QFN to WQFN in <i>Power Dissipation</i> section	34

Changes from Original (May 2015) to Revision A	Page
• Released to production.....	1

5 Pin Configuration and Functions

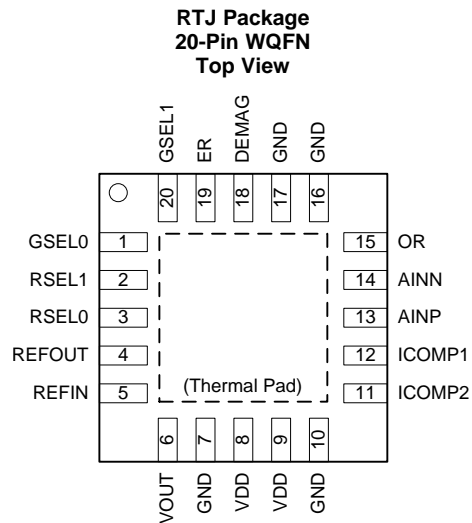

Pin Functions

PIN		I/O	DESCRIPTION
NAME	NO.		
AINN	14	I	Inverting input of shunt sense amplifier
AINP	13	I	Noninverting input of shunt sense amplifier
DEMAG	18	I	Degauss control input
ER	19	O	Error flag; open-drain, active low output
GND	7, 10, 16, 17	—	Ground reference
GSEL0	1	I	Gain and bandwidth selection input 0
GSEL1	20	I	Gain and bandwidth selection input 1
ICOMP1	12	O	Output 1 of compensation coil driver
ICOMP2	11	O	Output 2 of compensation coil driver
OR	15	O	Shunt sense amplifier overrange indicator; open-drain, active-low output
REFIN	5	I	Common-mode reference input for the shunt sense amplifier
REFOUT	4	O	Voltage reference output
RSEL0	3	I	Voltage reference mode selection input 0
RSEL1	2	I	Voltage reference mode selection input 1
VDD	8, 9	—	Supply voltage, 3.0 V to 5.5 V. Decouple both pins using 1- μ F ceramic capacitors placed as close as possible to the device. See the Power-Supply Decoupling and Layout sections for further details.
VOUT	6	O	Shunt sense amplifier output
PowerPAD™		—	Connect thermal pad to GND

6 Specifications

6.1 Absolute Maximum Ratings

 over operating free-air temperature range (unless otherwise noted) ⁽¹⁾

		MIN	MAX	UNIT	
Voltage	Supply voltage (VDD to GND)	-0.3	7	V	
	Input voltage, except pins AINP and AINN ⁽²⁾	GND - 0.5	V _{DD} + 0.5		
	Shunt sense amplifier inputs (pins AINP and AINN) ⁽³⁾	GND - 6.0	V _{DD} + 6.0		
Current	Pins ICOMP1 and ICOMP2 (short circuit current I _{SC}) ⁽⁴⁾		-300	300	mA
	Shunt sense amplifier inputs	pins AINP and AINN	-5	5	
		All remaining pins	-25	25	
Temperature	Junction, T _J max	-50	150	°C	
	Storage, T _{stg}	-65	150		

- (1) Stresses beyond those listed under *Absolute Maximum Ratings* may cause permanent damage to the device. These are stress ratings only, which do not imply functional operation of the device at these or any other conditions beyond those indicated under *Recommended Operating Conditions*. Exposure to absolute-maximum-rated conditions for extended periods may affect device reliability.
- (2) Input terminals are diode-clamped to the power-supply rails. Input signals that can swing more than 0.5 V beyond the supply rails must be current limited, except for the shunt sense amplifier input pins.
- (3) These inputs are not diode-clamped to the power supply rails.
- (4) Power-limited; observe maximum junction temperature.

6.2 ESD Ratings

		VALUE	UNIT
V _(ESD) Electrostatic discharge	Human-body model (HBM), per ANSI/ESDA/JEDEC JS-001 ⁽¹⁾	±2000	V
	Charged-device model (CDM), per JEDEC specification JESD22-C101 ⁽²⁾	±1000	

- (1) JEDEC document JEP155 states that 500-V HBM allows safe manufacturing with a standard ESD control process.
- (2) JEDEC document JEP157 states that 250-V CDM allows safe manufacturing with a standard ESD control process.

6.3 Recommended Operating Conditions

over operating free-air temperature range (unless otherwise noted)

		MIN	NOM	MAX	UNIT
V _{DD}	Supply voltage	3.0	5.0	5.5	V
T _A	Specified ambient temperature range	-40		125	°C

6.4 Thermal Information

THERMAL METRIC ⁽¹⁾		SBOS704	UNITS
		RTJ (WQFN)	
		20 PINS	
R _{θJA}	Junction-to-ambient thermal resistance	34.1	°C/W
R _{θJC(top)}	Junction-to-case (top) thermal resistance	33.1	°C/W
R _{θJB}	Junction-to-board thermal resistance	11.0	°C/W
ψ _{JT}	Junction-to-top characterization parameter	0.3	°C/W
ψ _{JB}	Junction-to-board characterization parameter	11.0	°C/W
R _{θJC(bot)}	Junction-to-case (bottom) thermal resistance	2.1	°C/W

- (1) For more information about traditional and new thermal metrics, see the *Semiconductor and IC Package Thermal Metrics* application report, [SPRA953](#).

6.5 Electrical Characteristics

All minimum and maximum specifications at $T_A = +25^\circ\text{C}$, $V_{DD} = 3.0\text{ V to }5.5\text{ V}$, and $I_{COMP1} = I_{COMP2} = 0\text{ mA}$ (unless otherwise noted). Typical values are at $V_{DD} = 5.0\text{ V}$.

PARAMETER		TEST CONDITIONS	MIN	TYP	MAX	UNIT
FLUXGATE SENSOR FRONT-END						
	Offset ⁽¹⁾	No magnetic field	-8	±2	8	μT
	Offset drift	No magnetic field		±5		nT/°C
	Noise	f = 0.1 Hz to 10 Hz		17		nTrms
	Noise density	f = 1 kHz		1.5		nT/√Hz
	Saturation trip level for pin ER			1.7		mT
A _{OL}	DC open-loop gain			16		V/μT
	AC open-loop gain	GSEL[1:0] = 00, at 3.8 kHz, integration-to-flatband corner frequency		8.5		V/mT
		GSEL[1:0] = 01, at 3.8 kHz, integration-to-flatband corner frequency		38		
		GSEL[1:0] = 10, at 1.9 kHz, integration-to-flatband corner frequency		25		
		GSEL[1:0] = 11, at 1.9 kHz, integration-to-flatband corner frequency		70		
I _{ICOMP}	Peak current at pins ICOMP1 and ICOMP2	V _{ICOMP1} - V _{ICOMP2} = 4.2 V _{PP} , V _{DD} = 5 V, T _A = -40°C to +125°C	210	250		mA
		V _{ICOMP1} - V _{ICOMP2} = 2.5 V _{PP} , V _{DD} = 3.3 V, T _A = -40°C to +125°C	125	150		
V _{ICOMP}	Voltage swing at pins ICOMP1 and ICOMP2	20-Ω load, V _{DD} = 5 V, T _A = -40°C to +125°C	4.2			V _{PP}
		20-Ω load, V _{DD} = 3.3 V, T _A = -40°C to +125°C	2.5			
	Common-mode output voltage at pins ICOMP1 and ICOMP2			V _{REFOUT}		V
SHUNT SENSE AMPLIFIER						
V _{OO}	Output offset voltage	V _{AINP} = V _{AINN} = V _{REFIN} , V _{DD} = 3.0 V	-0.075	±0.01	0.075	mV
	Output offset voltage drift		-2	±0.4	2	μV/°C
CMRR	Common-mode rejection ratio, RTO ⁽²⁾	V _{CM} = -1 V to V _{DD} + 1 V, V _{REFIN} = V _{DD} / 2	-250	±50	250	μV/V
PSRR _{AMP}	Power-supply rejection ratio, RTO	V _{DD} = 3.0 V to 5.5 V, V _{CM} = V _{REFIN}	-50	±4	50	μV/V
V _{IC}	Common-mode input voltage range		-1		V _{DD} + 1	V
Z _{IND}	Differential input impedance		16.5	20	23.5	kΩ
Z _{IC}	Common-mode input impedance		40	50	60	kΩ
G	Gain, V _{OUT} / (V _{AINP} - V _{AINN})			4		V/V
E _G	Gain error		-0.3%	±0.02%	0.3%	
	Gain error drift		-5	±1	5	ppm/°C
	Linearity error	R _L = 1 kΩ		12		ppm
	Voltage output swing from negative rail (OR pin trip level)	V _{DD} = 5.5 V, I _{VOUT} = 2.5 mA		48	85	mV
		V _{DD} = 3.0 V, I _{VOUT} = 2.5 mA		56	100	
	Voltage output swing from positive rail (OR pin trip level)	V _{DD} = 5.5 V, I _{VOUT} = -2.5 mA	V _{DD} - 85	V _{DD} - 48		mV
		V _{DD} = 3.0 V, I _{VOUT} = -2.5 mA	V _{DD} - 100	V _{DD} - 56		
I _{SC}	Short-circuit current	V _{OUT} connected to GND		-18		mA
		V _{OUT} connected to VDD		20		
	Signal overrange indication delay (OR pin)	V _{IN} = 1-V step		2.5 to 3.5		μs
BW _{-3dB}	Bandwidth			2		MHz
SR	Slew rate			6.5		V/μs
	Settling time, large-signal	ΔV = ± 2 V to 1% accuracy, no external filter		0.9		μs
	Settling time, small-signal	ΔV = ± 0.4 V to 0.01% accuracy		8		μs
e _n	Output voltage noise density, RTO	f = 1 kHz, compensation loop disabled		170		nV/√Hz
V _{REFIN}	Input voltage range at pin REFIN	T _A = -40°C to +125°C	GND		VDD	V

(1) Fluxgate sensor front-end offset can be reduced using the feature.

(2) Parameter value referred to output (RTO).

Electrical Characteristics (continued)

All minimum and maximum specifications at $T_A = +25^\circ\text{C}$, $V_{DD} = 3.0\text{ V to }5.5\text{ V}$, and $I_{COMP1} = I_{COMP2} = 0\text{ mA}$ (unless otherwise noted). Typical values are at $V_{DD} = 5.0\text{ V}$.

PARAMETER		TEST CONDITIONS	MIN	TYP	MAX	UNIT
VOLTAGE REFERENCE						
V_{REFOUT}	Reference output voltage at pin REFOUT	RSEL[1:0] = 00, no load	2.45	2.5	2.55	V
		RSEL[1:0] = 01, no load	1.6	1.65	1.7	
		RSEL[1:0] = 1x, no load	45	50	55	% of VDD
	Reference output voltage drift	RSEL[1:0] = 00, 01	-50	±10	50	ppm/°C
	Voltage divider gain error drift	RSEL[1:0] = 1x	-50	±10	50	ppm/°C
$PSRR_{REF}$	Power-supply rejection ratio	RSEL[1:0] = 00, 01	-300	±15	300	µV/V
	Load regulation	RSEL[1:0] = 0x, load to GND or VDD, $\Delta I_{LOAD} = 0\text{ mA to }5\text{ mA}$, $T_A = -40^\circ\text{C to }+125^\circ\text{C}$		0.15	0.35	mV/mA
		RSEL[1:0] = 1x, load to GND or VDD, $\Delta I_{LOAD} = 0\text{ mA to }5\text{ mA}$, $T_A = -40^\circ\text{C to }+125^\circ\text{C}$		0.3	0.8	
I_{SC}	Short-circuit current	REFOUT connected to VDD		20		mA
		REFOUT connected to GND		-18		
DIGITAL INPUTS/OUTPUTS						
Logic Inputs (CMOS)						
V_{IH}	High-level input voltage	$T_A = -40^\circ\text{C to }+125^\circ\text{C}$	$0.7 \times V_{DD}$		$V_{DD} + 0.3$	V
V_{IL}	Low-level input voltage	$T_A = -40^\circ\text{C to }+125^\circ\text{C}$	-0.3		$0.3 \times V_{DD}$	V
	Input leakage current			0.01		µA
Logic Outputs (Open-Drain)						
V_{OH}	High-level output voltage		Set by external pull-up resistor			V
V_{OL}	Low-level output voltage	4-mA sink		0.3		V
POWER SUPPLY						
I_Q	Quiescent current	$I_{COMP1} = I_{COMP2} = 0\text{ mA}$, $3.0\text{ V} \leq V_{DD} \leq 3.6\text{ V}$, $T_A = -40^\circ\text{C to }+125^\circ\text{C}$		6.5	9	mA
		$I_{COMP1} = I_{COMP2} = 0\text{ mA}$, $4.5\text{ V} \leq V_{DD} \leq 5.5\text{ V}$, $T_A = -40^\circ\text{C to }+125^\circ\text{C}$		8.1	11	
V_{RST}	Power-on reset threshold			2.4		V

6.6 Typical Characteristics

at $V_{DD} = 5\text{ V}$ and $T_A = +25^\circ\text{C}$ (unless otherwise noted)

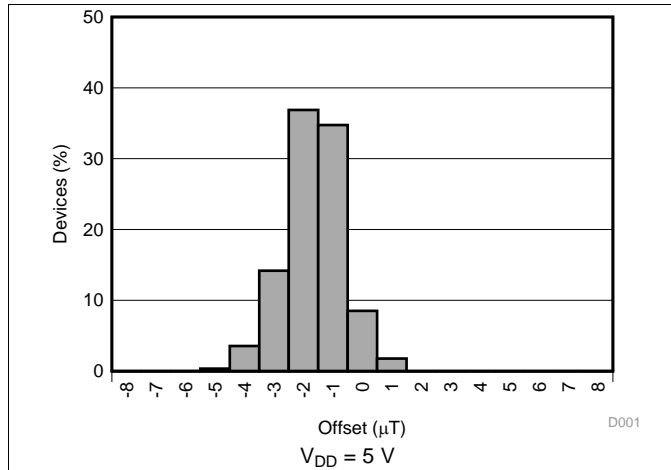

Figure 1. Fluxgate Sensor Front-End Offset Histogram

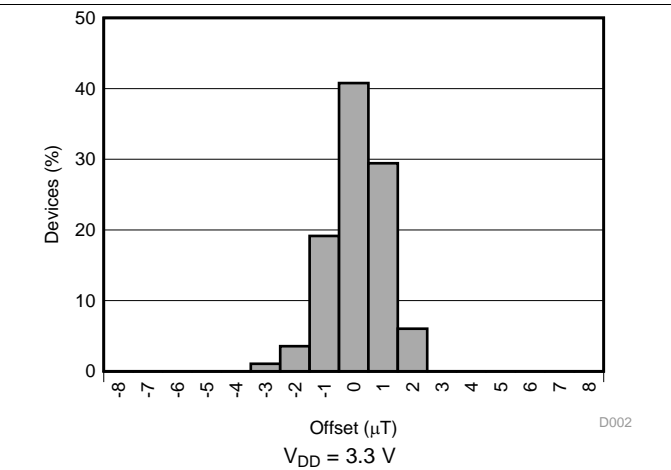

Figure 2. Fluxgate Sensor Front-End Offset Histogram

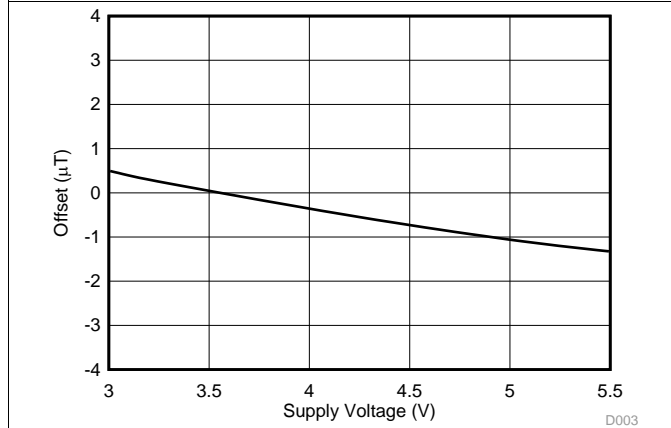

Figure 3. Fluxgate Sensor Front-End Offset vs Supply Voltage

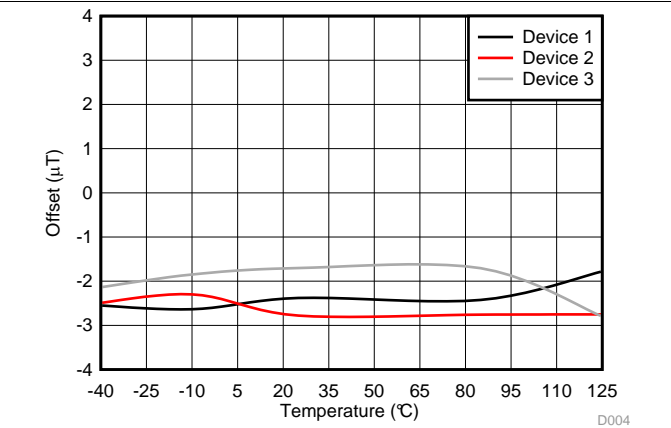

Figure 4. Fluxgate Sensor Front-End Offset vs Temperature

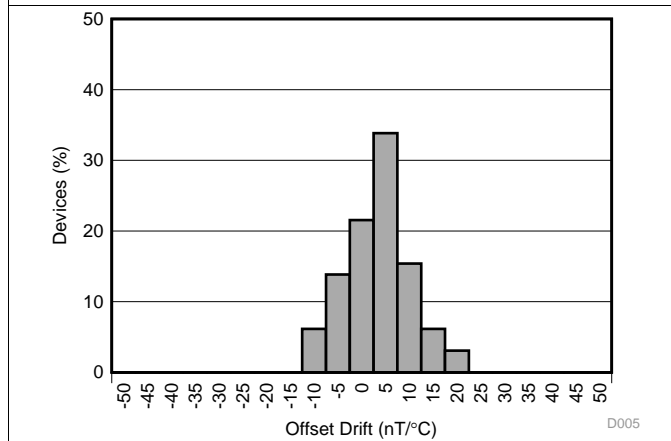

Figure 5. Fluxgate Sensor Front-End Offset Drift Histogram

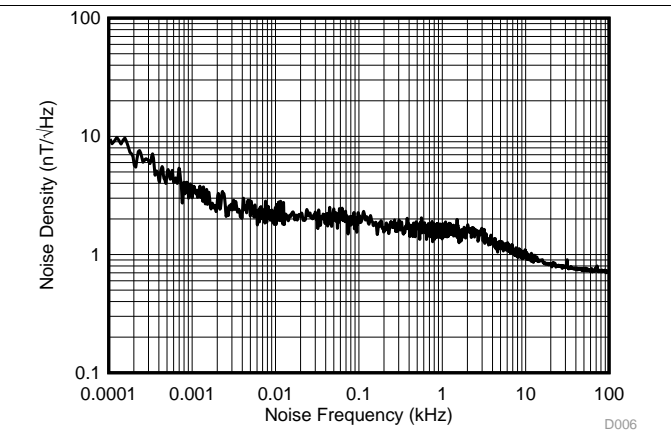

Figure 6. Fluxgate Sensor Front-End Noise Density vs Noise Frequency

Typical Characteristics (continued)

at $V_{DD} = 5\text{ V}$ and $T_A = +25^\circ\text{C}$ (unless otherwise noted)

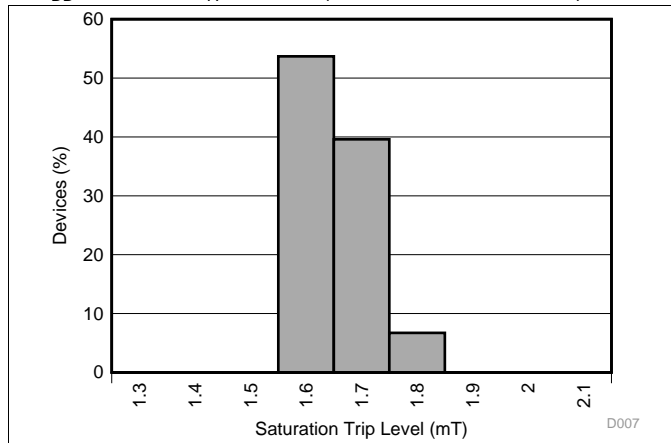

Figure 7. Fluxgate Sensor Saturation (ER Pin) Trip Level Histogram

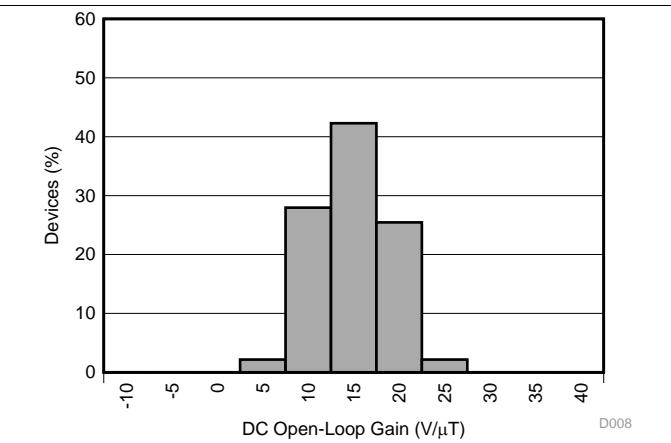

Figure 8. Fluxgate Sensor Front-End DC Open-Loop Gain Histogram

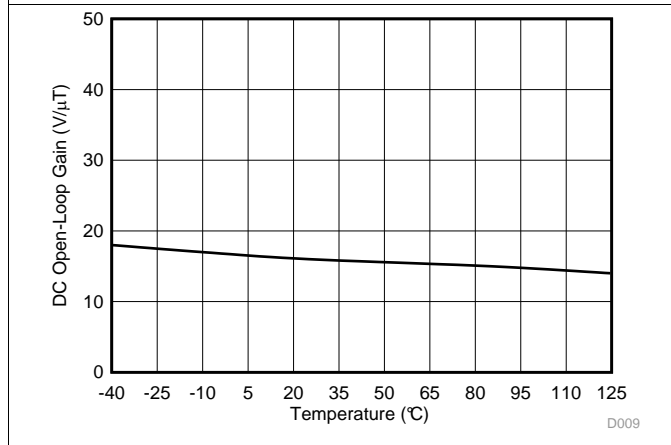

Figure 9. Fluxgate Sensor Front-End DC Open-Loop Gain vs Temperature

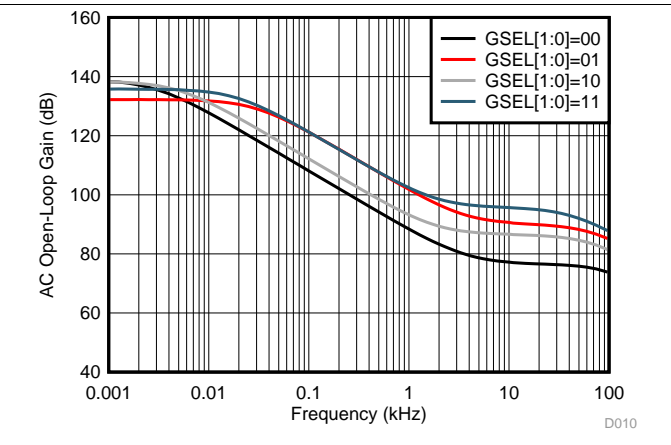

Figure 10. Fluxgate Sensor Front-End AC Open-Loop Gain vs Frequency

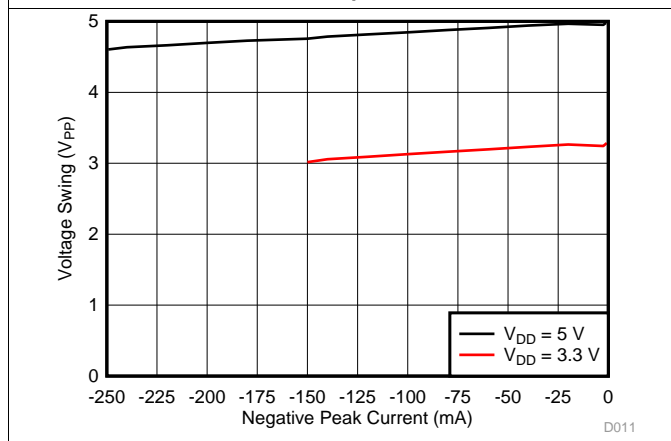

Figure 11. Voltage Swing at ICOMPx Pins vs Negative Peak Current

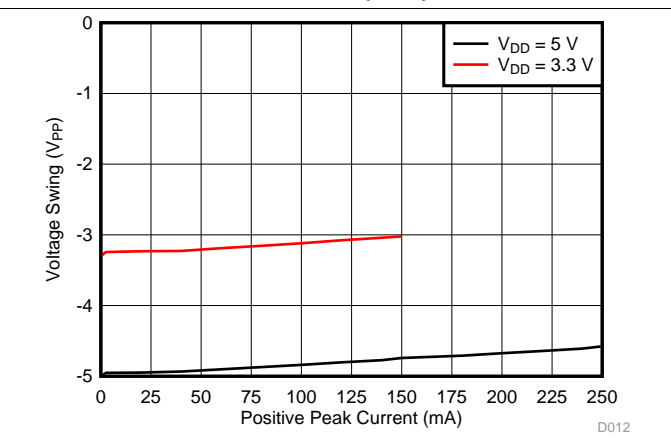
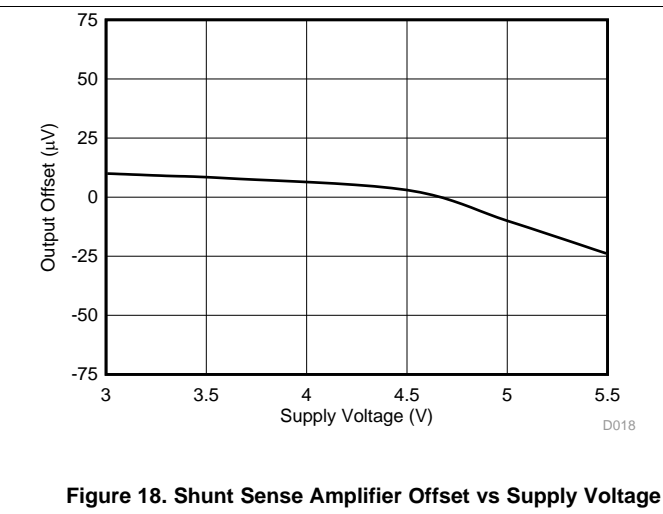
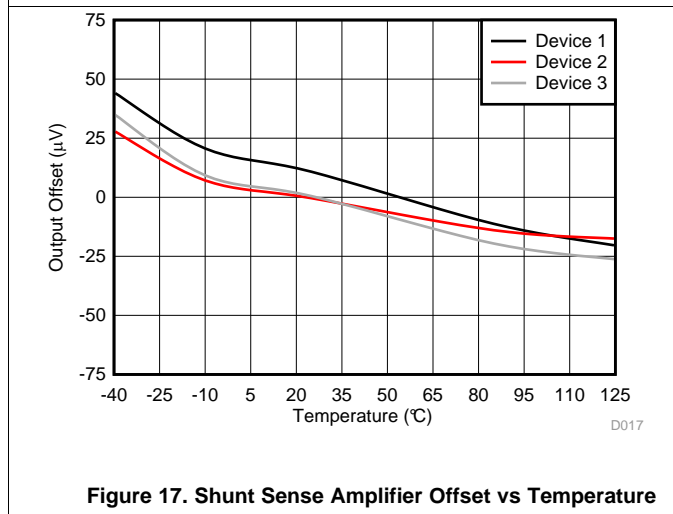
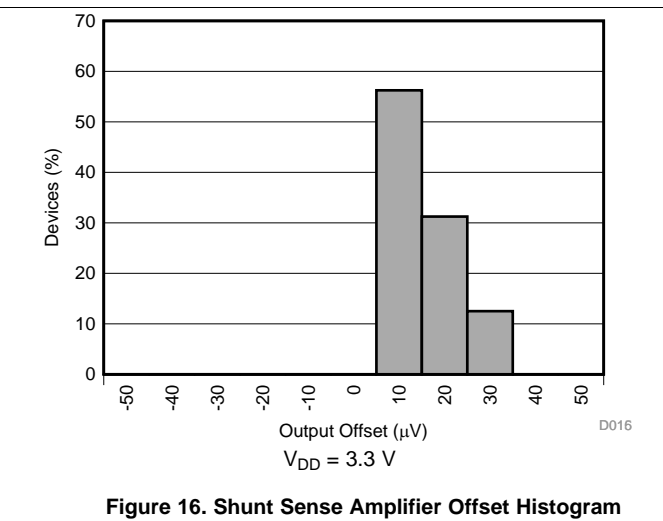
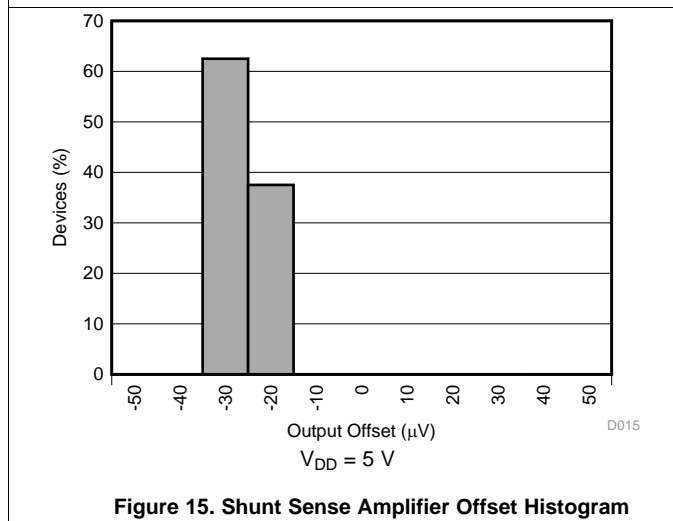
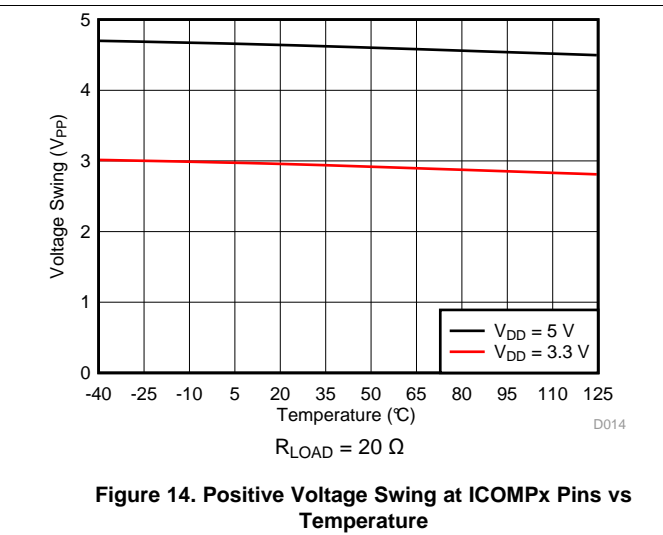
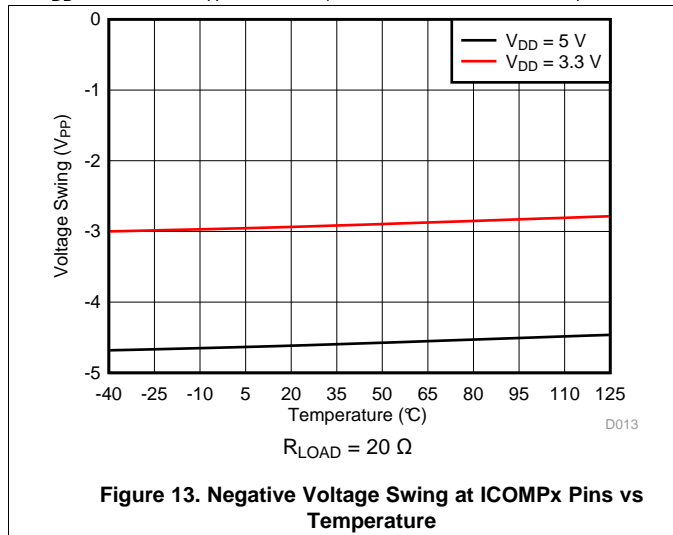

Figure 12. Voltage Swing at ICOMPx Pins vs Positive Peak Current

Typical Characteristics (continued)

at $V_{DD} = 5\text{ V}$ and $T_A = +25^\circ\text{C}$ (unless otherwise noted)



Typical Characteristics (continued)

at $V_{DD} = 5\text{ V}$ and $T_A = +25^\circ\text{C}$ (unless otherwise noted)

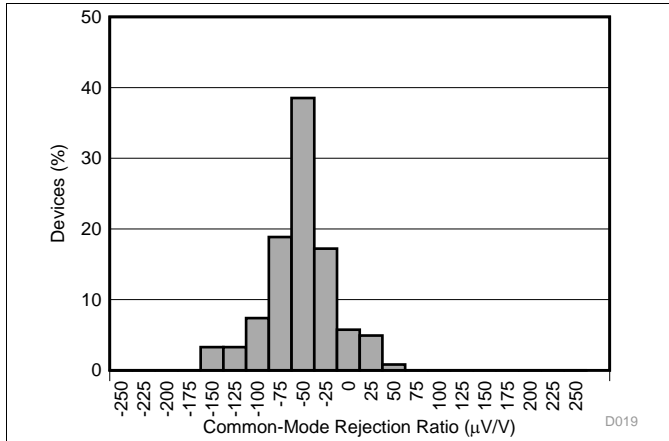

Figure 19. Shunt Sense Amplifier Common-Mode Rejection Ratio Histogram

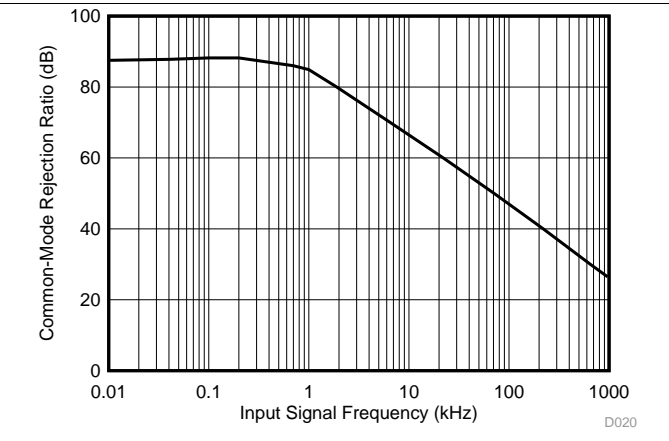

Figure 20. Shunt Sense Amplifier Common-Mode Rejection Ratio vs Input Signal Frequency

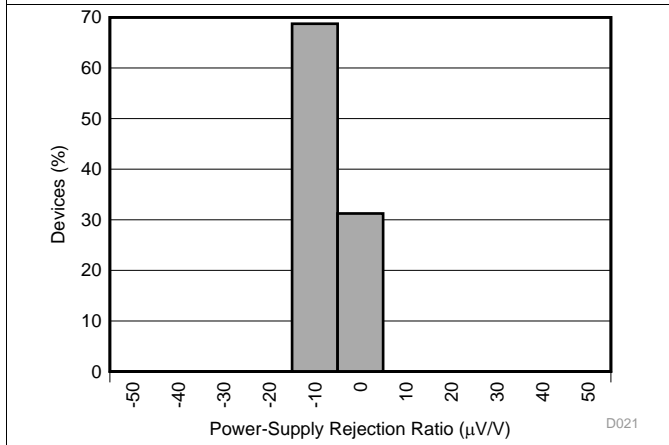

Figure 21. Shunt Sense Amplifier Power-Supply Rejection Ratio Histogram

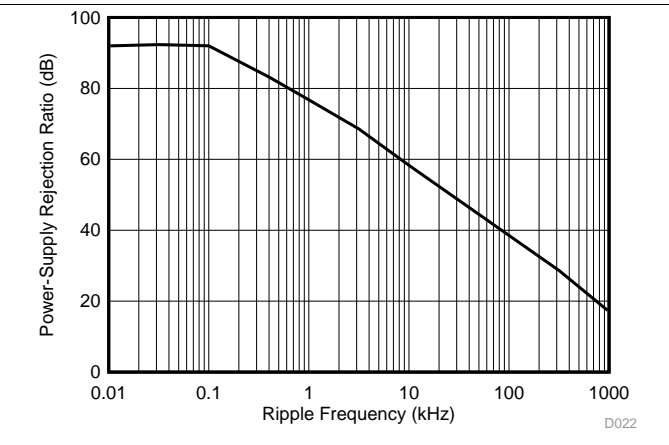

Figure 22. Shunt Sense Amplifier Power-Supply Rejection Ratio vs Ripple Frequency

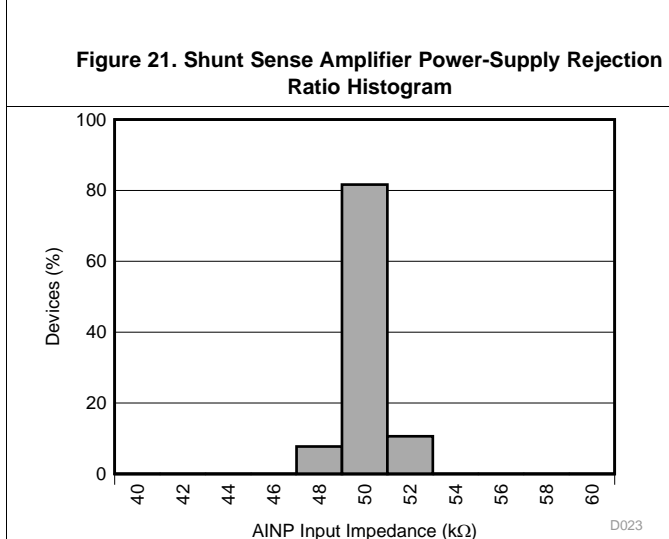

Figure 23. Shunt Sense Amplifier AINP Input Impedance Histogram

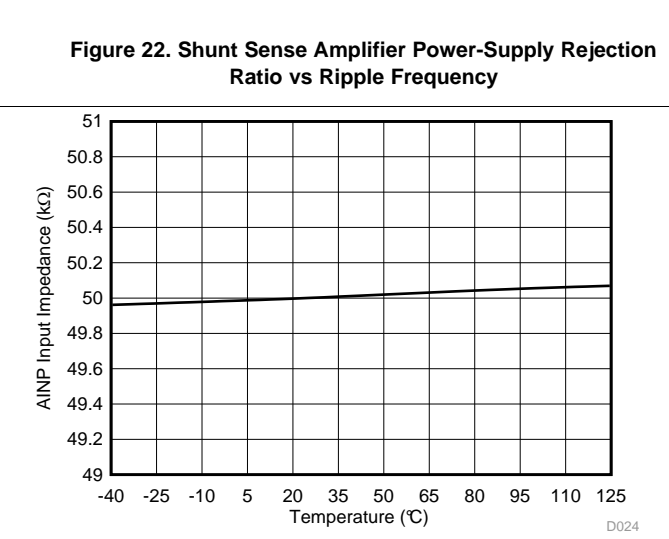

Figure 24. Shunt Sense Amplifier AINP Input Impedance vs Temperature

Typical Characteristics (continued)

at $V_{DD} = 5\text{ V}$ and $T_A = +25^\circ\text{C}$ (unless otherwise noted)

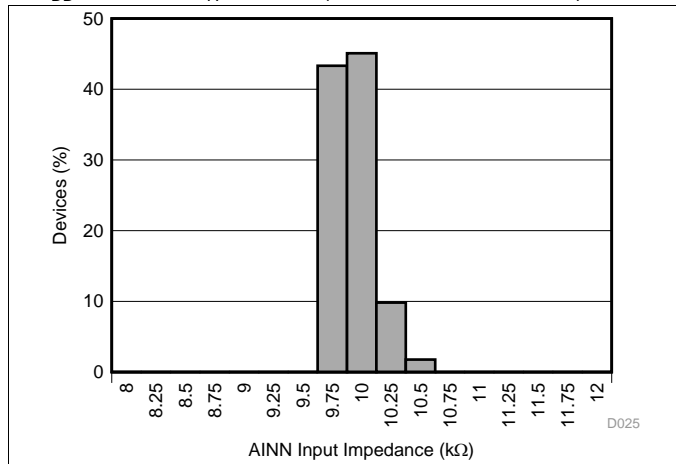

Figure 25. Shunt Sense Amplifier AINN Input Impedance Histogram

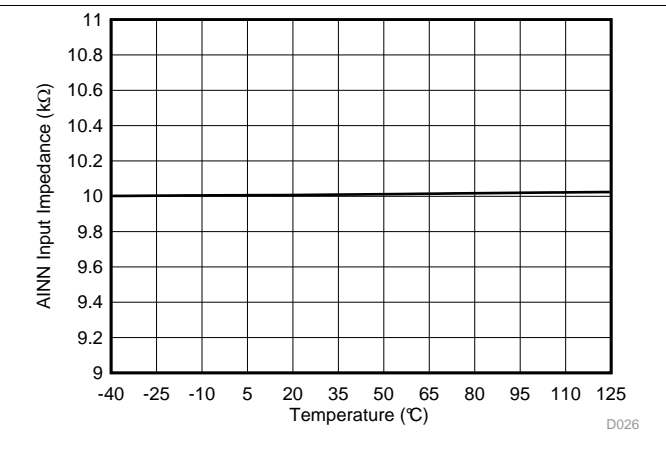

Figure 26. Shunt Sense Amplifier AINN Input Impedance vs Temperature

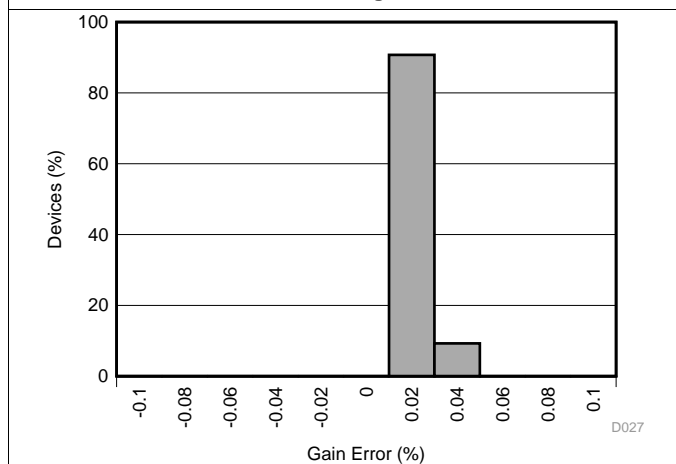

Figure 27. Shunt Sense Amplifier Gain Error Histogram

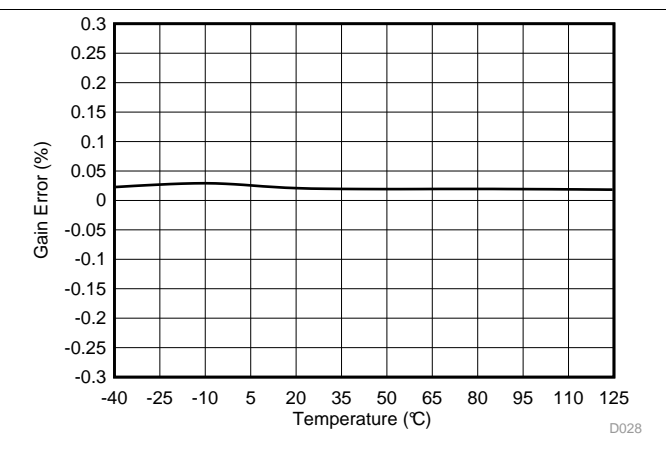

Figure 28. Shunt Sense Amplifier Gain Error vs Temperature

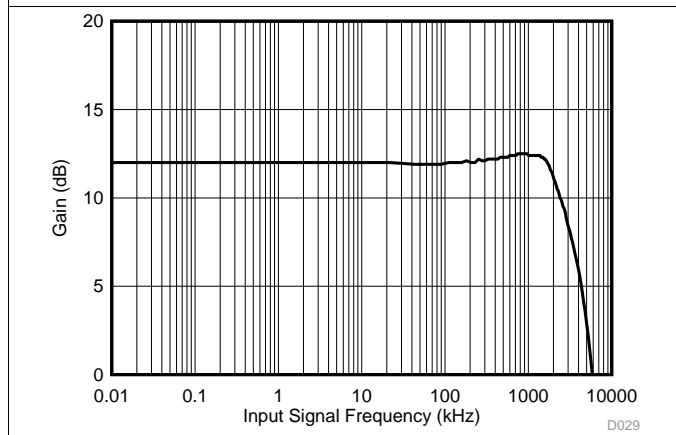

Figure 29. Shunt Sense Amplifier Gain vs Frequency

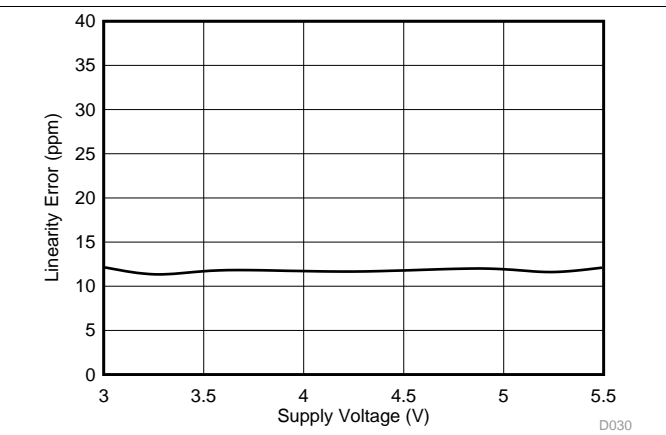
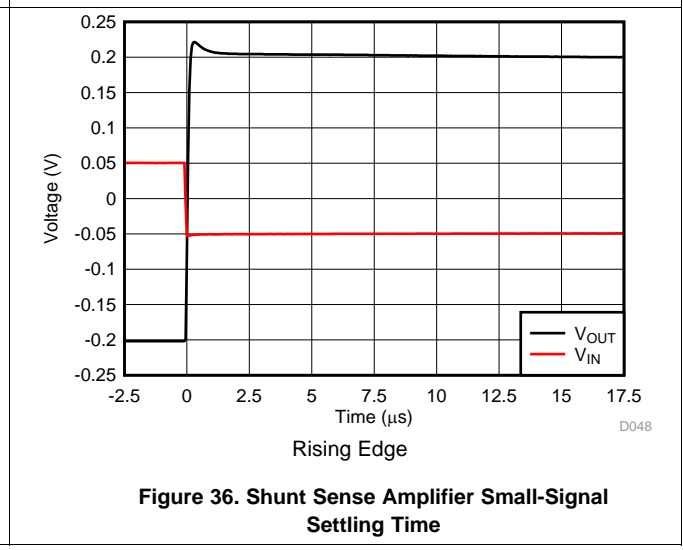
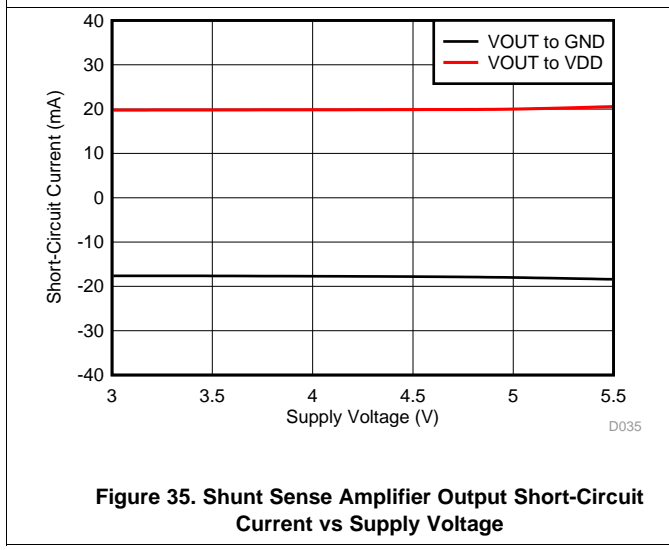
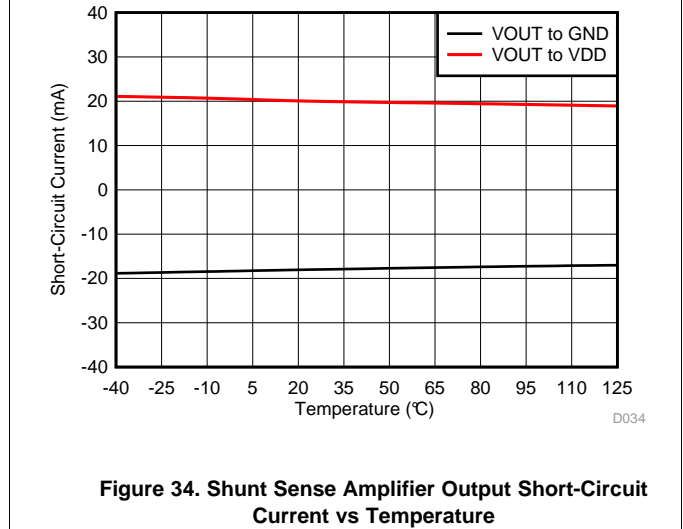
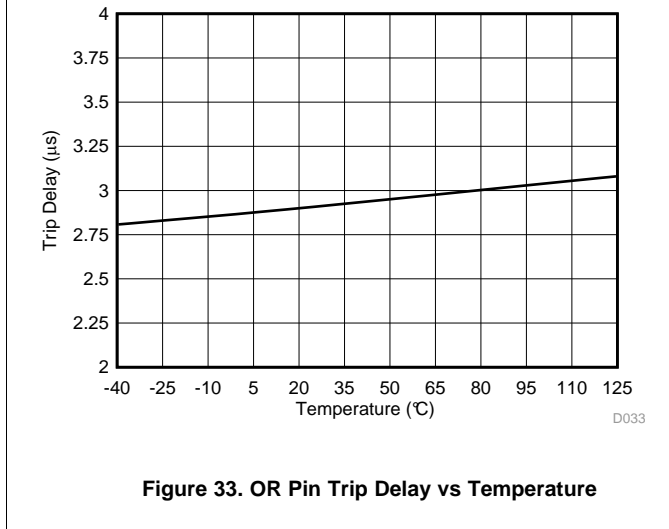
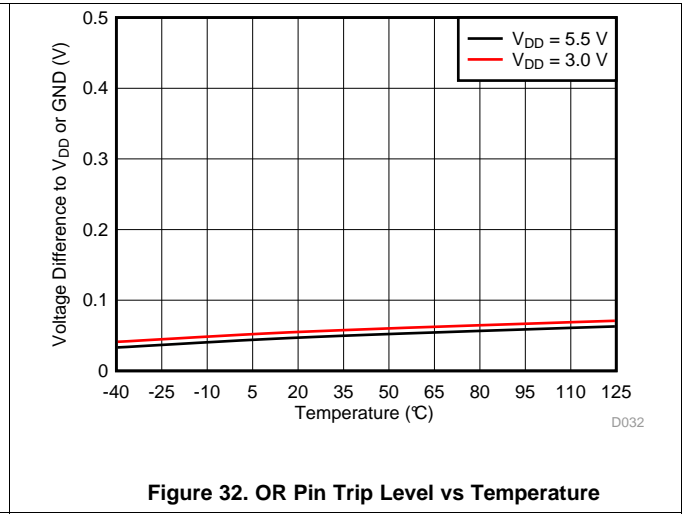
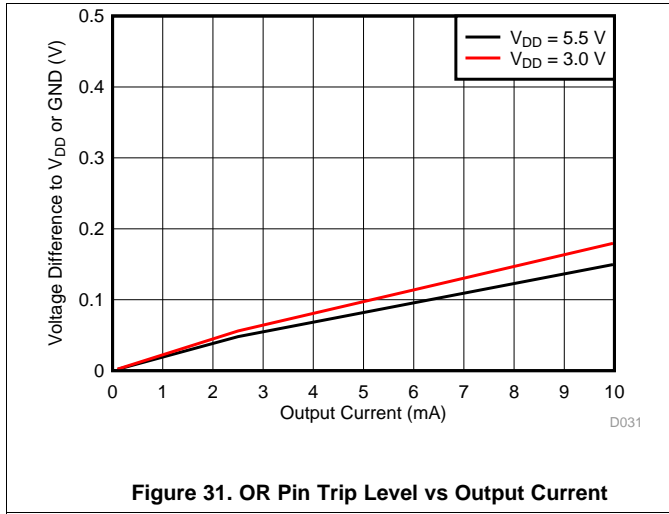

Figure 30. Shunt Sense Amplifier Linearity vs Supply Voltage

Typical Characteristics (continued)

at $V_{DD} = 5\text{ V}$ and $T_A = +25^\circ\text{C}$ (unless otherwise noted)



Typical Characteristics (continued)

at $V_{DD} = 5\text{ V}$ and $T_A = +25^\circ\text{C}$ (unless otherwise noted)

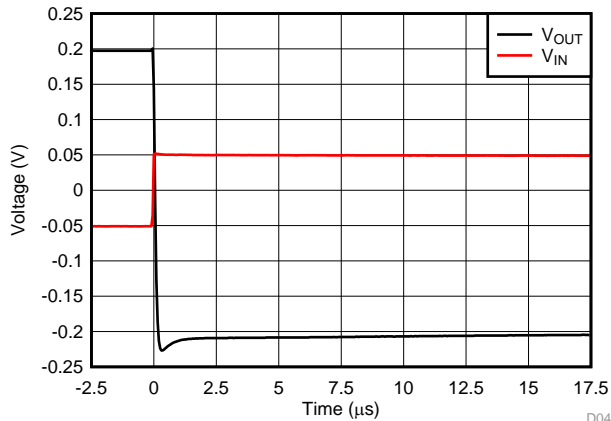

Figure 37. Shunt Sense Amplifier Small-Signal Settling Time

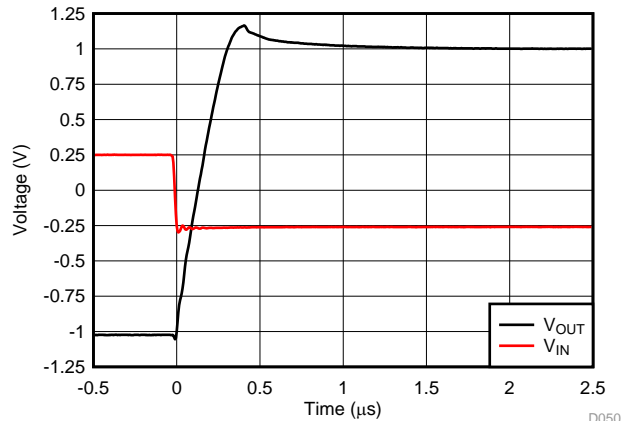

Figure 38. Shunt Sense Amplifier Large-Signal Settling Time

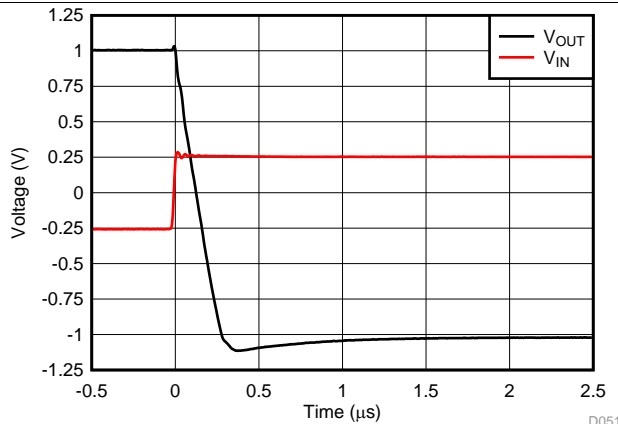

Figure 39. Shunt Sense Amplifier Large-Signal Settling Time

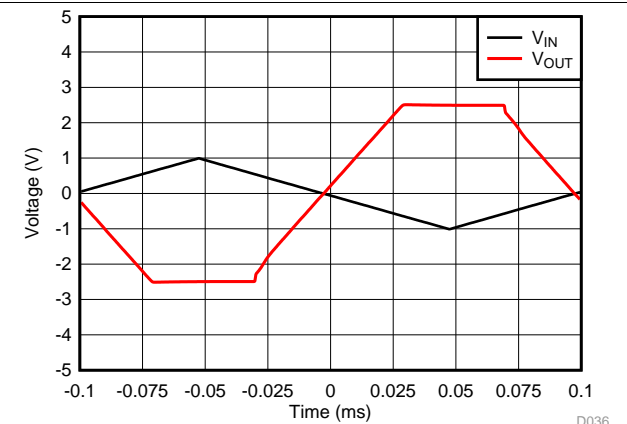

Figure 40. Shunt Sense Amplifier Overload Recovery Response

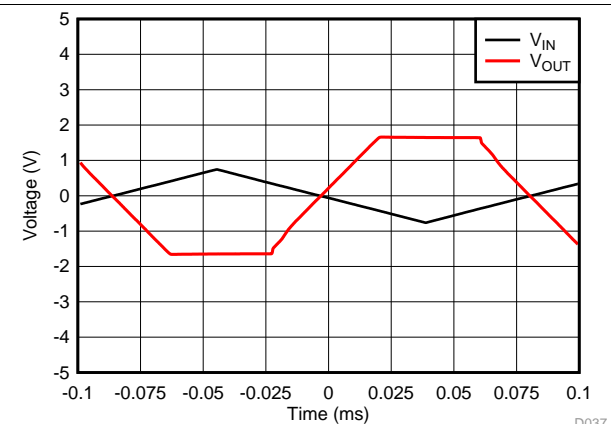

Figure 41. Shunt Sense Amplifier Overload Recovery Response

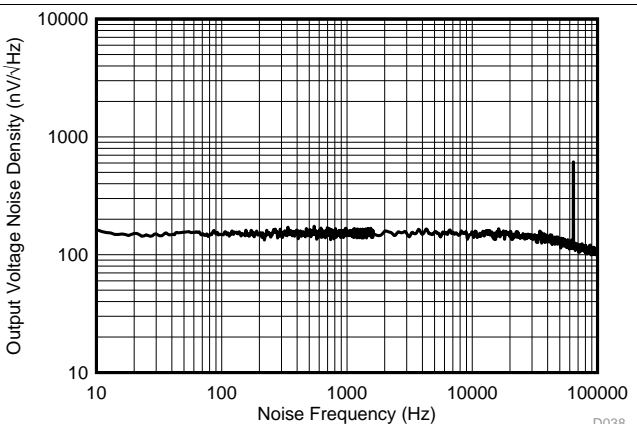

Figure 42. Shunt Sense Amplifier Output Voltage Noise Density vs Noise Frequency

Typical Characteristics (continued)

at $V_{DD} = 5\text{ V}$ and $T_A = +25^\circ\text{C}$ (unless otherwise noted)

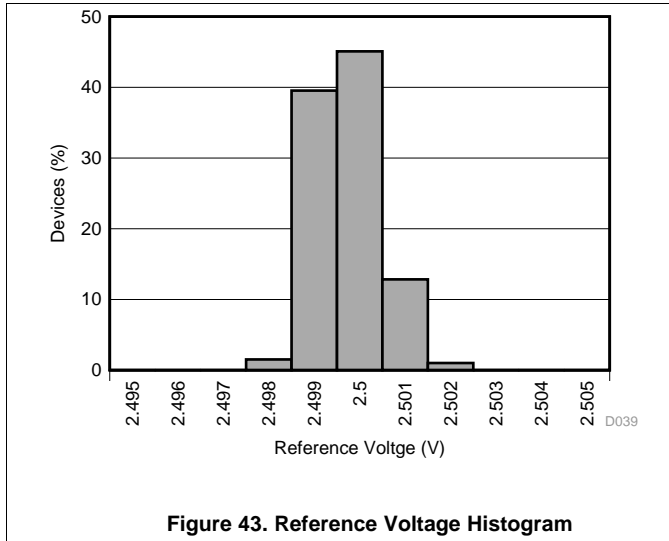

Figure 43. Reference Voltage Histogram

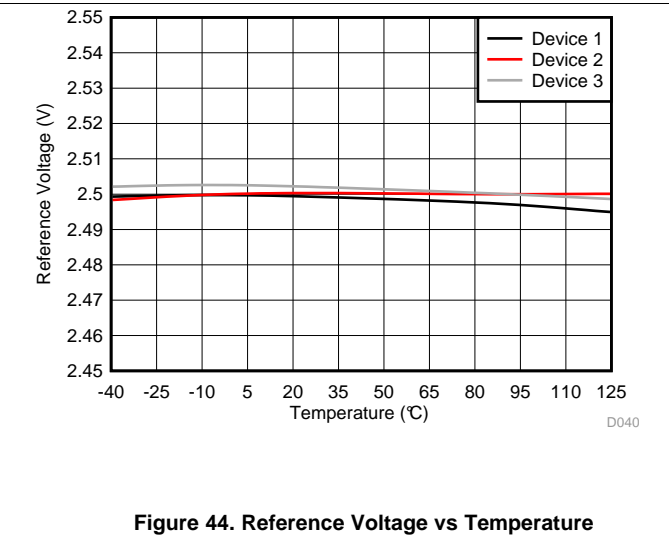

Figure 44. Reference Voltage vs Temperature

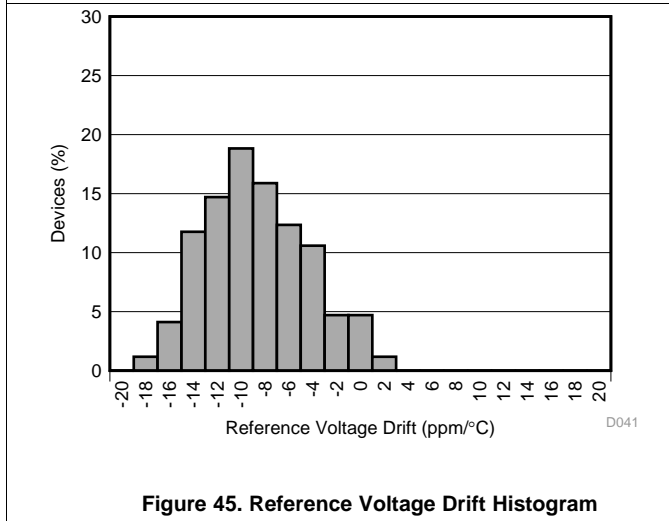

Figure 45. Reference Voltage Drift Histogram

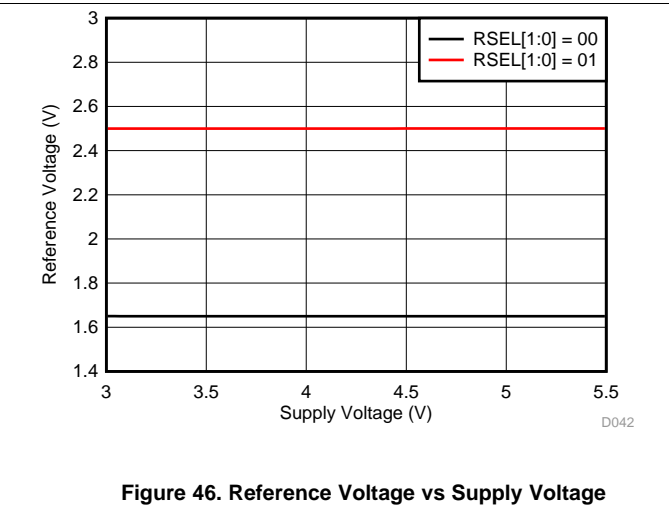

Figure 46. Reference Voltage vs Supply Voltage

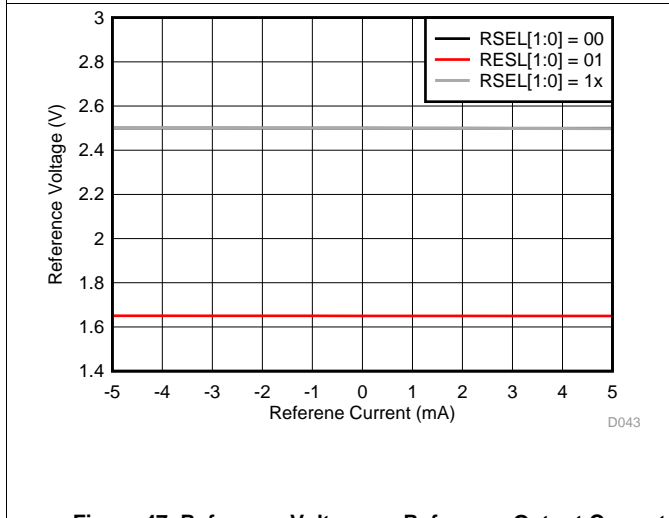

Figure 47. Reference Voltage vs Reference Output Current

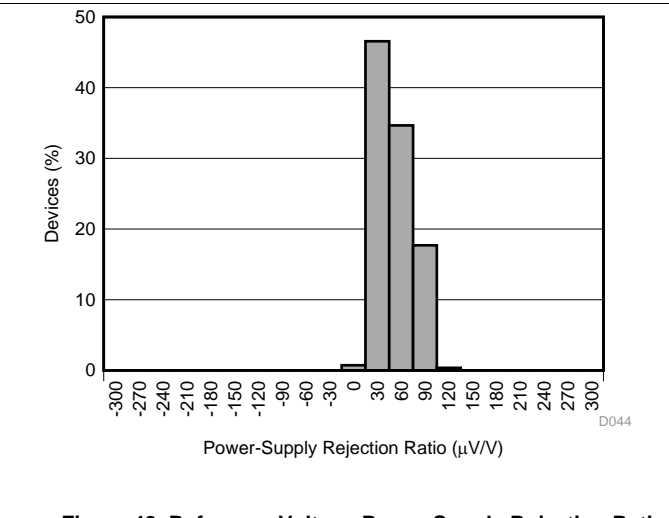

Figure 48. Reference Voltage Power-Supply Rejection Ratio Histogram

Typical Characteristics (continued)

at $V_{DD} = 5\text{ V}$ and $T_A = +25^\circ\text{C}$ (unless otherwise noted)

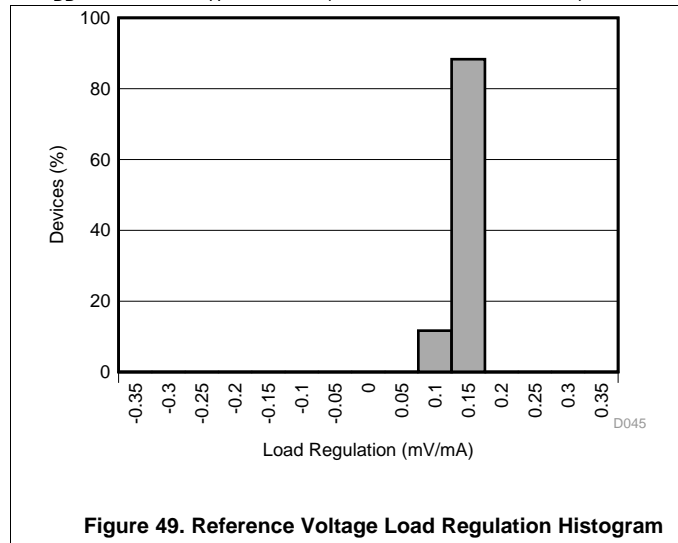

Figure 49. Reference Voltage Load Regulation Histogram

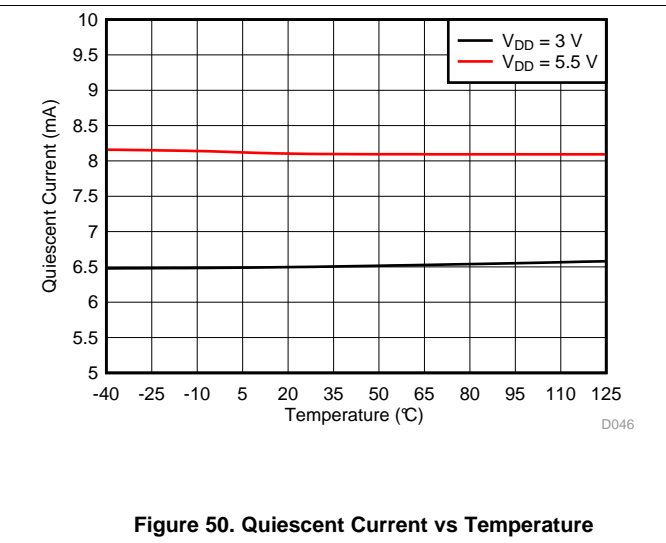

Figure 50. Quiescent Current vs Temperature

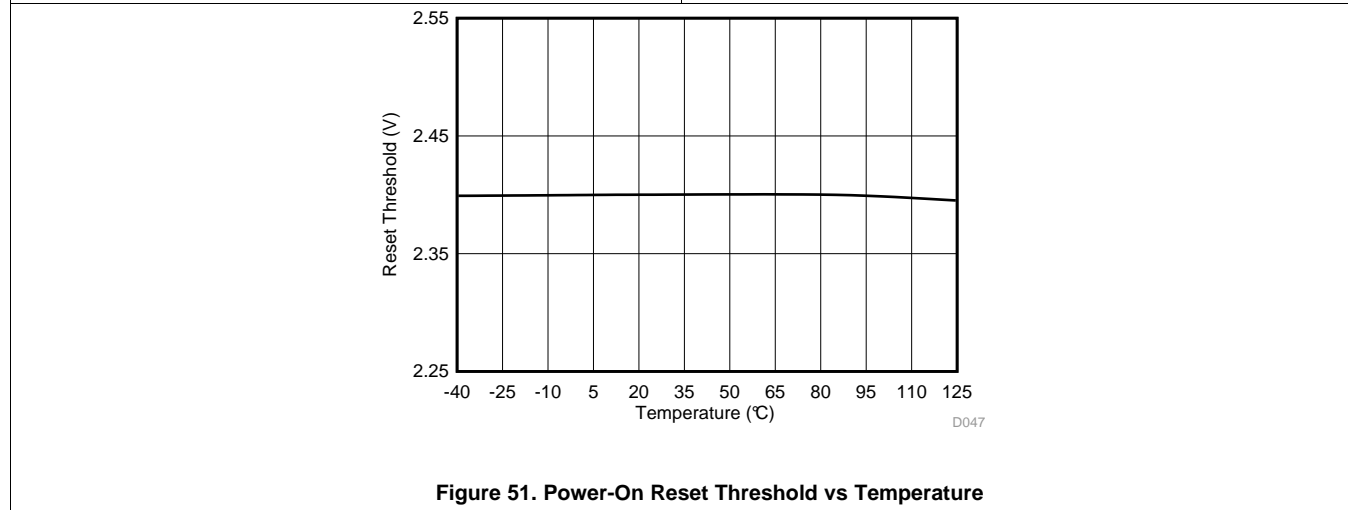

Figure 51. Power-On Reset Threshold vs Temperature

7 Detailed Description

7.1 Overview

The DRV421 is a fully-integrated, magnetic fluxgate sensor, with the necessary sensor conditioning and compensation circuitry for closed-loop current sensors. The device is inserted into an air gap of an external ferromagnetic toroid core to sense the magnetic field. A compensation coil wrapped around the magnetic core generates a magnetic field opposite to the one generated by the current flow to be measured.

At dc and low-frequencies, the magnetic field induced by the current in the primary conductor generates a flux in the magnetic core. The fluxgate sensor detects the flux in the DRV421. The device filters the sensor output to provide loop stability. The filter output connects to the built-in H-bridge driver that drives an opposing current through the external compensation coil. The compensation coil generates an opposite magnetic field that brings the original magnetic flux in the core back to zero.

At higher frequencies, the inductive coupling between the primary conductor and compensation coil directly drives a current through the compensation coil.

The compensation current is proportional to the primary current ($I_{PRIMARY}$), with a value that is calculated using [Equation 1](#):

$$I_{COMP} = I_{PRIMARY} / N_{WINDING}$$

where

- $N_{WINDING}$ = the number of windings of the compensation coil (1)

This compensation current generates a voltage drop across a small external shunt resistor, R_{SHUNT} . An integrated difference amplifier with a fixed gain of 4 V/V measures this voltage and generates an output voltage that is referenced to REF_{IN} and proportional to the primary current. The [Functional Block Diagram](#) section shows the DRV421 used as a closed-loop current sensor, for both single-ended and differential primary currents.

7.2 Functional Block Diagram

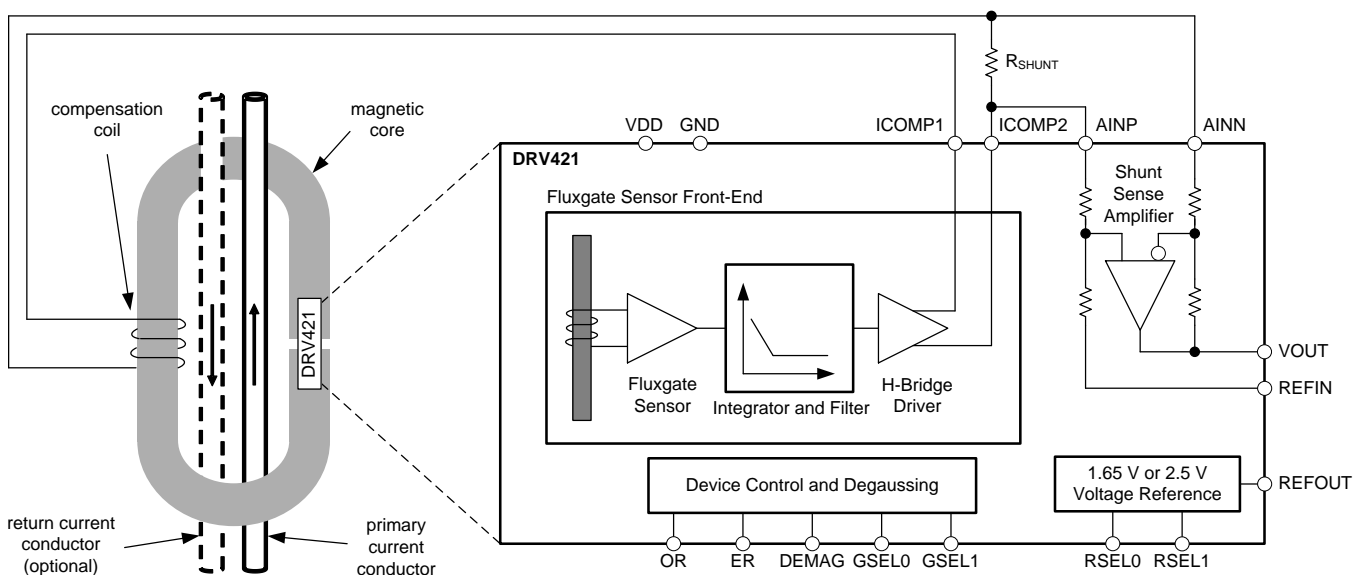

7.3 Feature Description

7.3.1 Fluxgate Sensor

The fluxgate sensor of the DRV421 is uniquely suited for closed-loop current sensors because of its high sensitivity, low noise, and low offset. The fluxgate principle relies on repeatedly driving the sensor in and out of saturation; therefore, the sensor is free of any significant magnetic hysteresis. The feedback loop accurately drives the magnetic flux inside the core to zero.

The DRV421 package is free of any ferromagnetic materials in order to prevent magnetization by external fields and to obtain accurate and hysteresis-free operation. Select nonmagnetizable materials for the printed circuit board (PCB) and passive components in the direct vicinity of the DRV421; see the [Layout Guidelines](#) section for more details.

[Figure 52](#) shows the orientation of the fluxgate sensor and the direction of magnetic sensitivity inside of the package. This orientation is marked by a straight line on top of the package.

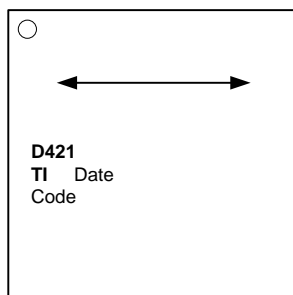

Figure 52. Orientation and Magnetic Sensitivity Direction of the Integrated Fluxgate Sensor

7.3.2 Integrator-Filter Function and Compensation Loop Stability

The DRV421 and the magnetic core are components of the system feedback loop that compensates the magnetic flux generated by the primary current. Therefore, the loop properties and stability depend on both components. Four key parameters determine the stability and effective loop gain at high frequencies:

GSEL[1:0] Filter gain setting pins of the DRV421

G_{CORE} Open-loop, current-to-field transfer of the magnetic core
Amount of magnetic field generated by 1 A of uncompensated primary current (unit is T/A).

N_{WINDING} Number of compensation coil windings

L Compensation coil inductance
A minimum inductance of 100 mH is required for stability. Higher inductance improves overload current robustness (see the [Overload Detection and Control](#) section).

To properly select the filter gain of the DRV421, combine these three parameters into a modified gain factor (G_{MOD}) using [Equation 2](#):

$$G_{MOD} = \frac{G_{CORE} \times N_{WINDING}}{L} \quad (2)$$

The effective loop gain is proportional to the current-to-field transfer of the magnetic core (larger field means larger gain) and number of compensation coil windings (larger number of windings means larger compensation field for a given input current). The compensation coil inductance adds a low-frequency pole to the system, thus a larger inductance reduces the effective loop gain at higher frequencies. A more detailed review of system loop stability is provided in application report [SLOA224, Designing with the DRV421: Control Loop Stability](#).

For stable operation with a wide range of magnetic cores, the DRV421 features an adjustable loop filter controlled with pins GSEL1 and GSEL0. [Table 1](#) lists the different filter settings and the related core properties. For standard closed-loop current transducer modules with medium inductance and small shunt resistor value, use gain setting 10. Gain setting 01 features a higher integrator-filter crossover frequency of 3.8 kHz, and is recommended for fault-current sensors with a large shunt resistor and medium inductance.

Feature Description (continued)

Table 1. DRV421 Loop Gain Filter Settings and Relation to Magnetic Core Parameters

GSEL1	GSEL0	COMPENSATION LOOP PROPERTIES		RANGE OF MODIFIED GAIN FACTOR G_{MOD}	RANGE OF COMPENSATION COIL INDUCTANCE L ($N_{WINDING} = 1000$ and $G_{CORE} = 0.6 \text{ mT/A}$)
		INTEGRATOR CORNER FREQUENCY	AC OPEN-LOOP GAIN		
0	0	3.8 kHz	8.5	$3 < G_{MOD} < 12$	$100 \text{ mH} < L < 200 \text{ mH}$
0	1	3.8 kHz	38	$1 < G_{MOD} < 3$	$200 \text{ mH} < L < 600 \text{ mH}$
1	0	1.9 kHz	25	$1 < G_{MOD} < 3$	$200 \text{ mH} < L < 600 \text{ mH}$
1	1	1.9 kHz	70	$0.3 < G_{MOD} < 1$	$600 \text{ mH} < L < 2 \text{ H}$

Table 1 gives an initial gain-setting recommendation based on a simulation model of a generic magnetic core. Secondary magnetic effects, such as eddy current losses and core hysteresis, can lead to different optimal settings. Therefore, make sure to verify the correct gain setting by measuring the response of the current sensor to an input current step at compensation driver output pins ICOMP1 and ICOMP2. Examples of measurement results with a magnetic core of 300 mH, 1000 compensation coil windings, and different DRV421 gain settings are shown in Figure 53 to Figure 56.

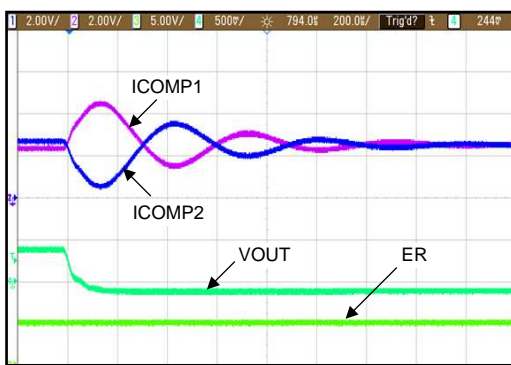

Figure 53. Settling of ICOMP1 and ICOMP2 with GSEL[1:0] = 00

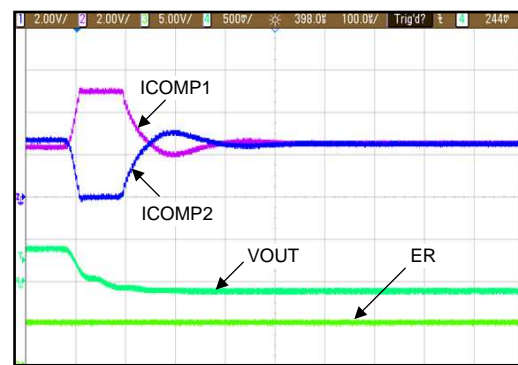

Figure 54. Settling of ICOMP1 and ICOMP2 with GSEL[1:0] = 01

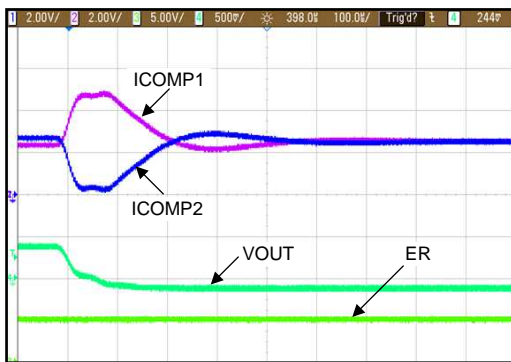

Figure 55. Settling of ICOMP1 and ICOMP2 with GSEL[1:0] = 10

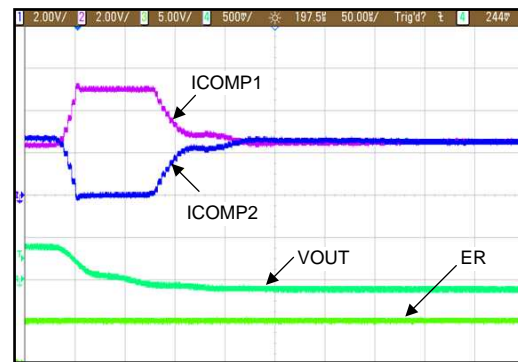

Figure 56. Settling of ICOMP1 and ICOMP2 with GSEL[1:0] = 11

These measurement examples show a stable response for both GSEL[1:0] = 10 and 11 settings. However, inductive coupling between the primary current and compensation coil makes it difficult to measure high-frequency instability. Therefore, use the lowest gain setting that yields a stable response; in this case, use gain setting 10.

7.3.3 H-Bridge Driver for Compensation Coil

The H-bridge compensation coil driver provides the current for the compensation coil at pins ICOMP1 and ICOMP2. A fully-differential driver stage maximizes the driving voltage that is needed to overcome the wire resistance and inductance of the coil with a single 3.3-V or 5-V supply. The low impedance of the H-bridge driver outputs over a wide frequency range provides a smooth transition between the compensation frequency range of the integrator-filter stage and the high-frequency range of the primary current that directly couples into the compensation coil according to the winding ratio (transformer effect).

The common-mode voltage of the H-bridge driver outputs is set by the RSEL pins (see the [Voltage Reference](#) section). Thus, the common-mode voltage of the shunt sense amplifier is matched if the internal reference is used.

The two compensation driver outputs are protected and accept inductive energy. However, for high-current sensors, add external protection diodes (see the [Protection Recommendations](#) section).

Consider the polarity of the compensation coil connection to the output of the H-bridge driver. If the polarity is incorrect, the H-bridge output drives to the power supply rails, even at low primary-current levels. In this case, interchange the connection of pins ICOMP1 and ICOMP2 to the compensation coil.

7.3.4 Shunt Sense Amplifier

The compensation coil current creates a voltage drop across the external shunt resistor, R_{SHUNT} . The internal differential amplifier senses this voltage drop. This differential amplifier offers wide bandwidth and a high slew rate for fast current sensors. Excellent dc stability and accuracy result from an autozero technique. The voltage gain is 4 V/V, set by precisely-matched and thermally-stable internal resistors.

Both AINN and AINP differential amplifier inputs are connected to the shunt resistor. This resistor, in series with the internal 10-k Ω resistor, affects the overall gain and causes an additional gain error; this gain error is often negligible. However, if a common-mode rejection of 70 dB is desired, the match of both divider ratios must be higher than 1/3000. Therefore, for best common-mode rejection performance, place a dummy shunt resistor (R_5) with a value higher than the shunt resistor in series with the REFIN pin to restore matching of both resistor dividers, as shown in [Figure 57](#).

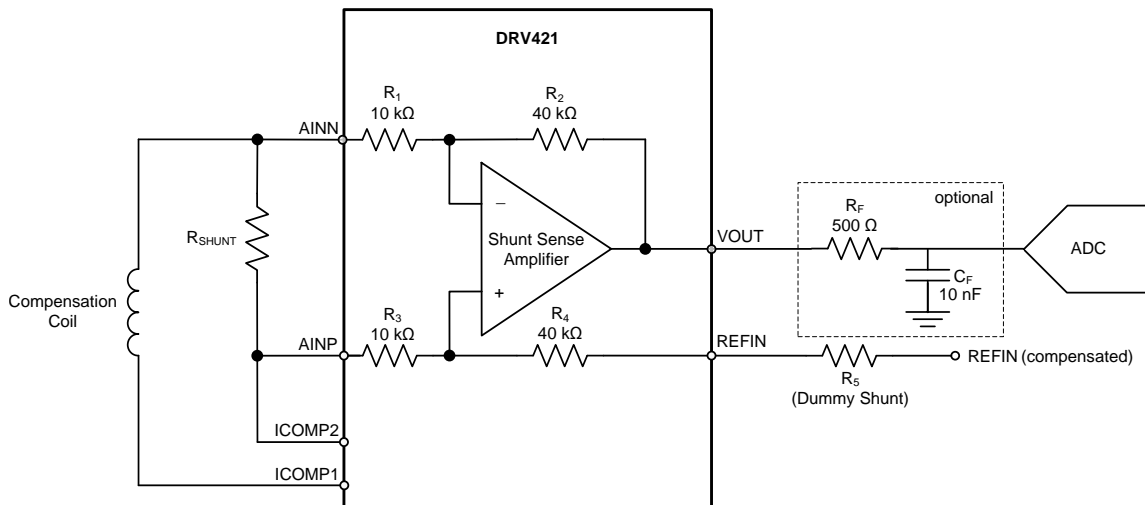

Figure 57. Internal Difference Amplifier with Example of a Decoupling Filter

For an overall gain of 4 V/V, calculate the value of R_5 using [Equation 3](#):

$$4 = \frac{R_2}{R_1} = \frac{R_4 + R_5}{R_{SHUNT} + R_3}$$

where:

- $R_2 / R_1 = R_4 / R_3 = 4$
- $R_5 = R_{SHUNT} \times 4$

(3)

If the input signal is large, the amplifier output drives close to the supply rails. The amplifier output is able to drive the input of a successive approximation register (SAR) analog-to-digital converter (ADC). For best performance, add an RC low-pass filter stage between the shunt sense amplifier output and the ADC input. This filter limits the noise bandwidth and decouples the high-frequency sampling noise of the ADC input from the amplifier output. For filter resistor R_F and filter capacitor C_F values, refer to the specific converter recommendations in the respective product data sheet.

The shunt sense amplifier output drives 100 pF directly and shows 50% overshoot with a 1-nF capacitance. Filter resistor R_F extends the capacitive load range. Note that with an R_F of only 20 Ω , the load capacitor must be either less than 1 nF or more than 33 nF to avoid overshoot; with an R_F of 50 Ω , this transient area is avoided.

Reference input REFIN is the common-mode voltage node for output signal VOUT. Use the internal voltage reference of the DRV421 by connecting the REFIN pin to reference output REFOUT. To avoid mismatch errors, use the same reference voltage for REFIN and the ADC. Alternatively, use an ADC with a pseudodifferential input, with the positive input of the ADC connected to the VOUT and the negative input connected to REFIN of the DRV421.

7.3.5 Overrange Comparator

High peak current across the shunt resistor can generate a voltage drop that overloads the shunt sense amplifier input. The open-drain, active-low output overrange pin (OR) indicates an overvoltage condition of the amplifier. The output of this flag is suppressed for 3 μ s, preventing unwanted triggering from transients and noise. This pin returns to high as soon as the overload condition is removed; an external pull-up resistor is required to return the OR pin to high.

This OR output can be used as a window comparator to actively shut off circuits in the system. The value of the shunt resistor defines the operating window for the current, and sets the ratio between the nominal signal and the trip level of the overrange comparator. The trip level (I_{MAX}) of this window comparator is calculated using [Equation 4](#):

$$I_{MAX} = \text{Input Voltage Swing} / R_{SHUNT}$$

where

- Input Voltage Swing = Output Voltage Swing / Gain (4)

For example, with a 5-V supply, the output voltage swing is approximately ± 2.45 V (load and supply voltage-dependent).

The gain of 4 V/V enables an input voltage swing of ± 0.6125 V.

The resulting trip level is $I_{MAX} = 0.6125 \text{ V} / R_{SHUNT}$.

See [Figure 32](#) and [Figure 33](#) in the *Typical Characteristics* section for details.

Common window comparators use a preset level to detect an overrange condition. The DRV421 internally detects an overrange condition as soon as the amplifier exceeds the linear operating range, not just at a preset voltage level. Therefore, the error is reliably indicated in faults such as output-short, low-load, or low-supply conditions. This configuration is a safety improvement if compared to a standard voltage-level comparator.

The internal resistance of the compensation coil may prevent high compensation current flow because of H-bridge driver overload; therefore, the shunt sense amplifier might not overload. However, a fast rate of change of the primary current transmitted through transformer effect safely triggers the overload flag.

7.3.6 Voltage Reference

The internal precision voltage reference circuit offers low drift performance at the REFOUT output pin and is used for internal biasing. The reference output is intended to be the common-mode voltage of the output (VOUT pin) to provide a bipolar signal swing. This low-impedance output tolerates sink and source currents of ±5 mA. However, fast load transients can generate ringing on this line. A small series resistor of a few ohms improves the response, particularly for capacitive loads equal to or greater than 1 μF.

Adjust the value of the voltage reference output to the power supply of the DRV421 using mode selection pins RSEL0 and RSEL1, as shown in Table 2.

Table 2. Reference Output Voltage Selection

MODE	RSEL1	RSEL0	DESCRIPTION
$V_{REFOUT} = 2.5\text{ V}$	0	0	Use with sensor module supply of 5 V
$V_{REFOUT} = 1.65\text{ V}$	0	1	Use with sensor module supply of 3.3 V
Ratiometric output	1	x	Provides output centered on $V_{DD} / 2$

In ratiometric output mode, an internal resistor divider divides the power supply voltage by a factor of two.

For current sensor modules with a reference input pin, the DRV421 also allows overwriting the internal reference with an external reference voltage, V_{EXT} , as shown in Figure 58. If there is a significant difference between the external and the internal voltage, resistor R_5 limits the current flow from the internal reference. In this case, the internal reference sources current I_{REFOUT} shown in Equation 5:

$$I_{REFOUT} = \frac{V_{REFOUT} - V_{EXT}}{600\ \Omega} \tag{5}$$

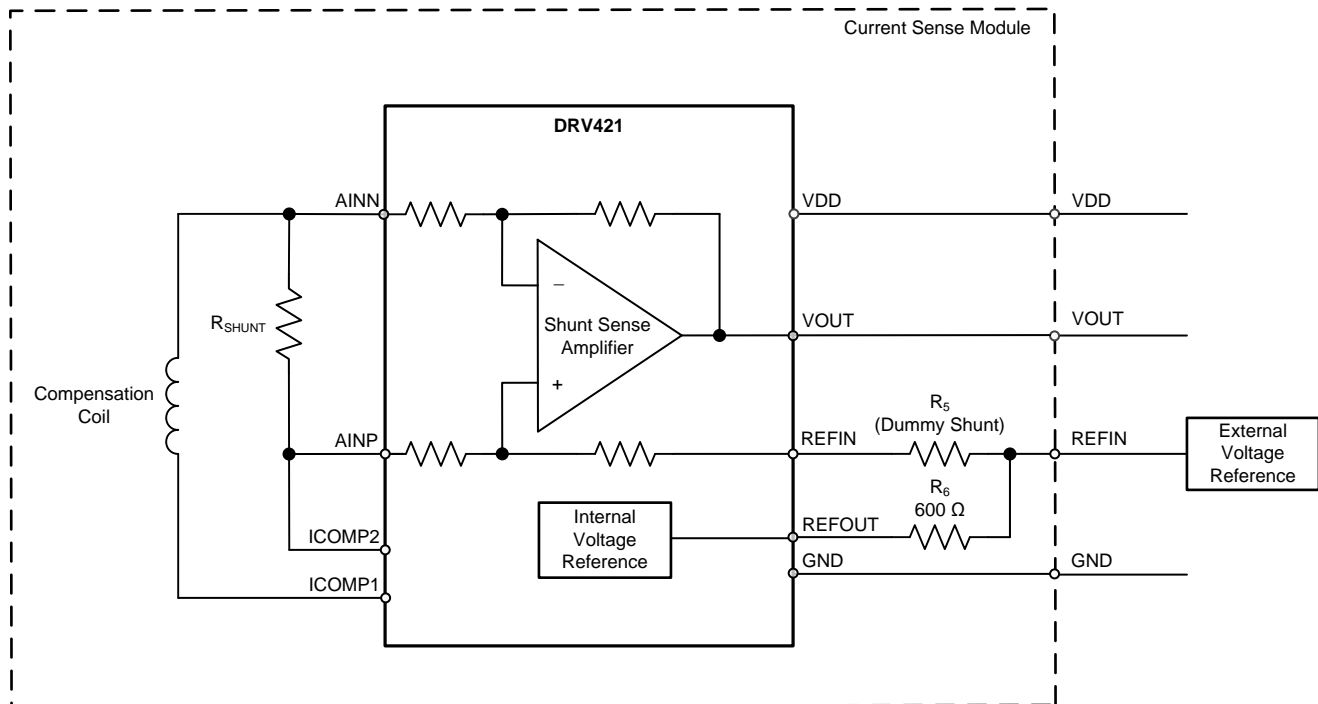

Figure 58. DRV421 with External Reference

The example of 600 Ω for R_6 was chosen for illustration purposes; different values are possible. If no external reference is connected, R_6 has little impact on the common-mode rejection of the shunt sense amplifier; therefore, use a resistor value that is as small as possible.

7.3.7 Overload Detection and Control

Magnetic fluxgate sensors have a very high sensitivity and allow detection of small magnetic fields. These sensors are ideally suited for use in closed-loop current modules applications because the high sensitivity makes sure that the field inside the core gap is accurately driven to zero. However, for large fields, the fluxgate saturates and causes the output to return to zero, as shown in Figure 59.

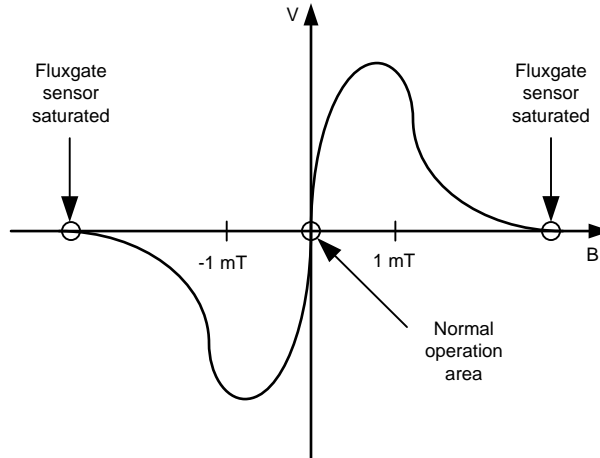

Figure 59. Typical Fluxgate Sensor Response to Magnetic Fields

In normal operation, the feedback loop keeps the magnetic field close to zero. However, large overload currents that exceed the measurement range (for example, short-circuit currents) saturates the fluxgate. The behavior is shown in Figure 60, where the compensation current, magnetic field in the core, and fluxgate output are shown for the case of a 1000-A primary current step.

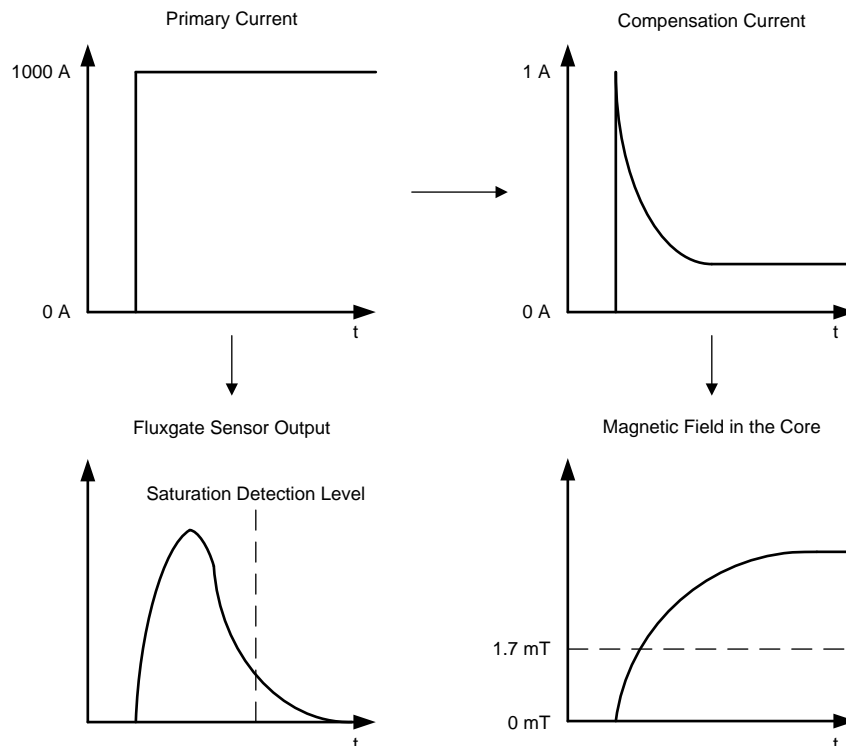

Figure 60. Closed-Loop Current Sensor Response to an Overloaded Step Current

Use the inverse of [Equation 1](#) to calculate the current measurement range. For example, if the compensation coil has 1000 windings, the maximum measurement range is 210 A at a 5-V supply (210-mA minimum compensation driver capability \times 1000 windings). The inductive coupling between primary current and compensation coil initially provides a correct compensation current. However, over time, the compensation current drops to 210 mA and the field inside the core increases beyond the measurement range of the fluxgate. Thus, the sensor output returns to zero because of saturation.

This zero output causes unpredictable behavior in the analog control loop. For example, as a result of an invalid fluxgate output, the H-bridge drives the wrong compensation current and generates a large magnetic field through the compensation coil. This magnetic field keeps the fluxgate in saturation and leads to system lockup. This unpredictable behavior exists for any fluxgate-based current sensor.

For proper handling of overload currents, the DRV421 features a two-step overload detection and control function. Firstly, the polarity of the last four fluxgate sensor outputs exceeding a threshold value of approximately 13 μ T are internally stored. Secondly, the DRV421 features an additional circuitry that verifies every 4 μ s whether the fluxgate is saturated. If saturation is detected, digital circuitry overrides the fluxgate output and provides a high output according to the polarity detected during the last valid sensor output. As a result, the H-bridge drives the outputs to the supply rails, making sure that the magnetic field returns to within the fluxgate range as soon as the current returns to within the measurement range. After this happens, the fluxgate is no longer saturated, and normal analog feedback loop operation resumes. During fluxgate saturation, the error pin is pulled low to signal that the current exceeds the measurement range (see the [Error Flag](#) section).

For correct operation of this overload control feature, at least 10 μ s are required between the time the field exceeds the polarity detection threshold (13 μ T) and the saturation trip level (1.7 mT). Initially, fast primary current steps are inductively coupled to the compensation coil (transformer effect); therefore, the primary current rise time is not limited. Instead, the rise time is determined by the compensation coil inductance; a larger inductance leads to a slower compensation current decrease. The minimum required inductance is 100 mH; for optimal robustness, use 300 mH (see the [Magnetic Core Design](#) section for detailed requirements).

7.3.8 Magnetic Core Demagnetization

Ferromagnetic cores can have a significant remanence (residual magnetism in the absence of any currents). This core magnetization is caused by strong external magnetic fields, overcurrent conditions in the system, or if a significant primary current flows when the sensor is not powered. This remaining magnetic field is indistinguishable from an actual primary current, and creates a magnetic offset error. This magnetic offset error limits the precision and the dynamic range of the current sensor, and is independent of the fluxgate sensor front-end offset specified in this data sheet.

To reduce errors caused by core magnetization, the DRV421 features a unique closed-loop demagnetization feature. Conventional open-loop demagnetization techniques rely on driving a fixed ac waveform through the compensation coil. Instead, the DRV421 demagnetization feature first measures the magnetic offset using its integrated fluxgate sensor, and then drives a controlled ac waveform to reduce the measured magnetization. This method results in significantly better results. Moreover, any fluxgate offset is part of the closed-loop demagnetization measurement, and therefore removed along with core magnetization, leaving only fluxgate offset drift over temperature as an error source.

Start the demagnetization feature on demand by pulling the DEMAG pin high for at least 25 μ s. This process starts a 500-ms demagnetization cycle. During this time, the error pin (ER) is pulled low to indicate that the output is not valid. When DEMAG is high during power up, the demagnetization cycle initiates immediately after the supply voltage crosses the power-up threshold. Hold DEMAG low to avoid this cycle during start up. To abort the demagnetization cycle, pull DEMAG low for longer than 25 μ s. [Figure 61](#) shows the ICOMPx output behavior during a demagnetization sequence. [Figure 62](#) shows the reduced error resulting from core demagnetization.

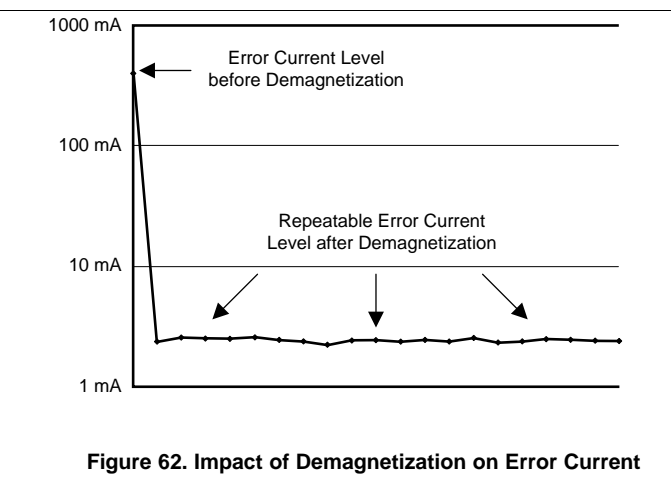
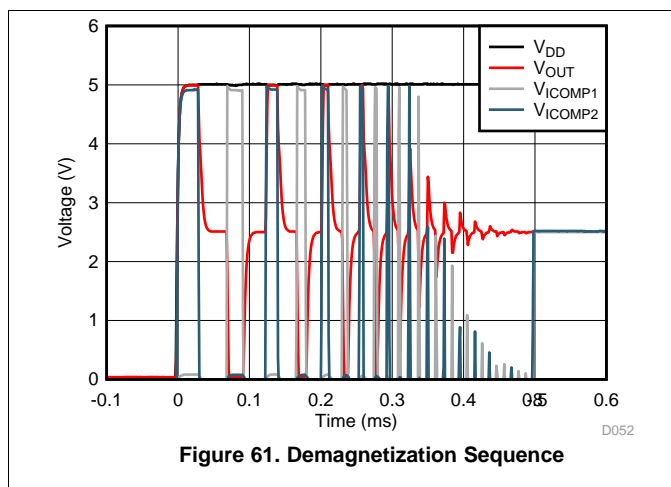

During a demagnetization cycle, the primary current must be zero because the resulting magnetic field cannot be distinguished from the remanence of the core. A demagnetization cycle in the presence of primary current (or any other sources of magnetic field) leads to residual errors because the demagnetization feature attempts to reduce the primary-generated field to zero, but significantly magnetizes the core instead of demagnetizing the core. If a primary current is present that is large enough to saturate the fluxgate sensor during start up, the DRV421 skips demagnetization (regardless of the level on the DEMAG pin), and the search function starts instead (see the [Search Function](#) section for more details).

To reduce effects from the earth's magnetic field, degauss in the same orientation as nominal operation of the system.

7.3.9 Search Function

Closed-loop current sensors usually require primary current to be applied only after the sensor is powered up. This requirement allows the feedback loop to start from zero current operation; the magnetic core is maintained at zero flux at all times, thus preventing magnetization. Moreover, the DRV421 integrated fluxgate has a limited measurement range of 1.7 mT. As a result, the presence of a significant primary current at power up saturates the fluxgate, and the system feedback loop does not work; similar to the presence of an overload current (see the [Overload Detection and Control](#) section).

The DRV421 search function allows for a power up in presence of primary dc current. If the fluxgate is saturated at power up, the digital logic of the DRV421 connects ICOMP1 to VDD and COMP2 to GND for 30 ms. Because of the compensation coil inductance, the compensation current slowly increases during this time, and depending on the primary current polarity, may at some point compensate the primary current. In this case, the fluxgate sensor desaturates and normal operation initiates. If the fluxgate sensor is still saturated after 30 ms, the voltage polarity on ICOMPx pins is inverted (ICOMP1 = GND, ICOMP2 = VDD) and the process repeats for opposite primary current polarity. If the fluxgate remains saturated after 60 ms, the error state persists and the error pin ER remains active low. [Figure 63](#) shows a search sequence starting with the wrong polarity.

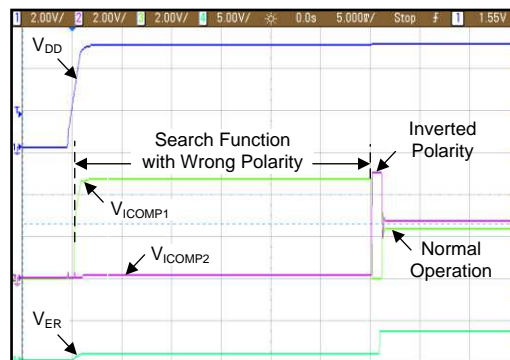

Figure 63. Search Sequence Starting with Wrong Polarity

The search function cannot be used for primary ac currents. Moreover, the presence of primary current before the sensor is powered up may lead to core magnetization, and thus offset shift. Therefore, for robust operation, do not power up in the presence of primary currents.

7.3.10 Error Flag

The DRV421 features an error output (ER pin) that is activated under multiple conditions. The error flag is active when the output voltage is not proportional to the primary current; during a power fail or brownout; during a demagnetization cycle; or when the magnetic field on the fluxgate is greater than 1.7 mT (saturation of the fluxgate). Saturation is usually caused by either the consequence of an overload current (see the [Overload Detection and Control](#) section) or results from a power-up in the presence of a primary current (see the [Search Function](#) section).

The error flag resets as soon as the error condition is no longer present and the circuit has returned to normal operation. The error flag is an open-drain logic output. Connect the error flag to the overrange flag for a wired-OR; for proper operation, use an external pull-up resistor. The following conditions result in error flag activation (ER asserts low):

1. For 80 μ s after power-up
2. If a supply-voltage brownout condition ($V_{DD} < 2.4$ V) lasts for more than 20 μ s
3. If the sensed magnetic field is > 1.7 mT because:
 - Overload control is active
 - Search function is active
4. Demagnetization cycle is active (see the [Magnetic Core Demagnetization](#) section)

7.4 Device Functional Modes

The DRV421 has a single functional mode and is operational when the power-supply voltage is greater than 3 V. The maximum power supply voltage for the DRV421 is 5.5 V.

8 Application and Implementation

NOTE

Information in the following applications sections is not part of the TI component specification, and TI does not warrant its accuracy or completeness. TI's customers are responsible for determining suitability of components for their purposes. Customers should validate and test their design implementation to confirm system functionality.

8.1 Application Information

8.1.1 Magnetic Core Design

The high sensitivity, low offset, and low noise of the DRV421 fluxgate sensor enable a high-performance closed-loop current sensor module. For good module performance, an appropriate magnetic core design is required.

[Table 3](#) lists the DRV421 and magnetic core specifications with relation to the overall current module specifications.

Table 3. Current-Sensor Module Performance versus DRV421 Specifications and Magnetic Core Performance

CURRENT SENSOR MODULE PARAMETER	PERFORMANCE DETERMINED BY:
Offset and offset drift	DRV421 fluxgate sensor front-end: offset and offset drift
Offset on start-up and after overload condition	Magnetic core: magnetization (see the Magnetic Core Demagnetization section)
Noise	DRV421 fluxgate sensor front-end: noise
Linearity error	DRV421 fluxgate sensor front-end: AC open-loop gain
Gain error	Magnetic core: Permeability, geometry, and actual number of compensation coil windings
Measurement range	1) DRV421 fluxgate sensor front-end: H-bridge peak current 2) Compensation coil: number of windings and resistance 3) Value of the external shunt resistor
Neighbor-current rejection (crosstalk)	Magnetic core: permeability, sensor gap design, and magnetic shielding
Bandwidth and gain flatness	1) DRV421 fluxgate sensor front-end: AC open-loop gain setting 2) Magnetic core: high-frequency behavior of the core and inductance of the compensation coil 3) Value of the external shunt resistor
Common-mode current rejection (for fault current sensors)	Magnetic core: permeability, actual position of the primary current conductors, and magnetic shielding

For further details, see application report [SLOA223](#), *Designing with the DRV421: Closed Loop Current Sensor Specifications*.

Application Information (continued)

8.1.2 Protection Recommendations

Inputs AINP and AINN require external protection to limit the voltage swing to within 6 V beyond both supply rails. Driver outputs ICOMP1 and ICOMP2 handle high-current pulses protected by internal clamp circuits to the supply voltage. If large magnitude overcurrents are expected, connect external Schottky diodes to the supply rails to protect the DRV421 from damage.

CAUTION

Large overcurrents may drive the power supply above the normal operating voltage. Route large overcurrent pulses away from the device using diodes connected to the supply, as shown in the [typical application](#) on the front page. To prevent these pulses from driving up the supply voltage, and prevent damage to the DRV421 and other components in the circuit, use an additional supply clamp, as shown in [Figure 64](#). All other pins offer standard protection; see the [Absolute Maximum Ratings](#).

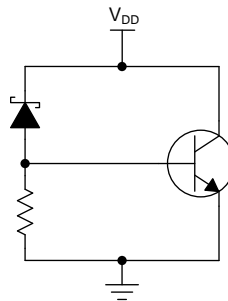

Figure 64. Additional Supply Clamp for the DRV421

8.2 Typical Application

8.2.1 Closed-Loop Current Sensing Module

Closed-loop current sensor modules (Figure 65) measure currents over a wide frequency range, including dc currents. These sensor modules offer a contact-free sensing method and excellent galvanic isolation performance, combined with high resolution, accuracy, and reliability. The DRV421 is designed for use in this kind of application.

At dc and in low-frequency range, the magnetic field induced by the primary current is sensed by the DRV421 fluxgate sensor. The sensed signal is filtered by the DRV421 and the internal H-bridge driver generates a proportional compensation current. The compensation current flows through the compensation coil, and generates a magnetic field. This magnetic field drives the original magnetic flux in the core back to zero. The value of this magnetic field is increased by the number of compensation coil windings. Therefore, use Equation 1 to calculate the required compensation current for a given primary current.

At higher frequencies, the magnetic field induced by the primary current directly couples into the compensation coil and generates a current. The low impedance of the H-bridge driver does not influence the value of this current. Also in this case, the value of the compensation current is the value of the primary current divided by the number of compensation coil windings.

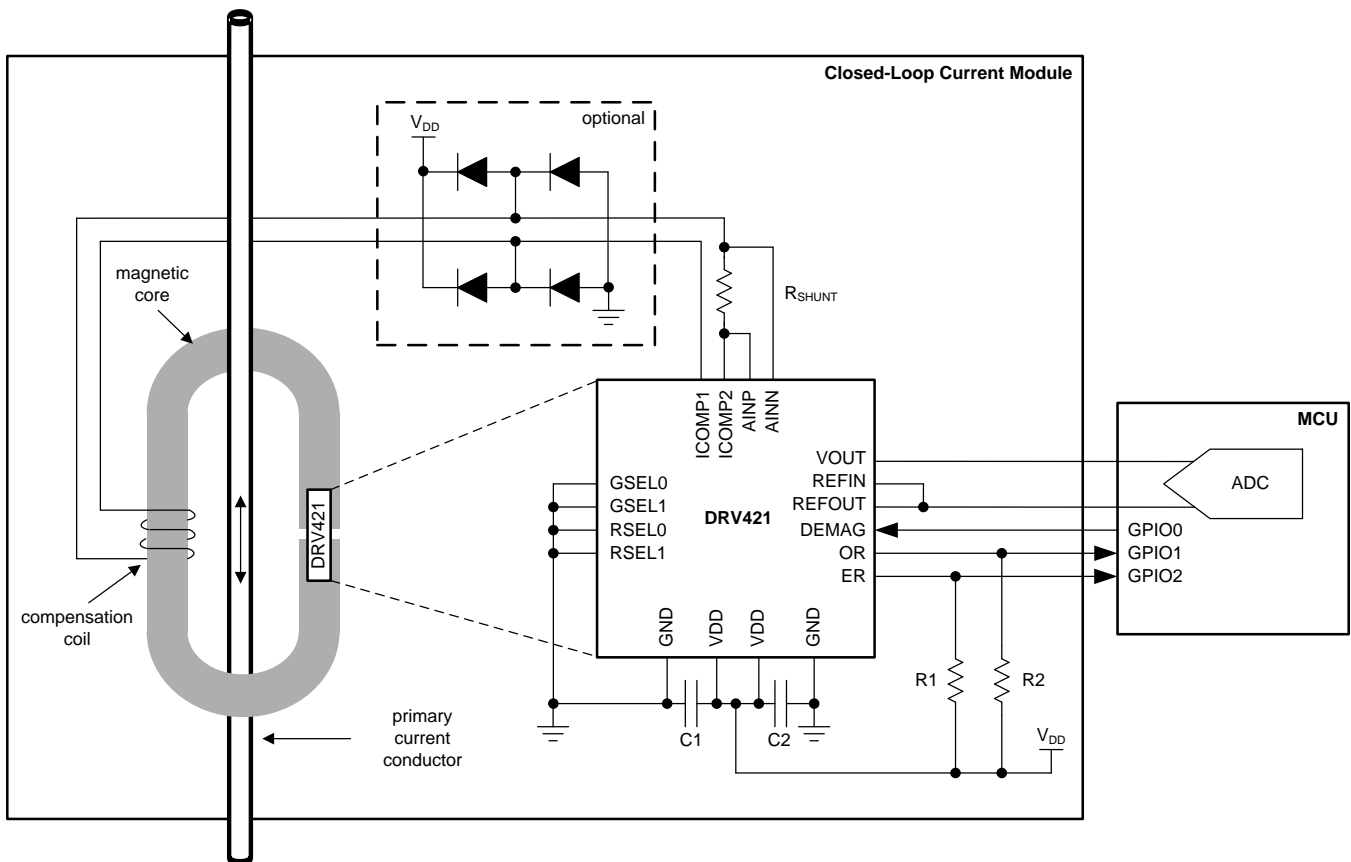

Figure 65. Closed-Loop Current Sensing Module

Typical Application (continued)

8.2.1.1 Design Requirements

A closed-loop current sensing module contains the DRV421, the magnetic core with a compensation coil, and a shunt resistor. To increase the robustness of the module to high primary current peaks, use additional protection diodes. See application report [SLOA223](#), *Designing with the DRV421: Closed Loop Current Sensor Specifications*, for additional information on the magnetic core and compensation coil design. The DRV421 output voltage is calculated as described in [Equation 6](#):

$$V_{OUT} = I_{PRIM} \times \left(\frac{N_{PRIM}}{N_{WINDING}} \right) \times R_{SHUNT} \times G$$

where:

- I_{PRIM} = primary current value
 - N_{PRIM} = the number of windings of the primary current conductor
 - $N_{WINDING}$ = the number of windings of the compensation coil
 - R_{SHUNT} = shunt resistor value
 - G = shunt sense amplifier gain; default value is 4
- (6)

8.2.1.2 Detailed Design Procedure

The compensation current creates a voltage drop across the shunt resistor. The maximum shunt resistor value is limited by supply voltage V_{DD} , the compensation current range, and the resistance of the compensation coil, as described in [Equation 7](#):

$$R_{SHUNT} + R_{COIL} \leq \frac{V_{ICOMP(MIN)}}{I_{ICOMP}} \quad (7)$$

The voltage drop across the shunt resistor is sensed by the DRV421 shunt sense amplifier with a gain of four. For proper operation, keep the resulting output voltage at VOUT pin within the voltage output swing range specified in the [Electrical Characteristics](#).

8.2.1.3 Application Curves

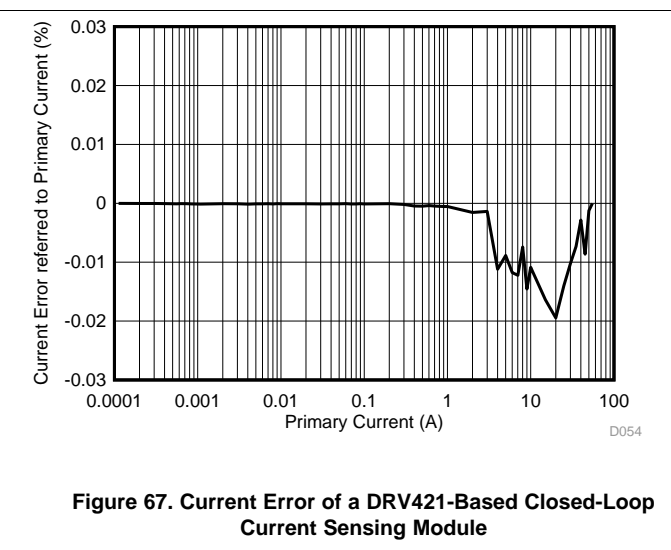
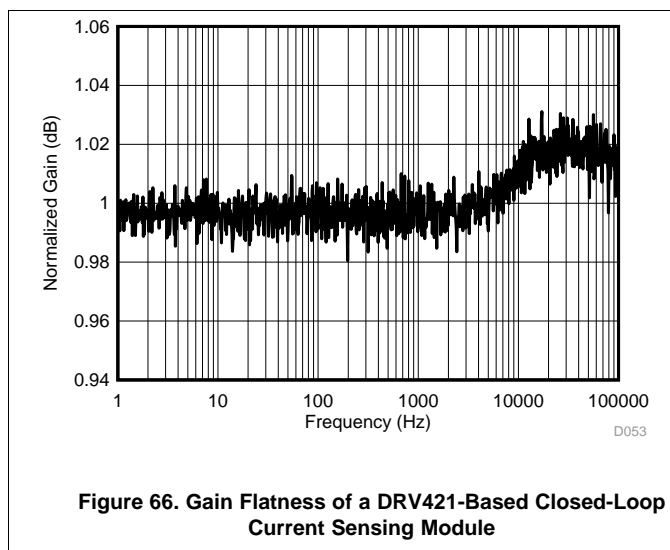

Typical Application (continued)

8.2.2 Differential Closed-Loop Current Sensing Module

The differential closed-loop current sensing module (Figure 68) measures the difference between two or more currents. Typical end-applications for such modules are leakage or residual current sensors. The high sensitivity of the fluxgate sensor and the low temperature drift make the DRV421 a suitable choice for this type of modules. The principle operation is the same as that of the closed-loop current module described in the [Closed-Loop Current Sensing Module](#) section. The compensation current corresponds to the current difference between the primary conductors.

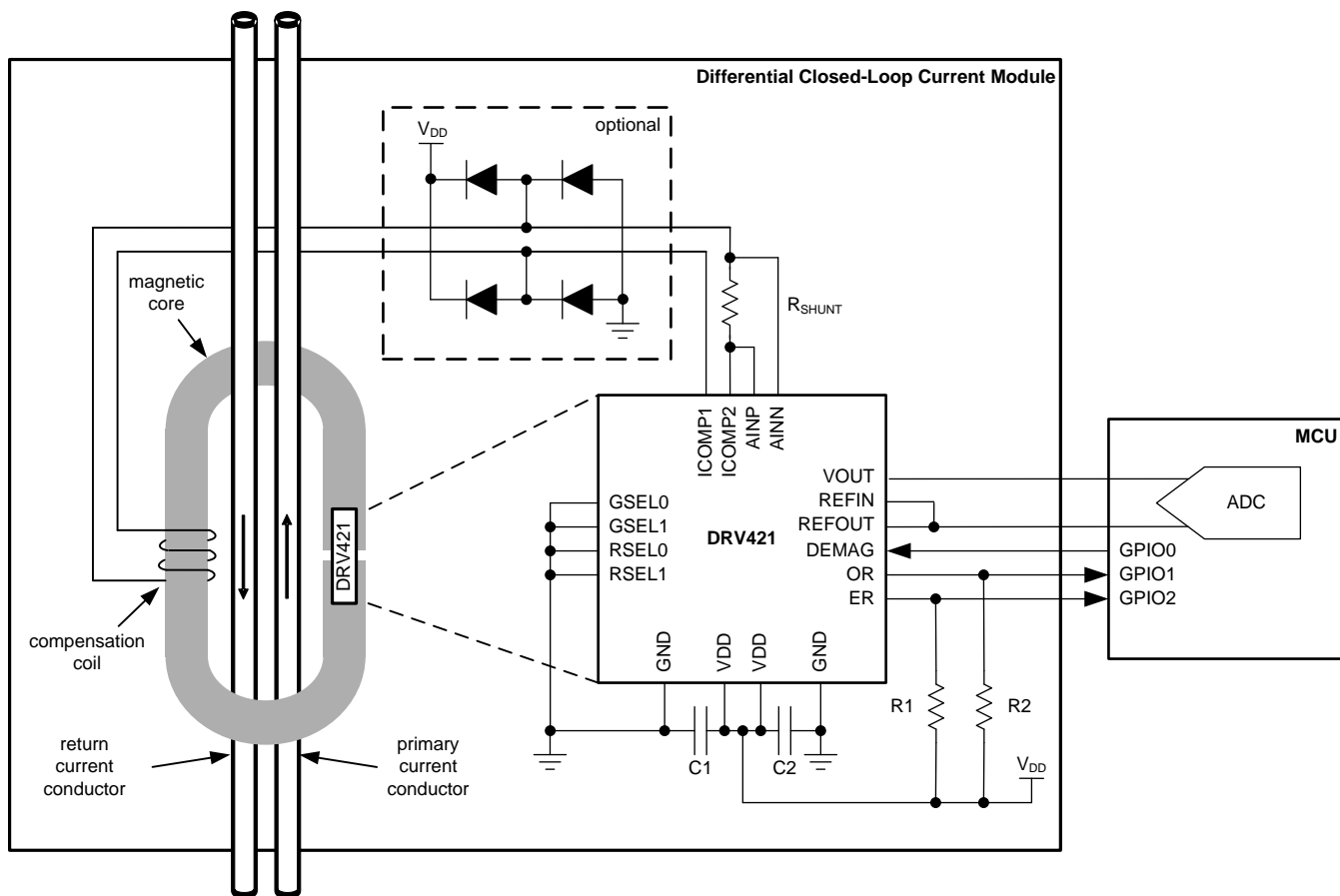

Figure 68. Differential Closed-Loop Current Sensing Module

Typical Application (continued)

8.2.2.1 Design Requirements

As with the previous application, the compensation current creates a voltage drop across the shunt resistor. The maximum shunt resistor value is limited by supply voltage V_{DD} , the compensation current range, and the resistance of the compensation coil; see [Equation 7](#).

However, in applications that sense leakage or residual currents, the difference between the primary currents is zero in normal operation. In fault condition only, there is a small difference current that is sensed in order to shut down the system to prevent damage to the device or the user. In this case, the compensation current is also very low, usually only in the range of few mA. Therefore, use a higher shunt resistor value in this case to support high sensitivity on system level. Consider the impact of shunt resistor value on gain and gain flatness as described in application report [SLOA223](#), *Designing with the DRV421: Closed Loop Current Sensor Specifications*.

8.2.2.2 Detailed Design Procedure

For differential current sensing modules with a large shunt resistor and medium compensation coil inductance, use the gain setting that features the higher cross-over frequency of 3.8 kHz: GSEL[1:0] = 01.

8.2.2.3 Application Curve

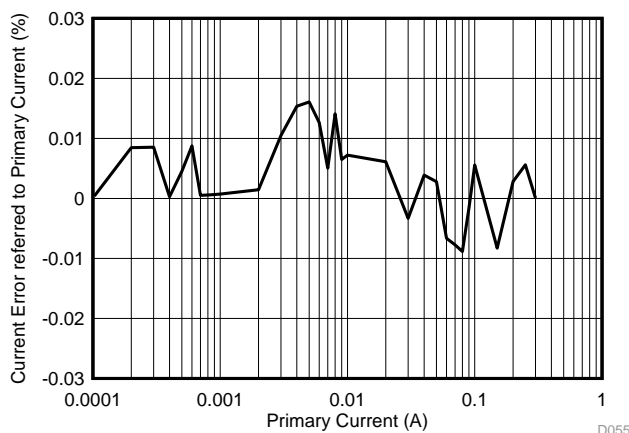

Figure 69. Current Error of a DRV421-Based Differential Closed-Loop Current Sensing Module

Typical Application (continued)

8.2.3 Using the DRV421 in ± 15 -V Sensor Applications

The DRV421 is designed for 3.3-V or 5-V nominal operation. To support a wider module current range, the device is also used in ± 15 -V application, as shown in Figure 70. In this application, an external regulator generates the 5-V supply for the DRV421. An additional external ± 15 -V power driver stage drives the compensation coil. These techniques allow the design of exceptionally precise and stable ± 15 -V current-sense modules.

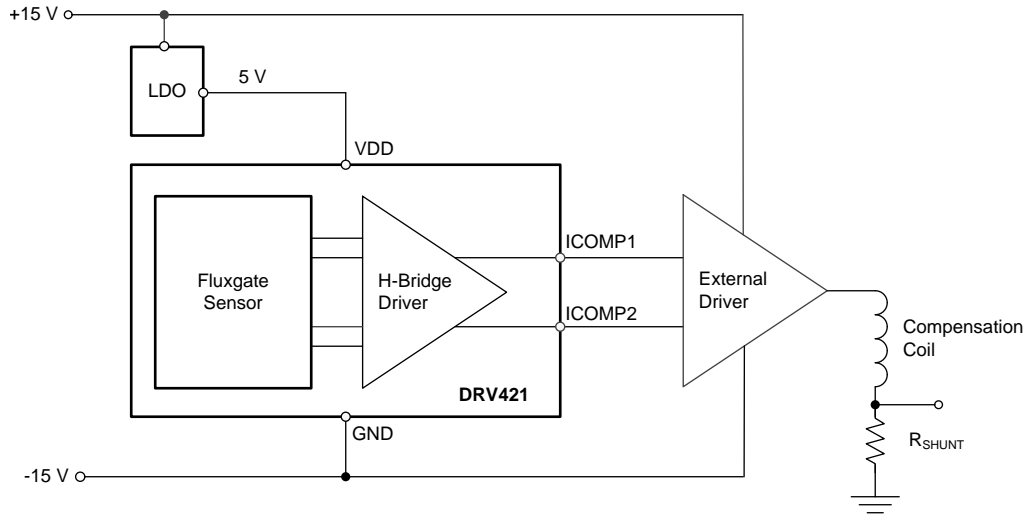

Figure 70. ± 15 -V Current-Sense Modules

9 Power-Supply Recommendations

9.1 Power-Supply Decoupling

Decouple both VDD pins of the DRV421 with 1- μ F X7R-type ceramic capacitors to the adjacent GND pin as illustrated in [Figure 71](#). For best performance, place both decoupling capacitors as close to the related power-supply pins as possible. Connect these capacitors to the power-supply source in a way that allows the current to flow through the pads of the decoupling capacitors.

9.2 Power-On Start Up and Brownout

Power-on is detected when the supply voltage exceeds 2.4 V at VDD pin. At this point, DRV421 initiates following start-up sequence:

1. Digital logic starts up and waits for 26 μ s for the supply to settle.
2. Fluxgate sensor powers up.
3. If fluxgate sensor saturation is detected, search function starts as described in the [Search Function](#) section.
4. If DEMAG pin is set high, demagnetization cycle starts as described in the [Magnetic Core Demagnetization](#) section.
5. The compensation loop is active after the demagnetization cycle, or 80 μ s after the supply voltage exceeds 2.4 V.

During this startup sequence, the ICOMP1 and ICOMP2 outputs are pulled low to prevent undesired signals on the compensation coil, and the ER pin is asserted low.

The DRV421 tests for low supply voltages with a brownout voltage level of 2.4 V. Use a power-supply source capable of supporting large current pulses driven by the DRV421, and low ESR bypass capacitors for stable supply voltage in the system. A supply drop below 2.4-V that lasts longer than 20 μ s generates a power-on reset; the device ignores shorter voltage drops. A voltage drop on the VDD pin to below 1.8 V immediately initiates a power-on reset. After the power supply returns to 2.4 V, the device initiates a start-up cycle, as described at the beginning of this section.

9.3 Power Dissipation

The thermally-enhanced, PowerPAD, WQFN package reduces the thermal impedance from junction to case. This package has a downset lead frame on which the die is mounted. The lead frame has an exposed thermal pad (PowerPAD) on the underside of the package, and provides a good thermal path for the heat dissipation.

The power dissipation on both linear outputs ICOMP1 and ICOMP2 is calculated with [Equation 8](#):

$$P_{D(\text{ICOMP})} = I_{\text{ICOMP}} \times (V_{\text{ICOMP}} - V_{\text{SUPPLY}})$$

where

- V_{SUPPLY} = voltage potential closer to V_{ICOMP} , V_{DD} , or GND (8)

CAUTION

Output short-circuit conditions are particularly critical for the H-bridge driver output pins ICOMP1 and ICOMP2. The full supply voltage occurs across the conducting transistor and the current is only limited by the current density limitation of the FET; permanent damage can occur. The DRV421 does not feature temperature protection or thermal shut-down.

9.3.1 Thermal Pad

Packages with an exposed thermal pad are specifically designed to provide excellent power dissipation, but board layout greatly influences the overall heat dissipation. Technical details are described in application report [SLMA002](#), *PowerPad Thermally Enhanced Package*, available for download at www.ti.com.

10 Layout

10.1 Layout Guidelines

The DRV421 unique, integrated fluxgate has a very high sensitivity to magnetic fields in order to enable design of a closed-loop current sensor with best-in-class precision and linearity. Observe proper PCB layout techniques because any current-conducting wire in the direct vicinity of the DRV421 generates a magnetic field that may distort measurements. Common passive components and some PCB plating materials contain ferromagnetic materials that are magnetizable. For best performance, use the following layout guidelines:

- Route current conducting wires in pairs: route a wire with an incoming supply current next to, or on top of its return current path. The opposite magnetic field polarity of these connection cancel each other. To facilitate this layout approach, the DRV421 positive and negative supply pins are located next to each other.
- Route the compensation coil connections close to each other as a pair to reduce coupling effects.
- Route currents parallel to the fluxgate sensor sensitivity axis as shown in [Figure 71](#). As a result, magnetic fields are perpendicular to the fluxgate sensitivity, and have limited impact.
- Vertical current flow (for example, through vias) generates a field in the fluxgate-sensitive direction. Minimize the number of vias in vicinity of the DRV421.
- Place all passive components (for example, decoupling capacitors and the shunt resistor) outside of the portion of the PCB that is inserted into the magnetic core gap. Use nonmagnetic components to prevent magnetizing effects.
- Do not use PCB trace finishes using nickel-gold plating because of the potential for magnetization.
- Connect all GND pins to a local ground plane.

Ferrite beads in series to the power-supply connection reduce interaction with other circuits powered from the same supply voltage source. However, to prevent influence of the magnetic fields if ferrite beads are used, do not place them next to the DRV421.

The reference output (REFOUT pin) refers to GND. Use a low-impedance and star-type connection to reduce the driver current and the fluxgate sensor current modulating the voltage drop on the ground track. The REFOUT and VOUT outputs are able to drive some capacitive load, but avoid large direct capacitive loading because of increased internal pulse currents. Given the wide bandwidth of the shunt sense amplifier, isolate large capacitive loads with a small series resistor.

Solder the exposed PowerPAD, on the bottom of the package to the ground layer because the PowerPAD is internally connected to the substrate that must be connected to the most-negative potential.

[Figure 71](#) illustrates a generic layout example that highlights the placement of components that are critical to the DRV421 performance. For specific layout examples, see [SLOU409](#), *DRV421EVM Users Guide*, and [TIDUA92](#), *TIPD196 Design Guide*.

10.2 Layout Example

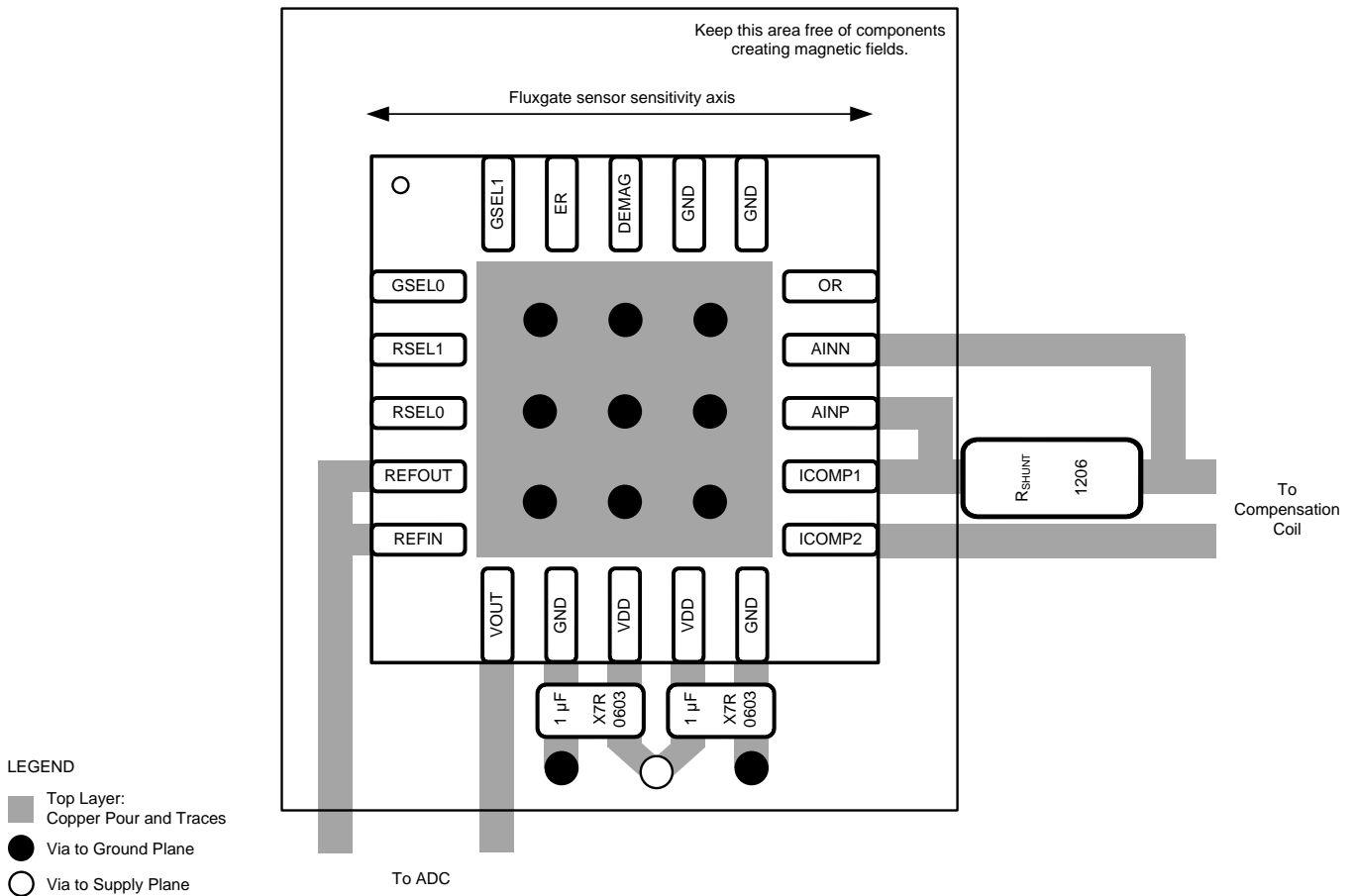

Figure 71. Generic Layout Example (Top View)

11 Device and Documentation Support

11.1 Documentation Support

11.1.1 Related Documentation

- DRV421EVM Users Guide, [SLOU409](#)
- TIPD196 Design Guide, [TIDUA92](#)
- *Designing with the DRV421: Closed Loop Current Sensor Specifications*, [SLOA223](#)
- *Designing with the DRV421: Control Loop Stability*, [SLOA224](#)

11.2 Community Resources

The following links connect to TI community resources. Linked contents are provided "AS IS" by the respective contributors. They do not constitute TI specifications and do not necessarily reflect TI's views; see TI's [Terms of Use](#).

TI E2E™ Online Community *TI's Engineer-to-Engineer (E2E) Community*. Created to foster collaboration among engineers. At [e2e.ti.com](#), you can ask questions, share knowledge, explore ideas and help solve problems with fellow engineers.

Design Support *TI's Design Support* Quickly find helpful E2E forums along with design support tools and contact information for technical support.

11.3 Trademarks

PowerPAD, E2E are trademarks of Texas Instruments.
All other trademarks are the property of their respective owners.

11.4 Electrostatic Discharge Caution



This integrated circuit can be damaged by ESD. Texas Instruments recommends that all integrated circuits be handled with appropriate precautions. Failure to observe proper handling and installation procedures can cause damage.

ESD damage can range from subtle performance degradation to complete device failure. Precision integrated circuits may be more susceptible to damage because very small parametric changes could cause the device not to meet its published specifications.

11.5 Glossary

[SLYZ022](#) — *TI Glossary*.

This glossary lists and explains terms, acronyms, and definitions.

12 Mechanical, Packaging, and Orderable Information

The following pages include mechanical, packaging, and orderable information. This information is the most current data available for the designated devices. This data is subject to change without notice and revision of this document. For browser-based versions of this data sheet, refer to the left-hand navigation.

PACKAGING INFORMATION

Orderable Device	Status (1)	Package Type	Package Drawing	Pins	Package Qty	Eco Plan (2)	Lead/Ball Finish (6)	MSL Peak Temp (3)	Op Temp (°C)	Device Marking (4/5)	Samples
DRV421RTJR	ACTIVE	QFN	RTJ	20	3000	Green (RoHS & no Sb/Br)	CU	Level-3-260C-168 HR	-40 to 125	-----> DRV421	Samples
DRV421RTJT	ACTIVE	QFN	RTJ	20	250	Green (RoHS & no Sb/Br)	CU	Level-3-260C-168 HR	-40 to 125	-----> DRV421	Samples

(1) The marketing status values are defined as follows:

ACTIVE: Product device recommended for new designs.

LIFEBUY: TI has announced that the device will be discontinued, and a lifetime-buy period is in effect.

NRND: Not recommended for new designs. Device is in production to support existing customers, but TI does not recommend using this part in a new design.

PREVIEW: Device has been announced but is not in production. Samples may or may not be available.

OBSOLETE: TI has discontinued the production of the device.

(2) Eco Plan - The planned eco-friendly classification: Pb-Free (RoHS), Pb-Free (RoHS Exempt), or Green (RoHS & no Sb/Br) - please check <http://www.ti.com/productcontent> for the latest availability information and additional product content details.

TBD: The Pb-Free/Green conversion plan has not been defined.

Pb-Free (RoHS): TI's terms "Lead-Free" or "Pb-Free" mean semiconductor products that are compatible with the current RoHS requirements for all 6 substances, including the requirement that lead not exceed 0.1% by weight in homogeneous materials. Where designed to be soldered at high temperatures, TI Pb-Free products are suitable for use in specified lead-free processes.

Pb-Free (RoHS Exempt): This component has a RoHS exemption for either 1) lead-based flip-chip solder bumps used between the die and package, or 2) lead-based die adhesive used between the die and leadframe. The component is otherwise considered Pb-Free (RoHS compatible) as defined above.

Green (RoHS & no Sb/Br): TI defines "Green" to mean Pb-Free (RoHS compatible), and free of Bromine (Br) and Antimony (Sb) based flame retardants (Br or Sb do not exceed 0.1% by weight in homogeneous material)

(3) MSL, Peak Temp. - The Moisture Sensitivity Level rating according to the JEDEC industry standard classifications, and peak solder temperature.

(4) There may be additional marking, which relates to the logo, the lot trace code information, or the environmental category on the device.

(5) Multiple Device Markings will be inside parentheses. Only one Device Marking contained in parentheses and separated by a "~" will appear on a device. If a line is indented then it is a continuation of the previous line and the two combined represent the entire Device Marking for that device.

(6) Lead/Ball Finish - Orderable Devices may have multiple material finish options. Finish options are separated by a vertical ruled line. Lead/Ball Finish values may wrap to two lines if the finish value exceeds the maximum column width.

Important Information and Disclaimer: The information provided on this page represents TI's knowledge and belief as of the date that it is provided. TI bases its knowledge and belief on information provided by third parties, and makes no representation or warranty as to the accuracy of such information. Efforts are underway to better integrate information from third parties. TI has taken and continues to take reasonable steps to provide representative and accurate information but may not have conducted destructive testing or chemical analysis on incoming materials and chemicals. TI and TI suppliers consider certain information to be proprietary, and thus CAS numbers and other limited information may not be available for release.

In no event shall TI's liability arising out of such information exceed the total purchase price of the TI part(s) at issue in this document sold by TI to Customer on an annual basis.

TAPE AND REEL INFORMATION



QUADRANT ASSIGNMENTS FOR PIN 1 ORIENTATION IN TAPE



*All dimensions are nominal

Device	Package Type	Package Drawing	Pins	SPQ	Reel Diameter (mm)	Reel Width W1 (mm)	A0 (mm)	B0 (mm)	K0 (mm)	P1 (mm)	W (mm)	Pin1 Quadrant
DRV421RTJR	QFN	RTJ	20	3000	330.0	12.4	4.25	4.25	1.15	8.0	12.0	Q2
DRV421RTJT	QFN	RTJ	20	250	180.0	12.4	4.25	4.25	1.15	8.0	12.0	Q2

TAPE AND REEL BOX DIMENSIONS



*All dimensions are nominal

Device	Package Type	Package Drawing	Pins	SPQ	Length (mm)	Width (mm)	Height (mm)
DRV421RTJR	QFN	RTJ	20	3000	367.0	367.0	35.0
DRV421RTJT	QFN	RTJ	20	250	210.0	185.0	35.0

MECHANICAL DATA

RTJ (S-PWQFN-N20)

PLASTIC QUAD FLATPACK NO-LEAD

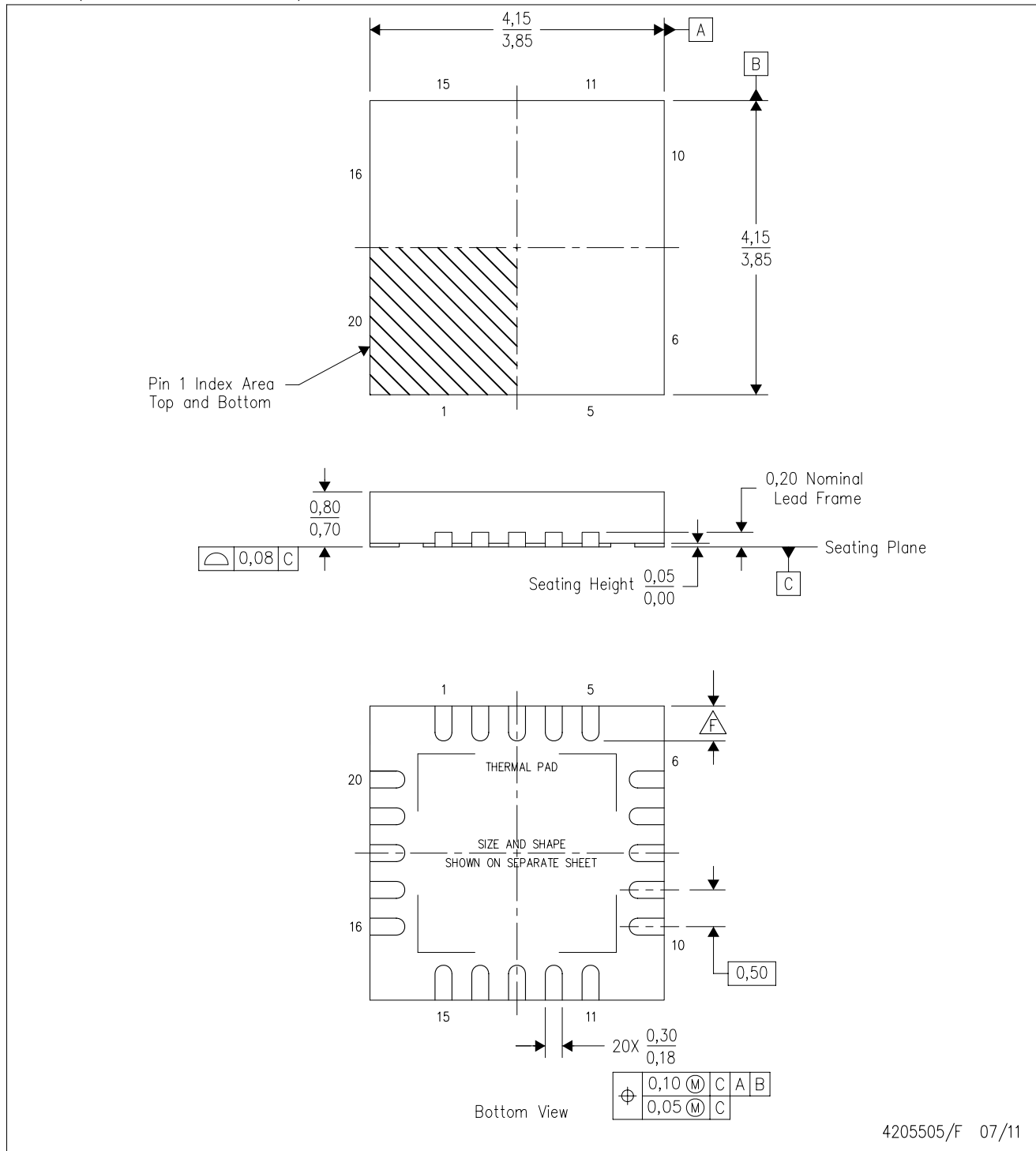

- NOTES:
- All linear dimensions are in millimeters. Dimensioning and tolerancing per ASME Y14.5-1994.
 - This drawing is subject to change without notice.
 - QFN (Quad Flatpack No-Lead) package configuration.
 - The package thermal pad must be soldered to the board for thermal and mechanical performance.
 - See the additional figure in the Product Data Sheet for details regarding the exposed thermal pad features and dimensions.
 - Check thermal pad mechanical drawing in the product datasheet for nominal lead length dimensions.

RTJ (S-PWQFN-N20)

PLASTIC QUAD FLATPACK NO-LEAD

THERMAL INFORMATION

This package incorporates an exposed thermal pad that is designed to be attached directly to an external heatsink. The thermal pad must be soldered directly to the printed circuit board (PCB). After soldering, the PCB can be used as a heatsink. In addition, through the use of thermal vias, the thermal pad can be attached directly to the appropriate copper plane shown in the electrical schematic for the device, or alternatively, can be attached to a special heatsink structure designed into the PCB. This design optimizes the heat transfer from the integrated circuit (IC).

For information on the Quad Flatpack No-Lead (QFN) package and its advantages, refer to Application Report, QFN/SON PCB Attachment, Texas Instruments Literature No. SLUA271. This document is available at www.ti.com.

The exposed thermal pad dimensions for this package are shown in the following illustration.

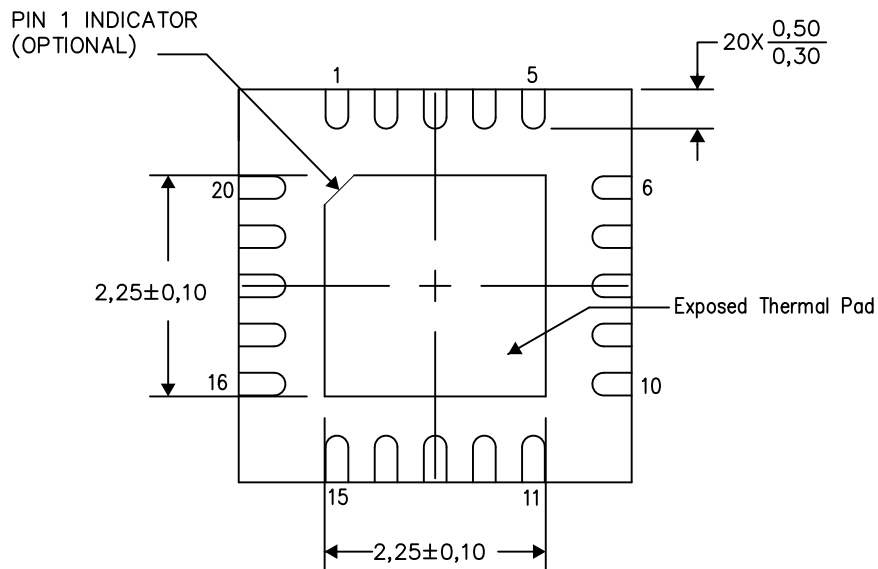

Bottom View

Exposed Thermal Pad Dimensions

4206256-8/V 05/15

NOTE: All linear dimensions are in millimeters

IMPORTANT NOTICE

Texas Instruments Incorporated and its subsidiaries (TI) reserve the right to make corrections, enhancements, improvements and other changes to its semiconductor products and services per JESD46, latest issue, and to discontinue any product or service per JESD48, latest issue. Buyers should obtain the latest relevant information before placing orders and should verify that such information is current and complete. All semiconductor products (also referred to herein as "components") are sold subject to TI's terms and conditions of sale supplied at the time of order acknowledgment.

TI warrants performance of its components to the specifications applicable at the time of sale, in accordance with the warranty in TI's terms and conditions of sale of semiconductor products. Testing and other quality control techniques are used to the extent TI deems necessary to support this warranty. Except where mandated by applicable law, testing of all parameters of each component is not necessarily performed.

TI assumes no liability for applications assistance or the design of Buyers' products. Buyers are responsible for their products and applications using TI components. To minimize the risks associated with Buyers' products and applications, Buyers should provide adequate design and operating safeguards.

TI does not warrant or represent that any license, either express or implied, is granted under any patent right, copyright, mask work right, or other intellectual property right relating to any combination, machine, or process in which TI components or services are used. Information published by TI regarding third-party products or services does not constitute a license to use such products or services or a warranty or endorsement thereof. Use of such information may require a license from a third party under the patents or other intellectual property of the third party, or a license from TI under the patents or other intellectual property of TI.

Reproduction of significant portions of TI information in TI data books or data sheets is permissible only if reproduction is without alteration and is accompanied by all associated warranties, conditions, limitations, and notices. TI is not responsible or liable for such altered documentation. Information of third parties may be subject to additional restrictions.

Resale of TI components or services with statements different from or beyond the parameters stated by TI for that component or service voids all express and any implied warranties for the associated TI component or service and is an unfair and deceptive business practice. TI is not responsible or liable for any such statements.

Buyer acknowledges and agrees that it is solely responsible for compliance with all legal, regulatory and safety-related requirements concerning its products, and any use of TI components in its applications, notwithstanding any applications-related information or support that may be provided by TI. Buyer represents and agrees that it has all the necessary expertise to create and implement safeguards which anticipate dangerous consequences of failures, monitor failures and their consequences, lessen the likelihood of failures that might cause harm and take appropriate remedial actions. Buyer will fully indemnify TI and its representatives against any damages arising out of the use of any TI components in safety-critical applications.

In some cases, TI components may be promoted specifically to facilitate safety-related applications. With such components, TI's goal is to help enable customers to design and create their own end-product solutions that meet applicable functional safety standards and requirements. Nonetheless, such components are subject to these terms.

No TI components are authorized for use in FDA Class III (or similar life-critical medical equipment) unless authorized officers of the parties have executed a special agreement specifically governing such use.

Only those TI components which TI has specifically designated as military grade or "enhanced plastic" are designed and intended for use in military/aerospace applications or environments. Buyer acknowledges and agrees that any military or aerospace use of TI components which have **not** been so designated is solely at the Buyer's risk, and that Buyer is solely responsible for compliance with all legal and regulatory requirements in connection with such use.

TI has specifically designated certain components as meeting ISO/TS16949 requirements, mainly for automotive use. In any case of use of non-designated products, TI will not be responsible for any failure to meet ISO/TS16949.

Products

Audio	www.ti.com/audio
Amplifiers	amplifier.ti.com
Data Converters	dataconverter.ti.com
DLP® Products	www.dlp.com
DSP	dsp.ti.com
Clocks and Timers	www.ti.com/clocks
Interface	interface.ti.com
Logic	logic.ti.com
Power Mgmt	power.ti.com
Microcontrollers	microcontroller.ti.com
RFID	www.ti-rfid.com
OMAP Applications Processors	www.ti.com/omap
Wireless Connectivity	www.ti.com/wirelessconnectivity

Applications

Automotive and Transportation	www.ti.com/automotive
Communications and Telecom	www.ti.com/communications
Computers and Peripherals	www.ti.com/computers
Consumer Electronics	www.ti.com/consumer-apps
Energy and Lighting	www.ti.com/energy
Industrial	www.ti.com/industrial
Medical	www.ti.com/medical
Security	www.ti.com/security
Space, Avionics and Defense	www.ti.com/space-avionics-defense
Video and Imaging	www.ti.com/video

TI E2E Community

e2e.ti.com