

LM2991 Negative Low-Dropout Adjustable Regulator

1 Features

- Output Voltage Adjustable from -3 V to -24 V , Typically -2 V to -25 V
- Output Current in Excess of 1 A
- Dropout Voltage Typically 0.6 V at 1-A Load
- Low Quiescent Current
- Internal Short Circuit Current Limit
- Internal Thermal Shutdown With Hysteresis
- TTL, CMOS Compatible $\overline{\text{ON}}/\text{OFF}$ Switch
- Functional Complement to the LM2941 Series

2 Applications

- Post Switcher Regulator
- Local, On-Card, Regulation
- Battery Operated Equipment
- Industrial
- Instrumentation

3 Description

The LM2991 is a low dropout adjustable negative regulator with a output voltage range between -3 V to -24 V . The LM2991 provides up to 1 A of load current and features a $\overline{\text{ON}}/\text{OFF}$ pin for remote shutdown capability.

The LM2991 uses new circuit design techniques to provide a low dropout voltage, low quiescent current and low temperature coefficient precision reference. The dropout voltage at 1-A load current is typically 0.6 V and an ensured worst-case maximum of 1 V over the entire operating temperature range. The quiescent current is typically 1 mA with a 1-A load current and an input-output voltage differential greater than 3 V . A unique circuit design of the internal bias supply limits the quiescent current to only 9 mA (typical) when the regulator is in the dropout mode ($V_{\text{OUT}} - V_{\text{IN}} \leq 3\text{ V}$).

The LM2991 is short-circuit proof, and thermal shutdown includes hysteresis to enhance the reliability of the device when inadvertently overloaded for extended periods. The LM2991 is available in 5-lead TO-220 and DDPAK/TO-263 packages and is rated for operation over the automotive temperature range of -40°C to $+125^{\circ}\text{C}$. Mil-Aero versions are also available.

Device Information⁽¹⁾

PART NUMBER	PACKAGE	BODY SIZE (NOM)
LM2991	DDPAK/TO-263 (5)	10.20 mm x 9.00 mm
	TO-220 (5)	14.99 mm x 10.16 mm

(1) For all available packages, see the orderable addendum at the end of the data sheet.

Typical Application

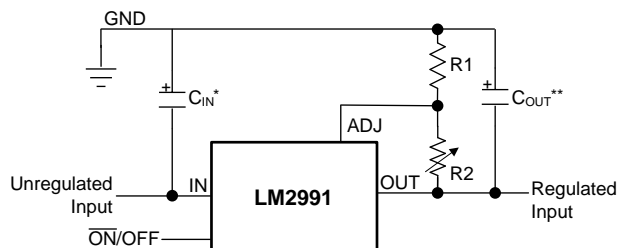

Copyright © 2016, Texas Instruments Incorporated

$$V_{\text{OUT}} = V_{\text{REF}} (1 + R2/R1)$$

* Required if the regulator is located further than 6 inches from the power supply filter capacitors. A $1\text{-}\mu\text{F}$ solid tantalum or a $10\text{-}\mu\text{F}$ aluminum electrolytic capacitor is recommended.

** Required for stability. Must be at least a $10\text{-}\mu\text{F}$ aluminum electrolytic or a $1\text{-}\mu\text{F}$ solid tantalum to maintain stability. May be increased without bound to maintain regulation during transients. Locate the capacitor as close as possible to the regulator. The equivalent series resistance (ESR) is critical, and should be less than 10Ω over the same operating temperature range as the regulator.



Table of Contents

1 Features 1 2 Applications 1 3 Description 1 4 Revision History 2 5 Pin Configuration and Functions 3 6 Specifications 4 6.1 Absolute Maximum Ratings 4 6.2 ESD Ratings..... 4 6.3 Recommended Operating Conditions 4 6.4 Thermal Information 4 6.5 Electrical Characteristics..... 5 6.6 Typical Characteristics 6 7 Detailed Description 9 7.1 Overview 9 7.2 Functional Block Diagram 9 7.3 Feature Description..... 9 7.4 Device Functional Modes..... 10	8 Application and Implementation 11 8.1 Application Information..... 11 8.2 Typical Application 11 9 Power Supply Recommendations 15 10 Layout 16 10.1 Layout Guidelines 16 10.2 Layout Example 16 11 Device and Documentation Support 17 11.1 Device Support 17 11.2 Related Documentation 17 11.3 Receiving Notification of Documentation Updates 17 11.4 Community Resources..... 17 11.5 Trademarks 17 11.6 Electrostatic Discharge Caution..... 18 11.7 Glossary 18 12 Mechanical, Packaging, and Orderable Information 18
---	---

4 Revision History

NOTE: Page numbers for previous revisions may differ from page numbers in the current version.

Changes from Revision H (June 2013) to Revision I	Page
<ul style="list-style-type: none"> • Added <i>Device Information</i> and <i>ESD Rating</i> tables, <i>Feature Description</i>, <i>Device Functional Modes</i>, <i>Application and Implementation</i>, <i>Power Supply Recommendations</i>, <i>Layout</i>, <i>Device and Documentation Support</i>, and <i>Mechanical, Packaging, and Orderable Information</i> sections; moved some curves to <i>Application Curves</i> section 1 • Changed footnote 4 of <i>Abs Max</i> table and footnote 1 to <i>Typical Characteristics</i> to eliminate obsolete thermal values for θ_{JA}; updated values are in <i>Thermal Information</i> 4 • Changed Figure 14 as previous thermal values have been updated 8 	
Changes from Revision G (April 2013) to Revision H	Page
<ul style="list-style-type: none"> • Changed layout of National Semiconductor data sheet to TI format..... 1 	1

5 Pin Configuration and Functions

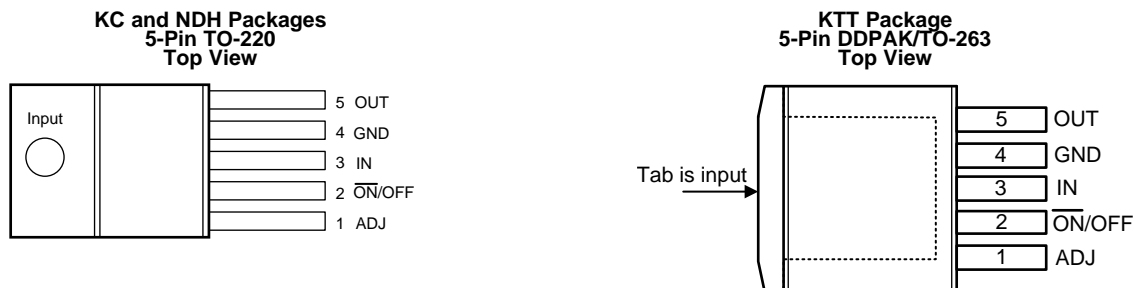

Pin Functions

PIN		I/O	DESCRIPTION
NO.	NAME		
1	ADJ	I	Feedback pin to the control loop for programming the output voltage.
2	ON/OFF	I	Logic high enable input
3	IN	I	Negative Input voltage. Internally connected directly to the thermal tab.
4	GND	—	Ground
5	OUT	O	Regulated output voltage
—	TAB	I	Negative Input voltage. Internally connected directly to the device pin 3. The thermal tab must be connected to a copper area on the PCB at the same potential as device pin 3 (IN) to assure thermal performance, or leave the thermal tab floating. Do NOT connect the thermal tab to any potential other than the same potential at device pin 3. Do NOT connect the thermal tab to ground.

6 Specifications

6.1 Absolute Maximum Ratings

over operating free-air temperature range (unless otherwise noted)⁽¹⁾⁽²⁾

	MIN	MAX	UNIT
Input voltage	-26	0.3	V
Power dissipation ⁽³⁾	Internally limited		
Storage temperature, T _{stg}	-65	150	°C

- (1) Stresses beyond those listed under *Absolute Maximum Ratings* may cause permanent damage to the device. These are stress ratings only, which do not imply functional operation of the device at these or any other conditions beyond those indicated under *Recommended Operating Conditions*. Exposure to absolute-maximum-rated conditions for extended periods may affect device reliability.
- (2) If Military/Aerospace specified devices are required, contact the Texas Instruments Sales Office/Distributors for availability and specifications.
- (3) The maximum power dissipation is a function of T_{J(MAX)}, R_{θJA}, and T_A. The maximum allowable power dissipation at any ambient temperature is P_D = (T_{J(MAX)} - T_A)/R_{θJA}. If this dissipation is exceeded, the die temperature will rise above 125°C, and the LM2991 will eventually go into thermal shutdown at a T_J of approximately 160°C. Refer to [Thermal Shutdown](#) for more details.

6.2 ESD Ratings

	VALUE	UNIT
V _(ESD) Electrostatic discharge Human-body model (HBM), per ANSI/ESDA/JEDEC JS-001 ⁽¹⁾	±2000	V

- (1) JEDEC document JEP155 states that 500-V HBM allows safe manufacturing with a standard ESD control process.

6.3 Recommended Operating Conditions

over operating free-air temperature range (unless otherwise noted)⁽¹⁾

	MIN	NOM	MAX	UNIT
Junction temperature, T _J	-40		125	°C
ON/OFF pin	0		5	V
Maximum input voltage (operational)	-26			V

- (1) Stresses beyond those listed under *Absolute Maximum Ratings* may cause permanent damage to the device. These are stress ratings only, which do not imply functional operation of the device at these or any other conditions beyond those indicated under *Recommended Operating Conditions*. Exposure to absolute-maximum-rated conditions for extended periods may affect device reliability.

6.4 Thermal Information

THERMAL METRIC ⁽¹⁾	LM2991			UNIT
	TO-263 (KTT)	TO-220 (NDH) ⁽²⁾	TO-220 (KC) ⁽²⁾	
	5 PINS	5 PINS	5 PINS	
R _{θJA} ⁽³⁾ Junction-to-ambient thermal resistance, High-K	27.8	54.4	56.4	°C/W
R _{θJC(top)} Junction-to-case (top) thermal resistance	41.4	30.1	40.0	°C/W
R _{θJB} Junction-to-board thermal resistance	10.9	33.2	38.6	°C/W
ψ _{JT} Junction-to-top characterization parameter	6.0	11.6	12.8	°C/W
ψ _{JB} Junction-to-board characterization parameter	10.6	36.2	35.3	°C/W
R _{θJC(bot)} Junction-to-case (bottom) thermal resistance	0.7	0.5	0.6	°C/W

- (1) For more information about traditional and new thermal metrics, see [Semiconductor and IC Package Thermal Metrics](#).
- (2) The TO-220 package is vertically mounted in center of a JEDEC High-K test board (JESD 51-7) with no additional heat sink attached. This is a through-hole package; this is NOT a surface-mount package.
- (3) Thermal resistance value R_{θJA} is based on the EIA/JEDEC High-K printed circuit board defined by JESD51-7 - *High Effective Thermal Conductivity Test Board for Leaded Surface Mount Packages*.

6.5 Electrical Characteristics

 $V_{IN} = -10\text{ V}$, $V_{OUT} = -3\text{ V}$, $I_{OUT} = 1\text{ A}$, $C_{OUT} = 47\text{ }\mu\text{F}$, $R1 = 2.7\text{ k}\Omega$, $T_J = 25^\circ\text{C}$, unless otherwise specified.

PARAMETER	TEST CONDITIONS	MIN	TYP ⁽¹⁾	MAX	UNIT
Reference voltage	$5\text{ mA} \leq I_{OUT} \leq 1\text{ A}$	-1.234	-1.210	-1.186	V
	$5\text{ mA} \leq I_{OUT} \leq 1\text{ A}$, $V_{OUT} - 1\text{ V} \geq V_{IN} > -26\text{ V}$ $-40^\circ\text{C} \leq T_J \leq 125^\circ\text{C}$	-1.27		-1.15	V
Output voltage (V_{OUT})			-2	-3	V
	$V_{IN} = -26\text{ V}$	-24	-25		V
Line regulation	$I_{OUT} = 5\text{ mA}$, $V_{OUT} - 1\text{ V} > V_{IN} > -26\text{ V}$		0.004	0.04	%/V
Load regulation	$50\text{ mA} \leq I_{OUT} \leq 1\text{ A}$		0.04%	0.4%	
Dropout voltage	$I_{OUT} = 0.1\text{ A}$, $\Delta V_{OUT} \leq 100\text{ mV}$		0.1	0.2	V
	$I_{OUT} = 0.1\text{ A}$, $\Delta V_{OUT} \leq 100\text{ mV}$ $-40^\circ\text{C} \leq T_J \leq 125^\circ\text{C}$			0.3	
	$I_{OUT} = 1\text{ A}$, $\Delta V_{OUT} \leq 100\text{ mV}$		0.6	0.8	V
	$I_{OUT} = 1\text{ A}$, $\Delta V_{OUT} \leq 100\text{ mV}$ $-40^\circ\text{C} \leq T_J \leq 125^\circ\text{C}$			1	
Quiescent current	$I_{OUT} \leq 1\text{ A}$		0.7		mA
	$I_{OUT} = 1\text{ A}$, $-40^\circ\text{C} \leq T_J \leq 125^\circ\text{C}$			5	
Dropout quiescent current	$V_{IN} = V_{OUT}$, $I_{OUT} \leq 1\text{ A}$		16	50	mA
Ripple rejection	$V_{\text{ripple}} = 1\text{ V}_{\text{RMS}}$, $f_{\text{ripple}} = 1\text{ kHz}$, $I_{OUT} = 5\text{ mA}$	50	60		dB
Output noise	10 Hz to 100 kHz, $I_{OUT} = 5\text{ mA}$		200	450	μV
$\overline{\text{ON}}$ /OFF input voltage	V_{OUT} : ON		1.2		V
	V_{OUT} : ON $-40^\circ\text{C} \leq T_J \leq 125^\circ\text{C}$			0.8	
	V_{OUT} : OFF		1.3		V
	V_{OUT} : OFF, $-40^\circ\text{C} \leq T_J \leq 125^\circ\text{C}$	2.4			
$\overline{\text{ON}}$ /OFF input current	$V_{\overline{\text{ON}}/\text{OFF}} = 0.8\text{ V}$, V_{OUT} : ON		0.1	10	μA
	$V_{\overline{\text{ON}}/\text{OFF}} = 2.4\text{ V}$, V_{OUT} : OFF		40	100	
Output leakage current	$V_{IN} = -26\text{ V}$, $V_{\overline{\text{ON}}/\text{OFF}} = 2.4\text{ V}$, $V_{OUT} = 0\text{ V}$		60	150	μA
Current limit	$V_{OUT} = 0\text{ V}$	1.5	2		A

(1) Typicals are at $T_J = 25^\circ\text{C}$ and represent the most likely parametric norm.

6.6 Typical Characteristics

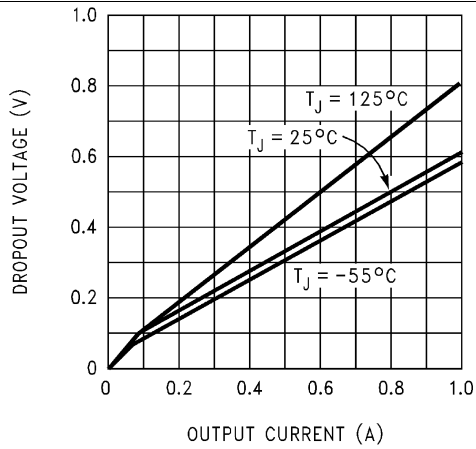

Figure 1. Dropout Voltage

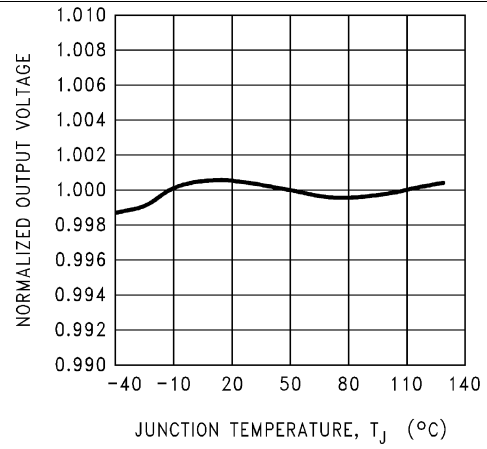

Figure 2. Normalized Output Voltage

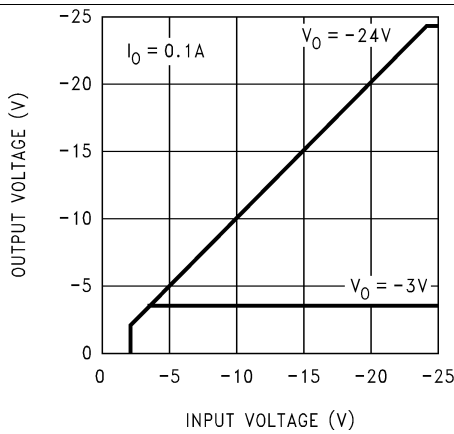

Figure 3. Output Voltage

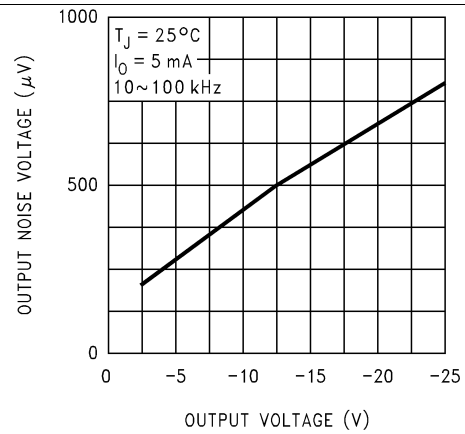

Figure 4. Output Noise Voltage

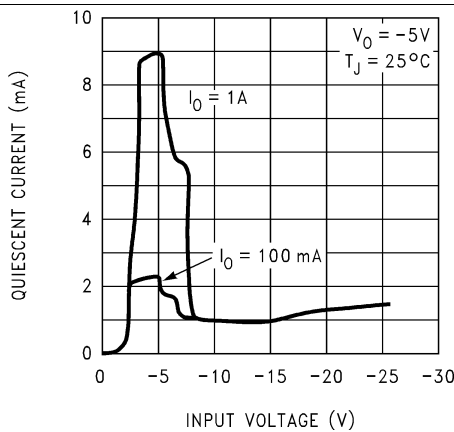

Figure 5. Quiescent Current

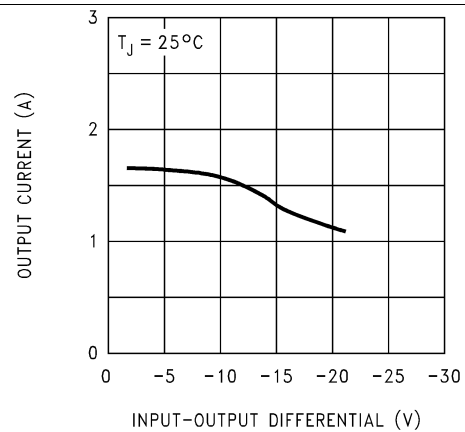

Figure 6. Maximum Output Current

Typical Characteristics (continued)

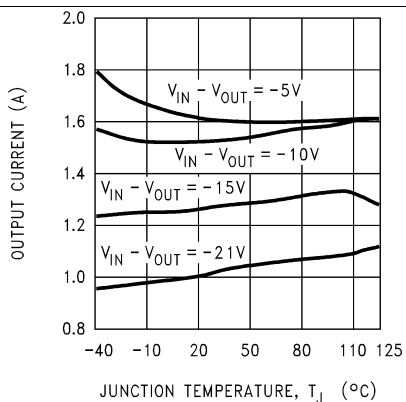

Figure 7. Maximum Output Current

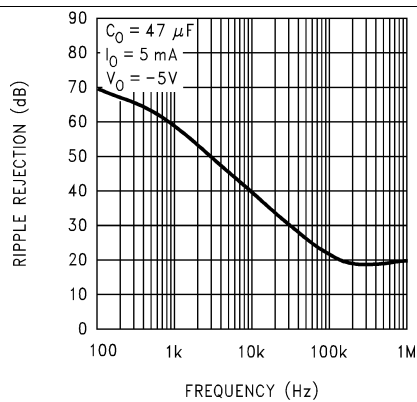

Figure 8. Ripple Rejection

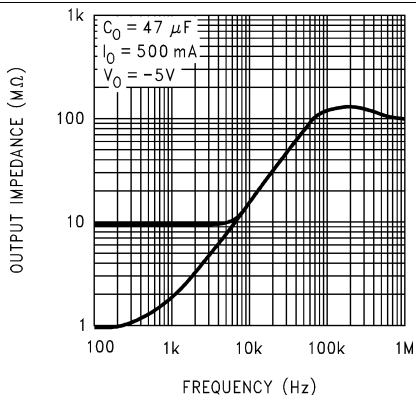

Figure 9. Output Impedance

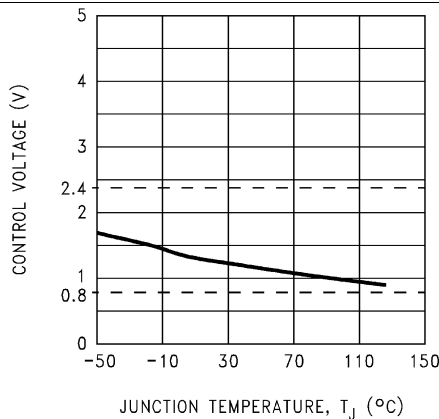

Figure 10. ON/OFF Control Voltage

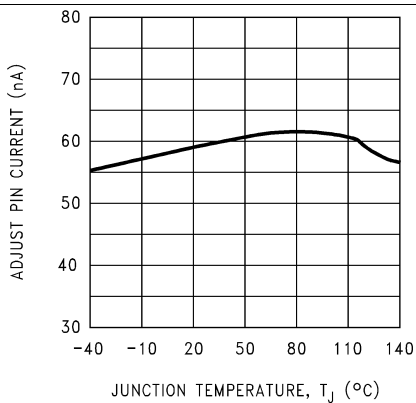

Figure 11. Adjust Pin Current

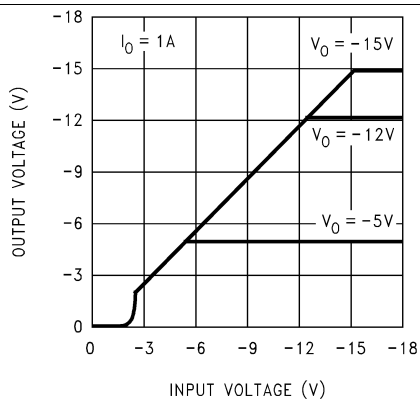

Figure 12. Low Voltage Behavior

Typical Characteristics (continued)

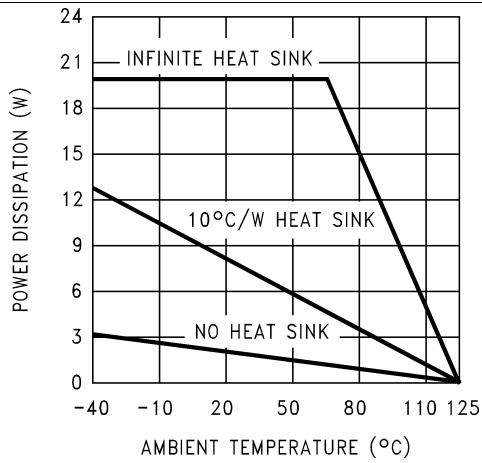

Figure 13. Maximum Power Dissipation (TO-220)

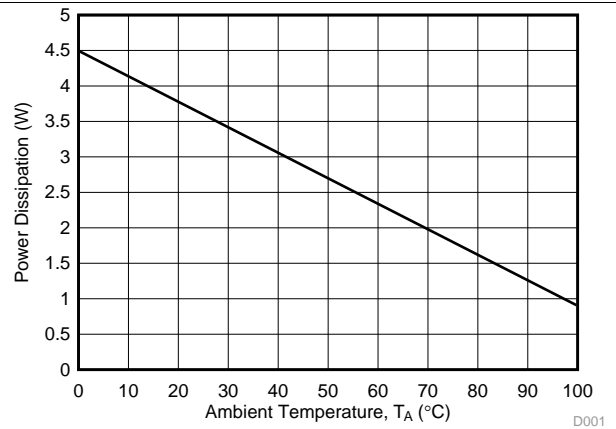

Figure 14. Maximum Power Dissipation (DDPAK/TO-263)

7.4 Device Functional Modes

7.4.1 Operation with $V_{\text{OUT(TARGET)}} - 5 \text{ V} \geq V_{\text{IN}} > -26 \text{ V}$

The device operates if the input voltage is within $V_{\text{OUT(TARGET)}} - 5 \text{ V}$ to -26 V range. At input voltages beyond the V_{IN} requirement, the devices do not operate correctly, and output voltage may not reach target value.

8 Application and Implementation

NOTE

Information in the following applications sections is not part of the TI component specification, and TI does not warrant its accuracy or completeness. TI's customers are responsible for determining suitability of components for their purposes. Customers should validate and test their design implementation to confirm system functionality.

8.1 Application Information

The LM2991 is a 1-A negative adjustable voltage regulator with an operating V_{IN} range of -6 V to -26 V , and a regulated V_{OUT} having 5% accuracy with a maximum rated I_{OUT} current of 1 A. Efficiency is defined by the ratio of output voltage to input voltage because the LM2991 is a linear voltage regulator. To achieve high efficiency, the dropout voltage ($V_{IN} - V_{OUT}$) must be as small as possible, thus requiring a very low dropout LDO.

Successfully implementing an LDO in an application depends on the application requirements. If the requirements are simply input voltage and output voltage, compliance specifications (such as internal power dissipation or stability) must be verified to ensure a solid design. If timing, start-up, noise, PSRR, or any other transient specification is required, the design becomes more challenging.

8.2 Typical Application

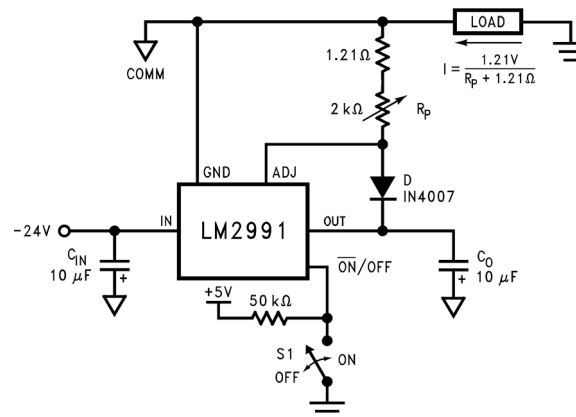

Copyright © 2016, Texas Instruments Incorporated

Figure 15. LM2991 Typical Application With Adjustable Current Sink

8.2.1 Design Requirements

For this design example, use the parameters listed in Table 1 as the input parameters.

Table 1. Design Parameters

DESIGN PARAMETER	DESIGN REQUIREMENT
Input voltage	-26 V to -5 V
Output voltage	-2 V to -25 V (typical)
Output current	up to 1 A

8.2.2 Detailed Design Procedure

At 400-mA loading, the dropout of the LM2991 has 1-V maximum dropout over temperature, thus an –5 V headroom is sufficient for operation over both input and output voltage accuracy. The efficiency of the LM2991 in this configuration is $V_{OUT} / V_{IN} = 50\%$.

To achieve the smallest form factor, the TO-263 (KTT) package is selected. Select input and output capacitors in accordance with the [External Capacitors](#) section. Aluminum capacitances of 470 μF for the input and 50- μF capacitors for the output are selected. With an efficiency of 50% and a 400-mA maximum load, the internal power dissipation is 2000 mW, which corresponds to 82.5°C junction temperature rise for the TO-263 package. With an 25°C ambient temperature, the junction temperature is at 107.5°C.

8.2.2.1 External Capacitors

The LM2991 regulator requires an output capacitor to maintain stability. The capacitor must be at least 10- μF aluminum electrolytic or 1- μF solid tantalum. The equivalent series resistance (ESR) of the output capacitor must be less than 10 Ω , or the zero added to the regulator frequency response by the ESR could reduce the phase margin, creating oscillations. An input capacitor, of at least 1- μF solid tantalum or 10- μF aluminum electrolytic, is also needed if the regulator is situated more than 6 inches from the input power supply filter.

8.2.2.1.1 Input Capacitor

TI recommends a solid tantalum or ceramic capacitor whose value is at least 1 μF , but an aluminum electrolytic ($\geq 10 \mu\text{F}$) may be used. However, aluminum electrolytic types should not be used in applications where the ambient temperature can drop below 0°C because their internal impedance increases significantly at cold temperatures.

8.2.2.1.2 Output Capacitor

The output capacitor must meet the ESR limits shown in [Figure 16](#), which means it must have an ESR between about 25 m Ω and 10 Ω .

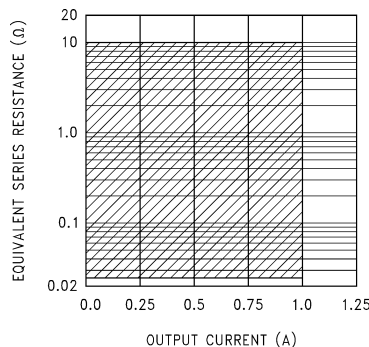

Figure 16. Output Capacitor ESR Range

A solid tantalum (value $\geq 1 \mu\text{F}$) is the best choice for the output capacitor. An aluminum electrolytic ($\geq 10 \mu\text{F}$) may be used if the ESR is in the stable range.

It should be noted that the ESR of a typical aluminum electrolytic will increase by as much as 50x as the temperature is reduced from 25°C down to –40°C, while a tantalum exhibits an ESR increase of about 2x over the same range. For this and other reasons, aluminum electrolytics should not be used in applications where low operating temperatures occur.

The lower stable ESR limit of 25 m Ω means that ceramic capacitors can not be used directly on the output of an LDO. A ceramic ($\geq 2.2 \mu\text{F}$) can be used on the output if some external resistance is placed in series with it (1 Ω recommended). Dielectric types X7R or X5R must be used if the temperature range of the application varies more than $\pm 25^\circ$ from ambient to assure the amount of capacitance is sufficient.

8.2.2.2 Ceramic Bypass Capacitors

Many designers place distributed ceramic capacitors whose value is in the range of 1000 pF to 0.1 μ F at the power input pins of the IC's across a circuit board. These can cause reduced phase margin or oscillations in LDO regulators.

The advent of multi-layer boards with dedicated power and ground planes has removed the trace inductance that (previously) provided the necessary "de-coupling" to shield the output of the LDO from the effects of bypass capacitors.

Avoid these capacitors, if possible; if ceramic bypass capacitors are used, keep them as far away from the LDO output as is practical.

8.2.2.3 Minimum Load

A minimum load current of 500 μ A is required for proper operation. The external resistor divider can provide the minimum load, with the resistor from the adjust pin to ground set to 2.4 k Ω .

8.2.2.4 Setting The Output Voltage

The output voltage of the LM2991 is set externally by a resistor divider using [Equation 1](#):

$$V_{OUT} = V_{REF} \times (1 + R_2/R_1) - (I_{ADJ} \times R_2)$$

where

- $V_{REF} = -1.21$ V (1)

The output voltage can be programmed within the range of -3 V to -24 V, typically an even greater range of -2 V to -25 V. The adjust pin current is about 60 nA, causing a slight error in the output voltage. However, using resistors lower than 100 k Ω makes the error due to the adjust pin current negligible. For example, neglecting the adjust pin current, and setting R2 to 100 k Ω and V_{OUT} to -5 V, results in an output voltage error of only 0.16%.

8.2.2.5 Power Dissipation

Knowing the device power dissipation and proper sizing of the thermal plane connected to the thermal tab is critical to ensuring reliable operation. Device power dissipation depends on input voltage, output voltage, and load conditions and can be calculated with [Equation 2](#).

$$P_{D(MAX)} = (V_{IN(MAX)} - V_{OUT}) \times I_{OUT} \quad (2)$$

Power dissipation can be minimized, and greater efficiency can be achieved, by using the lowest available voltage drop option that would still be greater than the dropout voltage (V_{DO}). However, keep in mind that higher voltage drops result in better dynamic (that is, PSRR and transient) performance.

Power dissipation and junction temperature are most often related by the junction-to-ambient thermal resistance ($R_{\theta JA}$) of the combined PCB and device package and the temperature of the ambient air (T_A), according to [Equation 3](#) or [Equation 4](#):

$$T_{J(MAX)} = T_{A(MAX)} + (R_{\theta JA} \times P_{D(MAX)}) \quad (3)$$

$$P_{D(MAX)} = (T_{J(MAX)} - T_{A(MAX)}) / R_{\theta JA} \quad (4)$$

Unfortunately, this $R_{\theta JA}$ is highly dependent on the heat-spreading capability of the particular PCB design, and therefore varies according to the total copper area, copper weight, and location of the planes. The $R_{\theta JA}$ recorded in [Thermal Information](#) is determined by the specific EIA/JEDEC JESD51-7 standard for PCB and copper-spreading area, and is to be used only as a relative measure of package thermal performance. For a well-designed thermal layout, $R_{\theta JA}$ is actually the sum of the package junction-to-case (bottom) thermal resistance ($R_{\theta JCbot}$) plus the thermal resistance contribution by the PCB copper area acting as a heat sink.

8.2.2.6 Estimating Junction Temperature

The EIA/JEDEC standard recommends the use of psi (Ψ) thermal characteristics to estimate the junction temperatures of surface mount devices on a typical PCB board application. These characteristics are not true thermal resistance values, but rather package specific thermal characteristics that offer practical and relative means of estimating junction temperatures. These psi metrics are determined to be significantly independent of copper-spreading area. The key thermal characteristics (Ψ_{JT} and Ψ_{JB}) are given in [Thermal Information](#) and are used in accordance with [Equation 5](#) or [Equation 6](#).

$$T_{J(MAX)} = T_{TOP} + (\Psi_{JT} \times P_{D(MAX)})$$

where

- $P_{D(MAX)}$ is explained in [Equation 4](#)
- T_{TOP} is the temperature measured at the center-top of the device package. (5)

$$T_{J(MAX)} = T_{BOARD} + (\Psi_{JB} \times P_{D(MAX)})$$

where

- $P_{D(MAX)}$ is explained in [Equation 4](#)
- T_{BOARD} is the PCB surface temperature measured 1-mm from the device package and centered on the package edge. (6)

For more information about the thermal characteristics Ψ_{JT} and Ψ_{JB} , see [Semiconductor and IC Package Thermal Metrics](#); for more information about measuring T_{TOP} and T_{BOARD} , see [Using New Thermal Metrics](#); and for more information about the EIA/JEDEC JESD51 PCB used for validating $R_{\theta JA}$, see [Thermal Characteristics of Linear and Logic Packages Using JEDEC PCB Designs](#). These application notes are available at www.ti.com.

8.2.3 Application Curves

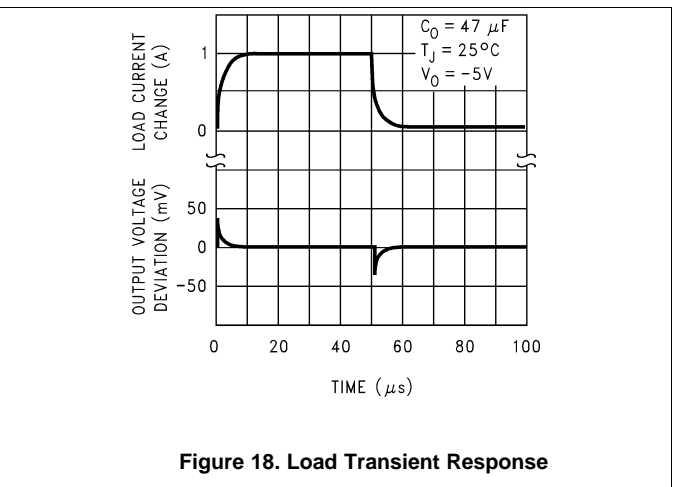
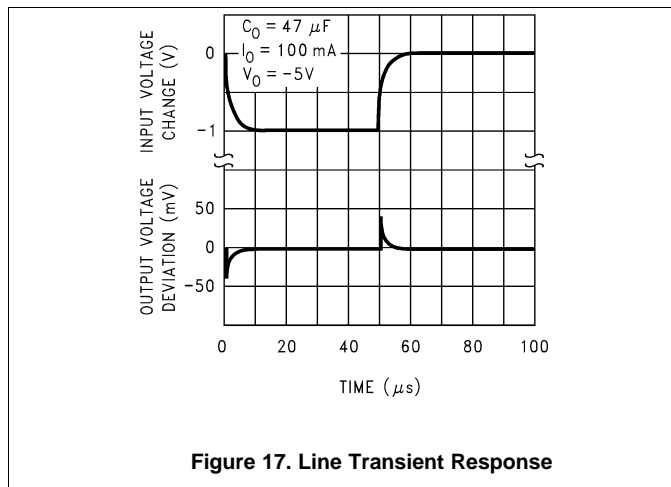

8.2.4 Additional Application Circuits

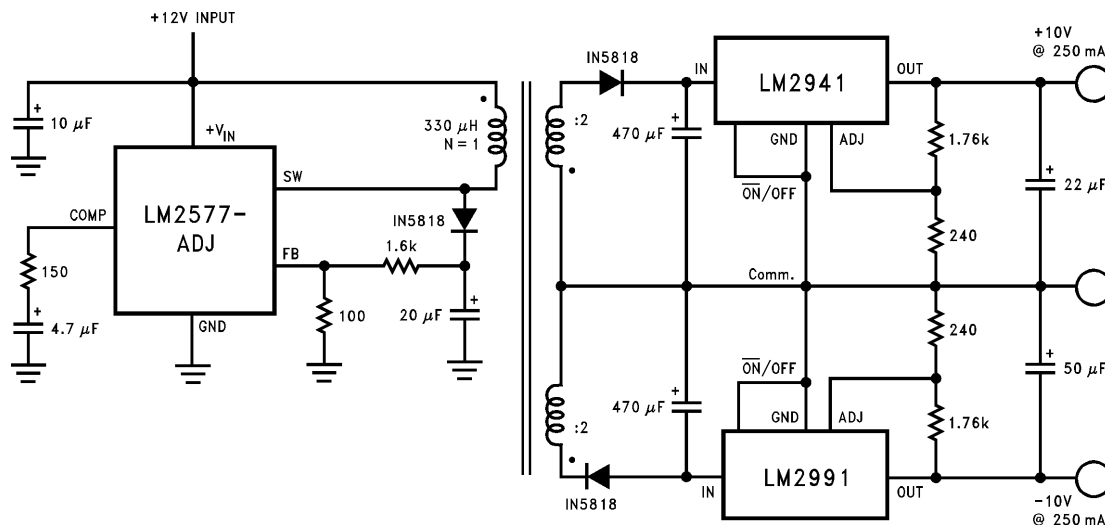

Figure 19. Fully Isolated Post-Switcher Regulator

9 Power Supply Recommendations

The LM2991 is designed to operate from an input voltage supply range between -6 V and -26 V. The input voltage range must provide adequate headroom in order for the device to have a regulated output. This input supply must be well regulated.

10 Layout

10.1 Layout Guidelines

The dynamic performance of the LM2991 is dependent on the layout of the PCB. PCB layout practices that are adequate for typical LDOs may degrade the PSRR, noise, or transient performance of the device. Best performance is achieved by placing C_{IN} and C_{OUT} on the same side of the PCB as the LM2991, and as close as is practical to the package. The ground connections for C_{IN} and C_{OUT} must be back to the LM2991 GND pin using as wide and short of a copper trace as is practical.

Good PC layout practices must be used or instability can be induced because of ground loops and voltage drops. The input and output capacitors must be directly connected to the IN, OUT, and GND pins of the LM2991 using traces which do not have other currents flowing in them (Kelvin connect). The best way to do this is to lay out C_{IN} and C_{OUT} near the device with short traces to the IN, OUT, and GND pins. The regulator ground pin must be connected to the external circuit ground so that the regulator and its capacitors have a single-point ground.

Stability problems have been seen in applications where vias to an internal ground plane were used at the ground points of the LM2991 device and the input and output capacitors. This was caused by varying ground potentials at these nodes resulting from current flowing through the ground plane. Using a single point ground technique for the regulator and its capacitors fixed the problem.

Because high current flows through the traces going into the IN pin and coming from the OUT pin, Kelvin connect the capacitor leads to these pins so there is no voltage drop in series with the input and output capacitors.

10.2 Layout Example

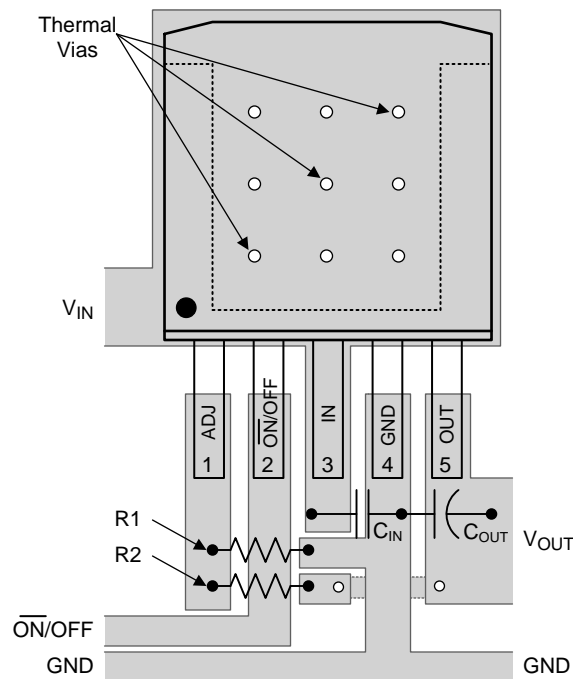

Figure 20. LM2991 TO-263 Board Layout

11 Device and Documentation Support

11.1 Device Support

11.1.1 Device Nomenclature

Dropout Voltage: The input-output voltage differential at which the circuit ceases to regulate against further reduction in input voltage. Measured when the output voltage has dropped 100 mV from the nominal value obtained at ($V_{OUT} + 5$ V) input, dropout voltage is dependent upon load current and junction temperature.

Input Voltage: The DC voltage applied to the input terminals with respect to ground.

Input-Output Differential: The voltage difference between the unregulated input voltage and the regulated output voltage for which the regulator will operate.

Line Regulation: The change in output voltage for a change in the input voltage. The measurement is made under conditions of low dissipation or by using pulse techniques such that the average chip temperature is not significantly affected.

Load Regulation: The change in output voltage for a change in load current at constant chip temperature.

Long Term Stability: Output voltage stability under accelerated life-test conditions after 1000 hours with maximum rated voltage and junction temperature.

Output Noise Voltage: The rms AC voltage at the output, with constant load and no input ripple, measured over a specified frequency range.

Quiescent Current: That part of the positive input current that does not contribute to the positive load current. The regulator ground lead current.

Ripple Rejection: The ratio of the peak-to-peak input ripple voltage to the peak-to-peak output ripple voltage.

Temperature Stability of V_{OUT} : The percentage change in output voltage for a thermal variation from room temperature to either temperature extreme.

11.2 Related Documentation

For additional information, see the following:

- [Semiconductor and IC Package Thermal Metrics](#)
- [Using New Thermal Metrics](#)
- [Thermal Characteristics of Linear and Logic Packages Using JEDEC PCB Designs](#)

11.3 Receiving Notification of Documentation Updates

To receive notification of documentation updates, navigate to the device product folder on ti.com. In the upper right corner, click on *Alert me* to register and receive a weekly digest of any product information that has changed. For change details, review the revision history included in any revised document.

11.4 Community Resources

The following links connect to TI community resources. Linked contents are provided "AS IS" by the respective contributors. They do not constitute TI specifications and do not necessarily reflect TI's views; see TI's [Terms of Use](#).

TI E2E™ Online Community *TI's Engineer-to-Engineer (E2E) Community*. Created to foster collaboration among engineers. At e2e.ti.com, you can ask questions, share knowledge, explore ideas and help solve problems with fellow engineers.

Design Support *TI's Design Support* Quickly find helpful E2E forums along with design support tools and contact information for technical support.

11.5 Trademarks

E2E is a trademark of Texas Instruments.

11.5 Trademarks (continued)

All other trademarks are the property of their respective owners.

11.6 Electrostatic Discharge Caution



These devices have limited built-in ESD protection. The leads should be shorted together or the device placed in conductive foam during storage or handling to prevent electrostatic damage to the MOS gates.

11.7 Glossary





[SLYZ022](#) — *TI Glossary*.

This glossary lists and explains terms, acronyms, and definitions.

12 Mechanical, Packaging, and Orderable Information

The following pages include mechanical, packaging, and orderable information. This information is the most current data available for the designated devices. This data is subject to change without notice and revision of this document. For browser-based versions of this data sheet, refer to the left-hand navigation.

PACKAGING INFORMATION

Orderable Device	Status (1)	Package Type	Package Drawing	Pins	Package Qty	Eco Plan (2)	Lead/Ball Finish (6)	MSL Peak Temp (3)	Op Temp (°C)	Device Marking (4/5)	Samples
LM2991 MWC	ACTIVE	WAFERSALE	YS	0	1	Green (RoHS & no Sb/Br)	Call TI	Level-1-NA-UNLIM	-40 to 85		
LM2991S	NRND	DDPAK/ TO-263	KTT	5	45	TBD	Call TI	Call TI	-40 to 125	LM2991S P+	
LM2991S/NOPB	ACTIVE	DDPAK/ TO-263	KTT	5	45	Pb-Free (RoHS Exempt)	CU SN	Level-3-245C-168 HR	-40 to 125	LM2991S P+	
LM2991SX	NRND	DDPAK/ TO-263	KTT	5	500	TBD	Call TI	Call TI	-40 to 125	LM2991S P+	
LM2991SX/NOPB	ACTIVE	DDPAK/ TO-263	KTT	5	500	Pb-Free (RoHS Exempt)	CU SN	Level-3-245C-168 HR	-40 to 125	LM2991S P+	
LM2991T	NRND	TO-220	KC	5	45	TBD	Call TI	Call TI	-40 to 125	LM2991T P+	
LM2991T/LB03	NRND	TO-220	NDH	5	45	TBD	Call TI	Call TI		LM2991T P+	
LM2991T/LF03	ACTIVE	TO-220	NDH	5	45	Pb-Free (RoHS Exempt)	CU SN	Level-1-NA-UNLIM		LM2991T P+	
LM2991T/NOPB	ACTIVE	TO-220	KC	5	45	Pb-Free (RoHS Exempt)	CU SN	Level-1-NA-UNLIM	-40 to 125	LM2991T P+	

(1) The marketing status values are defined as follows:

ACTIVE: Product device recommended for new designs.

LIFEBUY: TI has announced that the device will be discontinued, and a lifetime-buy period is in effect.

NRND: Not recommended for new designs. Device is in production to support existing customers, but TI does not recommend using this part in a new design.

PREVIEW: Device has been announced but is not in production. Samples may or may not be available.

OBSOLETE: TI has discontinued the production of the device.

(2) Eco Plan - The planned eco-friendly classification: Pb-Free (RoHS), Pb-Free (RoHS Exempt), or Green (RoHS & no Sb/Br) - please check <http://www.ti.com/productcontent> for the latest availability information and additional product content details.

TBD: The Pb-Free/Green conversion plan has not been defined.

Pb-Free (RoHS): TI's terms "Lead-Free" or "Pb-Free" mean semiconductor products that are compatible with the current RoHS requirements for all 6 substances, including the requirement that lead not exceed 0.1% by weight in homogeneous materials. Where designed to be soldered at high temperatures, TI Pb-Free products are suitable for use in specified lead-free processes.

Pb-Free (RoHS Exempt): This component has a RoHS exemption for either 1) lead-based flip-chip solder bumps used between the die and package, or 2) lead-based die adhesive used between the die and leadframe. The component is otherwise considered Pb-Free (RoHS compatible) as defined above.

Green (RoHS & no Sb/Br): TI defines "Green" to mean Pb-Free (RoHS compatible), and free of Bromine (Br) and Antimony (Sb) based flame retardants (Br or Sb do not exceed 0.1% by weight in homogeneous material)

- (3) MSL, Peak Temp. - The Moisture Sensitivity Level rating according to the JEDEC industry standard classifications, and peak solder temperature.
- (4) There may be additional marking, which relates to the logo, the lot trace code information, or the environmental category on the device.
- (5) Multiple Device Markings will be inside parentheses. Only one Device Marking contained in parentheses and separated by a "-" will appear on a device. If a line is indented then it is a continuation of the previous line and the two combined represent the entire Device Marking for that device.
- (6) Lead/Ball Finish - Orderable Devices may have multiple material finish options. Finish options are separated by a vertical ruled line. Lead/Ball Finish values may wrap to two lines if the finish value exceeds the maximum column width.

Important Information and Disclaimer:The information provided on this page represents TI's knowledge and belief as of the date that it is provided. TI bases its knowledge and belief on information provided by third parties, and makes no representation or warranty as to the accuracy of such information. Efforts are underway to better integrate information from third parties. TI has taken and continues to take reasonable steps to provide representative and accurate information but may not have conducted destructive testing or chemical analysis on incoming materials and chemicals. TI and TI suppliers consider certain information to be proprietary, and thus CAS numbers and other limited information may not be available for release.

In no event shall TI's liability arising out of such information exceed the total purchase price of the TI part(s) at issue in this document sold by TI to Customer on an annual basis.

TAPE AND REEL INFORMATION

QUADRANT ASSIGNMENTS FOR PIN 1 ORIENTATION IN TAPE

*All dimensions are nominal

Device	Package Type	Package Drawing	Pins	SPQ	Reel Diameter (mm)	Reel Width W1 (mm)	A0 (mm)	B0 (mm)	K0 (mm)	P1 (mm)	W (mm)	Pin1 Quadrant
LM2991SX	DDPAK/ TO-263	KTT	5	500	330.0	24.4	10.75	14.85	5.0	16.0	24.0	Q2
LM2991SX/NOPB	DDPAK/ TO-263	KTT	5	500	330.0	24.4	10.75	14.85	5.0	16.0	24.0	Q2

TAPE AND REEL BOX DIMENSIONS

*All dimensions are nominal

Device	Package Type	Package Drawing	Pins	SPQ	Length (mm)	Width (mm)	Height (mm)
LM2991SX	DDPAK/TO-263	KTT	5	500	367.0	367.0	45.0
LM2991SX/NOPB	DDPAK/TO-263	KTT	5	500	367.0	367.0	45.0

NDH0005D



T05D (REV A)

KTT0005B



CONTROLLING DIMENSION IS INCH
 VALUES IN [] ARE MILLIMETERS
 DIMENSIONS IN () FOR REFERENCE ONLY

TS5B (Rev D)

KC (R-PSFM-T5)

PLASTIC FLANGE-MOUNT PACKAGE

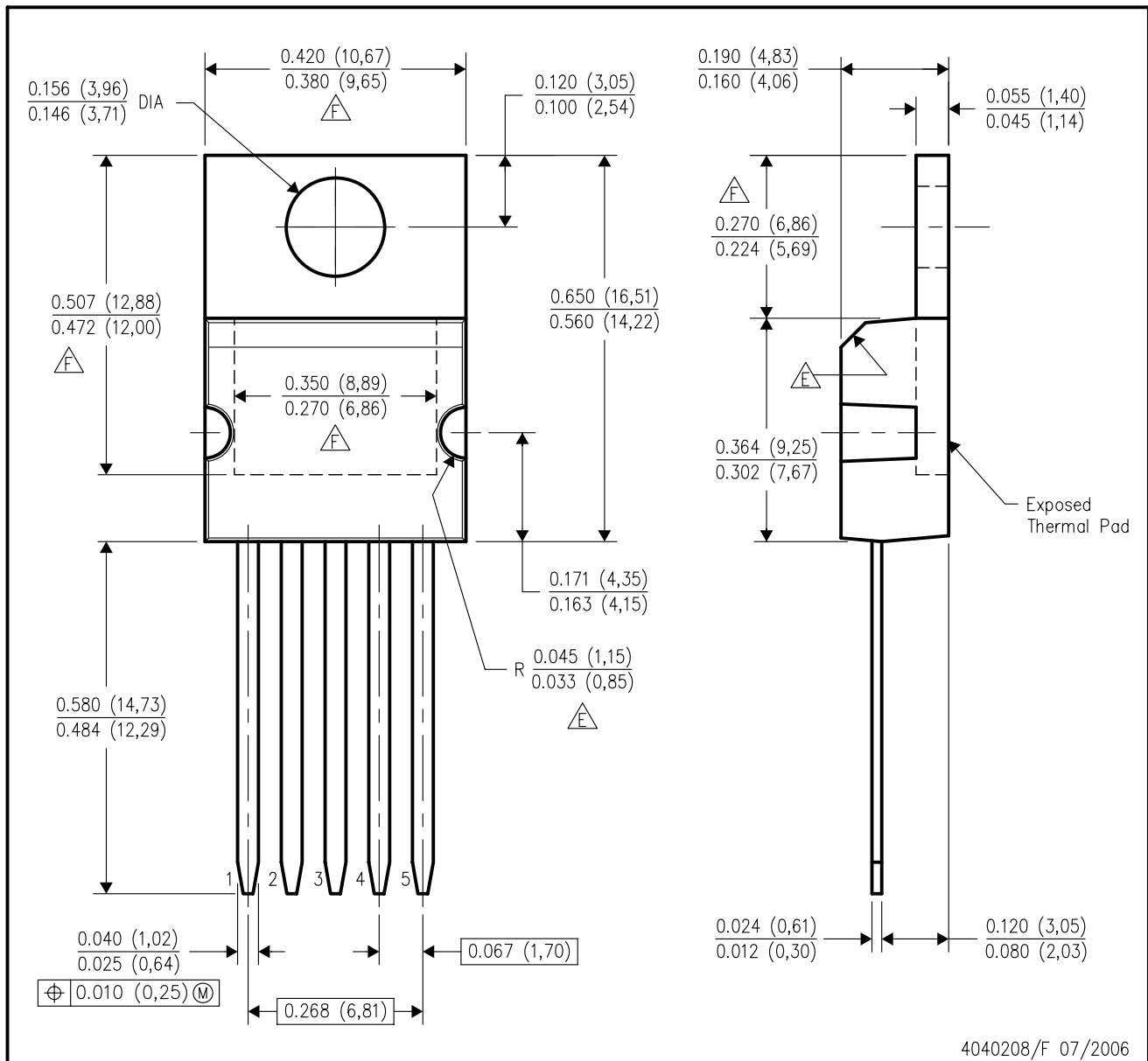

- NOTES:
- A. All linear dimensions are in inches (millimeters).
 - B. This drawing is subject to change without notice.
 - C. All lead dimensions apply before solder dip.
 - D. The center lead is in electrical contact with the mounting tab.
 - ⚠ These features are optional.
 - ⚠ Thermal pad contour optional within these dimensions.

IMPORTANT NOTICE

Texas Instruments Incorporated and its subsidiaries (TI) reserve the right to make corrections, enhancements, improvements and other changes to its semiconductor products and services per JESD46, latest issue, and to discontinue any product or service per JESD48, latest issue. Buyers should obtain the latest relevant information before placing orders and should verify that such information is current and complete. All semiconductor products (also referred to herein as "components") are sold subject to TI's terms and conditions of sale supplied at the time of order acknowledgment.

TI warrants performance of its components to the specifications applicable at the time of sale, in accordance with the warranty in TI's terms and conditions of sale of semiconductor products. Testing and other quality control techniques are used to the extent TI deems necessary to support this warranty. Except where mandated by applicable law, testing of all parameters of each component is not necessarily performed.

TI assumes no liability for applications assistance or the design of Buyers' products. Buyers are responsible for their products and applications using TI components. To minimize the risks associated with Buyers' products and applications, Buyers should provide adequate design and operating safeguards.

TI does not warrant or represent that any license, either express or implied, is granted under any patent right, copyright, mask work right, or other intellectual property right relating to any combination, machine, or process in which TI components or services are used. Information published by TI regarding third-party products or services does not constitute a license to use such products or services or a warranty or endorsement thereof. Use of such information may require a license from a third party under the patents or other intellectual property of the third party, or a license from TI under the patents or other intellectual property of TI.

Reproduction of significant portions of TI information in TI data books or data sheets is permissible only if reproduction is without alteration and is accompanied by all associated warranties, conditions, limitations, and notices. TI is not responsible or liable for such altered documentation. Information of third parties may be subject to additional restrictions.

Resale of TI components or services with statements different from or beyond the parameters stated by TI for that component or service voids all express and any implied warranties for the associated TI component or service and is an unfair and deceptive business practice. TI is not responsible or liable for any such statements.

Buyer acknowledges and agrees that it is solely responsible for compliance with all legal, regulatory and safety-related requirements concerning its products, and any use of TI components in its applications, notwithstanding any applications-related information or support that may be provided by TI. Buyer represents and agrees that it has all the necessary expertise to create and implement safeguards which anticipate dangerous consequences of failures, monitor failures and their consequences, lessen the likelihood of failures that might cause harm and take appropriate remedial actions. Buyer will fully indemnify TI and its representatives against any damages arising out of the use of any TI components in safety-critical applications.

In some cases, TI components may be promoted specifically to facilitate safety-related applications. With such components, TI's goal is to help enable customers to design and create their own end-product solutions that meet applicable functional safety standards and requirements. Nonetheless, such components are subject to these terms.

No TI components are authorized for use in FDA Class III (or similar life-critical medical equipment) unless authorized officers of the parties have executed a special agreement specifically governing such use.

Only those TI components which TI has specifically designated as military grade or "enhanced plastic" are designed and intended for use in military/aerospace applications or environments. Buyer acknowledges and agrees that any military or aerospace use of TI components which have **not** been so designated is solely at the Buyer's risk, and that Buyer is solely responsible for compliance with all legal and regulatory requirements in connection with such use.

TI has specifically designated certain components as meeting ISO/TS16949 requirements, mainly for automotive use. In any case of use of non-designated products, TI will not be responsible for any failure to meet ISO/TS16949.

Products

Audio	www.ti.com/audio
Amplifiers	amplifier.ti.com
Data Converters	dataconverter.ti.com
DLP® Products	www.dlp.com
DSP	dsp.ti.com
Clocks and Timers	www.ti.com/clocks
Interface	interface.ti.com
Logic	logic.ti.com
Power Mgmt	power.ti.com
Microcontrollers	microcontroller.ti.com
RFID	www.ti-rfid.com
OMAP Applications Processors	www.ti.com/omap
Wireless Connectivity	www.ti.com/wirelessconnectivity

Applications

Automotive and Transportation	www.ti.com/automotive
Communications and Telecom	www.ti.com/communications
Computers and Peripherals	www.ti.com/computers
Consumer Electronics	www.ti.com/consumer-apps
Energy and Lighting	www.ti.com/energy
Industrial	www.ti.com/industrial
Medical	www.ti.com/medical
Security	www.ti.com/security
Space, Avionics and Defense	www.ti.com/space-avionics-defense
Video and Imaging	www.ti.com/video

TI E2E Community

e2e.ti.com