

Stereo Audio Codec with USB Interface, Single-Ended Analog Input/Output, and S/PDIF

Check for Samples: [PCM2906C](#)

FEATURES

- **On-Chip USB Interface:**
 - With Full-Speed Transceivers
 - Fully Compliant with USB 2.0 Specification
 - Certified by USB-IF
 - USB Adaptive Mode for Playback
 - USB Asynchronous Mode for Record
 - Bus Powered
- **16-Bit Delta-Sigma ADC and DAC**
- **Sampling Rate:**
 - DAC: 32, 44.1, 48 kHz
 - ADC: 8, 11.025, 16, 22.05, 32, 44.1, 48 kHz
- **On-Chip Clock Generator with Single 12-MHz Clock Source**
- **S/PDIF Input/Output**
- **Single Power Supply:**
 - 5 V Typical (V_{BUS})
- **Stereo ADC:**
 - **Analog Performance at $V_{BUS} = 5$ V:**
 - THD+N = 0.01%
 - SNR = 89 dB
 - Dynamic Range = 89 dB
 - **Decimation Digital Filter:**
 - Passband Ripple = ± 0.05 dB
 - Stop-Band Attenuation = -65 dB
 - **Single-Ended Voltage Input**
 - **Antialiasing Filter Included**
 - **Digital HPF Included**
- **Stereo DAC:**
 - **Analog Performance at $V_{BUS} = 5$ V:**
 - THD+N = 0.005%
 - SNR = 96 dB
 - Dynamic Range = 93 dB
 - **Oversampling Digital Filter:**
 - Passband Ripple = ± 0.1 dB
 - Stop-Band Attenuation = -43 dB
 - **Single-Ended Voltage Output**
 - **Analog LPF Included**
- **Multifunctions:**
 - **Human Interface Device (HID) Function:**
 - Volume and Mute Controls
 - Suspend Flag Function
- **28-Pin SSOP Package**

APPLICATIONS

- **USB Audio Speaker**
- **USB Headset**
- **USB Monitor**
- **USB Audio Interface Box**

DESCRIPTION

The PCM2906C is Texas Instruments' single-chip, USB, stereo audio codec with a USB-compliant full-speed protocol controller and S/PDIF. The USB protocol controller requires no software code. The PCM2906C employs SpAct™ architecture, TI's unique system that recovers the audio clock from USB packet data. On-chip analog PLLs with SpAct enable playback and record with low clock jitter, as well as independent playback and record sampling rates.



Please be aware that an important notice concerning availability, standard warranty, and use in critical applications of Texas Instruments semiconductor products and disclaimers thereto appears at the end of this data sheet.

SpAct is a trademark of Texas Instruments.

System Two, Audio Precision are trademarks of Audio Precision, Inc.

All other trademarks are the property of their respective owners.



This integrated circuit can be damaged by ESD. Texas Instruments recommends that all integrated circuits be handled with appropriate precautions. Failure to observe proper handling and installation procedures can cause damage.

ESD damage can range from subtle performance degradation to complete device failure. Precision integrated circuits may be more susceptible to damage because very small parametric changes could cause the device not to meet its published specifications.

PACKAGING/ORDERING INFORMATION⁽¹⁾

PRODUCT	PACKAGE-LEAD	PACKAGE DESIGNATOR	SPECIFIED TEMPERATURE RANGE	PACKAGE MARKING	ORDERING NUMBER	TRANSPORT MEDIA, QUANTITY
PCM2906CDB	SSOP-28	DB	–25°C to +85°C	PCM2906C	PCM2906CDB	Rails, 47
					PCM2906CDBR	Tape and Reel, 2000

(1) For the most current package and ordering information, see the Package Option Addendum at the end of this document, or see the TI website at www.ti.com.

ABSOLUTE MAXIMUM RATINGS⁽¹⁾

Over operating free-air temperature range (unless otherwise noted).

PARAMETER		PCM2906C	UNIT
Supply voltage, V_{BUS}		–0.3 to 6.5	V
Ground voltage differences, AGNDC, AGNDP, AGNDX, DGND, DGNDU		±0.1	V
Digital input voltage	SEL0, SEL1, DIN	–0.3 to 6.5	V
	D+, D–, HID0, HID1, HID2, XTI, XTO, DOUT, \overline{SSPND}	–0.3 to $(V_{DDI} + 0.3) < 4$	
Analog input voltage	V_{INL} , V_{INR} , V_{COM} , V_{OUTR} , V_{OUTL}	–0.3 to $(V_{CCCI} + 0.3) < 4$	V
	V_{CCCI} , V_{CCP1I} , V_{CCP2I} , V_{CCXI} , V_{DDI}	–0.3 to 4	
Input current (any pins except supplies)		±10	mA
Ambient temperature under bias		–40 to +125	°C
Storage temperature, T_{stg}		–55 to +150	°C
Junction temperature, T_J		+150	°C
Lead temperature (soldering, 5s)		+260	°C
Package temperature (IR reflow, peak)		+250	°C

(1) Stresses beyond those listed under *Absolute Maximum Ratings* may cause permanent damage to the device. These are stress ratings only, and functional operation of the device at these or any other conditions beyond those indicated under is not implied. Exposure to absolute-maximum-rated conditions for extended periods may affect device reliability.

THERMAL INFORMATION

THERMAL METRIC ⁽¹⁾		PCM2906C	UNITS
		DB (SSOP)	
		28 PINS	
θ_{JA}	Junction-to-ambient thermal resistance	64.5	°C/W
θ_{JCTop}	Junction-to-case (top) thermal resistance	24.5	
θ_{JB}	Junction-to-board thermal resistance	25.4	
ψ_{JT}	Junction-to-top characterization parameter	2.0	
ψ_{JB}	Junction-to-board characterization parameter	25.0	
θ_{JCbott}	Junction-to-case (bottom) thermal resistance	N/A	

(1) For more information about traditional and new thermal metrics, see the *IC Package Thermal Metrics* application report, [SPRA953](http://www.ti.com/lit/spr953).

ELECTRICAL CHARACTERISTICS

All specifications at $T_A = +25^\circ\text{C}$, $V_{\text{BUS}} = 5\text{ V}$, $f_S = 44.1\text{ kHz}$, $f_{\text{IN}} = 1\text{ kHz}$, and 16-bit data (unless otherwise noted).

PARAMETER	TEST CONDITIONS	PCM2906C			UNIT	
		MIN	TYP	MAX		
DIGITAL INPUT/OUTPUT						
Host interface	Apply USB Revision 2.0, full speed					
Audio data format	USB isochronous data format					
INPUT LOGIC						
$V_{\text{IH}}^{(1)}$	Input logic level		2		VDC	
$V_{\text{IL}}^{(1)}$				3.3		
$V_{\text{IH}}^{(2)(3)}$			2.52			3.3
$V_{\text{IL}}^{(2)(3)}$						0.9
$V_{\text{IH}}^{(4)}$			2			5.25
$V_{\text{IL}}^{(4)}$						0.8
$V_{\text{IH}}^{(5)}$			2.52			5.25
$V_{\text{IL}}^{(5)}$						0.9
$I_{\text{IH}}^{(1)(2)(4)}$	Input logic current	$V_{\text{IN}} = 3.3\text{ V}$			μA	
$I_{\text{IL}}^{(1)(2)(4)}$		$V_{\text{IN}} = 0\text{ V}$				± 10
$I_{\text{IH}}^{(3)}$		$V_{\text{IN}} = 3.3\text{ V}$		50		80
$I_{\text{IL}}^{(3)}$		$V_{\text{IN}} = 0\text{ V}$				± 10
$I_{\text{IH}}^{(5)}$		$V_{\text{IN}} = 3.3\text{ V}$		65		100
$I_{\text{IL}}^{(5)}$		$V_{\text{IN}} = 0\text{ V}$				± 10
OUTPUT LOGIC						
$V_{\text{OH}}^{(1)}$	Output logic level		2.8		VDC	
$V_{\text{OL}}^{(1)}$						0.3
$V_{\text{OH}}^{(6)}$		$I_{\text{OH}} = -4\text{ mA}$	2.8			
$V_{\text{OL}}^{(6)}$		$I_{\text{OL}} = 4\text{ mA}$				0.5
$V_{\text{OH}}^{(7)}$		$I_{\text{OH}} = -2\text{ mA}$	2.8			
$V_{\text{OL}}^{(7)}$		$I_{\text{OL}} = 2\text{ mA}$				0.5
CLOCK FREQUENCY						
Input clock frequency, XTI		11.994	12	12.006	MHz	

- (1) Pins 1, 2: D+, D-.
 (2) Pin 21: XTI.
 (3) Pins 5, 6, 7: HID0, HID1, HID2.
 (4) Pins 8, 9: SEL0, SEL1.
 (5) Pin 24: DIN.
 (6) Pin 25: DOUT.
 (7) Pin 28: SSPND.

ELECTRICAL CHARACTERISTICS (continued)

All specifications at $T_A = +25^\circ\text{C}$, $V_{\text{BUS}} = 5\text{ V}$, $f_S = 44.1\text{ kHz}$, $f_{\text{IN}} = 1\text{ kHz}$, and 16-bit data (unless otherwise noted).

PARAMETER	TEST CONDITIONS	PCM2906C			UNIT
		MIN	TYP	MAX	
ADC CHARACTERISTICS					
Resolution			8, 16		Bits
Audio data channel			1, 2		Channel
ADC Clock Frequency					
f_s Sampling frequency			8, 11.025, 16, 22.05, 32, 44.1, 48		kHz
ADC DC Accuracy					
Gain mismatch, channel-to-channel			± 1	± 5	% of FSR
Gain error			± 2	± 10	% of FSR
Bipolar zero error			± 0		% of FSR
ADC Dynamic Performance⁽⁸⁾					
THD+N Total harmonic distortion plus noise	$V_{\text{IN}} = -1\text{ dB}^{(9)}$, $V_{\text{CCCI}} = 3.67\text{ V}$		0.01	0.02	%
	$V_{\text{IN}} = -1\text{ dB}^{(10)}$		0.1		%
	$V_{\text{IN}} = -60\text{ dB}$		5		%
Dynamic range	A-weighted	81	89		dB
SNR Signal-to-noise ratio	A-weighted	81	89		dB
Channel separation		80	85		dB
Analog Input					
Input voltage			$0.6 V_{\text{CCCI}}$		V_{PP}
Center voltage			$0.5 V_{\text{CCCI}}$		V
Input impedance			30		k Ω
Antialiasing filter frequency response	-3 dB		150		kHz
	$f_{\text{IN}} = 20\text{ kHz}$		-0.08		dB
ADC Digital Filter Performance					
Passband				$0.454 f_s$	Hz
Stop band		$0.583 f_s$			Hz
Passband ripple				± 0.05	dB
Stop-band attenuation		-65			dB
t_d Delay time				$17.4/f_s$	s
HPF frequency response	-3 dB			$0.078f_s/1000$	Hz

(8) $f_{\text{IN}} = 1\text{ kHz}$, using the System Two™ audio measurement system by Audio Precision™ in RMS mode with 20-kHz LPF, 400-Hz HPF in calculation.

(9) Using external voltage regulator for V_{CCCI} (see Figure 36).

(10) Using internal voltage regulator for V_{CCCI} (see Figure 37).

ELECTRICAL CHARACTERISTICS (continued)

 All specifications at $T_A = +25^\circ\text{C}$, $V_{\text{BUS}} = 5\text{ V}$, $f_S = 44.1\text{ kHz}$, $f_{\text{IN}} = 1\text{ kHz}$, and 16-bit data (unless otherwise noted).

PARAMETER	TEST CONDITIONS	PCM2906C			UNIT
		MIN	TYP	MAX	
DAC CHARACTERISTICS					
Resolution		8, 16			Bits
Audio data channel		1, 2			Channel
DAC Clock Frequency					
f_s Sampling frequency		32, 44.1, 48			kHz
DAC DC Accuracy					
Gain mismatch, channel-to-channel			± 1	± 5	% of FSR
Gain error			± 2	± 10	% of FSR
Bipolar zero error			± 2		% of FSR
DAC Dynamic Performance⁽¹¹⁾					
THD+N Total harmonic distortion plus noise	$V_{\text{OUT}} = 0\text{ dB}$		0.005	0.016	%
	$V_{\text{OUT}} = -60\text{ dB}$		3		%
Dynamic range	EIAJ, A-weighted	87	93		dB
SNR Signal-to-noise ratio	EIAJ, A-weighted	90	96		dB
Channel separation		86	92		dB
Analog Output					
V_O Output voltage		0.6 V_{CCCI}			V_{PP}
Center voltage		0.5 V_{CCCI}			V
Load impedance	AC coupling	10			k Ω
LPF frequency response	-3 dB		250		kHz
	$f = 20\text{ kHz}$		-0.03		dB
DAC Digital Filter Performance					
Passband				$0.445 f_s$	Hz
Stop band		$0.555 f_s$			Hz
Passband ripple				± 0.1	dB
Stop-band attenuation		-43			dB
t_d Delay time			$14.3 f_s$		s
POWER-SUPPLY REQUIREMENTS					
V_{BUS} Voltage range		4.35	5	5.25	VDC
Supply current	ADC, DAC operation		56	67	mA
	Suspend mode ⁽¹²⁾		250		μA
P_D Power dissipation	ADC, DAC operation		280	352	mW
	Suspend mode ⁽¹²⁾		1.25		mW
Internal power-supply voltage ⁽¹³⁾		3.1	3.3	3.5	VDC
TEMPERATURE RANGE					
Operating temperature range		-25		+85	$^\circ\text{C}$

 (11) $f_{\text{OUT}} = 1\text{ kHz}$, using the System Two audio measurement system by Audio Precision in RMS mode with 20-kHz LPF, 400-Hz HPF.

(12) In USB suspend state.

 (13) Pins 10, 17, 19, 23, 27: V_{CCCI} , V_{CCP1} , V_{CCP2} , V_{CCX1} , V_{DDI} .

PIN ASSIGNMENTS

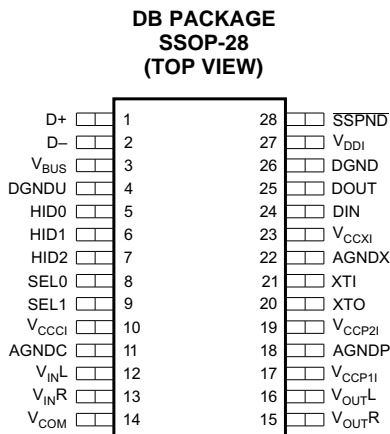

P0007-05

Table 1. TERMINAL FUNCTIONS

NAME	NO.	I/O	DESCRIPTION
AGNDC	11	—	Analog ground for codec
AGNDP	18	—	Analog ground for PLL
AGNDX	22	—	Analog ground for oscillator
D-	2	I/O	USB differential input/output minus ⁽¹⁾
D+	1	I/O	USB differential input/output plus ⁽¹⁾
DGND	26	—	Digital ground
DGNDU	4	—	Digital ground for USB transceiver
DIN	24	I	S/PDIF input ⁽²⁾
DOUT	25	O	S/PDIF output
HID0	5	I	HID key state input (mute), active-high ⁽³⁾
HID1	6	I	HID key state input (volume up), active-high ⁽³⁾
HID2	7	I	HID key state input (volume down), active-high ⁽³⁾
SEL0	8	I	Must be set to high ⁽⁴⁾
SEL1	9	I	Must be set to high ⁽⁴⁾
SSPND	28	O	Suspend flag, active-low (Low: suspend, High: operational)
V _{BUS}	3	—	Connect to USB power (V _{BUS})
V _{CCCI}	10	—	Internal analog power supply for codec ⁽⁵⁾
V _{CCP1I}	17	—	Internal analog power supply for PLL ⁽⁵⁾
V _{CCP2I}	19	—	Internal analog power supply for PLL ⁽⁵⁾
V _{CCXI}	23	—	Internal analog power supply for oscillator ⁽⁵⁾
V _{COM}	14	—	Common for ADC/DAC (V _{CCCI/2}) ⁽⁵⁾
V _{DDI}	27	—	Internal digital power supply ⁽⁵⁾
V _{INL}	12	I	ADC analog input for L-channel
V _{INR}	13	I	ADC analog input for R-channel
V _{OUTL}	16	O	DAC analog output for L-channel
V _{OUTR}	15	O	DAC analog output for R-channel
XTI	21	I	Crystal oscillator input ⁽⁶⁾
XTO	20	O	Crystal oscillator output

(1) LV-TTL level.

(2) 3.3-V CMOS-level input with internal pulldown, 5-V tolerant.

(3) 3.3-V CMOS-level input with internal pulldown. This pin informs the PC of serviceable control signals such as mute, volume up, or volume down, which have no direct connection with the internal DAC or ADC. See the [Interface #3](#) and [End-Points](#) sections.

(4) TTL Schmitt trigger, 5-V tolerant.

(5) Connect a decoupling capacitor to GND.

(6) 3.3-V CMOS-level input.

FUNCTIONAL BLOCK DIAGRAM

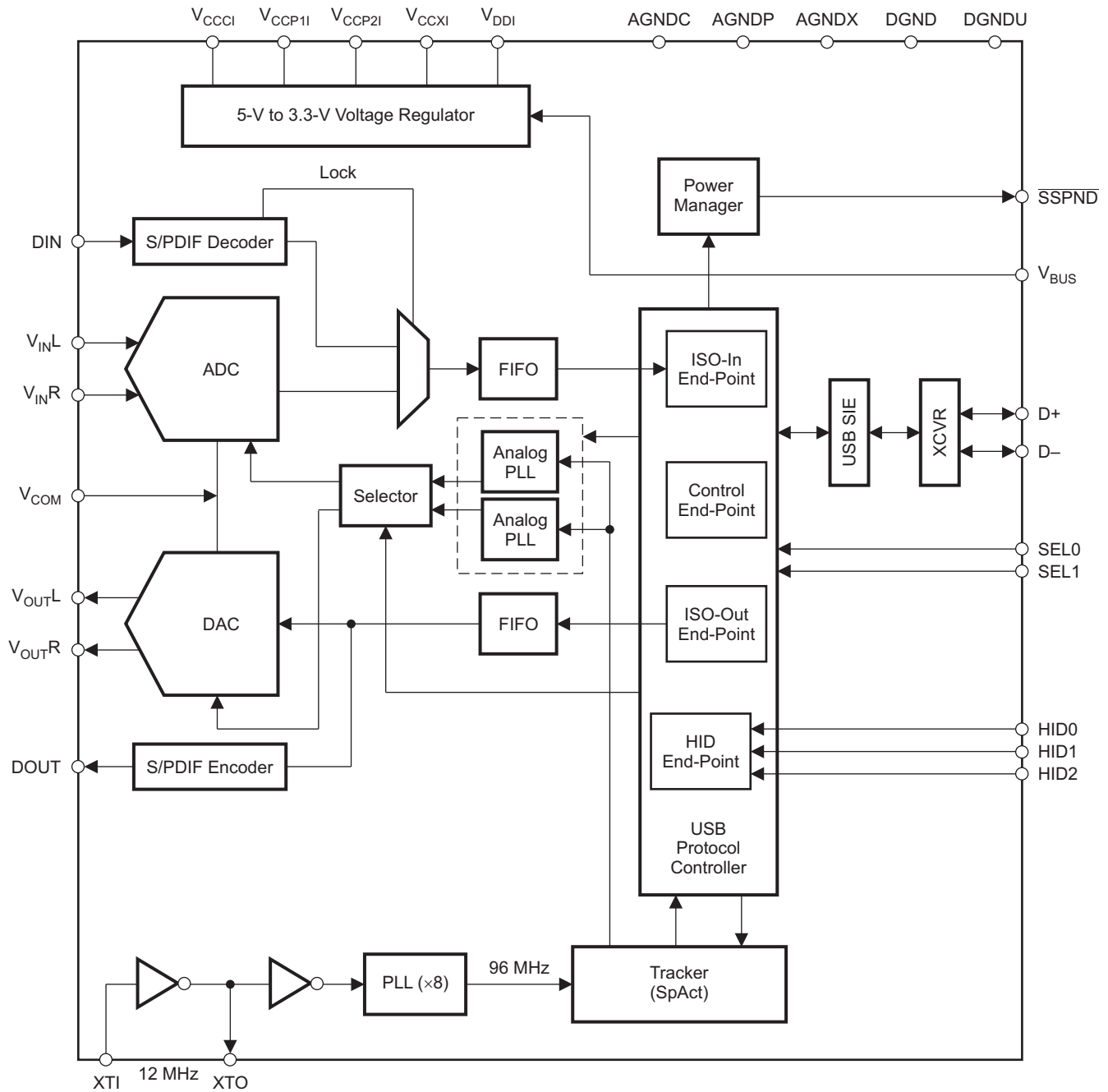

B0239-01

BLOCK DIAGRAM OF ANALOG FRONT-END (RIGHT CHANNEL)

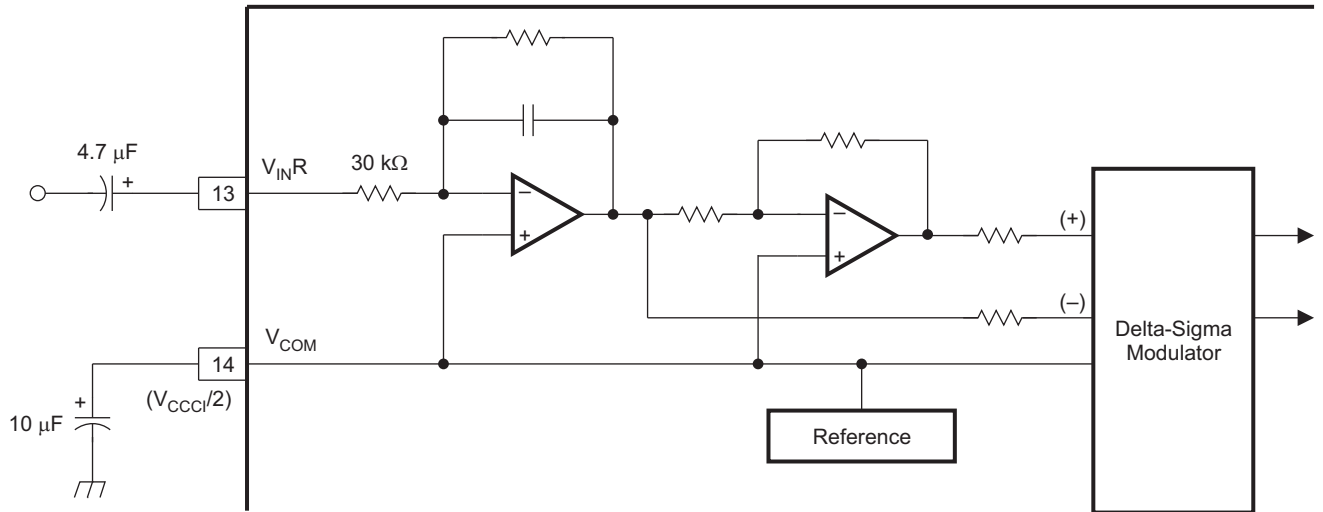

S0011-06

TYPICAL CHARACTERISTICS: ADC

All specifications at $T_A = +25^\circ\text{C}$, $V_{\text{BUS}} = 5\text{ V}$, $f_s = 44.1\text{ kHz}$, $f_{\text{IN}} = 1\text{ kHz}$, 16-bit data, using REG103xA-A, unless otherwise noted.

**TOTAL HARMONIC DISTORTION + NOISE AT -1 dB
vs
FREE-AIR TEMPERATURE**

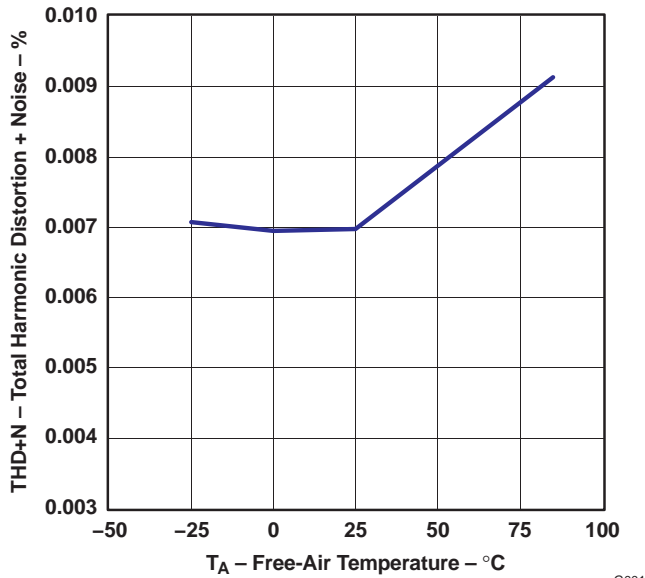

Figure 1.

**DYNAMIC RANGE and SNR
vs
FREE-AIR TEMPERATURE**

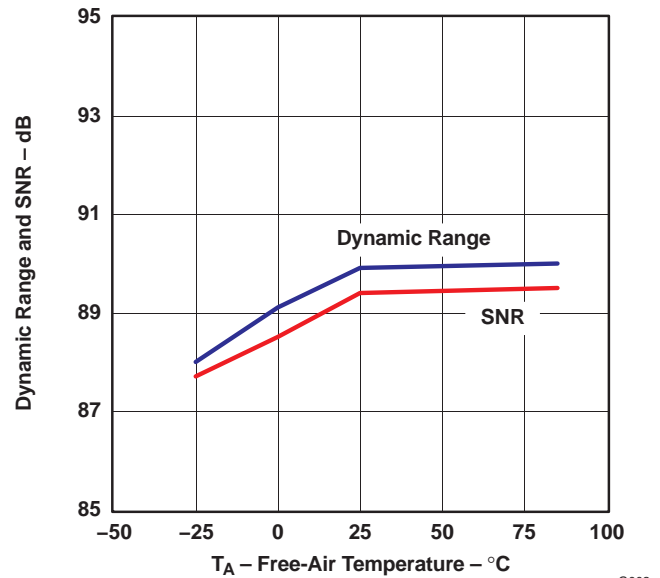

Figure 2.

**TOTAL HARMONIC DISTORTION + NOISE AT -1 dB
vs
SUPPLY VOLTAGE**

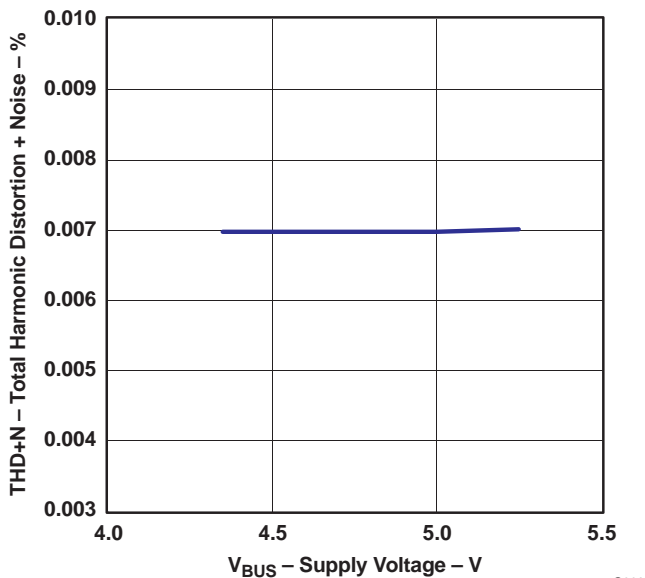

Figure 3.

**DYNAMIC RANGE and SNR
vs
SUPPLY VOLTAGE**

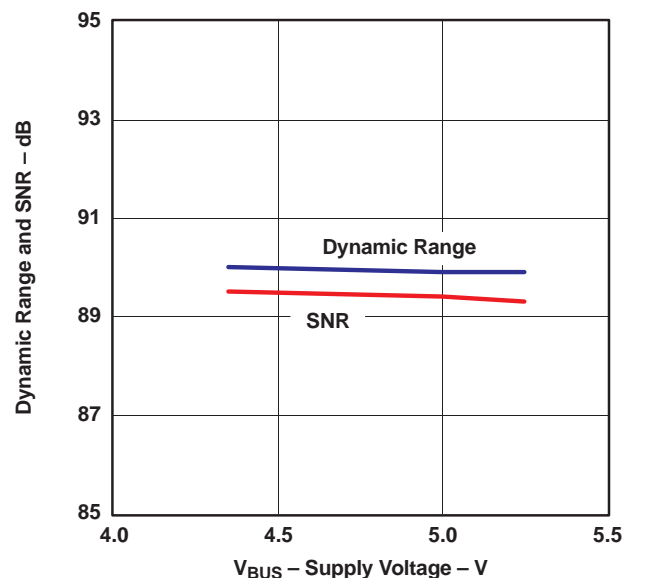

Figure 4.

TYPICAL CHARACTERISTICS: ADC (continued)

All specifications at $T_A = +25^\circ\text{C}$, $V_{\text{BUS}} = 5\text{ V}$, $f_s = 44.1\text{ kHz}$, $f_{\text{IN}} = 1\text{ kHz}$, 16-bit data, using REG103xA-A, unless otherwise noted.

TOTAL HARMONIC DISTORTION + NOISE AT -1 dB
vs
SAMPLING FREQUENCY

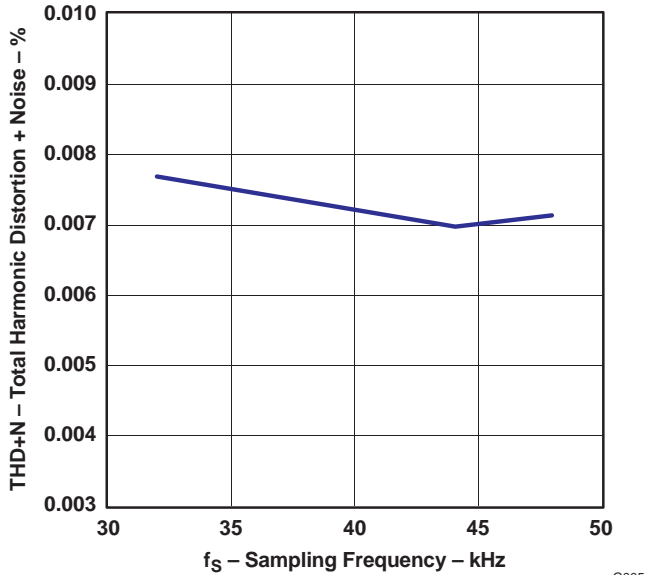

Figure 5.

DYNAMIC RANGE and SNR
vs
SAMPLING FREQUENCY

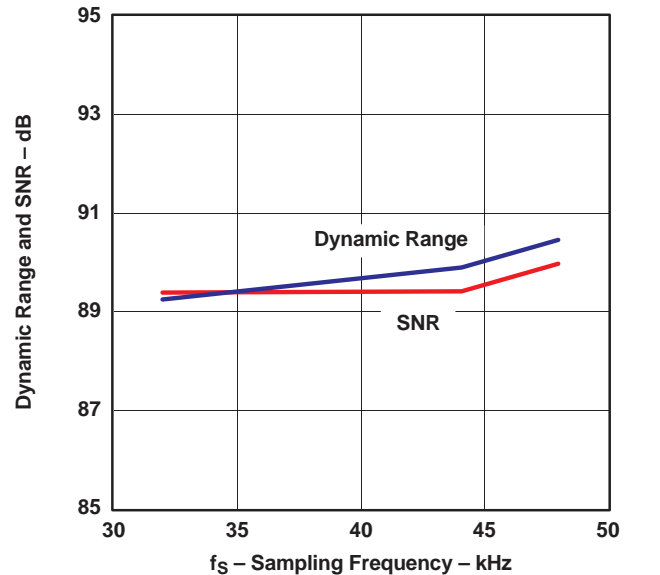

Figure 6.

TYPICAL CHARACTERISTICS: DAC

All specifications at $T_A = +25^\circ\text{C}$, $V_{\text{BUS}} = 5\text{ V}$, $f_s = 44.1\text{ kHz}$, $f_{\text{IN}} = 1\text{ kHz}$, 16-bit data, using REG103xA-A, unless otherwise noted.

TOTAL HARMONIC DISTORTION + NOISE AT 0 dB
vs
FREE-AIR TEMPERATURE

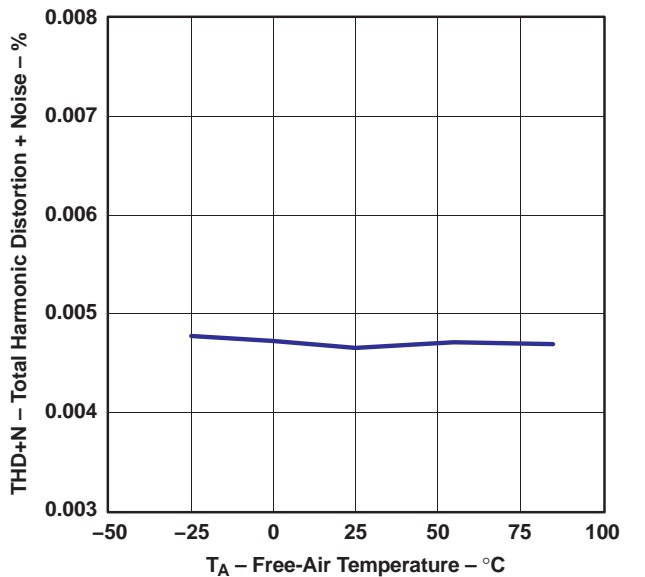

Figure 7.

DYNAMIC RANGE and SNR
vs
FREE-AIR TEMPERATURE

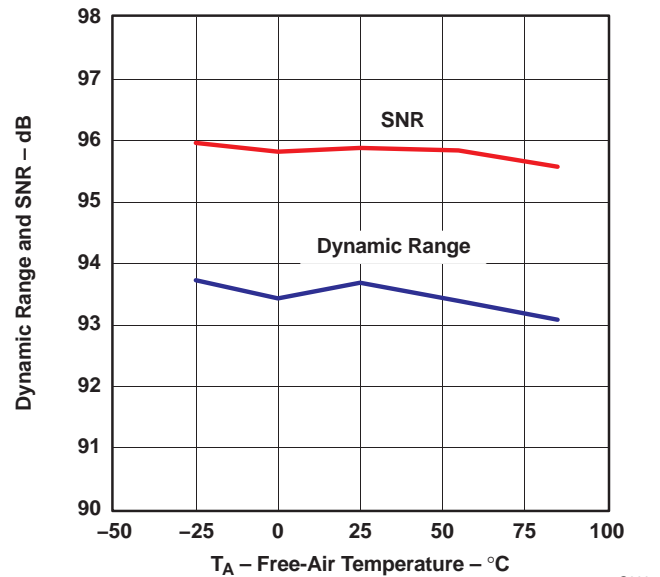

Figure 8.

TYPICAL CHARACTERISTICS: DAC (continued)

All specifications at $T_A = +25^\circ\text{C}$, $V_{\text{BUS}} = 5\text{ V}$, $f_s = 44.1\text{ kHz}$, $f_{\text{IN}} = 1\text{ kHz}$, 16-bit data, using REG103xA-A, unless otherwise noted.

**TOTAL HARMONIC DISTORTION + NOISE AT 0 dB
vs
SUPPLY VOLTAGE**

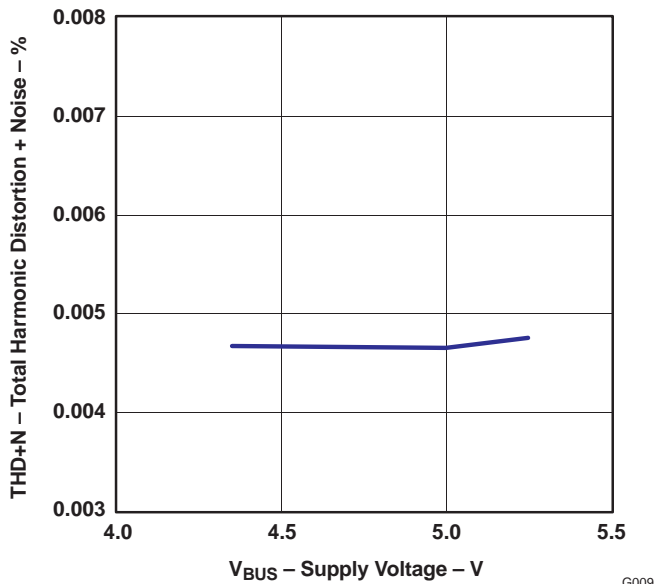

Figure 9.

**DYNAMIC RANGE and SNR
vs
SUPPLY VOLTAGE**

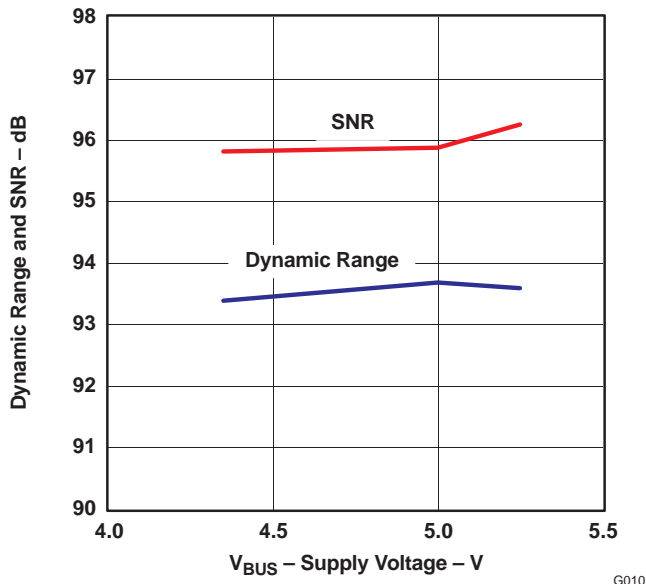

Figure 10.

**TOTAL HARMONIC DISTORTION + NOISE AT 0 dB
vs
SAMPLING FREQUENCY**

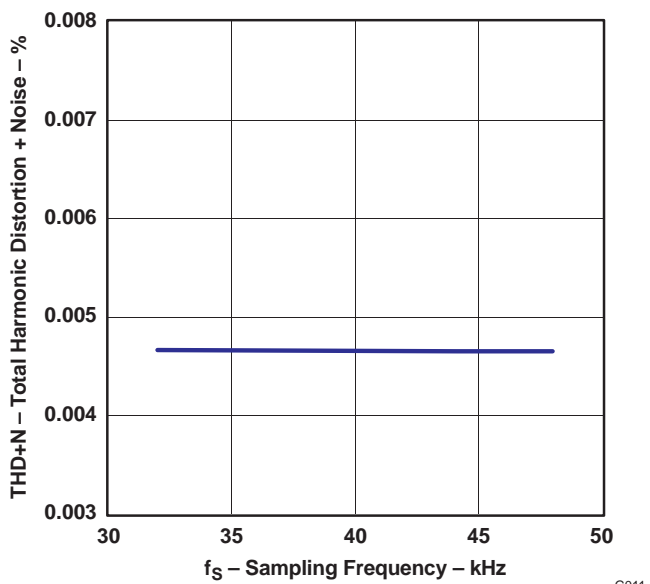

Figure 11.

**DYNAMIC RANGE and SNR
vs
SAMPLING FREQUENCY**

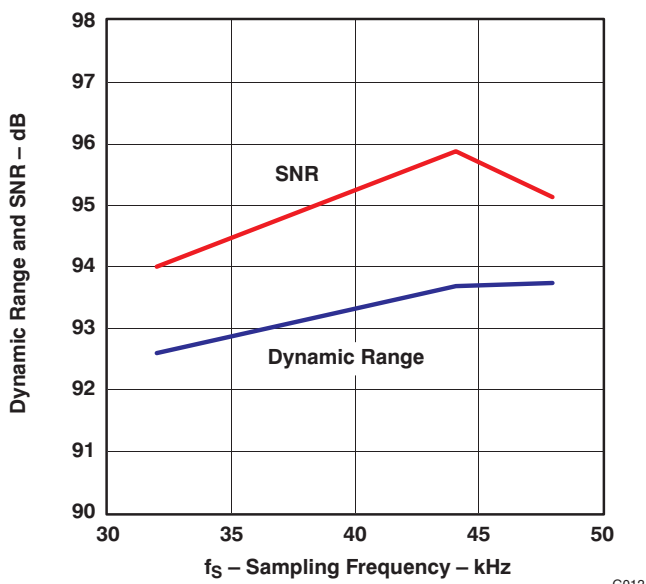

Figure 12.

TYPICAL CHARACTERISTICS: SUPPLY CURRENT

All specifications at $T_A = +25^\circ\text{C}$, $V_{BUS} = 5\text{ V}$, $f_s = 44.1\text{ kHz}$, $f_{IN} = 1\text{ kHz}$, 16-bit data, using REG103xA-A, unless otherwise noted.

OPERATIONAL and SUSPEND SUPPLY CURRENT
vs
SUPPLY VOLTAGE

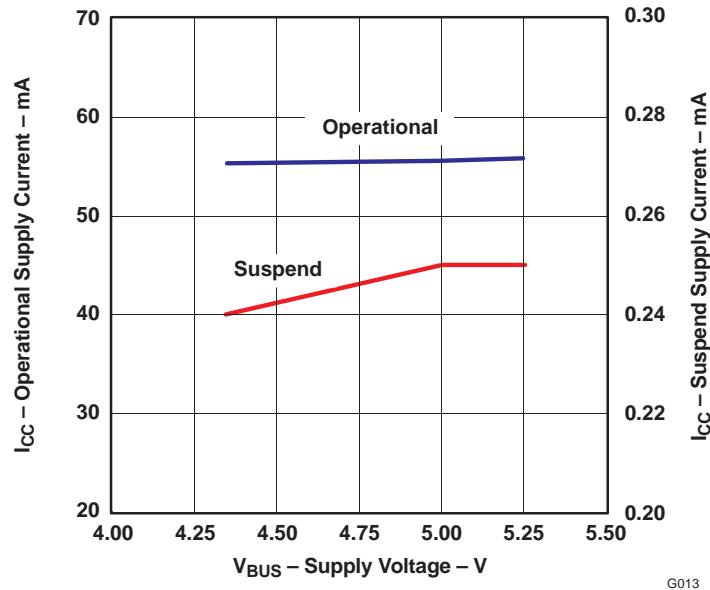

Figure 13.

OPERATIONAL SUPPLY CURRENT
vs
SAMPLING FREQUENCY

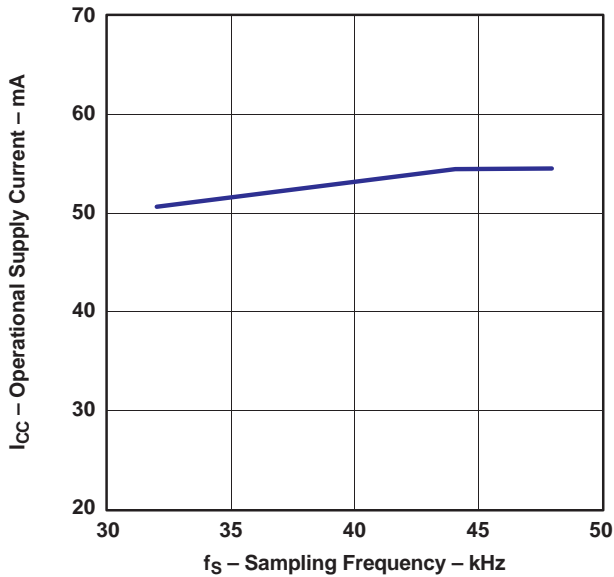

Figure 14.

SUSPEND SUPPLY CURRENT
vs
FREE-AIR TEMPERATURE

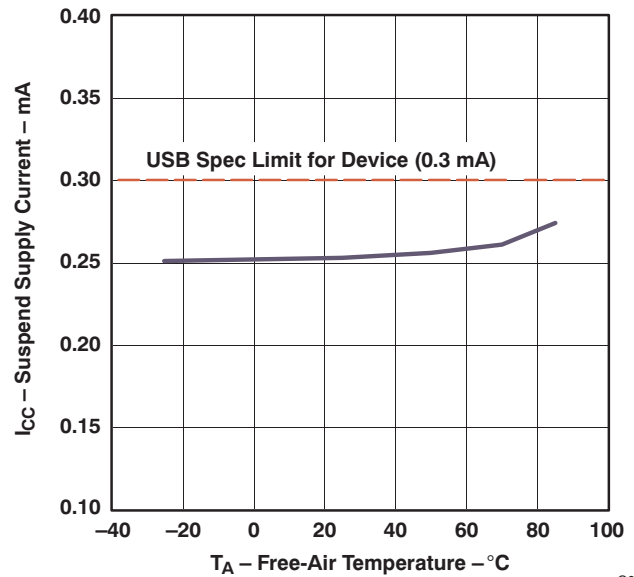

Figure 15.

TYPICAL CHARACTERISTICS: ADC DIGITAL DECIMATION FILTER FREQUENCY RESPONSE

All specifications at $T_A = +25^\circ\text{C}$, $V_{BUS} = 5\text{ V}$, $f_s = 44.1\text{ kHz}$, $f_{IN} = 1\text{ kHz}$, 16-bit data, unless otherwise noted.

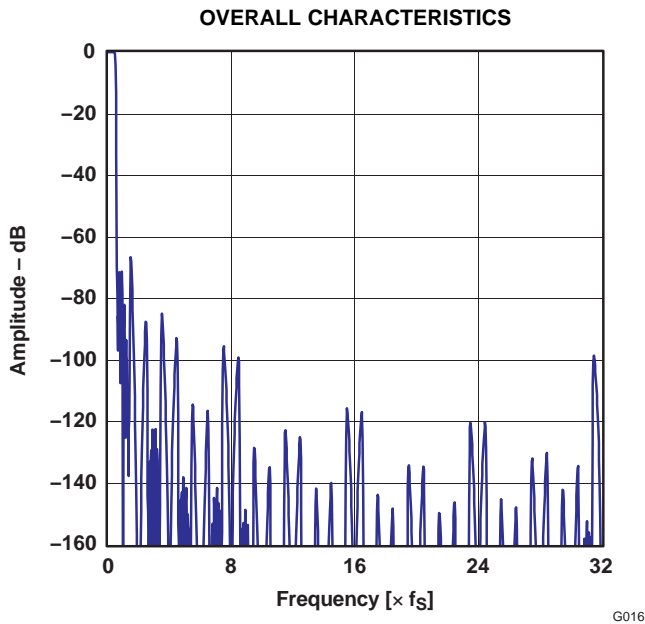

Figure 16.

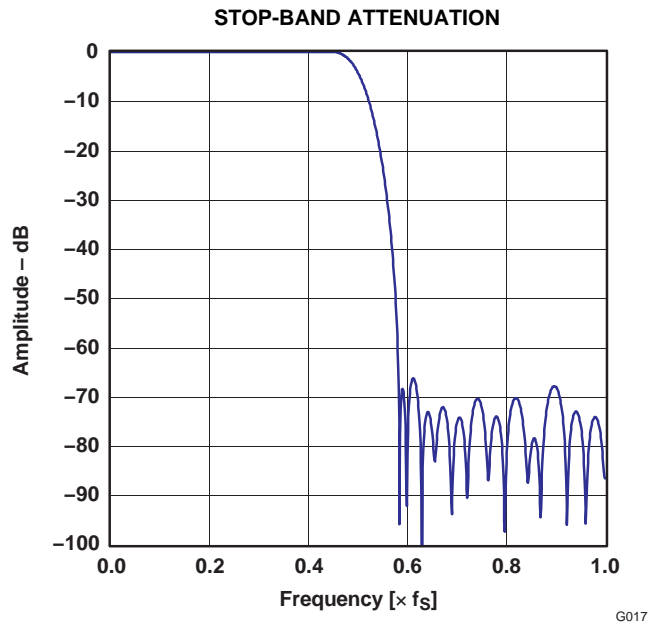

Figure 17.

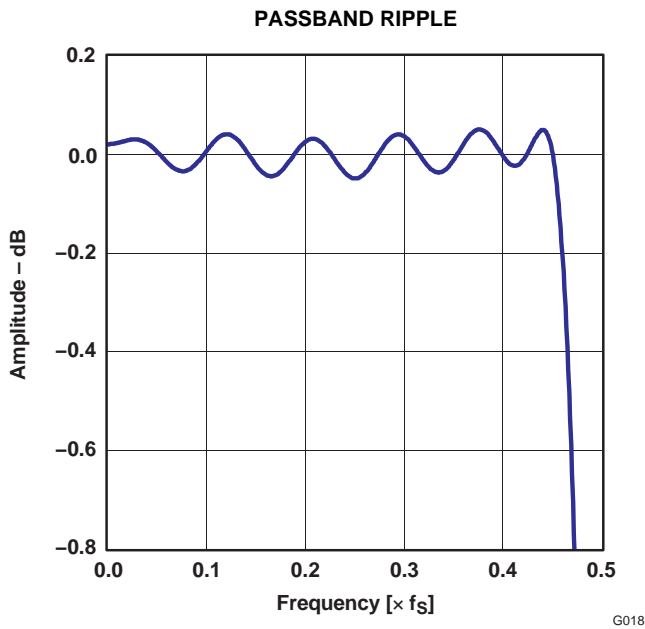

Figure 18.

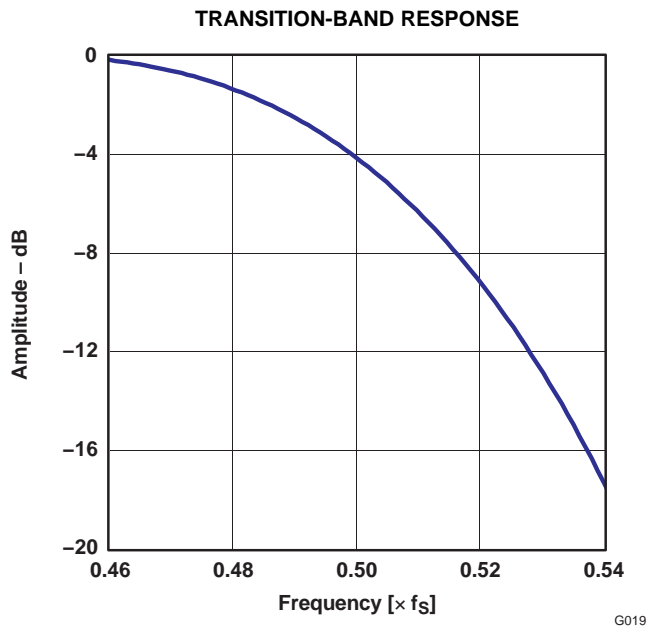

Figure 19.

TYPICAL CHARACTERISTICS: ADC DIGITAL HIGH-PASS FILTER FREQUENCY RESPONSE

All specifications at $T_A = +25^\circ\text{C}$, $V_{BUS} = 5\text{ V}$, $f_s = 44.1\text{ kHz}$, $f_{IN} = 1\text{ kHz}$, 16-bit data, unless otherwise noted.

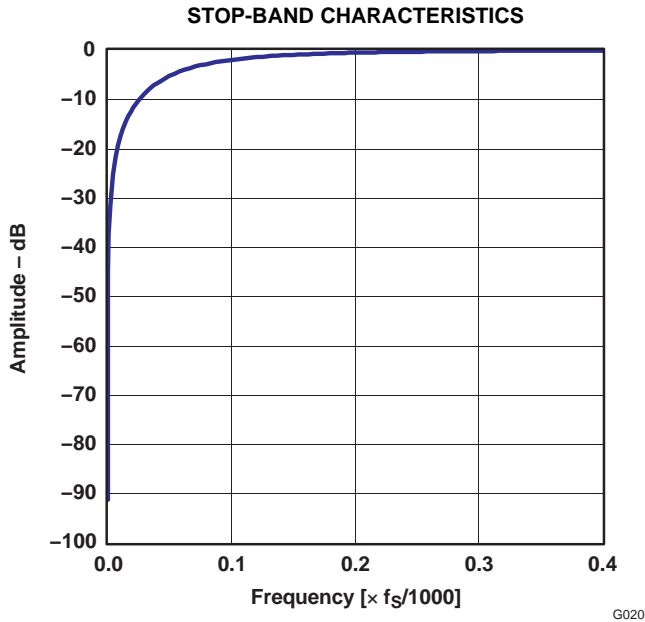

Figure 20.

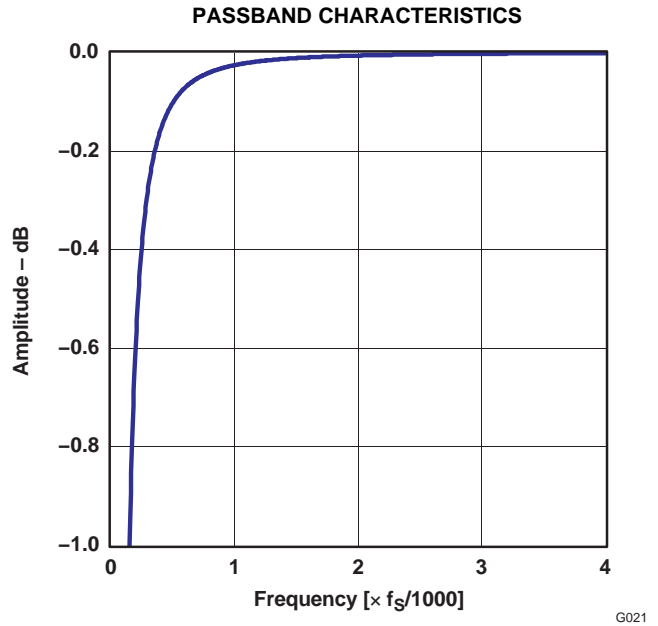

Figure 21.

TYPICAL CHARACTERISTICS: ADC ANALOG ANTIALIASING FILTER FREQUENCY RESPONSE

All specifications at $T_A = +25^\circ\text{C}$, $V_{BUS} = 5\text{ V}$, $f_s = 44.1\text{ kHz}$, $f_{IN} = 1\text{ kHz}$, 16-bit data, unless otherwise noted.

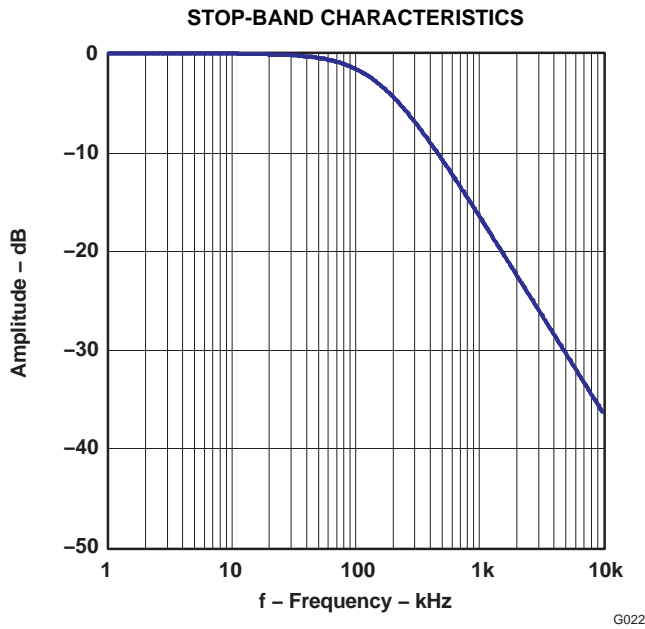

Figure 22.

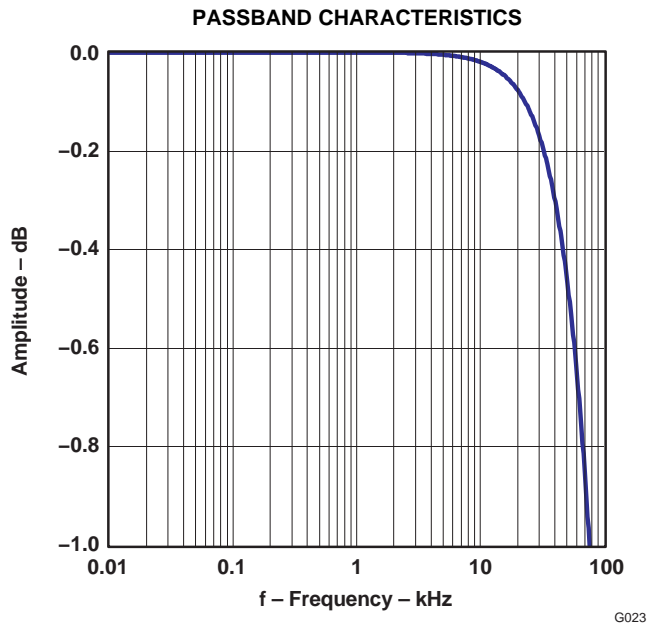

Figure 23.

TYPICAL CHARACTERISTICS: DAC DIGITAL INTERPOLATION FILTER FREQUENCY RESPONSE

All specifications at $T_A = +25^\circ\text{C}$, $V_{BUS} = 5\text{ V}$, $f_s = 44.1\text{ kHz}$, $f_{IN} = 1\text{ kHz}$, 16-bit data, unless otherwise noted.

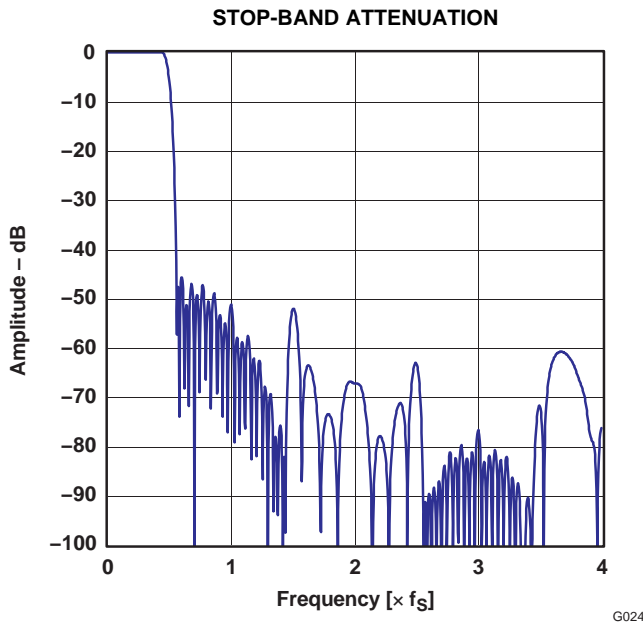

Figure 24.

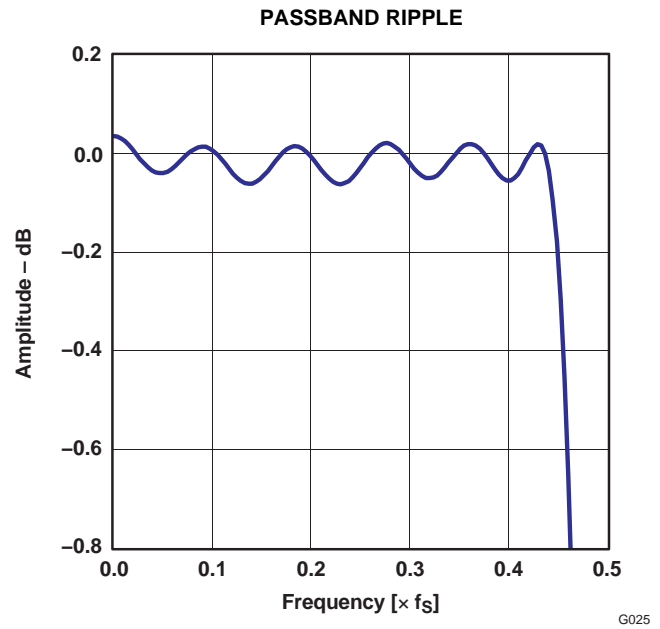

Figure 25.

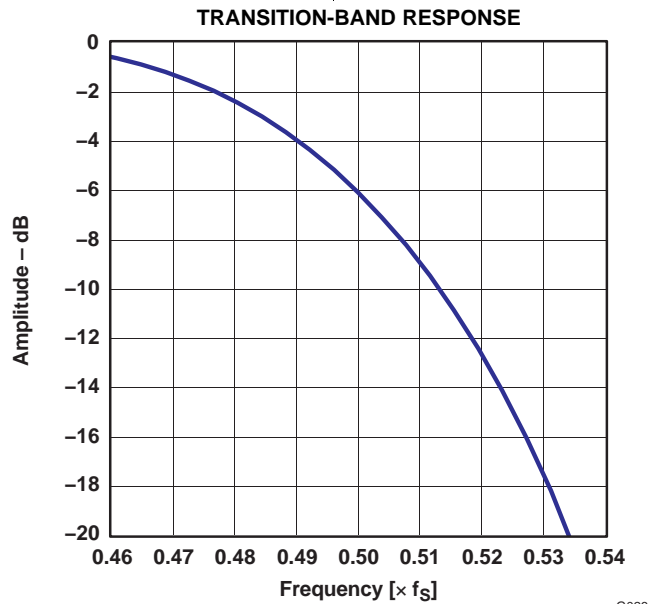

Figure 26.

TYPICAL CHARACTERISTICS: DAC ANALOG FIR FILTER FREQUENCY RESPONSE

All specifications at $T_A = +25^\circ\text{C}$, $V_{BUS} = 5\text{ V}$, $f_s = 44.1\text{ kHz}$, $f_{IN} = 1\text{ kHz}$, 16-bit data, unless otherwise noted.

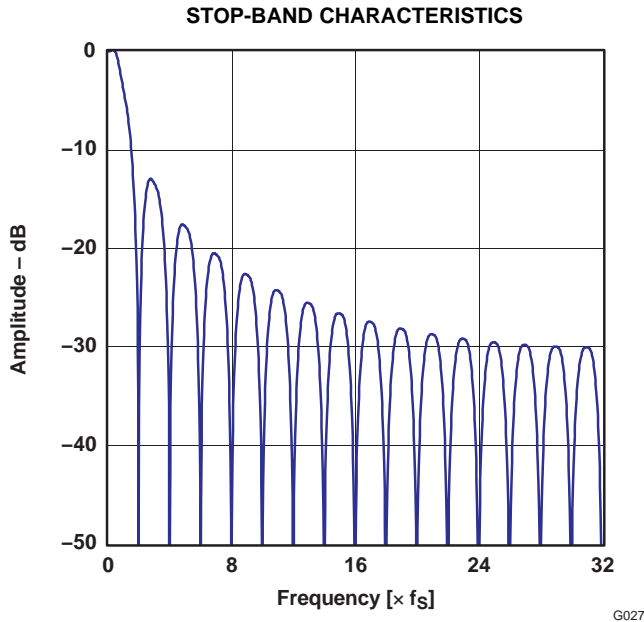

Figure 27.

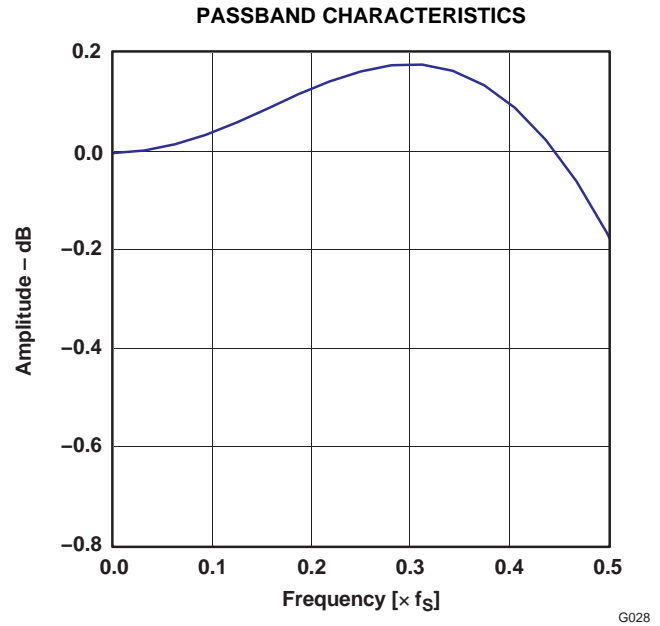

Figure 28.

TYPICAL CHARACTERISTICS: DAC ANALOG LOW-PASS FILTER FREQUENCY RESPONSE

All specifications at $T_A = +25^\circ\text{C}$, $V_{BUS} = 5\text{ V}$, $f_s = 44.1\text{ kHz}$, $f_{IN} = 1\text{ kHz}$, 16-bit data, unless otherwise noted.

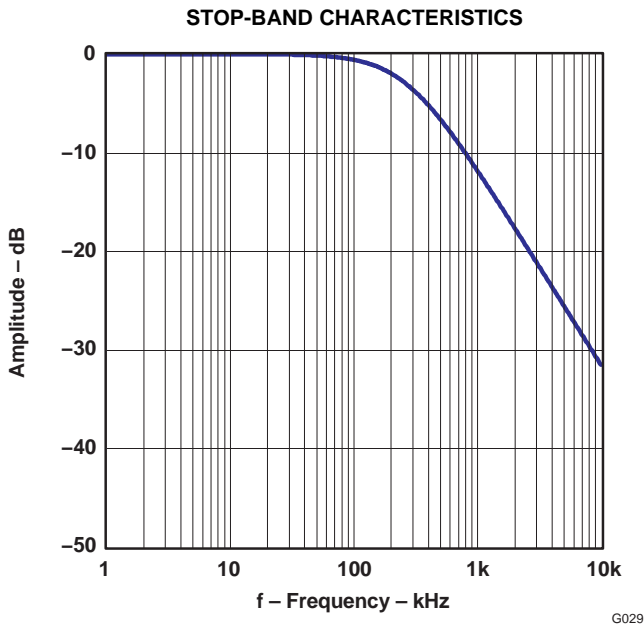

Figure 29.

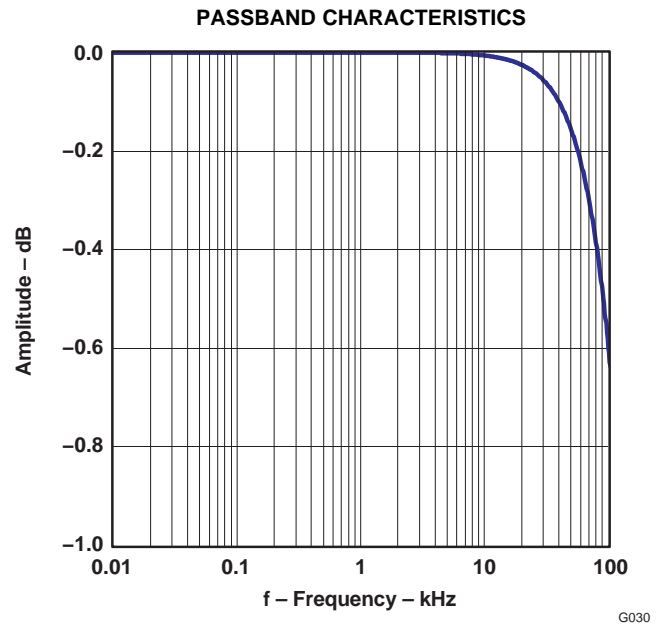

Figure 30.

DETAILED DESCRIPTION

USB INTERFACE

Control data and audio data are transferred to the PCM2906C via D+ (pin 1) and D– (pin 2). All data to/from the PCM2906C are transferred at full speed. The device descriptor contains the information described in [Table 2](#).

Table 2. Device Descriptor

USB revision	2.0 compliant
Device class	0x00 (device defined interface level)
Device sub class	0x00 (not specified)
Device protocol	0x00 (not specified)
Max packet size for end-point 0	8 byte
Vendor ID	0x08BB
Product ID	0x29C6
Device release number	1.0 (0x0100)
Number of configurations	1
Vendor string	String #1 (see Table 4)
Product string	String #2 (see Table 4)
Serial number	Not supported

The configuration descriptor contains the information described in [Table 3](#).

Table 3. Configuration Descriptor

Interface	Four interfaces
Power attribute	0x80 (Bus powered, no remote wakeup)
Max power	0xFA (500 mA)

The string descriptor contains the information described in [Table 4](#).

Table 4. String Descriptor

#0	0x0409
#1	BurrBrown from Texas Instruments
#2	USB AUDIO CODEC

DEVICE CONFIGURATION

Figure 31 illustrates the USB audio function topology. The PCM2906C has four interfaces. Each interface consists of alternative settings.

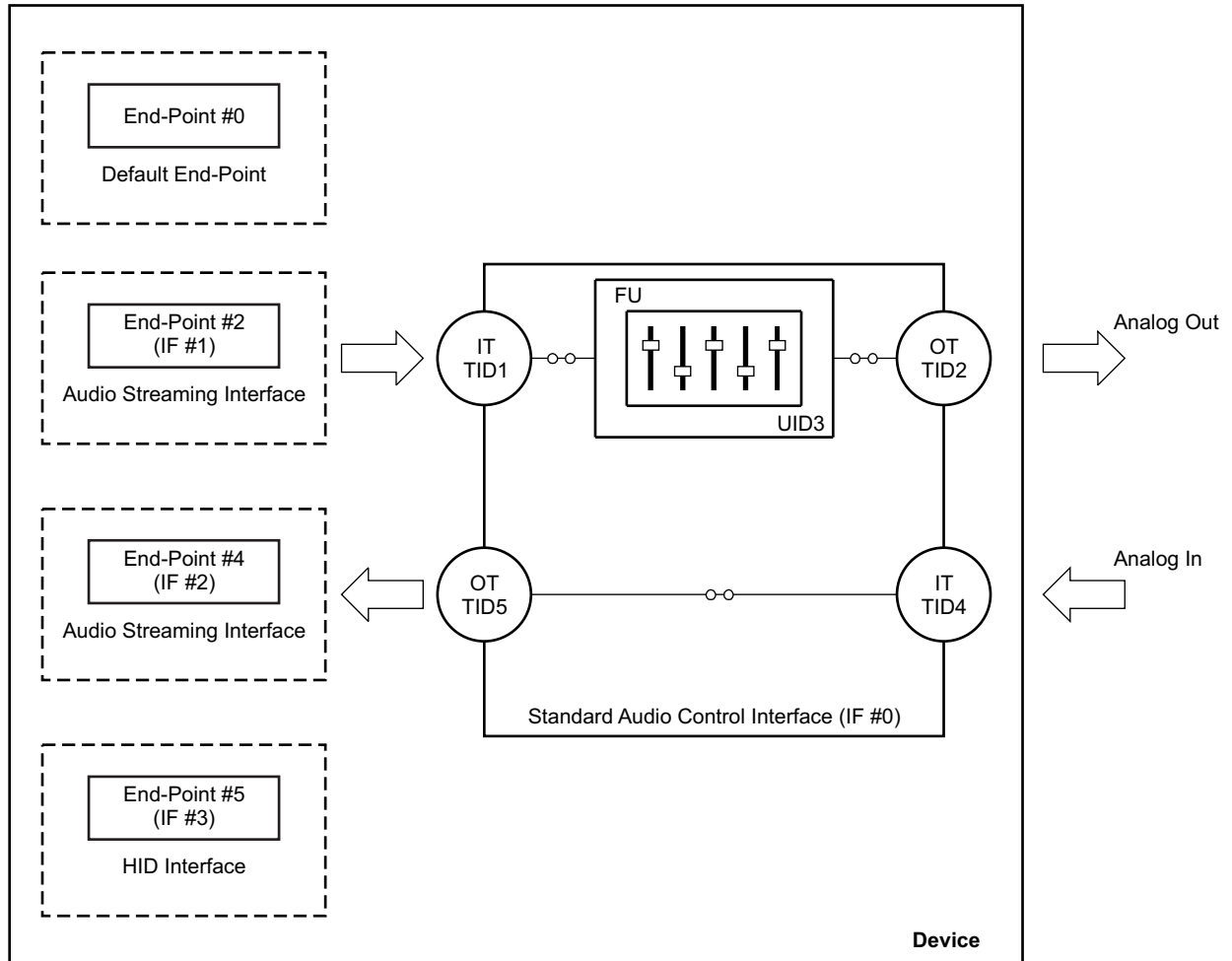

M0024-02

Figure 31. USB Audio Function Topology

Interface #0

Interface #0 is the control interface. Alternative setting #0 is the only possible setting for interface #0. Alternative setting #0 describes the standard audio control interface. The audio control interface consists of a single terminal. The PCM2906C has the following five terminals:

- Input terminal (IT #1) for isochronous-out stream
- Output terminal (OT #2) for audio analog output
- Feature unit (FU #3) for DAC digital attenuator
- Input terminal (IT #4) for audio analog input
- Output terminal (OT #5) for isochronous-in stream

Input terminal #1 is defined as a *USB stream* (terminal type 0x0101). Input terminal #1 can accept two-channel audio streams consisting of left and right channels. Output terminal #2 is defined as a *speaker* (terminal type 0x0301). Input terminal #4 is defined as a *line connector* (terminal type 0x0603). Output terminal #5 is defined as a *USB stream* (terminal type 0x0101). Output terminal #5 can generate two-channel audio streams composed of left and right channel data. Feature unit #3 supports the following sound control features:

- Volume control
- Mute control

The built-in digital volume controller can be manipulated by an audio-class-specific request from 0 dB to –64 dB in 1-dB steps. Changes are made by incrementing or decrementing by one step (1 dB) for every $1/f_s$ time interval until the volume level has reached the requested value. Each channel can be set for different values. The master volume control is not supported. A request to the master volume is stalled and ignored. The built-in digital mute controller can be manipulated by audio-class-specific request. A master mute control request is acceptable. A request to an individual channel is stalled and ignored.

Interface #1

Interface #1 is the audio streaming data-out interface. Interface #1 has the five alternative settings listed in [Table 5](#). Alternative setting #0 is the zero-bandwidth setting. All other alternative settings are operational settings.

Table 5. Interface #1 Alternative Settings

ALTERNATIVE SETTING	DATA FORMAT			TRANSFER MODE	SAMPLING RATE (kHz)
00	Zero bandwidth				
01	16-bit	Stereo	Twos complement (PCM)	Adaptive	32, 44.1, 48
02	16-bit	Mono	Twos complement (PCM)	Adaptive	32, 44.1, 48
03	8-bit	Stereo	Twos complement (PCM)	Adaptive	32, 44.1, 48
04	8-bit	Mono	Twos complement (PCM)	Adaptive	32, 44.1, 48

Interface #2

Interface #2 is the audio streaming data-in interface. Interface #2 has the 19 alternative settings listed in [Table 6](#). Alternative setting #0 is the zero-bandwidth setting. All other alternative settings are operational settings.

Table 6. Interface #2 Alternative Settings

ALTERNATIVE SETTING	DATA FORMAT			TRANSFER MODE	SAMPLING RATE (kHz)
00	Zero Bandwidth				
01	16-bit	Stereo	Twos complement (PCM)	Asynchronous	48
02	16-bit	Mono	Twos complement (PCM)	Asynchronous	48
03	16-bit	Stereo	Twos complement (PCM)	Asynchronous	44.1
04	16-bit	Mono	Twos complement (PCM)	Asynchronous	44.1
05	16-bit	Stereo	Twos complement (PCM)	Asynchronous	32
06	16-bit	Mono	Twos complement (PCM)	Asynchronous	32
07	16-bit	Stereo	Twos complement (PCM)	Asynchronous	22.05
08	16-bit	Mono	Twos complement (PCM)	Asynchronous	22.05
09	16-bit	Stereo	Twos complement (PCM)	Asynchronous	16
0A	16-bit	Mono	Twos complement (PCM)	Asynchronous	16
0B	8-bit	Stereo	Twos complement (PCM)	Asynchronous	16
0C	8-bit	Mono	Twos complement (PCM)	Asynchronous	16
0D	8-bit	Stereo	Twos complement (PCM)	Asynchronous	8
0E	8-bit	Mono	Twos complement (PCM)	Asynchronous	8
0F	16-bit	Stereo	Twos complement (PCM)	Synchronous	11.025
10	16-bit	Mono	Twos complement (PCM)	Synchronous	11.025
11	8-bit	Stereo	Twos complement (PCM)	Synchronous	11.025
12	8-bit	Mono	Twos complement (PCM)	Synchronous	11.025

Interface #3

Interface #3 is the interrupt data-in interface. Alternative setting #0 is the only possible setting for interface #3. Interface #3 consists of the HID consumer control device and reports the status of these three key parameters:

- Mute (0xE209)
- Volume up (0xE909)
- Volume down (0xEA09)

End-Points

The PCM2906C has the following four end-points:

- Control end-point (EP #0)
- Isochronous-out audio data stream end-point (EP #2)
- Isochronous-in audio data stream end-point (EP #4)
- HID end-point (EP #5)

The control end-point is a default end-point. The control end-point is used to control all functions of the PCM2906C by the standard USB request and USB audio class specific request from the host. The isochronous-out audio data stream end-point is an audio sink end-point, which receives the PCM audio data. The isochronous-out audio data stream end-point accepts the adaptive transfer mode. The isochronous-in audio data stream end-point is an audio source end-point that transmits the PCM audio data. The isochronous-in audio data stream end-point uses the asynchronous transfer mode. The HID end-point is an interrupt-in end-point. The HID end-point reports HID0, HID1, and HID2 pin status every 32 ms.

The human interface device (HID) pins are defined as consumer control devices. The HID function is designed as an independent end-point from both isochronous-in and -out end-points. Therefore, the result obtained from the HID operation depends on the host software. Typically, the HID function is used as the primary audio-out device.

Clock and Reset

The PCM2906C requires a 12-MHz (± 500 ppm) clock for the USB and audio functions. The clock can be generated by a built-in oscillator with a 12-MHz crystal resonator. The 12-MHz crystal resonator must be connected to XTI (pin 21) and XTO (pin 20) with one high-value (1-M Ω) resistor and two small capacitors, the capacitance of which depends on the load capacitance of the crystal resonator. An external clock can be supplied to XTI (pin 21). If an external clock is used, XTO (pin 20) must be left open. Because there is no clock disabling signal, use of the external clock supply is not recommended. SSPND (pin 28) is unable to use clock disabling.

The PCM2906C has an internal power-on reset circuit, which triggers automatically when V_{BUS} (pin 3) exceeds 2.5 V typical (2.7 V to 2.2 V). Approximately 700 μ s is required until internal reset release.

Digital Audio Interface

The PCM2906C employs S/PDIF for both input and output. Isochronous-out data from the host are encoded to the S/PDIF output and the DAC analog output. Input data are selected from either the S/PDIF or ADC analog input. When the device detects S/PDIF input and successfully locks the received data, the isochronous-in transfer data source automatically selected is S/PDIF; otherwise, the data source selected is the ADC analog input.

This feature is a customer option. It is the responsibility of the user to implement this feature.

Supported Input/Output Data

The following data formats are accepted by S/PDIF for input and output. All other data formats are unusable as S/PDIF.

- 48-kHz 16-bit stereo
- 44.1-kHz 16-bit stereo
- 32-kHz 16-bit stereo

Any mismatch of the sampling rate between the input S/PDIF signal and the host command is not acceptable. Any mismatch of the data format between the input S/PDIF signal and the host command may cause unexpected results, with the following exceptions:

- Recording in monaural format from stereo data input at the same data rate
- Recording in 8-bit format from 16-bit data input at the same data rate

A combination of these two conditions is not acceptable.

For playback, all possible data-rate sources are converted to the 16-bit stereo format at the same source data rate.

Channel Status Information

The channel status information is fixed as consumer application, PCM mode, copyright, and digital/digital converter. All other bits are fixed as 0's except for the sample frequency, which is set automatically according to the data received through the USB.

Copyright Management

Isochronous-in data are affected by the serial copy management system (SCMS). When the control bit indicates that the received digital audio data are original, the input digital audio data are transferred to the host. If the data are indicated as first generation or higher, the transferred data are routed to the analog input.

Digital audio data output is always encoded as original with SCMS control.

INTERFACE SEQUENCE

Power-On, Attach, and Playback Sequence

The PCM2906C is ready for setup when the reset sequence has finished and the USB device is attached. After a connection has been established by setup, the PCM2906C is ready to accept USB audio data. While waiting for the audio data (idle state), the analog output is set to bipolar zero (BPZ).

When receiving the audio data, the PCM2906C stores the first audio packet, which contains 1-ms audio data, into the internal storage buffer. The PCM2906C starts playing the audio data when detecting the next start-of-frame (SOF) packet, as illustrated in Figure 32.

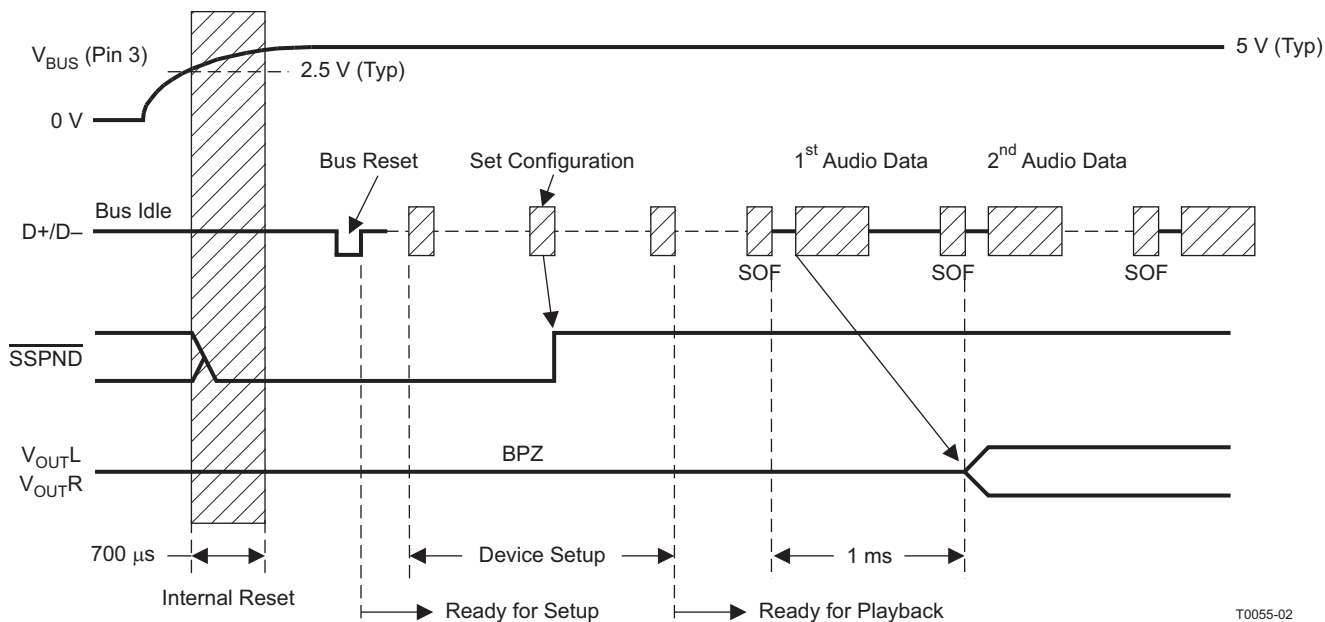

Figure 32. Initial Sequence

Play, Stop, and Detach Sequence

When the host finishes or aborts the playback, the PCM2906C stops playing after the last audio data have played, as shown in Figure 33.

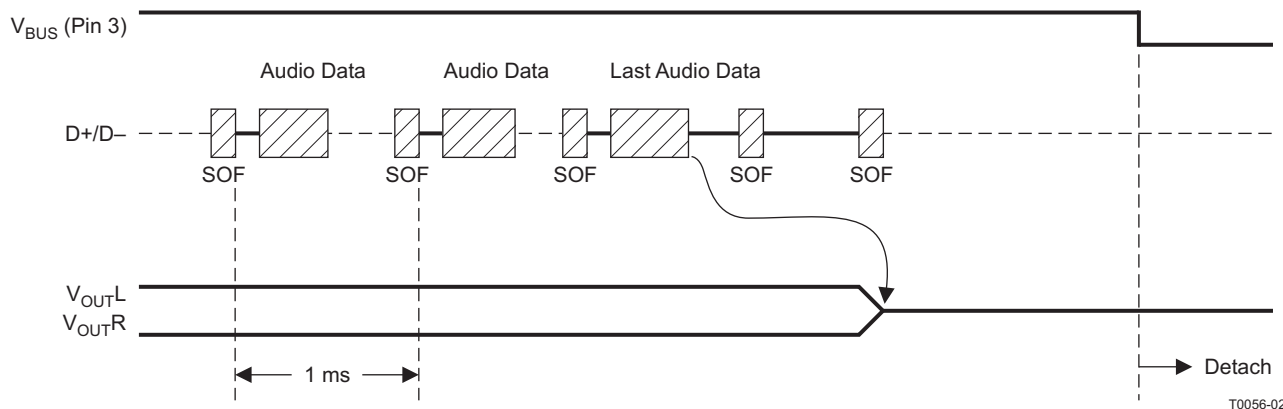

Figure 33. Play, Stop, and Detach Sequence

Record Sequence

The PCM2906C starts audio capture into the internal memory after receiving the SET_INTERFACE command, as shown in Figure 34.

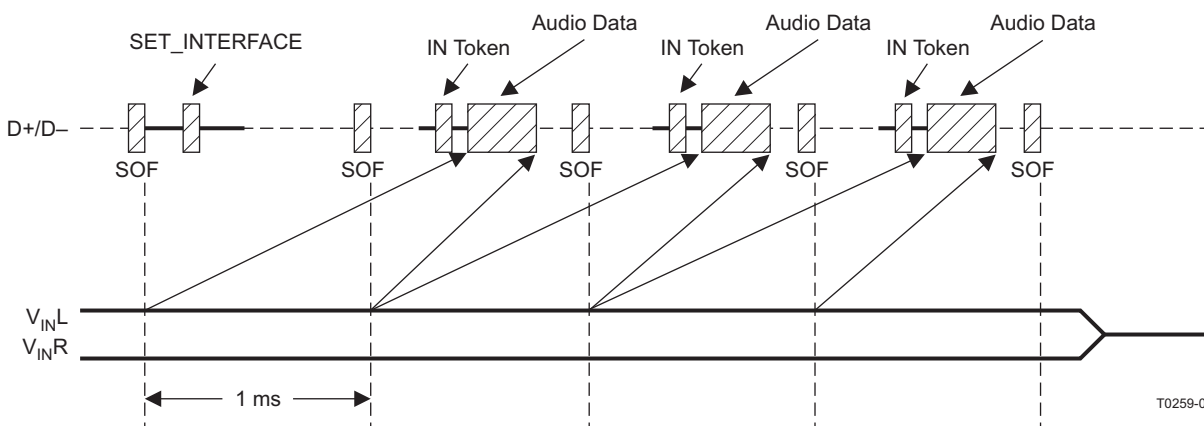

Figure 34. Record Sequence

Suspend and Resume Sequence

The PCM2906C enters the suspend state after a constant idle state on the USB bus (approximately 5 ms), as shown in Figure 35. While the PCM2906C enters the suspend state, the $\overline{\text{SSPND}}$ flag (pin 28) is asserted. The PCM2906C wakes up immediately upon detecting a non-idle state on the USB.

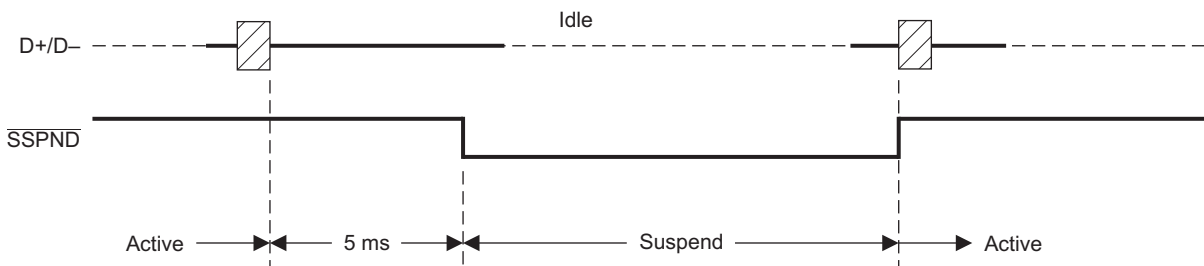
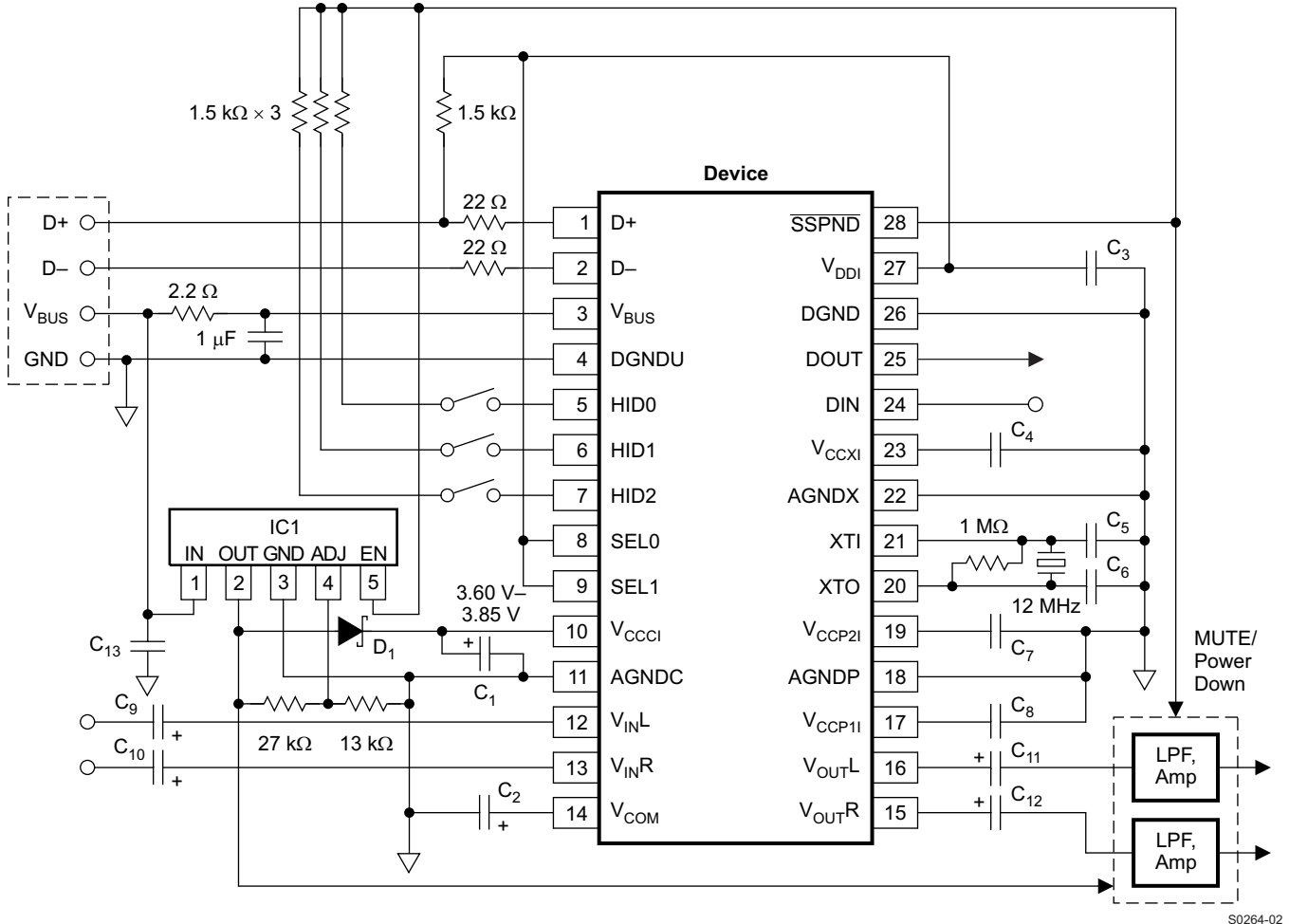

Figure 35. Suspend and Resume Sequence

APPLICATION INFORMATION

TYPICAL CIRCUIT CONNECTION 1

Figure 36 illustrates a typical circuit connection for a simple application. The circuit illustrated is for information only. The entire board design should be considered to meet the USB specification as a USB-compliant product.



S0264-02

NOTE: C₁, C₂: 10 μF
 C₃, C₄, C₇, C₈, C₁₃: 1 μF (These capacitors must be less than 2 μF.)
 C₅, C₆: 10 pF to 33 pF (depending on crystal resonator)
 C₉, C₁₀, C₁₁, C₁₂: The capacitance may vary depending on design.
 IC1: REG103xA-A (TI) or equivalent. Analog performance may vary depending on IC1.
 D₁: Schottky barrier diode (V_F ≤ 350 mV at 10 mA, I_R ≤ 2 μA at 4 V)

Figure 36. Bus-Powered Configuration for High-Performance Application

TYPICAL CIRCUIT CONNECTION 2

Figure 37 illustrates a typical circuit connection for a simple application. The circuit illustrated is for information only. The entire board design should be considered to meet the USB specification as a USB-compliant product.

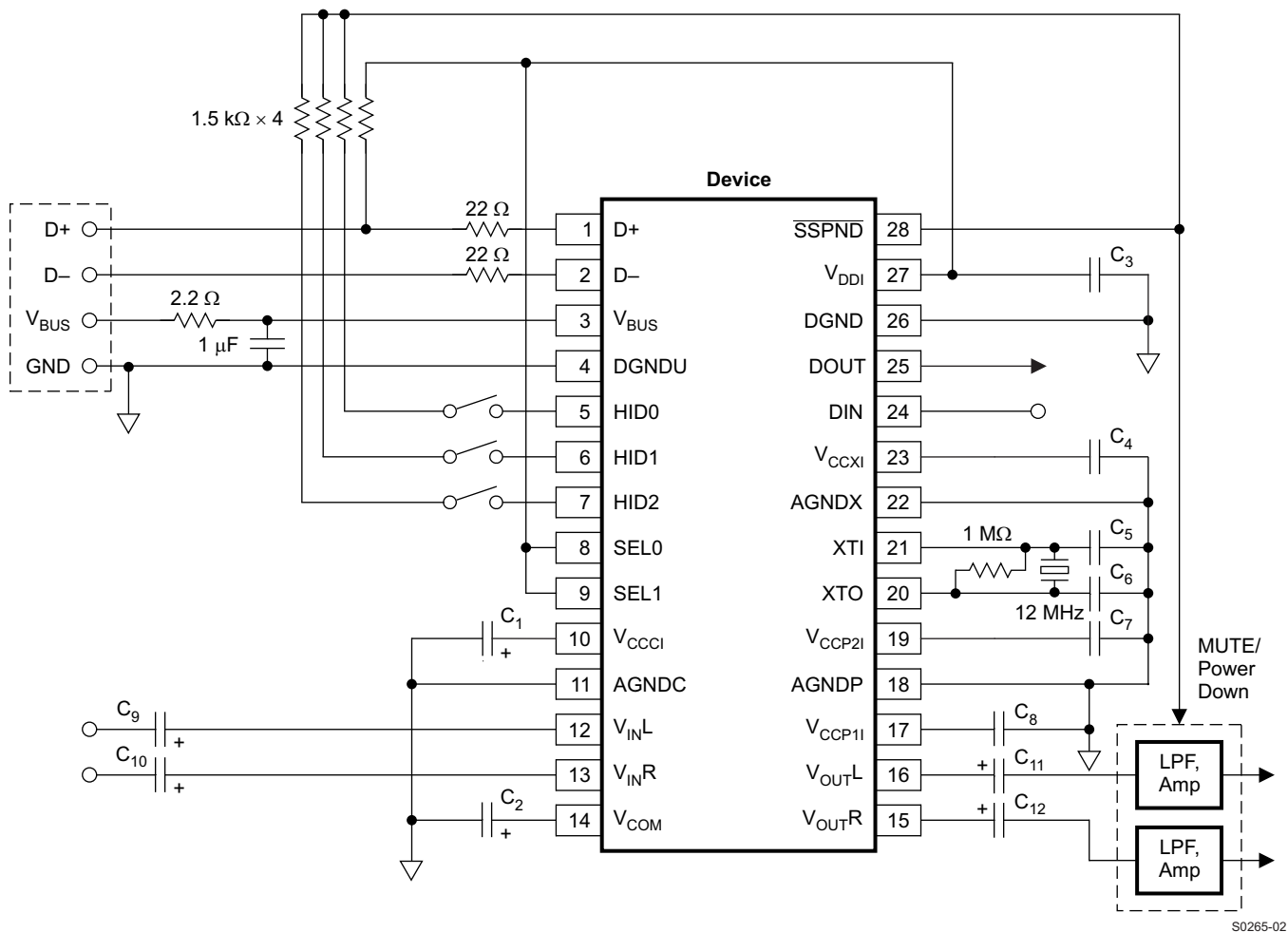

NOTE: C₁, C₂: 10 μF
 C₃, C₄, C₇, C₈: 1 μF (These capacitors must be less than 2 μF.)
 C₅, C₆: 10 pF to 33 pF (depending on crystal resonator)
 C₉, C₁₀, C₁₁, C₁₂: The capacitance may vary depending on design.
 In this case, the analog performance of the ADC may be degraded.

Figure 37. Bus-Powered Configuration

OPERATING ENVIRONMENT

For current information on the PCM2906C operating environment, see the *Updated Operating Environments for PCM270X, PCM290X Applications* application report, [SLAA374](#).

PACKAGING INFORMATION

Orderable Device	Status (1)	Package Type	Package Drawing	Pins	Package Qty	Eco Plan (2)	Lead/Ball Finish	MSL Peak Temp (3)	Op Temp (°C)	Top-Side Markings (4)	Samples
PCM2906CDB	ACTIVE	SSOP	DB	28	50	Green (RoHS & no Sb/Br)	CU NIPDAU	Level-1-260C-UNLIM	-25 to 85	PCM2906C	Samples
PCM2906CDBR	ACTIVE	SSOP	DB	28	2000	Green (RoHS & no Sb/Br)	CU NIPDAU	Level-1-260C-UNLIM	-25 to 85	PCM2906C	Samples

(1) The marketing status values are defined as follows:

ACTIVE: Product device recommended for new designs.

LIFEBUY: TI has announced that the device will be discontinued, and a lifetime-buy period is in effect.

NRND: Not recommended for new designs. Device is in production to support existing customers, but TI does not recommend using this part in a new design.

PREVIEW: Device has been announced but is not in production. Samples may or may not be available.

OBSOLETE: TI has discontinued the production of the device.

(2) Eco Plan - The planned eco-friendly classification: Pb-Free (RoHS), Pb-Free (RoHS Exempt), or Green (RoHS & no Sb/Br) - please check <http://www.ti.com/productcontent> for the latest availability information and additional product content details.

TBD: The Pb-Free/Green conversion plan has not been defined.

Pb-Free (RoHS): TI's terms "Lead-Free" or "Pb-Free" mean semiconductor products that are compatible with the current RoHS requirements for all 6 substances, including the requirement that lead not exceed 0.1% by weight in homogeneous materials. Where designed to be soldered at high temperatures, TI Pb-Free products are suitable for use in specified lead-free processes.

Pb-Free (RoHS Exempt): This component has a RoHS exemption for either 1) lead-based flip-chip solder bumps used between the die and package, or 2) lead-based die adhesive used between the die and leadframe. The component is otherwise considered Pb-Free (RoHS compatible) as defined above.

Green (RoHS & no Sb/Br): TI defines "Green" to mean Pb-Free (RoHS compatible), and free of Bromine (Br) and Antimony (Sb) based flame retardants (Br or Sb do not exceed 0.1% by weight in homogeneous material)

(3) MSL, Peak Temp. -- The Moisture Sensitivity Level rating according to the JEDEC industry standard classifications, and peak solder temperature.

(4) Multiple Top-Side Markings will be inside parentheses. Only one Top-Side Marking contained in parentheses and separated by a "~" will appear on a device. If a line is indented then it is a continuation of the previous line and the two combined represent the entire Top-Side Marking for that device.

Important Information and Disclaimer: The information provided on this page represents TI's knowledge and belief as of the date that it is provided. TI bases its knowledge and belief on information provided by third parties, and makes no representation or warranty as to the accuracy of such information. Efforts are underway to better integrate information from third parties. TI has taken and continues to take reasonable steps to provide representative and accurate information but may not have conducted destructive testing or chemical analysis on incoming materials and chemicals. TI and TI suppliers consider certain information to be proprietary, and thus CAS numbers and other limited information may not be available for release.

In no event shall TI's liability arising out of such information exceed the total purchase price of the TI part(s) at issue in this document sold by TI to Customer on an annual basis.

DB (R-PDSO-G**)

PLASTIC SMALL-OUTLINE

28 PINS SHOWN



- NOTES: A. All linear dimensions are in millimeters.
 B. This drawing is subject to change without notice.
 C. Body dimensions do not include mold flash or protrusion not to exceed 0,15.
 D. Falls within JEDEC MO-150

IMPORTANT NOTICE

Texas Instruments Incorporated and its subsidiaries (TI) reserve the right to make corrections, enhancements, improvements and other changes to its semiconductor products and services per JESD46, latest issue, and to discontinue any product or service per JESD48, latest issue. Buyers should obtain the latest relevant information before placing orders and should verify that such information is current and complete. All semiconductor products (also referred to herein as "components") are sold subject to TI's terms and conditions of sale supplied at the time of order acknowledgment.

TI warrants performance of its components to the specifications applicable at the time of sale, in accordance with the warranty in TI's terms and conditions of sale of semiconductor products. Testing and other quality control techniques are used to the extent TI deems necessary to support this warranty. Except where mandated by applicable law, testing of all parameters of each component is not necessarily performed.

TI assumes no liability for applications assistance or the design of Buyers' products. Buyers are responsible for their products and applications using TI components. To minimize the risks associated with Buyers' products and applications, Buyers should provide adequate design and operating safeguards.

TI does not warrant or represent that any license, either express or implied, is granted under any patent right, copyright, mask work right, or other intellectual property right relating to any combination, machine, or process in which TI components or services are used. Information published by TI regarding third-party products or services does not constitute a license to use such products or services or a warranty or endorsement thereof. Use of such information may require a license from a third party under the patents or other intellectual property of the third party, or a license from TI under the patents or other intellectual property of TI.

Reproduction of significant portions of TI information in TI data books or data sheets is permissible only if reproduction is without alteration and is accompanied by all associated warranties, conditions, limitations, and notices. TI is not responsible or liable for such altered documentation. Information of third parties may be subject to additional restrictions.

Resale of TI components or services with statements different from or beyond the parameters stated by TI for that component or service voids all express and any implied warranties for the associated TI component or service and is an unfair and deceptive business practice. TI is not responsible or liable for any such statements.

Buyer acknowledges and agrees that it is solely responsible for compliance with all legal, regulatory and safety-related requirements concerning its products, and any use of TI components in its applications, notwithstanding any applications-related information or support that may be provided by TI. Buyer represents and agrees that it has all the necessary expertise to create and implement safeguards which anticipate dangerous consequences of failures, monitor failures and their consequences, lessen the likelihood of failures that might cause harm and take appropriate remedial actions. Buyer will fully indemnify TI and its representatives against any damages arising out of the use of any TI components in safety-critical applications.

In some cases, TI components may be promoted specifically to facilitate safety-related applications. With such components, TI's goal is to help enable customers to design and create their own end-product solutions that meet applicable functional safety standards and requirements. Nonetheless, such components are subject to these terms.

No TI components are authorized for use in FDA Class III (or similar life-critical medical equipment) unless authorized officers of the parties have executed a special agreement specifically governing such use.

Only those TI components which TI has specifically designated as military grade or "enhanced plastic" are designed and intended for use in military/aerospace applications or environments. Buyer acknowledges and agrees that any military or aerospace use of TI components which have **not** been so designated is solely at the Buyer's risk, and that Buyer is solely responsible for compliance with all legal and regulatory requirements in connection with such use.

TI has specifically designated certain components as meeting ISO/TS16949 requirements, mainly for automotive use. In any case of use of non-designated products, TI will not be responsible for any failure to meet ISO/TS16949.

Products

Audio	www.ti.com/audio
Amplifiers	amplifier.ti.com
Data Converters	dataconverter.ti.com
DLP® Products	www.dlp.com
DSP	dsp.ti.com
Clocks and Timers	www.ti.com/clocks
Interface	interface.ti.com
Logic	logic.ti.com
Power Mgmt	power.ti.com
Microcontrollers	microcontroller.ti.com
RFID	www.ti-rfid.com
OMAP Applications Processors	www.ti.com/omap
Wireless Connectivity	www.ti.com/wirelessconnectivity

Applications

Automotive and Transportation	www.ti.com/automotive
Communications and Telecom	www.ti.com/communications
Computers and Peripherals	www.ti.com/computers
Consumer Electronics	www.ti.com/consumer-apps
Energy and Lighting	www.ti.com/energy
Industrial	www.ti.com/industrial
Medical	www.ti.com/medical
Security	www.ti.com/security
Space, Avionics and Defense	www.ti.com/space-avionics-defense
Video and Imaging	www.ti.com/video

TI E2E Community

e2e.ti.com