

TLV2342, TLV2342Y, TLV2344, TLV2344Y LinCMOS™ LOW-VOLTAGE HIGH-SPEED OPERATIONAL AMPLIFIERS

SLOS194 – FEBRUARY 1997

- Wide Range of Supply Voltages Over Specified Temperature Range:
–40°C to 85°C . . . 2 V to 8 V
- Fully Characterized at 3 V and 5 V
- Single-Supply Operation
- Common-Mode Input-Voltage Range Extends Below the Negative Rail and Up to $V_{DD} - 1$ V at 25°C
- Output Voltage Range Includes Negative Rail
- High Input Impedance . . . $10^{12} \Omega$ Typical
- ESD-Protection Circuitry
- Designed-In Latch-Up Immunity

description

The TLV234x operational amplifiers are in a family of devices that has been specifically designed for use in low-voltage single-supply applications. Unlike other products in this family designed primarily to meet aggressive power consumption specifications, the TLV234x was developed to offer ac performance approaching that of a BiFET operational amplifier while operating from a single-supply rail. At 3 V, the TLV234x has a typical slew rate of 2.1 V/ μ s and 790-kHz unity-gain bandwidth.

Each amplifier is fully functional down to a minimum supply voltage of 2 V and is fully characterized, tested, and specified at both 3-V and 5-V power supplies over a temperature range of –40°C to 85°C. The common-mode input voltage range includes the negative rail and extends to within 1 V of the positive rail.

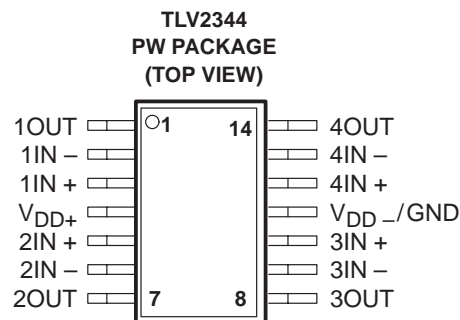
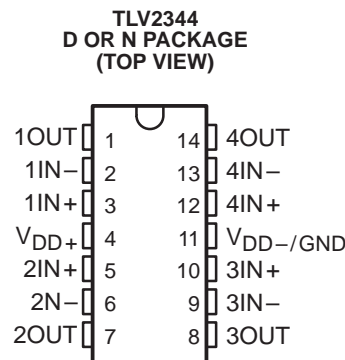
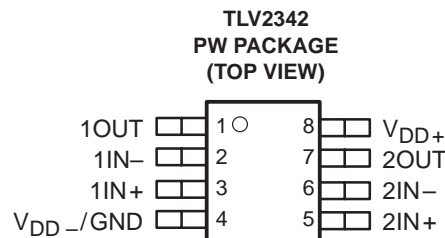
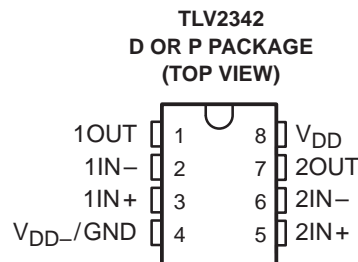

AVAILABLE OPTIONS

T _A	V _{IO} max AT 25°C	PACKAGED DEVICES				CHIP FORMS [§] (Y)
		SMALL OUTLINE [†] (D)	PLASTIC DIP (N)	PLASTIC DIP (P)	TSSOP [‡] (PW)	
–40°C to 85°C	9 mV	TLV2342ID	—	TLV2342IP	TLV2342IPWLE	TLV2342Y
	10 mV	TLV2344ID	TLV2344IN	—	TLV2344IPWLE	TLV2344Y

[†] The D package is available taped and reeled. Add R suffix to the device type (e.g., TLV2342IDR).

[‡] The PW package is only available left-end taped and reeled (e.g., TLV2342IPWLE).

[§] Chip forms are tested at 25°C only.



Please be aware that an important notice concerning availability, standard warranty, and use in critical applications of Texas Instruments semiconductor products and disclaimers thereto appears at the end of this data sheet.

LinCMOS is a trademark of Texas Instruments Incorporated.

PRODUCTION DATA information is current as of publication date. Products conform to specifications per the terms of Texas Instruments standard warranty. Production processing does not necessarily include testing of all parameters.

 **TEXAS
INSTRUMENTS**

POST OFFICE BOX 655303 • DALLAS, TEXAS 75265

Copyright © 1997, Texas Instruments Incorporated

TLV2342, TLV2342Y, TLV2344, TLV2344Y LinCMOS™ LOW-VOLTAGE HIGH-SPEED OPERATIONAL AMPLIFIERS

SLOS194 – FEBRUARY 1997

description (continued)

Low-voltage and low-power operation has been made possible by using the Texas Instruments silicon-gate LinCMOS technology. The LinCMOS process also features extremely high input impedance and ultra-low input bias currents. These parameters combined with good ac performance make the TLV234x effectual in applications such as high-frequency filters and wide-bandwidth sensors.

To facilitate the design of small portable equipment, the TLV234x is made available in a wide range of package options, including the small-outline and thin-shrink small-outline packages (TSSOP). The TSSOP package has significantly reduced dimensions compared to a standard surface-mount package. Its maximum height of only 1.1 mm makes it particularly attractive when space is critical.

The device inputs and outputs are designed to withstand -100-mA currents without sustaining latch-up. The TLV234x incorporates internal ESD-protection circuits that prevents functional failures at voltages up to 2000 V as tested under MIL-PRF-38535, Method 3015.2; however, care should be exercised in handling these devices as exposure to ESD may result in the degradation of the device parametric performance.

TLV2342Y chip information

This chip, when properly assembled, displays characteristics similar to the TLV2342. Thermal compression or ultrasonic bonding may be used on the doped-aluminum bonding pads. Chips may be mounted with conductive epoxy or a gold-silicon preform.

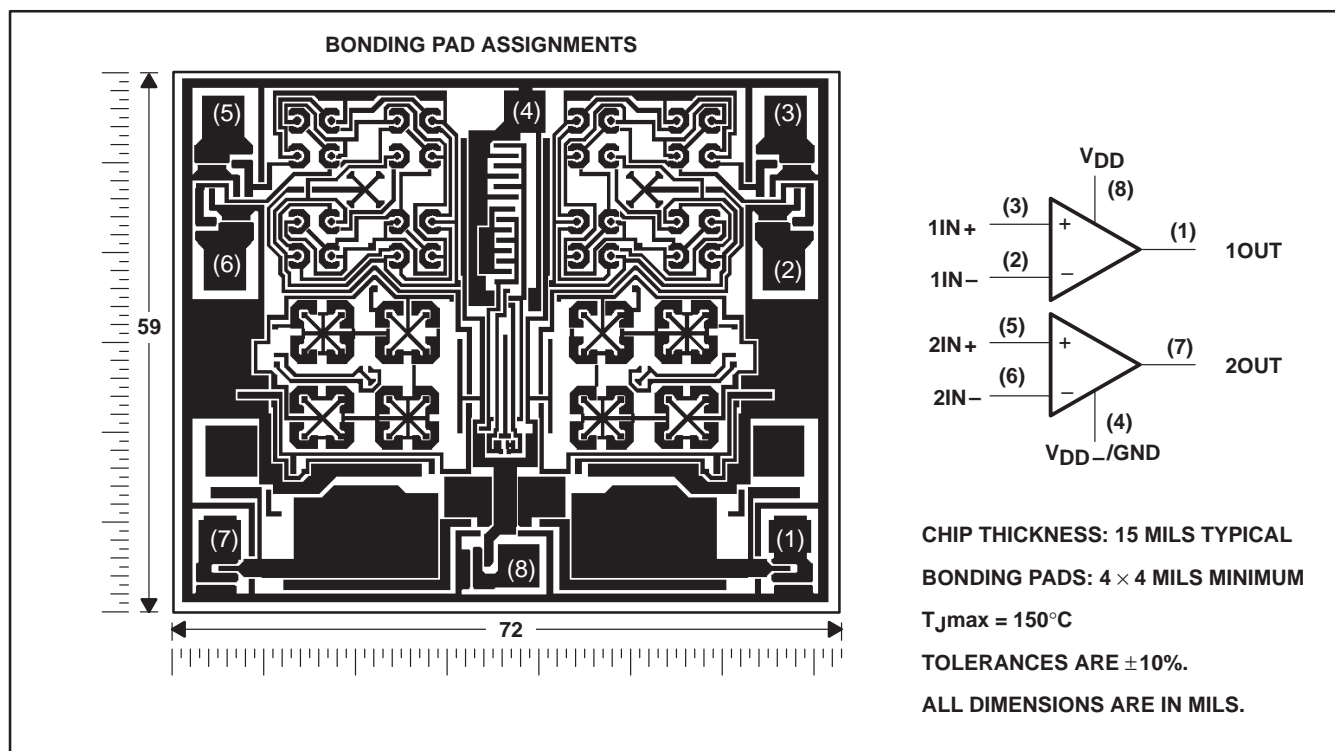

TLV2344Y chip information

This chip, when properly assembled, displays characteristics similar to the TLV2344. Thermal compression or ultrasonic bonding may be used on the doped-aluminum bonding pads. Chips may be mounted with conductive epoxy or a gold-silicon preform.

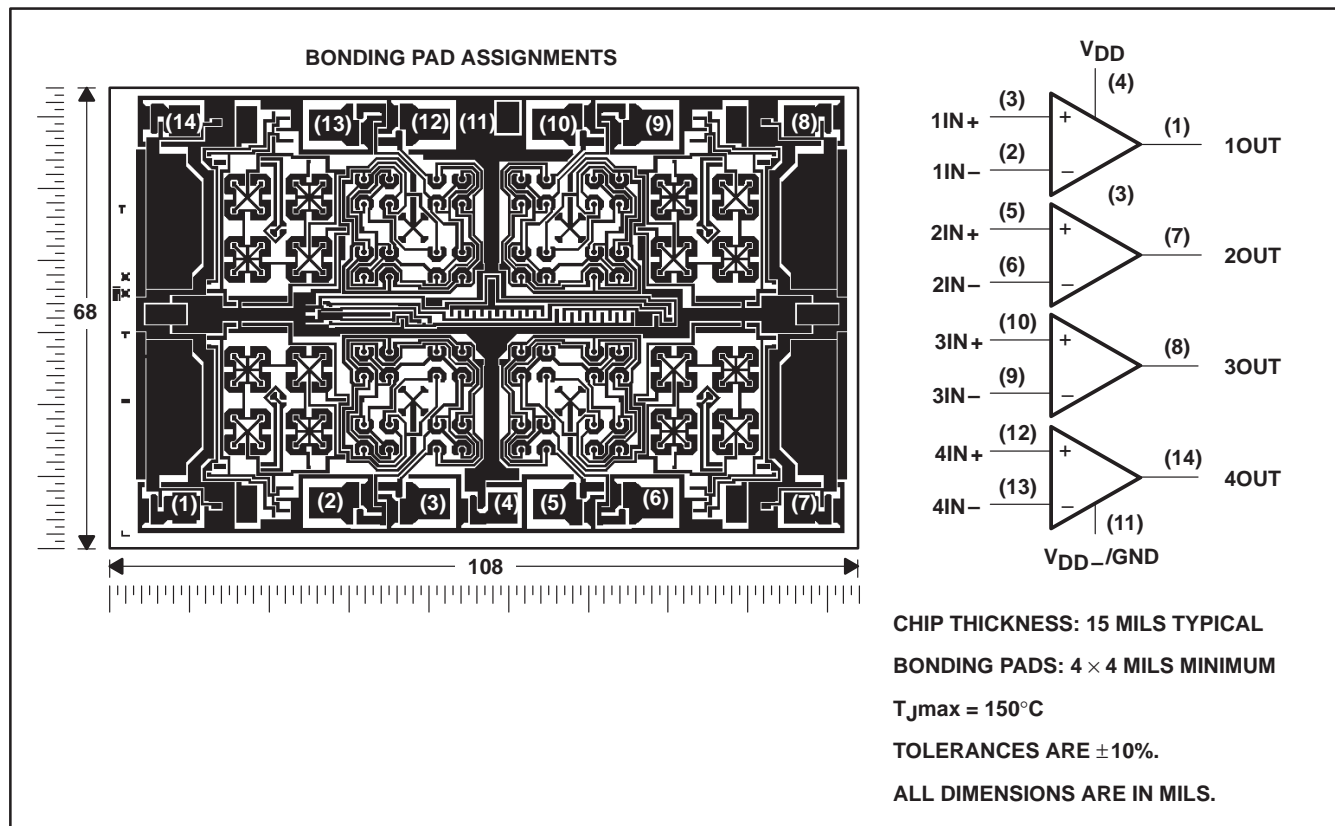

TLV2342, TLV2342Y, TLV2344, TLV2344Y LinCMOS™ LOW-VOLTAGE HIGH-SPEED OPERATIONAL AMPLIFIERS

SLOS194 – FEBRUARY 1997

equivalent schematic (each amplifier)

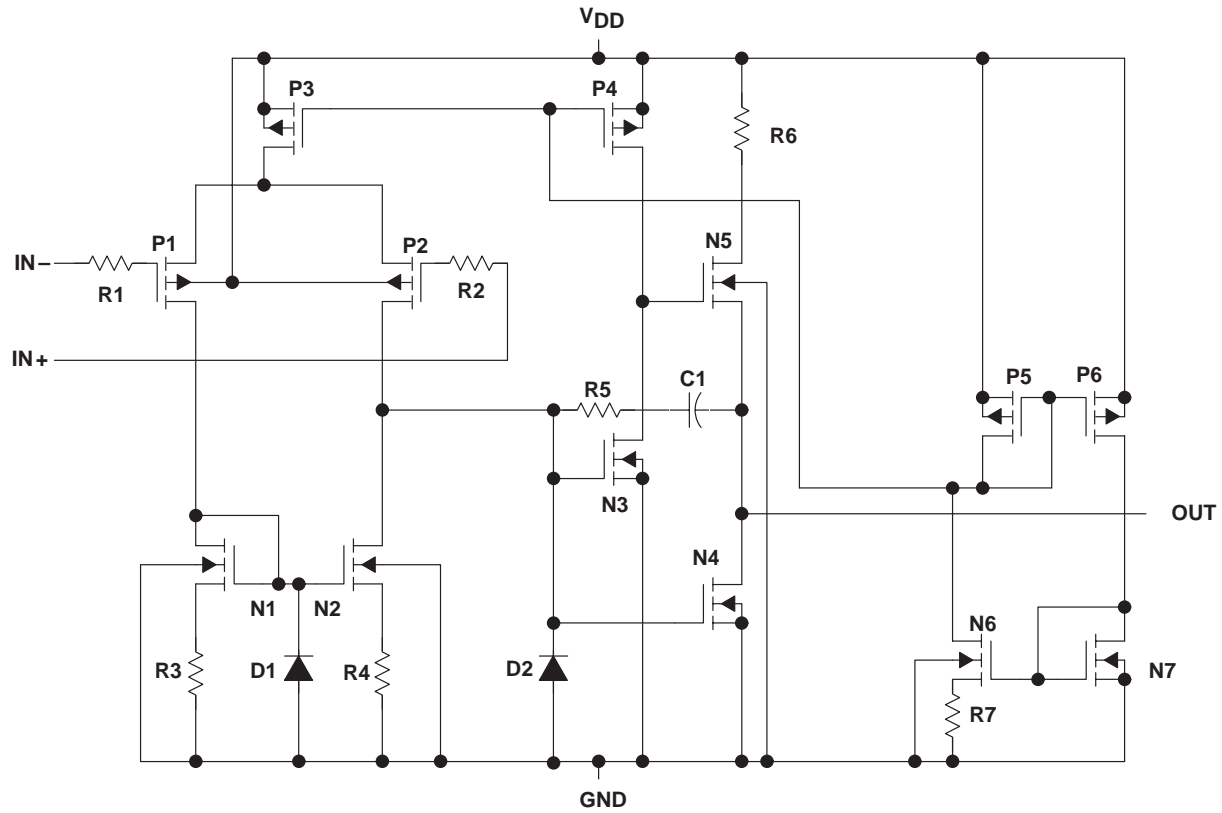

ACTUAL DEVICE COMPONENT COUNT†		
COMPONENT	TLV2342	TLV2344
Transistors	54	108
Resistors	14	28
Diodes	4	8
Capacitors	2	4

† Includes both amplifiers and all ESD, bias, and trim circuitry.

absolute maximum ratings over operating free-air temperature (unless otherwise noted)†

Supply voltage, V_{DD} (see Note 1)	8 V
Differential input voltage, V_{ID} (see Note 2)	$V_{DD} \pm$
Input voltage range, V_I (any input)	-0.3 V to V_{DD}
Input current, I_I	± 5 mA
Output current, I_O	± 30 mA
Duration of short-circuit current at (or below) $T_A = 25^\circ\text{C}$ (see Note 3)	unlimited
Continuous total dissipation	See Dissipation Rating Table
Operating free-air temperature range, T_A	-40°C to 85°C
Storage temperature range	-65°C to 150°C
Lead temperature 1,6 mm (1/16 inch) from case for 10 seconds	260°C

† Stresses beyond those listed under “absolute maximum ratings” may cause permanent damage to the device. These are stress ratings only, and functional operation of the device at these or any other conditions beyond those indicated under “recommended operating conditions” is not implied. Exposure to absolute-maximum-rated conditions for extended periods may affect device reliability.

- NOTES:
1. All voltage values, except differential voltages, are with respect to network ground.
 2. Differential voltages are at the noninverting input with respect to the inverting input.
 3. The output may be shorted to either supply. Temperature and/or supply voltages must be limited to ensure that the maximum dissipation rating is not exceeded (see application selection).

DISSIPATION RATING TABLE

PACKAGE	$T_A \leq 25^\circ\text{C}$ POWER RATING	DERATING FACTOR ABOVE $T_A = 25^\circ\text{C}$	$T_A = 85^\circ\text{C}$ POWER RATING
D-8	725 mW	5.8 mW/ $^\circ\text{C}$	377 mW
D-14	950 mW	7.6 mW/ $^\circ\text{C}$	494 mW
N	1575 mW	5.6 mW/ $^\circ\text{C}$	364 mW
P	1000 mW	8.0 mW/ $^\circ\text{C}$	520 mW
PW-8	525 mW	4.2 mW/ $^\circ\text{C}$	273 mW
PW-14	700 mW	6.0 mW/ $^\circ\text{C}$	340 mW

recommended operating conditions

		MIN	MAX	UNIT
Supply voltage, V_{DD}		2	8	V
Common-mode input voltage, V_{IC}	$V_{DD} = 3$ V	-0.2	1.8	V
	$V_{DD} = 5$ V	-0.2	3.8	
Operating free-air temperature, T_A		-40	85	$^\circ\text{C}$

TLV2342, TLV2342Y, TLV2344, TLV2344Y
LinCMOS™ LOW-VOLTAGE HIGH-SPEED
OPERATIONAL AMPLIFIERS

SLOS194 – FEBRUARY 1997

TLV2342I electrical characteristics at specified free-air temperature

PARAMETER	TEST CONDITIONS	T _A †	TLV2342I						UNIT
			V _{DD} = 3 V			V _{DD} = 5 V			
			MIN	TYP	MAX	MIN	TYP	MAX	
V _{IO} Input offset voltage	V _O = 1 V, V _{IC} = 1 V, R _S = 50 Ω, R _L = 10 kΩ	25°C	0.6		9	1.1		9	mV
		Full range	11			11			
α _{VIO} Average temperature coefficient of input offset voltage		25°C to 85°C	2.7			2.7			μV/°C
I _{IO} Input offset current (see Note 4)	V _O = 1 V, V _{IC} = 1 V	25°C	0.1			0.1			pA
		85°C	22		1000	24		1000	
I _{IB} Input bias current (see Note 4)	V _O = 1 V, V _{IC} = 1 V	25°C	0.6			0.6			pA
		85°C	175		2000	200		2000	
V _{ICR} Common-mode input voltage range (see Note 5)		25°C	-0.2 to 2	-0.3 to 2.3		-0.2 to 4	-0.3 to 4.2		V
		Full range	-0.2 to 1.8			-0.2 to 3.8			V
V _{OH} High-level output voltage	V _{IC} = 1 V, V _{ID} = 100 mV, I _{OH} = -1 mA	25°C	1.75	1.9		3.2	3.7		V
		Full range	1.7			3			
V _{OL} Low-level output voltage	V _{IC} = 1 V, V _{ID} = -100 mV, I _{OL} = 1 mA	25°C	120		150	90		150	mV
		Full range	190			190			
A _{VD} Large-signal differential voltage amplification	V _{IC} = 1 V, R _L = 10 kΩ, See Note 6	25°C	3	11		5	23		V/mV
		Full range	2			3.5			
CMRR Common-mode rejection ratio	V _O = 1 V, V _{IC} = V _{ICRmin} , R _S = 50 Ω	25°C	65	78		65	80		dB
		Full range	60			60			
k _{SVR} Supply-voltage rejection ratio (ΔV _{DD} /ΔV _{IO})	V _{IC} = 1 V, V _O = 1 V, R _S = 50 Ω	25°C	70	95		70	95		dB
		Full range	65			65			
I _{DD} Supply current	V _O = 1 V, V _{IC} = 1 V, No load	25°C	0.65		3	1.4		3.2	mA
		Full range	4			4.4			

† Full range is -40°C to 85°C.

- NOTES: 4. The typical values of input bias current and input offset current below 5 pA are determined mathematically.
5. This range also applies to each input individually.
6. At V_{DD} = 5 V, V_O = 0.25 V to 2 V; at V_{DD} = 3 V, V_O = 0.5 V to 1.5 V.



TLV2342I operating characteristics at specified free-air temperature, $V_{DD} = 3\text{ V}$

PARAMETER	TEST CONDITIONS	T_A	TLV2342I			UNIT
			MIN	TYP	MAX	
SR Slew rate at unity gain	$V_{IC} = 1\text{ V}$, $R_L = 10\text{ k}\Omega$, See Figure 34	$V_I(PP) = 1\text{ V}$, $C_L = 20\text{ pF}$, See Figure 34	25°C	2.1		V/ μ s
			85°C	1.7		
V_n Equivalent input noise voltage	$f = 1\text{ kHz}$, See Figure 35	$R_S = 20\ \Omega$, 25°C	25		nV/ $\sqrt{\text{Hz}}$	
B _{OM} Maximum output-swing bandwidth	$V_O = V_{OH}$, $R_L = 10\text{ k}\Omega$, See Figure 34	$C_L = 20\text{ pF}$, See Figure 34	25°C	170		kHz
			85°C	145		
B ₁ Unity-gain bandwidth	$V_I = 10\text{ mV}$, $R_L = 10\text{ k}\Omega$, See Figure 36	$C_L = 20\text{ pF}$, See Figure 36	25°C	790		kHz
			85°C	690		
ϕ_m Phase margin	$V_I = 10\text{ mV}$, $C_L = 20\text{ pF}$, See Figure 36	$f = B_1$, $R_L = 10\text{ k}\Omega$	-40°C	53°		
			25°C	49°		
			85°C	47°		

TLV2342I operating characteristics at specified free-air temperature, $V_{DD} = 5\text{ V}$

PARAMETER	TEST CONDITIONS	T_A	TLV2342I			UNIT
			MIN	TYP	MAX	
SR Slew rate at unity gain	$V_{IC} = 1\text{ V}$, $R_L = 10\text{ k}\Omega$, $C_L = 20\text{ pF}$, See Figure 34	$V_I(PP) = 1\text{ V}$	25°C	3.6		V/ μ s
			85°C	2.8		
		$V_I(PP) = 2.5\text{ V}$	25°C	2.9		
			85°C	2.3		
V_n Equivalent input noise voltage	$f = 1\text{ kHz}$, See Figure 35	$R_S = 20\ \Omega$, 25°C	25		nV/ $\sqrt{\text{Hz}}$	
B _{OM} Maximum output-swing bandwidth	$V_O = V_{OH}$, $R_L = 10\text{ k}\Omega$, See Figure 34	$C_L = 20\text{ pF}$, See Figure 34	25°C	320		kHz
			85°C	250		
B ₁ Unity-gain bandwidth	$V_I = 10\text{ mV}$, $R_L = 10\text{ k}\Omega$, See Figure 36	$C_L = 20\text{ pF}$, See Figure 36	25°C	1.7		kHz
			85°C	1.2		
ϕ_m Phase margin	$V_I = 10\text{ mV}$, $C_L = 20\text{ pF}$, See Figure 36	$f = B_1$, $R_L = 10\text{ k}\Omega$	-40°C	49°		
			25°C	46°		
			85°C	43°		

TLV2342, TLV2342Y, TLV2344, TLV2344Y
LinCMOS™ LOW-VOLTAGE HIGH-SPEED
OPERATIONAL AMPLIFIERS

SLOS194 – FEBRUARY 1997

TLV2344I electrical characteristics at specified free-air temperature

PARAMETER	TEST CONDITIONS	T _A †	TLV2344I						UNIT
			V _{DD} = 3 V			V _{DD} = 5 V			
			MIN	TYP	MAX	MIN	TYP	MAX	
V _{IO} Input offset voltage	V _O = 1 V, V _{IC} = 1 V, R _S = 50 Ω, R _L = 10 kΩ	25°C	1.1		10	1.1		10	mV
		Full range	12			12			
α _{VIO} Average temperature coefficient of input offset voltage		25°C to 85°C	2.7			2.7			μV/°C
I _{IO} Input offset current (see Note 4)	V _O = 1 V, V _{IC} = 1 V	25°C	0.1			0.1			pA
		85°C	22	1000		24	1000		
I _{IB} Input bias current (see Note 4)	V _O = 1 V, V _{IC} = 1 V	25°C	0.6			0.6			pA
		85°C	175	2000		200	2000		
V _{ICR} Common-mode input voltage range (see Note 5)		25°C	-0.2 to 2	-0.3 to 2.3		-0.2 to 4	-0.3 to 4.2		V
		Full range	-0.2 to 1.8			-0.2 to 3.8			V
V _{OH} High-level output voltage	V _{IC} = 1 V, V _{ID} = 100 mV, I _{OH} = -1 mA	25°C	1.75	1.9		3.2	3.7		V
		Full range	1.7			3			
V _{OL} Low-level output voltage	V _{IC} = 1 V, V _{ID} = -100 mV, I _{OL} = 1 mA	25°C	120		150	90		150	mV
		Full range	190			190			
A _{VD} Large-signal differential voltage amplification	V _{IC} = 1 V, R _L = 10 kΩ, See Note 6	25°C	3	11		5	23		V/mV
		Full range	2			3.5			
CMRR Common-mode rejection ratio	V _O = 1 V, V _{IC} = V _{ICRmin} , R _S = 50 Ω	25°C	65	78		65	80		dB
		Full range	60			60			
k _{SVR} Supply-voltage rejection ratio (ΔV _{DD} /ΔV _{IO})	V _{IC} = 1 V, V _O = 1 V, R _S = 50 Ω	25°C	70	95		70	95		dB
		Full range	65			65			
I _{DD} Supply current	V _O = 1 V, V _{IC} = 1 V, No load	25°C	1.3		6	2.7		6.4	mA
		Full range	8			8.8			

† Full range is -40°C to 85°C.

NOTES: 4. The typical values of input bias current and input offset current below 5 pA are determined mathematically.

5. This range also applies to each input individually.

6. At V_{DD} = 5 V, V_O = 0.25 V to 2 V; at V_{DD} = 3 V, V_O = 0.5 V to 1.5 V.



TLV2344I operating characteristics at specified free-air temperature, $V_{DD} = 3\text{ V}$

PARAMETER	TEST CONDITIONS	T_A	TLV2344I			UNIT
			MIN	TYP	MAX	
SR Slew rate at unity gain	$V_{IC} = 1\text{ V}$, $R_L = 10\text{ k}\Omega$, See Figure 34	$V_{I(PP)} = 1\text{ V}$, $C_L = 20\text{ pF}$	25°C	2.1		V/ μ s
			85°C	1.7		
V_n Equivalent input noise voltage	$f = 1\text{ kHz}$, See Figure 35	$R_S = 20\ \Omega$	25°C	25		nV/ $\sqrt{\text{Hz}}$
B _{OM} Maximum output-swing bandwidth	$V_O = V_{OH}$, $R_L = 10\text{ k}\Omega$	$C_L = 20\text{ pF}$, See Figure 34	25°C	170		kHz
			85°C	145		
B ₁ Unity-gain bandwidth	$V_I = 10\text{ mV}$, $R_L = 10\text{ k}\Omega$	$C_L = 20\text{ pF}$, See Figure 36	25°C	790		kHz
			85°C	690		
ϕ_m Phase margin	$V_I = 10\text{ mV}$, $C_L = 20\text{ pF}$, See Figure 36	$f = B_1$, $R_L = 10\text{ k}\Omega$	-40°C	53°		
			25°C	49°		
			85°C	47°		

TLV2344I operating characteristics at specified free-air temperature, $V_{DD} = 5\text{ V}$

PARAMETER	TEST CONDITIONS	T_A	TLV2344I			UNIT
			MIN	TYP	MAX	
SR Slew rate at unity gain	$V_{IC} = 1\text{ V}$, $R_L = 10\text{ k}\Omega$, $C_L = 20\text{ pF}$, See Figure 34	$V_{I(PP)} = 1\text{ V}$	25°C	3.6		V/ μ s
			85°C	2.8		
		$V_{I(PP)} = 2.5\text{ V}$	25°C	2.9		
			85°C	2.3		
V_n Equivalent input noise voltage	$f = 1\text{ kHz}$, See Figure 35	$R_S = 20\ \Omega$	25°C	25		nV/ $\sqrt{\text{Hz}}$
B _{OM} Maximum output-swing bandwidth	$V_O = V_{OH}$, $R_L = 10\text{ k}\Omega$	$C_L = 20\text{ pF}$, See Figure 34	25°C	320		kHz
			85°C	250		
B ₁ Unity-gain bandwidth	$V_I = 10\text{ mV}$, $R_L = 10\text{ k}\Omega$	$C_L = 20\text{ pF}$, See Figure 36	25°C	1.7		MHz
			85°C	1.2		
ϕ_m Phase margin	$V_I = 10\text{ mV}$, $C_L = 20\text{ pF}$, See Figure 36	$f = B_1$, $R_L = 10\text{ k}\Omega$	-40°C	49°		
			25°C	46°		
			85°C	43°		

TLV2342, TLV2342Y, TLV2344, TLV2344Y
LinCMOS™ LOW-VOLTAGE HIGH-SPEED
OPERATIONAL AMPLIFIERS

SLOS194 – FEBRUARY 1997

TLV2342Y electrical characteristics, $T_A = 25^\circ\text{C}$

PARAMETER	TEST CONDITIONS	TLV2342Y						UNIT
		$V_{DD} = 3\text{ V}$			$V_{DD} = 5\text{ V}$			
		MIN	TYP	MAX	MIN	TYP	MAX	
V_{IO} Input offset voltage	$V_O = 1\text{ V}$, $R_S = 50\ \Omega$, $V_{IC} = 1\text{ V}$, $R_L = 10\text{ k}\Omega$	0.6			1.1			mV
I_{IO} Input offset current (see Note 4)	$V_O = 1\text{ V}$, $V_{IC} = 1\text{ V}$	0.1			0.1			pA
I_{IB} Input bias current (see Note 4)	$V_O = 1\text{ V}$, $V_{IC} = 1\text{ V}$	0.6			0.6			pA
V_{ICR} Common-mode input voltage range (see Note 5)		-0.3 to 2.3			-0.3 to 4.2			V
V_{OH} High-level output voltage	$V_{IC} = 1\text{ V}$, $I_{OH} = -1\text{ mA}$, $V_{ID} = 100\text{ mV}$	1.9			3.7			V
V_{OL} Low-level output voltage	$V_{IC} = 1\text{ V}$, $I_{OL} = 1\text{ mA}$, $V_{ID} = 100\text{ mV}$	120			90			mV
A_{VD} Large-signal differential voltage amplification	$V_{IC} = 1\text{ V}$, See Note 6, $R_L = 10\text{ k}\Omega$	11			23			V/mV
CMRR Common-mode rejection ratio	$V_O = 1\text{ V}$, $R_S = 50\ \Omega$, $V_{IC} = V_{ICRmin}$	78			80			dB
k_{SVR} Supply-voltage rejection ratio ($\Delta V_{DD}/\Delta V_{ID}$)	$V_O = 1\text{ V}$, $R_S = 50\ \Omega$, $V_{IC} = 1\text{ V}$	95			95			dB
I_{DD} Supply current	$V_O = 1\text{ V}$, No load, $V_{IC} = 1\text{ V}$	0.65			1.4			mA

- NOTES: 4. The typical values of input bias current and input offset current below 5 pA are determined mathematically.
5. This range also applies to each input individually.
6. At $V_{DD} = 5\text{ V}$, $V_O = 0.25\text{ V}$ to 2 V ; at $V_{DD} = 3\text{ V}$, $V_O = 0.5\text{ V}$ to 1.5 V .



TLV2344Y electrical characteristics, $T_A = 25^\circ\text{C}$

PARAMETER	TEST CONDITIONS	TLV2344Y						UNIT	
		$V_{DD} = 3\text{ V}$			$V_{DD} = 5\text{ V}$				
		MIN	TYP	MAX	MIN	TYP	MAX		
V_{IO} Input offset voltage	$V_O = 1\text{ V}$, $R_L = 10\text{ k}\Omega$	$V_{IC} = 1\text{ V}$, $R_L = 10\text{ k}\Omega$	1.1			1.1			mV
I_{IO} Input offset current (see Note 4)	$V_O = 1\text{ V}$	$V_{IC} = 1\text{ V}$	0.1			0.1			pA
I_{IB} Input bias current (see Note 4)	$V_O = 1\text{ V}$	$V_{IC} = 1\text{ V}$	0.6			0.6			pA
V_{ICR} Common-mode input voltage range (see Note 5)			-0.3 to 2.3			-0.3 to 4.2			V
V_{OH} High-level output voltage	$V_{IC} = 1\text{ V}$, $I_{OH} = -1\text{ mA}$	$V_{ID} = 100\text{ mV}$	1.9			3.7			V
V_{OL} Low-level output voltage	$V_{IC} = 1\text{ V}$, $I_{OL} = 1\text{ mA}$	$V_{ID} = -100\text{ mV}$	120			90			mV
A_{VD} Large-signal differential voltage amplification	$V_{IC} = 1\text{ V}$, See Note 6	$R_L = 10\text{ k}\Omega$	11			23			V/mV
CMRR Common-mode rejection ratio	$V_O = 1\text{ V}$, $R_S = 50\ \Omega$	$V_{IC} = V_{ICRmin}$	78			80			dB
k_{SVR} Supply-voltage rejection ratio ($\Delta V_{DD}/\Delta V_{ID}$)	$V_O = 1\text{ V}$, $R_S = 50\ \Omega$	$V_{IC} = 1\text{ V}$	95			95			dB
I_{DD} Supply current	$V_O = 1\text{ V}$, No load	$V_{IC} = 1\text{ V}$	1.3			2.7			μA

- NOTES: 4. The typical values of input bias current and input offset current below 5 pA are determined mathematically.
 5. This range also applies to each input individually.
 6. At $V_{DD} = 5\text{ V}$, $V_O = 0.25\text{ V}$ to 2 V ; at $V_{DD} = 3\text{ V}$, $V_O = 0.5\text{ V}$ to 1.5 V .

TLV2342, TLV2342Y, TLV2344, TLV2344Y
LinCMOS™ LOW-VOLTAGE HIGH-SPEED
OPERATIONAL AMPLIFIERS

SLOS194 – FEBRUARY 1997

TYPICAL CHARACTERISTICS

Table of Graphs

			FIGURE
V_{IO}	Input offset voltage	Distribution	1 – 4
α_{VIO}	Input offset voltage temperature coefficient	Distribution	5 – 8
I_{IB}	Input bias current	vs Free-air temperature	9
I_{IO}	Input offset current	vs Free-air temperature	9
V_{IC}	Common-mode input voltage	vs Supply voltage	10
V_{OH}	High-level output voltage	vs High-level output current	11
		vs Supply voltage	12
		vs Free-air temperature	13
V_{OL}	Low-level output voltage	vs Common-mode input voltage	14
		vs Free-air temperature	15, 16
		vs Differential input voltage	17
		vs Low-level output current	18
A_{VD}	Large-signal differential voltage amplification	vs Supply voltage	19
		vs Free-air temperature	20, 21
		vs Frequency	22, 23
I_{DD}	Supply current	vs Supply voltage	24
		vs Free-air temperature	25
SR	Slew rate	vs Supply voltage	26
		vs Free-air temperature	27
$V_{O(PP)}$	Maximum peak-to-peak output voltage	vs Frequency	28
B_1	Unity-gain bandwidth	vs Supply voltage	29
		vs Free-air temperature	30
ϕ_m	Phase margin	vs Supply voltage	31
		vs Free-air temperature	32
		vs Load capacitance	33
	Phase shift	vs Frequency	22, 23
V_n	Equivalent input noise voltage	vs Frequency	34



TYPICAL CHARACTERISTICS

DISTRIBUTION OF TLV2342
 INPUT OFFSET VOLTAGE

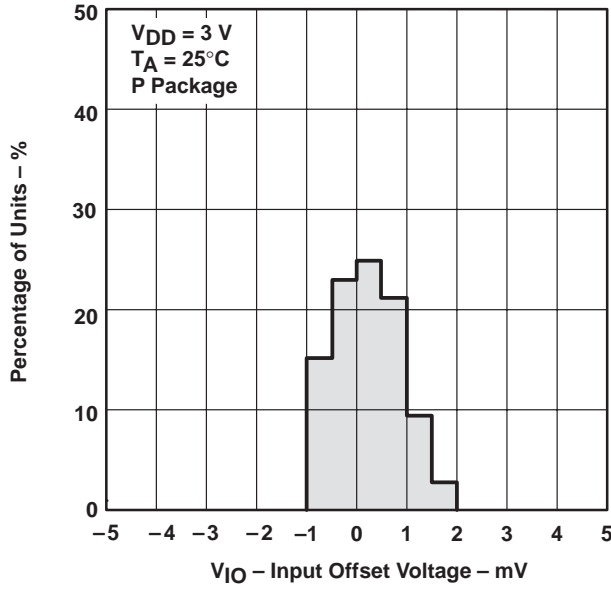

Figure 1

DISTRIBUTION OF TLV2342
 INPUT OFFSET VOLTAGE

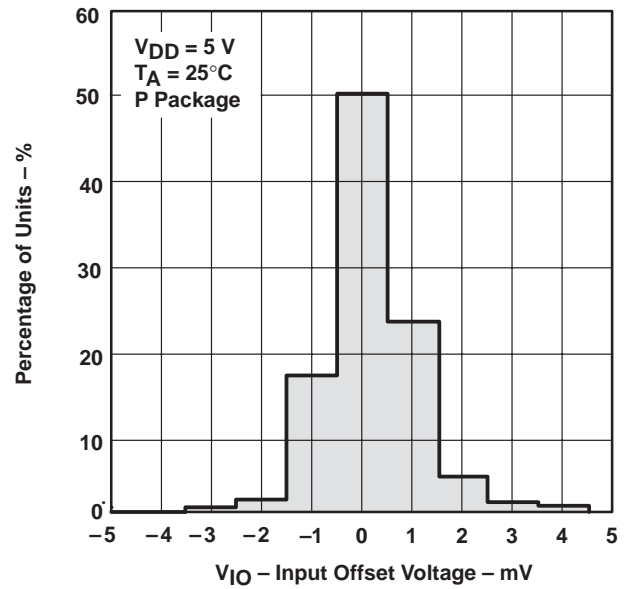

Figure 2

DISTRIBUTION OF TLV2344
 INPUT OFFSET VOLTAGE

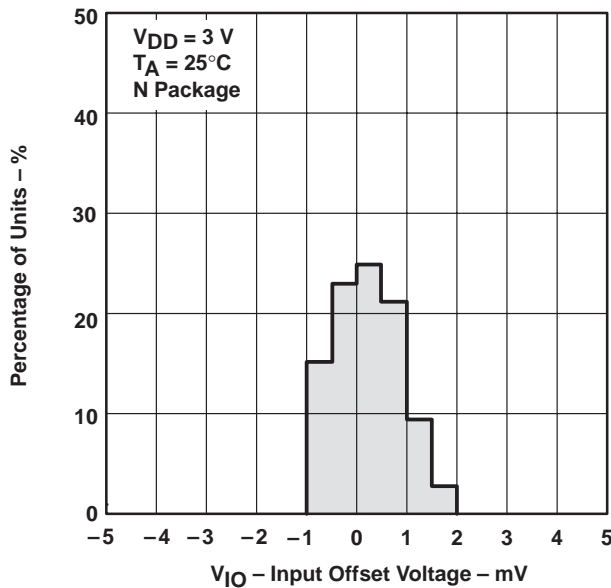

Figure 3

DISTRIBUTION OF TLV2344
 INPUT OFFSET VOLTAGE

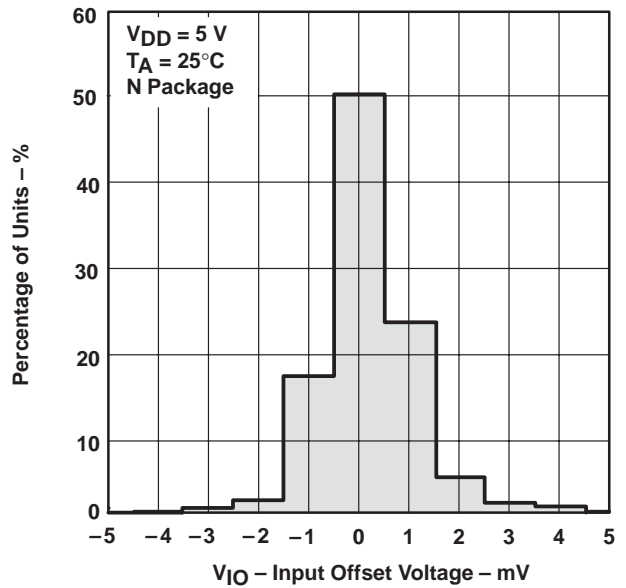

Figure 4

TYPICAL CHARACTERISTICS

DISTRIBUTION OF TLV2342
 INPUT OFFSET VOLTAGE
 TEMPERATURE COEFFICIENT

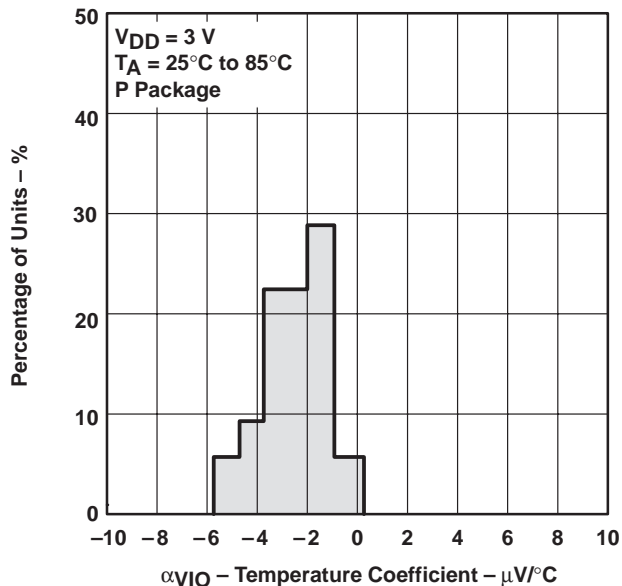

Figure 5

DISTRIBUTION OF TLV2342
 INPUT OFFSET VOLTAGE
 TEMPERATURE COEFFICIENT

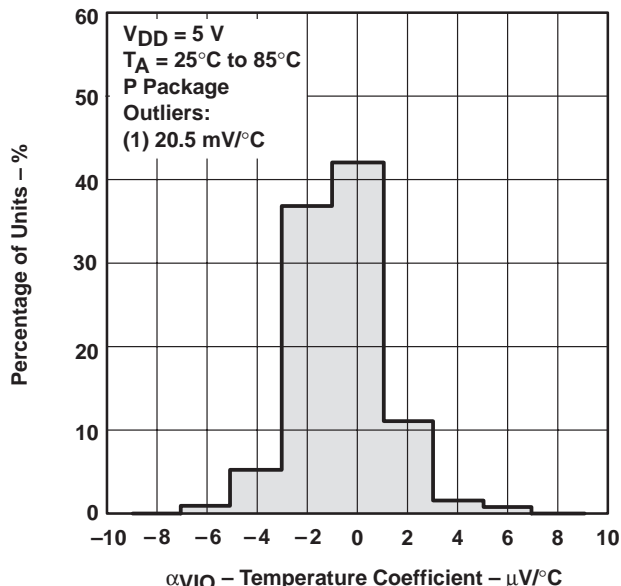

Figure 6

DISTRIBUTION OF TLV2344
 INPUT OFFSET VOLTAGE
 TEMPERATURE COEFFICIENT

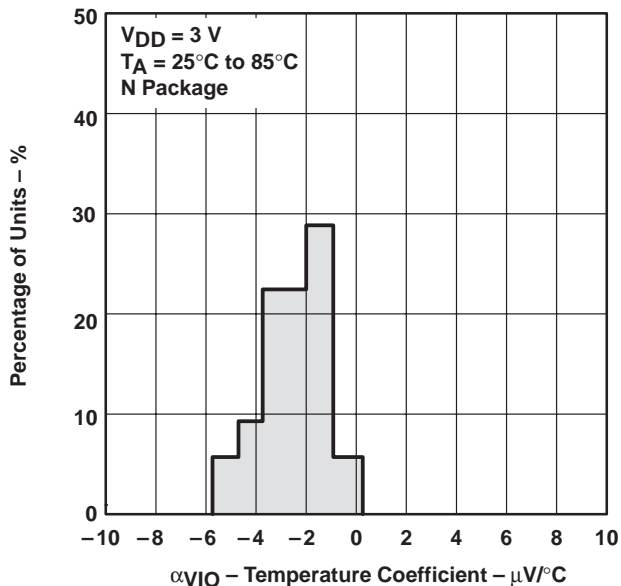

Figure 7

DISTRIBUTION OF TLV2344
 INPUT OFFSET VOLTAGE
 TEMPERATURE COEFFICIENT

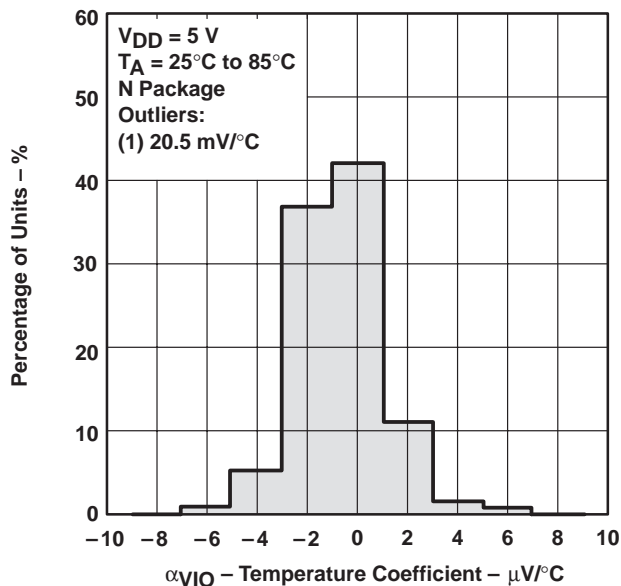
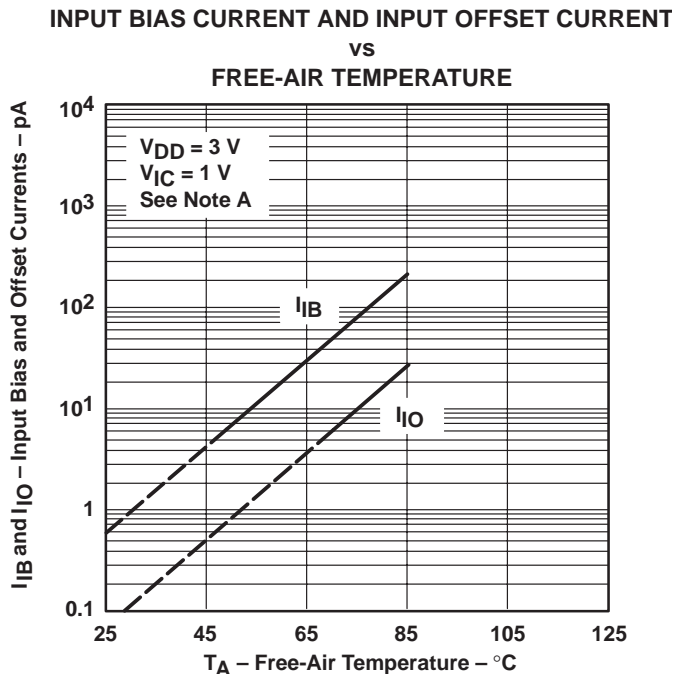

Figure 8

TYPICAL CHARACTERISTICS



NOTE: The typical values of input bias current and input offset current below 5 pA were determined mathematically.

Figure 9

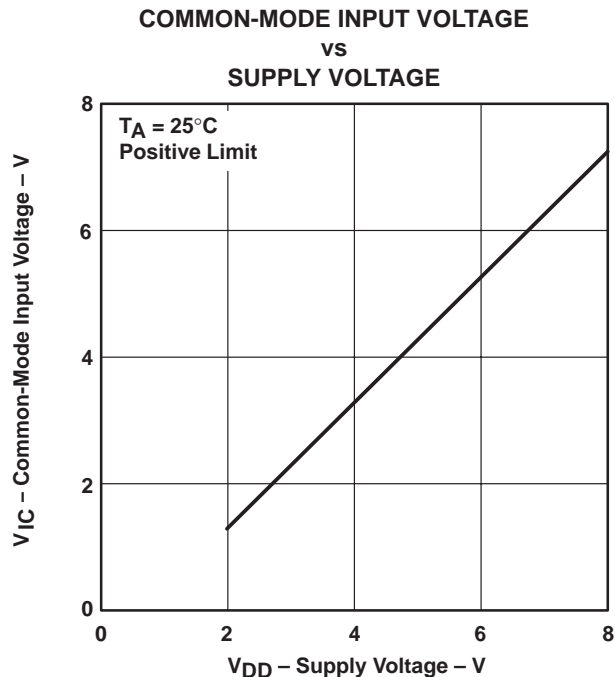

Figure 10

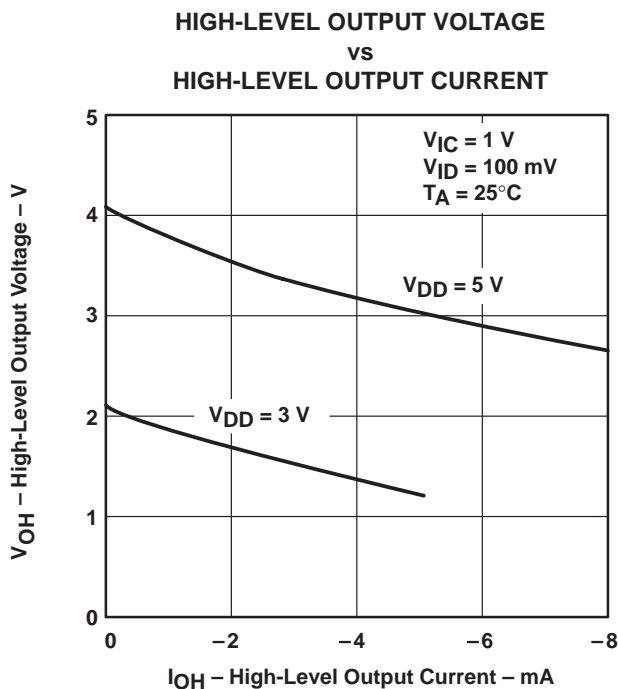

Figure 11

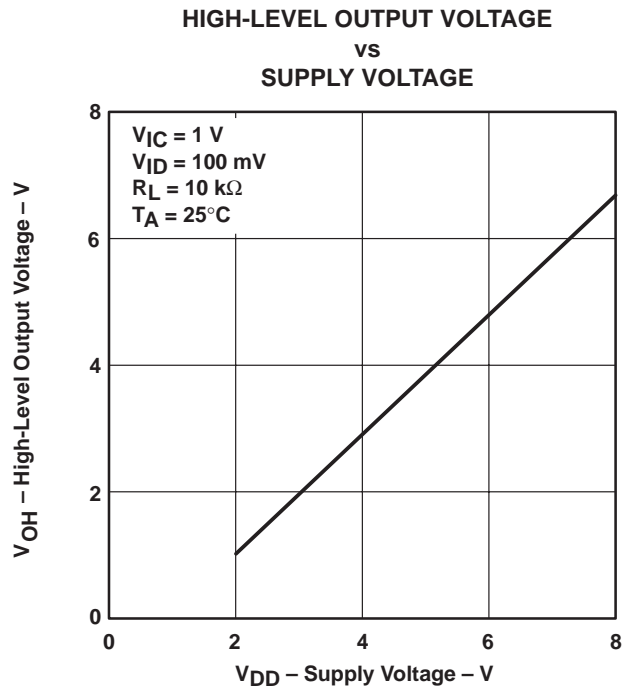

Figure 12

TYPICAL CHARACTERISTICS

**HIGH-LEVEL OUTPUT VOLTAGE
 vs
 FREE-AIR TEMPERATURE**

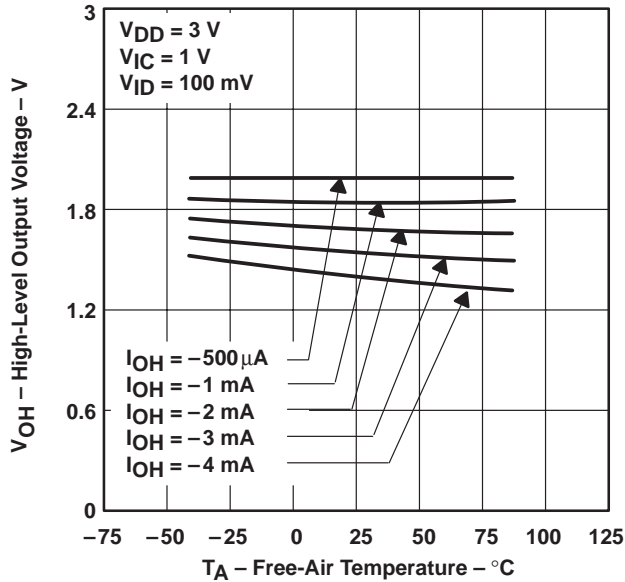

Figure 13

**LOW-LEVEL OUTPUT VOLTAGE
 vs
 COMMON-MODE INPUT VOLTAGE**

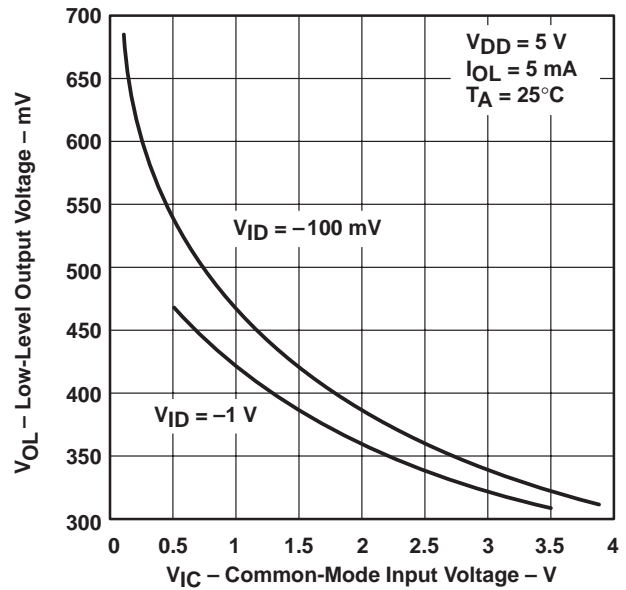

Figure 14

**LOW-LEVEL OUTPUT VOLTAGE
 vs
 FREE-AIR TEMPERATURE**

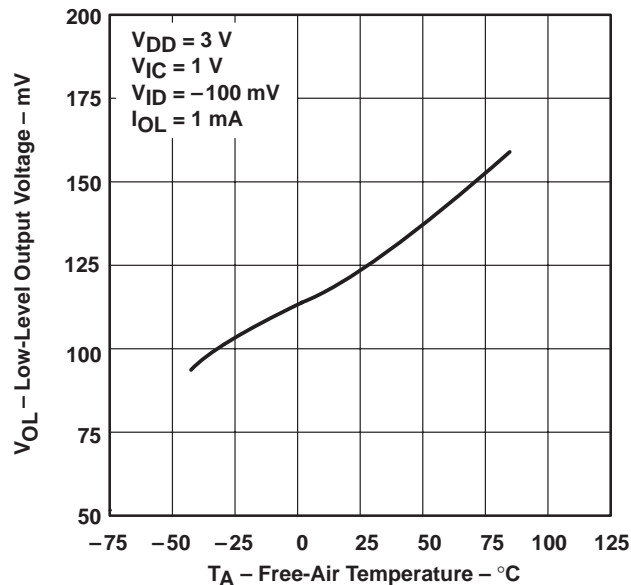

Figure 15

**LOW-LEVEL OUTPUT VOLTAGE
 vs
 FREE-AIR TEMPERATURE**

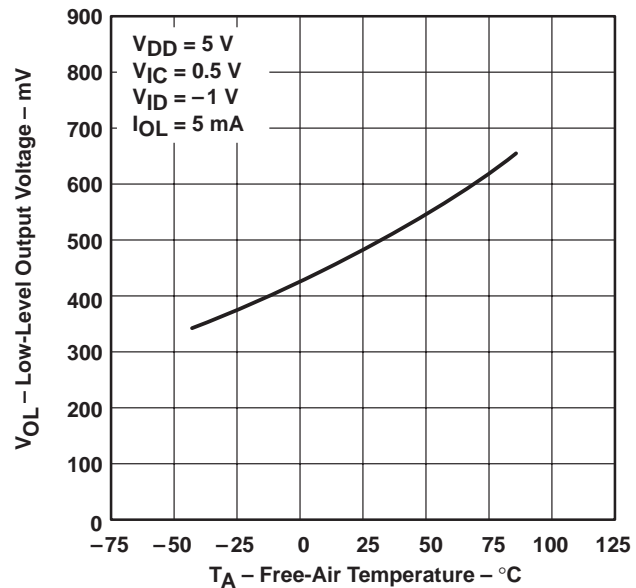
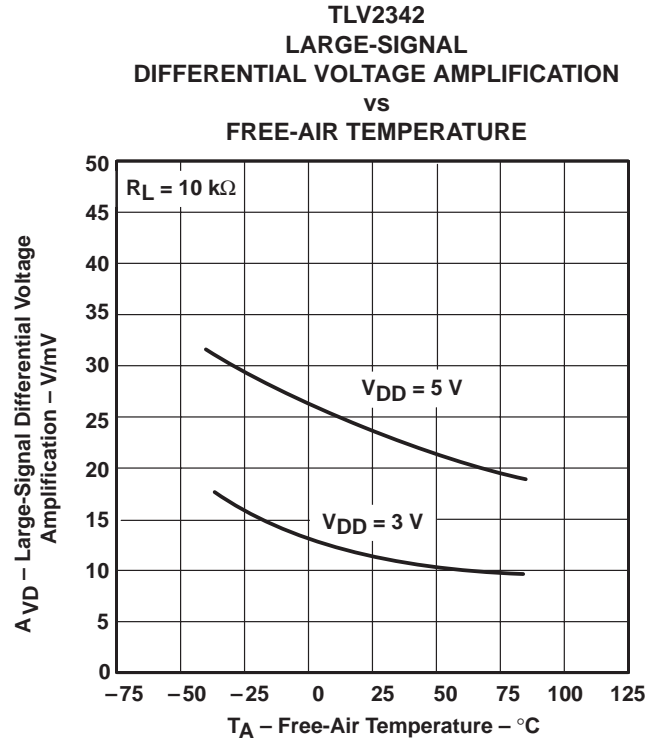
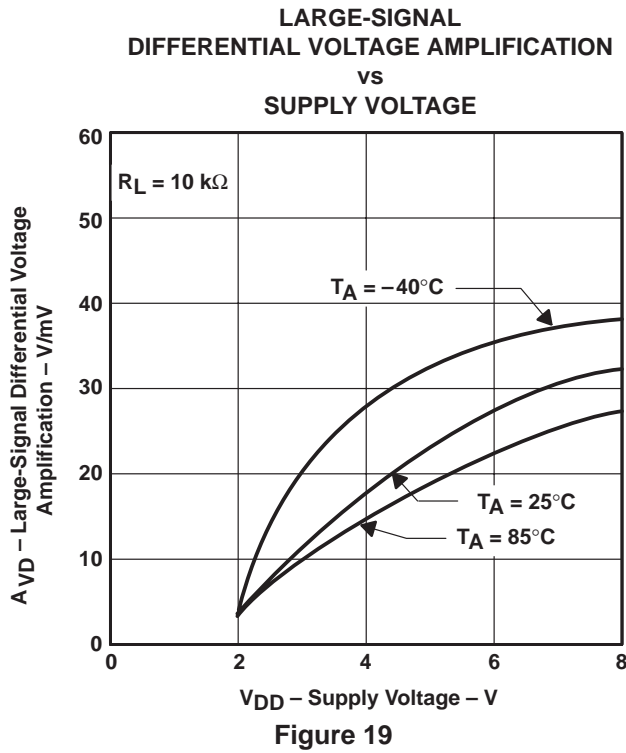
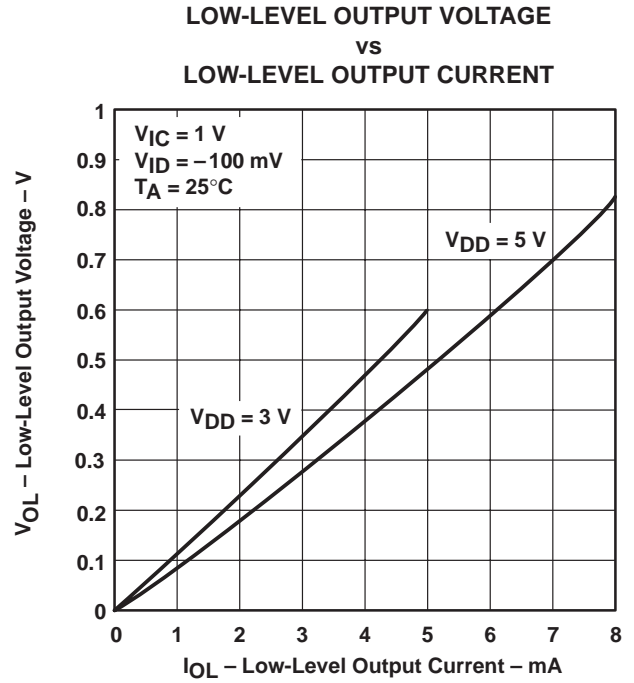
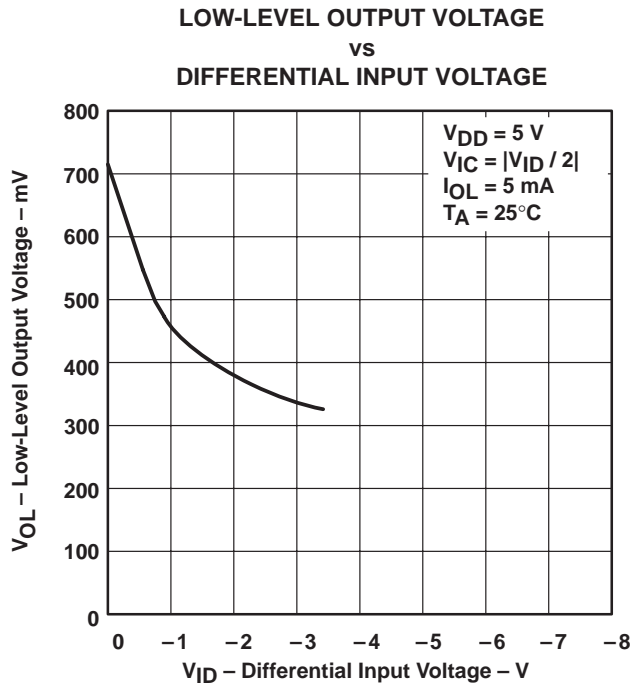

Figure 16

TYPICAL CHARACTERISTICS



TYPICAL CHARACTERISTICS

**TLV2344
 LARGE-SIGNAL
 DIFFERENTIAL VOLTAGE AMPLIFICATION
 vs
 FREE-AIR TEMPERATURE**

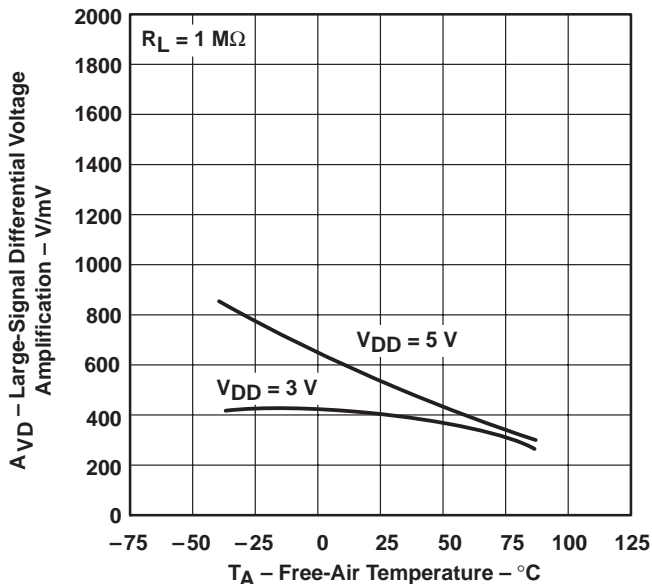

Figure 21

**LARGE-SIGNAL DIFFERENTIAL VOLTAGE
 AMPLIFICATION AND PHASE MARGIN
 vs
 FREQUENCY**

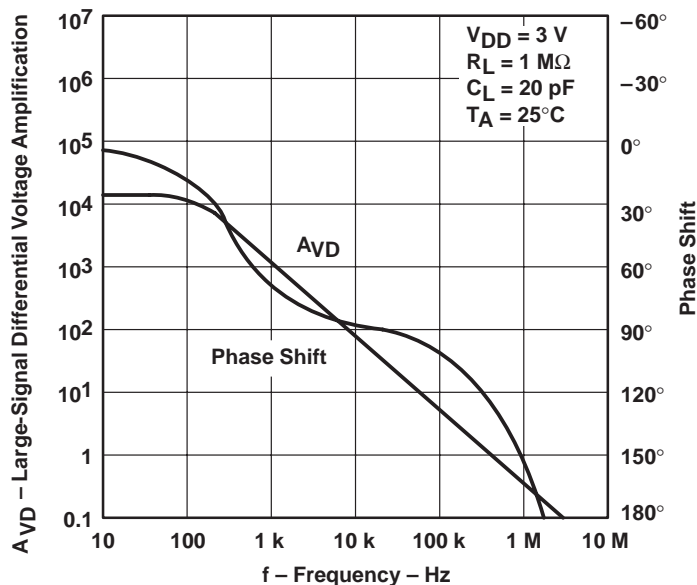

Figure 22

TYPICAL CHARACTERISTICS

LARGE-SIGNAL DIFFERENTIAL VOLTAGE
 AMPLIFICATION AND PHASE MARGIN
 vs
 FREQUENCY

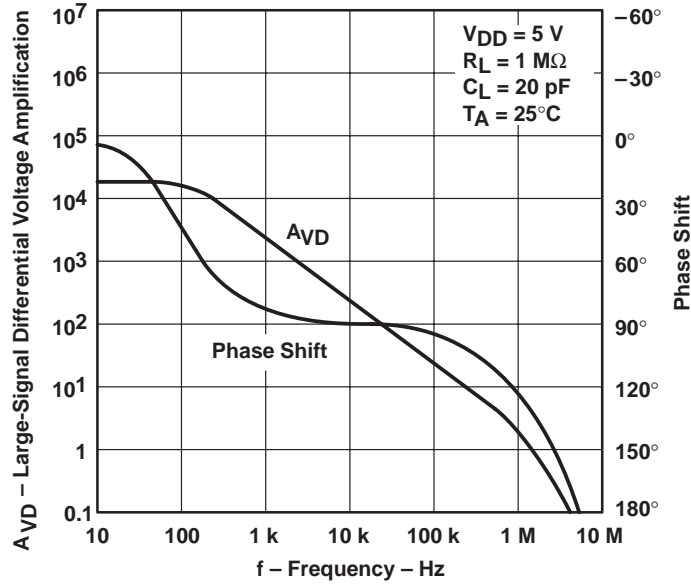

Figure 23

SUPPLY CURRENT
 vs
 SUPPLY VOLTAGE

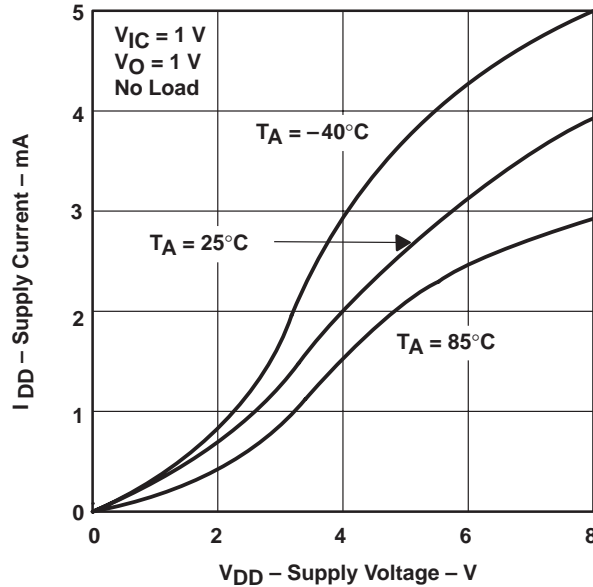
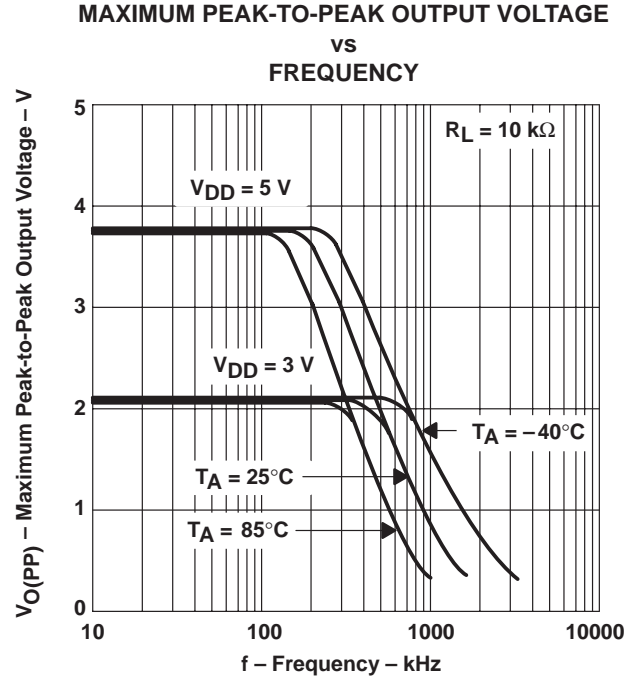
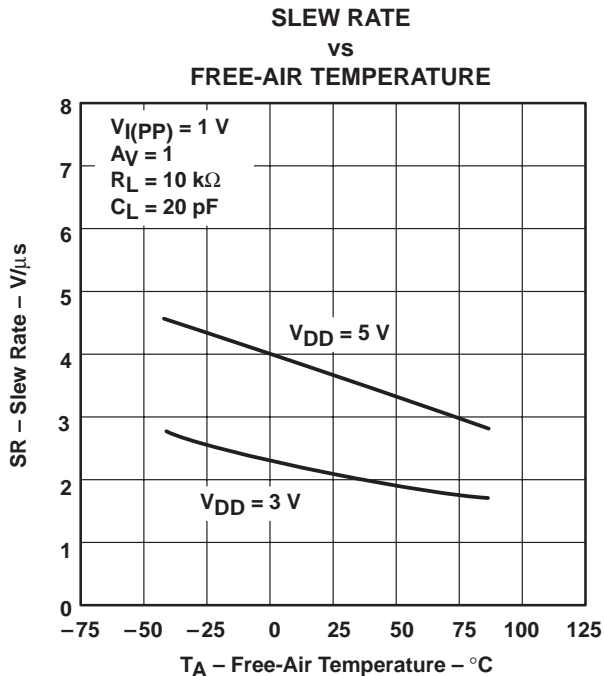
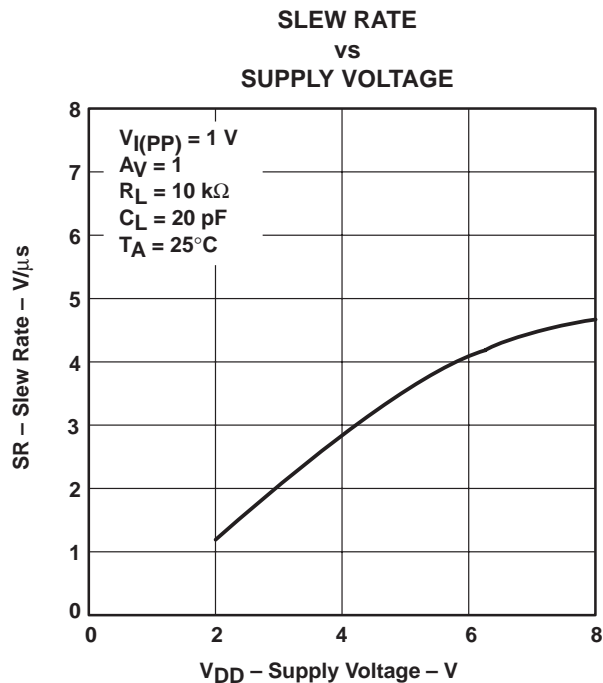
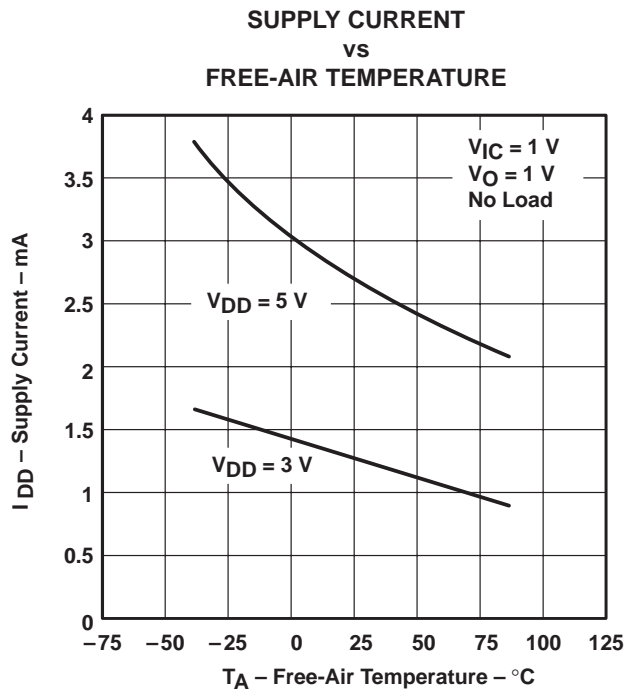

Figure 24

TYPICAL CHARACTERISTICS



TYPICAL CHARACTERISTICS

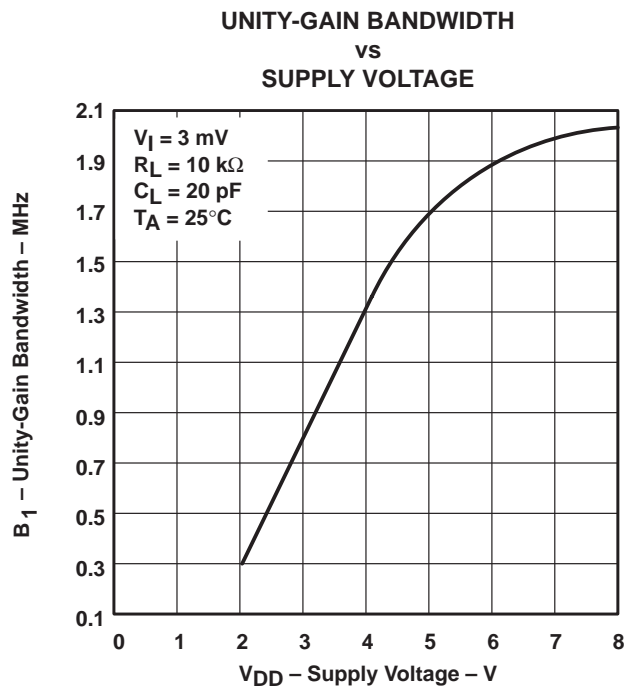

Figure 29

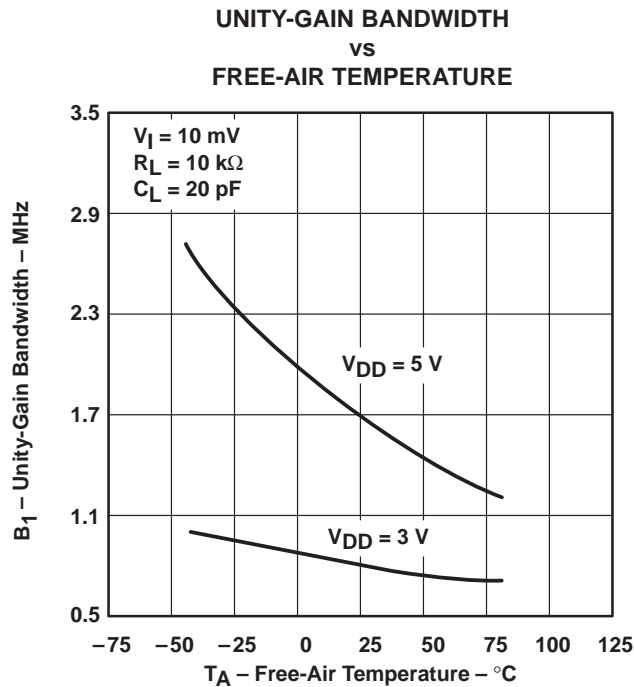

Figure 30

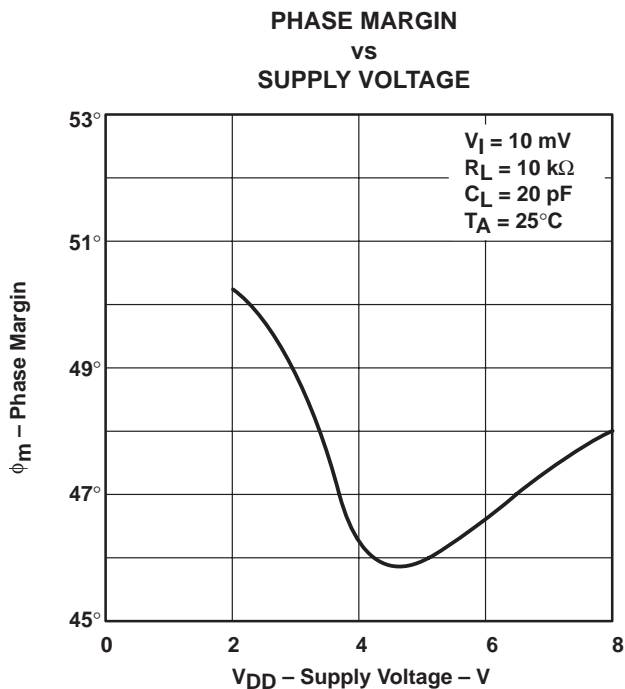

Figure 31

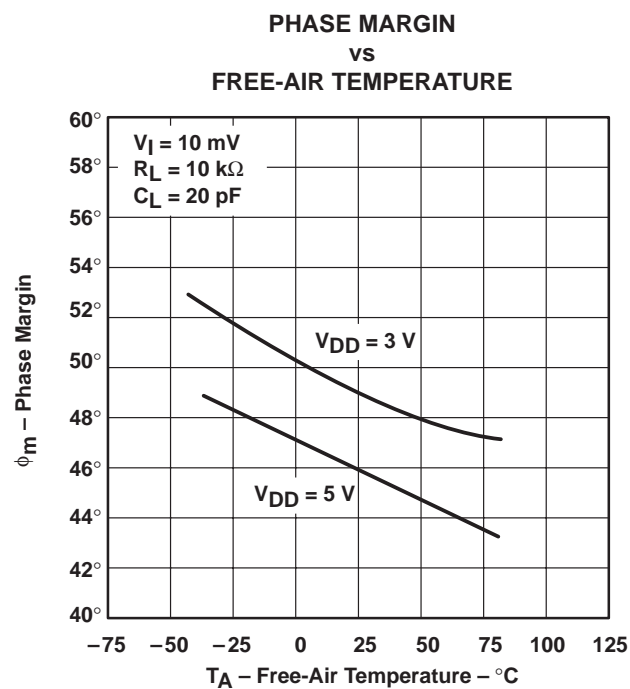

Figure 32

TYPICAL CHARACTERISTICS

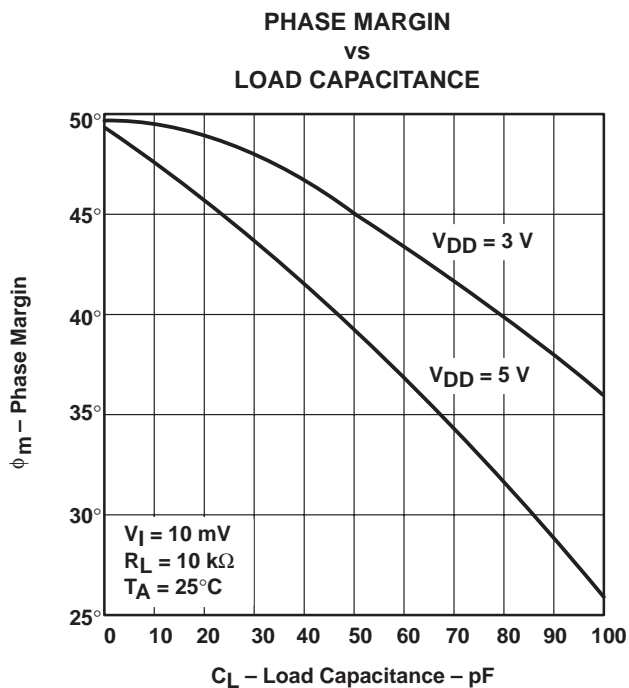

Figure 33

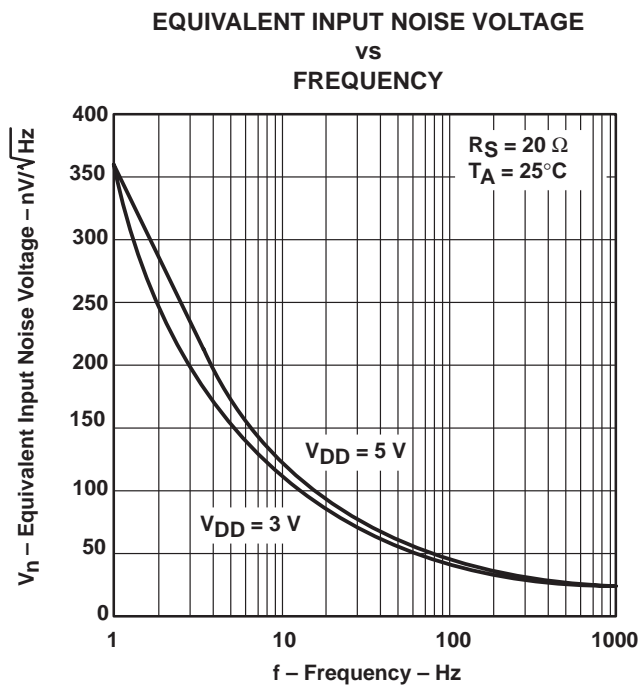

Figure 34

PARAMETER MEASUREMENT INFORMATION

single-supply versus split-supply test circuits

Because the TLV234x is optimized for single-supply operation, circuit configurations used for the various tests often present some inconvenience since the input signal, in many cases, must be offset from ground. This inconvenience can be avoided by testing the device with split supplies and the output load tied to the negative rail. A comparison of single-supply versus split-supply test circuits is shown below. The use of either circuit gives the same result.

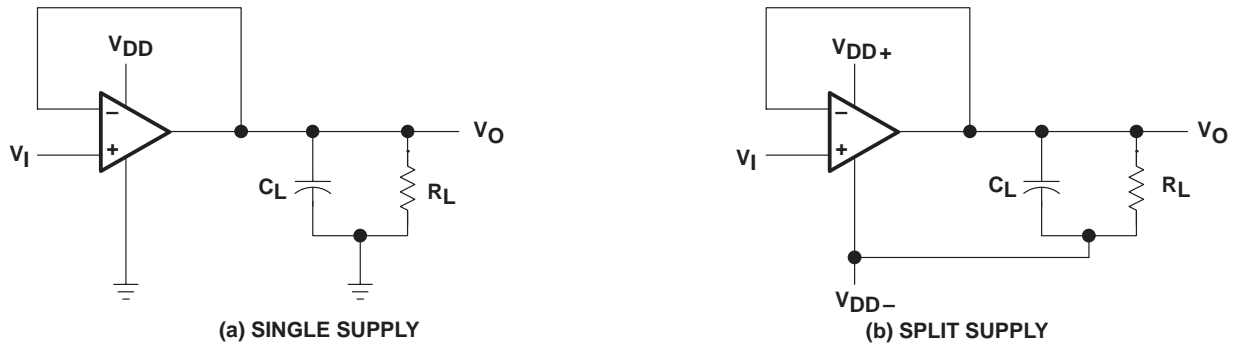

Figure 35. Unity-Gain Amplifier

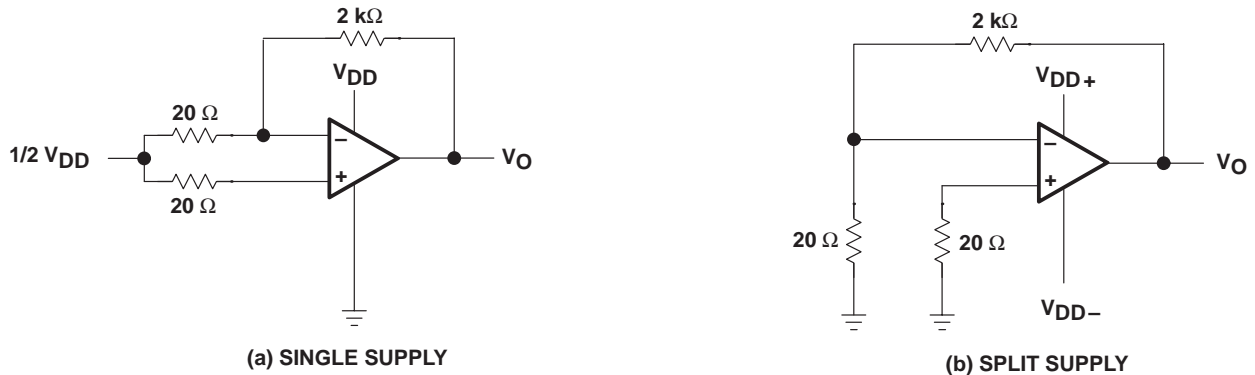

Figure 36. Noise-Test Circuit

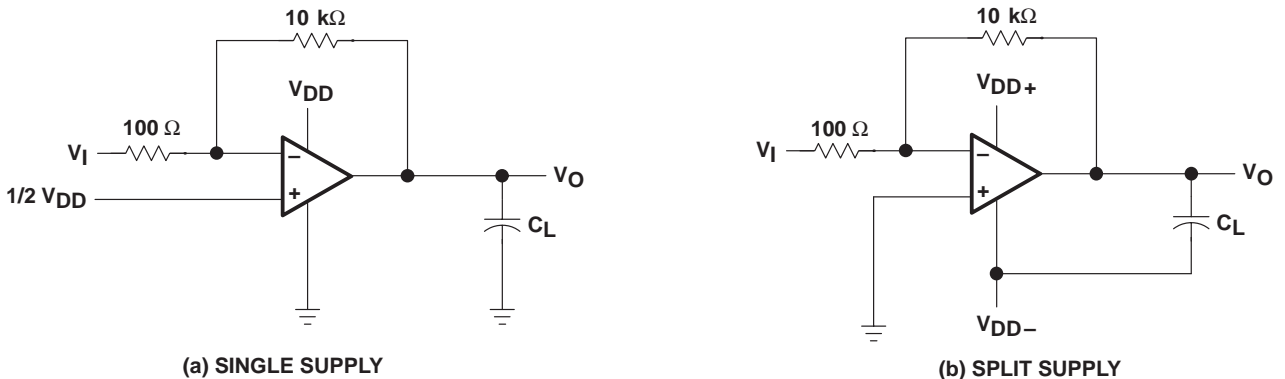

Figure 37. Gain-of-100 Inverting Amplifier

PARAMETER MEASUREMENT INFORMATION

input bias current

Because of the high input impedance of the TLV234x operational amplifier, attempts to measure the input bias current can result in erroneous readings. The bias current at normal ambient temperature is typically less than 1 pA, a value that is easily exceeded by leakages on the test socket. Two suggestions are offered to avoid erroneous measurements:

- Isolate the device from other potential leakage sources. Use a grounded shield around and between the device inputs (see Figure 38). Leakages that would otherwise flow to the inputs are shunted away.
- Compensate for the leakage of the test socket by actually performing an input bias current test (using a picoammeter) with no device in the test socket. The actual input bias current can then be calculated by subtracting the open-socket leakage readings from the readings obtained with a device in the test socket.

Many automatic testers as well as some bench-top operational amplifier testers use the servo-loop technique with a resistor in series with the device input to measure the input bias current (the voltage drop across the series resistor is measured and the bias current is calculated). This method requires that a device be inserted into a test socket to obtain a correct reading; therefore, an open-socket reading is not feasible using this method.

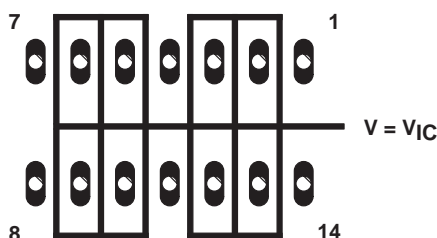

Figure 38. Isolation Metal Around Device Inputs
(N or P package)

low-level output voltage

To obtain low-level supply-voltage operation, some compromise is necessary in the input stage. This compromise results in the device low-level output voltage being dependent on both the common-mode input voltage level as well as the differential input voltage level. When attempting to correlate low-level output readings with those quoted in the electrical specifications, these two conditions should be observed. If conditions other than these are to be used, please refer to the Typical Characteristics section of this data sheet.

input offset voltage temperature coefficient

Erroneous readings often result from attempts to measure temperature coefficient of input offset voltage. This parameter is actually a calculation using input offset voltage measurements obtained at two different temperatures. When one (or both) of the temperatures is below freezing, moisture can collect on both the device and the test socket. This moisture results in leakage and contact resistance which can cause erroneous input offset voltage readings. The isolation techniques previously mentioned have no effect on the leakage since the moisture also covers the isolation metal itself, thereby rendering it useless. These measurements should be performed at temperatures above freezing to minimize error.

full-power response

Full-power response, the frequency above which the operational amplifier slew rate limits the output voltage swing, is often specified two ways: full-linear response and full-peak response. The full-linear response is

PARAMETER MEASUREMENT INFORMATION

generally measured by monitoring the distortion level of the output while increasing the frequency of a sinusoidal input signal until the maximum frequency is found above which the output contains significant distortion. The full-peak response is defined as the maximum output frequency, without regard to distortion, above which full peak-to-peak output swing cannot be maintained.

Because there is no industry-wide accepted value for significant distortion, the full-peak response is specified in this data sheet and is measured using the circuit of Figure 35. The initial setup involves the use of a sinusoidal input to determine the maximum peak-to-peak output of the device (the amplitude of the sinusoidal wave is increased until clipping occurs). The sinusoidal wave is then replaced with a square wave of the same amplitude. The frequency is then increased until the maximum peak-to-peak output can no longer be maintained (Figure 39). A square wave is used to allow a more accurate determination of the point at which the maximum peak-to-peak output is reached.

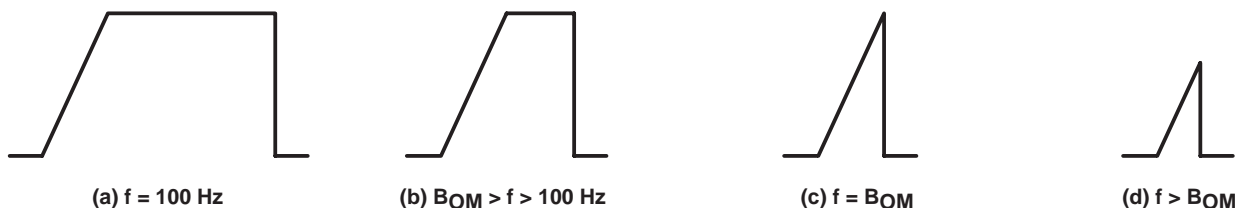

Figure 39. Full-Power-Response Output Signal

test time

Inadequate test time is a frequent problem, especially when testing CMOS devices in a high-volume, short-test-time environment. Internal capacitances are inherently higher in CMOS than in bipolar and BiFET devices, and require longer test times than their bipolar and BiFET counterparts. The problem becomes more pronounced with reduced supply levels and lower temperatures.

APPLICATION INFORMATION

single-supply operation

While the TLV234x performs well using dual-power supplies (also called balanced or split supplies), the design is optimized for single-supply operation. This includes an input common-mode voltage range that encompasses ground as well as an output voltage range that pulls down to ground. The supply voltage range extends down to 2 V, thus allowing operation with supply levels commonly available for TTL and HCMOS.

Many single-supply applications require that a voltage be applied to one input to establish a reference level that is above ground. This virtual ground can be generated using two large resistors, but a preferred technique is to use a virtual-ground generator such as the TLE2426 (see Figure 40).

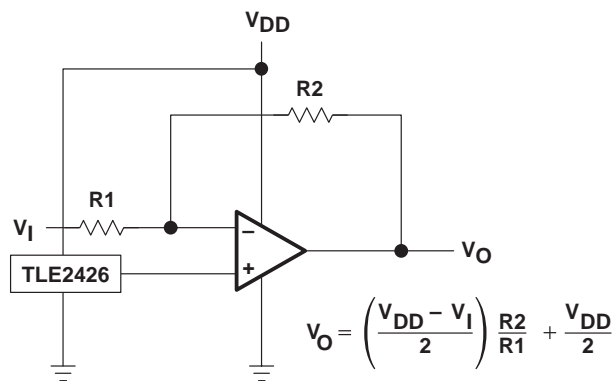

Figure 40. Inverting Amplifier With Voltage Reference

APPLICATION INFORMATION

single-supply operation (continued)

The TLE2426 supplies an accurate voltage equal to $V_{DD}/2$ while consuming very little power and is suitable for supply voltages of greater than 4 V.

The TLV234x works well in conjunction with digital logic; however, when powering both linear devices and digital logic from the same power supply, the following precautions are recommended:

- Power the linear devices from separate bypassed supply lines (see Figure 41); otherwise, the linear device supply rails can fluctuate due to voltage drops caused by high switching currents in the digital logic.
- Use proper bypass techniques to reduce the probability of noise-induced errors. Single capacitive decoupling is often adequate; however, RC decoupling may be necessary in high-frequency applications.

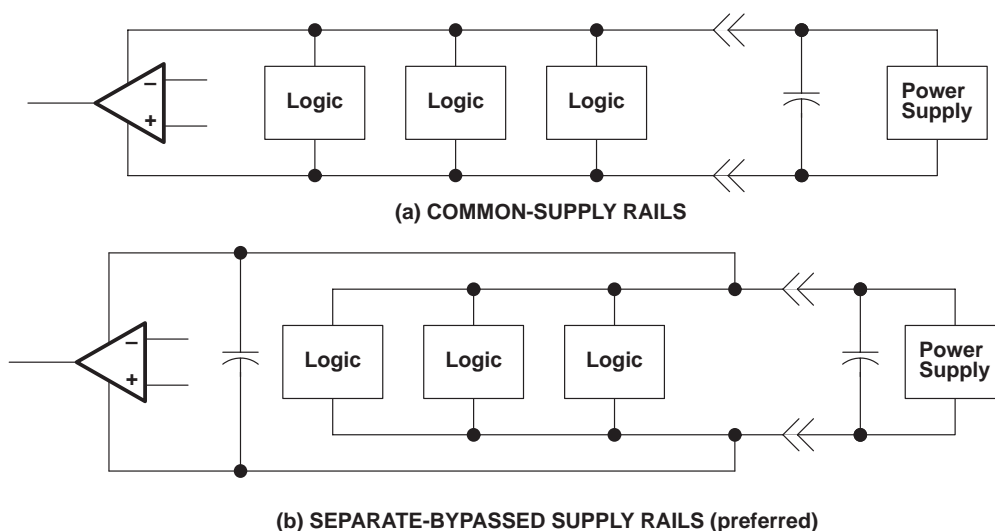

Figure 41. Common Versus Separate Supply Rails

input characteristics

The TLV234x is specified with a minimum and a maximum input voltage that, if exceeded at either input, could cause the device to malfunction. Exceeding this specified range is a common problem, especially in single-supply operation. The lower range limit includes the negative rail, while the upper range limit is specified at $V_{DD} - 1$ V at $T_A = 25^\circ\text{C}$ and at $V_{DD} - 1.2$ V at all other temperatures.

The use of the polysilicon-gate process and the careful input circuit design gives the TLV234x very good input offset voltage drift characteristics relative to conventional metal-gate processes. Offset voltage drift in CMOS devices is highly influenced by threshold voltage shifts caused by polarization of the phosphorus dopant implanted in the oxide. Placing the phosphorus dopant in a conductor (such as a polysilicon gate) alleviates the polarization problem, thus reducing threshold voltage shifts by more than an order of magnitude. The offset voltage drift with time has been calculated to be typically $0.1 \mu\text{V}/\text{month}$, including the first month of operation.

Because of the extremely high input impedance and resulting low bias-current requirements, the TLV234x is well suited for low-level signal processing; however, leakage currents on printed-circuit boards and sockets can easily exceed bias-current requirements and cause a degradation in device performance.

APPLICATION INFORMATION

input characteristics (continued)

It is good practice to include guard rings around inputs (similar to those of Figure 38 in the Parameter Measurement Information section). These guards should be driven from a low-impedance source at the same voltage level as the common-mode input (see Figure 42).

The inputs of any unused amplifiers should be tied to ground to avoid possible oscillation.

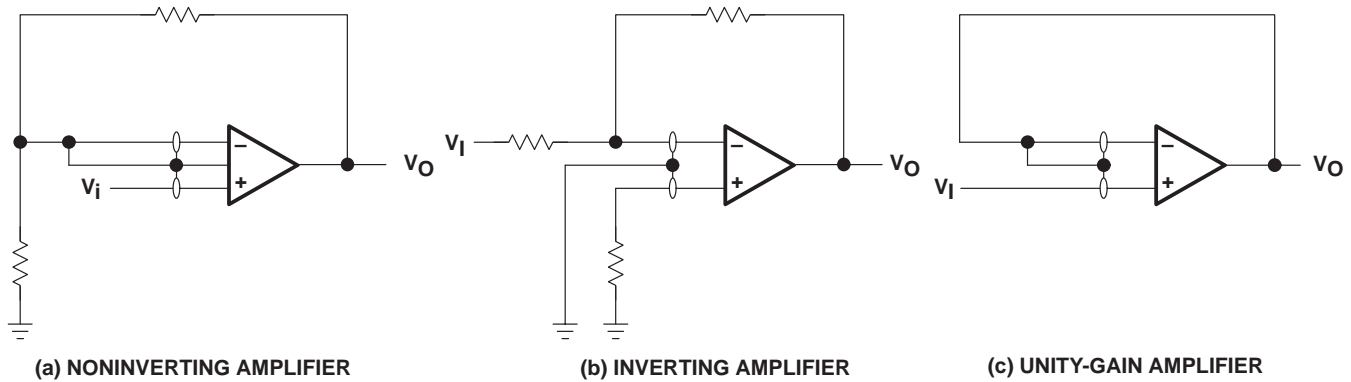

Figure 42. Guard-Ring Schemes

noise performance

The noise specifications in operational amplifier circuits are greatly dependent on the current in the first-stage differential amplifier. The low input bias-current requirements of the TLV234x results in a very low noise current, which is insignificant in most applications. This feature makes the device especially favorable over bipolar devices when using values of circuit impedance greater than 50 k Ω , since bipolar devices exhibit greater noise currents.

feedback

Operational amplifiers circuits nearly always employ feedback, and since feedback is the first prerequisite for oscillation, a little caution is appropriate. Most oscillation problems result from driving capacitive loads and ignoring stray input capacitance. A small-value capacitor connected in parallel with the feedback resistor is an effective remedy (see Figure 43). The value of this capacitor is optimized empirically.

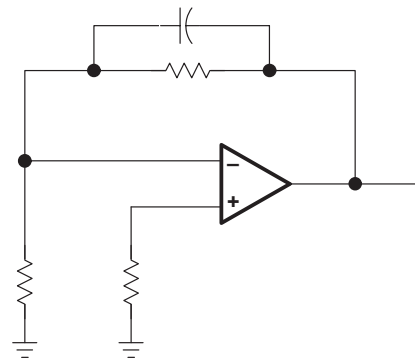

Figure 43. Compensation for Input Capacitance

electrostatic-discharge protection

The TLV234x incorporates an internal electrostatic-discharge (ESD)-protection circuit that prevents functional failures at voltages up to 2000 V as tested under MIL-PRF-38535, Method 3015.2. Care should be exercised, however, when handling these devices as exposure to ESD may result in the degradation of the device parametric performance. The protection circuit also causes the input bias currents to be temperature dependent and have the characteristics of a reverse-biased diode.

APPLICATION INFORMATION

latch-up

Because CMOS devices are susceptible to latch-up due to their inherent parasitic thyristors, the TLV234x inputs and outputs are designed to withstand –100-mA surge currents without sustaining latch-up; however, techniques should be used to reduce the chance of latch-up whenever possible. Internal protection diodes should not by design be forward biased. Applied input and output voltage should not exceed the supply voltage by more than 300 mV. Care should be exercised when using capacitive coupling on pulse generators. Supply transients should be shunted by the use of decoupling capacitors (0.1 μF typical) located across the supply rails as close to the device as possible.

The current path established if latch-up occurs is usually between the positive supply rail and ground and can be triggered by surges on the supply lines and/or voltages on either the output or inputs that exceed the supply voltage. Once latch-up occurs, the current flow is limited only by the impedance of the power supply and the forward resistance of the parasitic thyristor and usually results in the destruction of the device. The chance of latch-up occurring increases with increasing temperature and supply voltages.

output characteristics

The output stage of the TLV234x is designed to sink and source relatively high amounts of current (see Typical Characteristics). If the output is subjected to a short-circuit condition, this high-current capability can cause device damage under certain conditions. Output current capability increases with supply voltage.

Although the TLV234x possesses excellent high-level output voltage and current capability, methods are available for boosting this capability if needed. The simplest method involves the use of a pullup resistor (R_P) connected from the output to the positive supply rail (see Figure 44). There are two disadvantages to the use of this circuit. First, the NMOS pulldown transistor N4 (see equivalent schematic) must sink a comparatively large amount of current. In this circuit, N4 behaves like a linear resistor with an on resistance between approximately 60 Ω and 180 Ω, depending on how hard the operational amplifier input is driven. With very low values of R_P , a voltage offset from 0 V at the output occurs. Secondly, pullup resistor R_P acts as a drain load to N4 and the gain of the operational amplifier is reduced at output voltage levels where N5 is not supplying the output current.

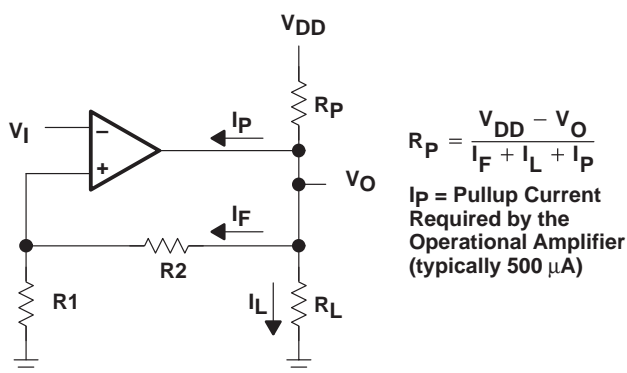

Figure 44. Resistive Pullup to Increase V_{OH}

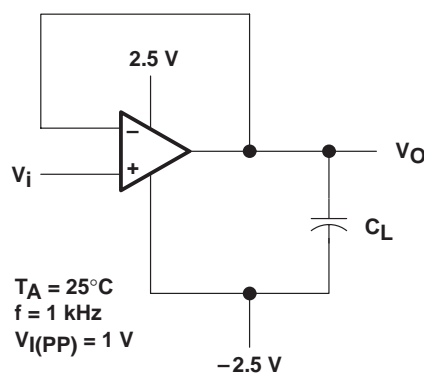
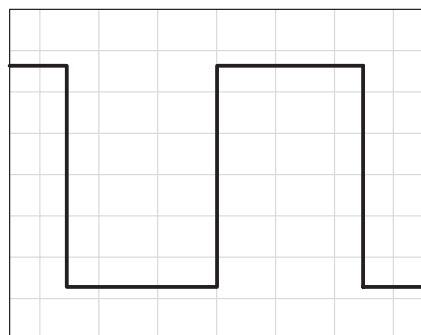

Figure 45. Test Circuit for Output Characteristics

All operating characteristics of the TLV234x are measured using a 20-pF load. The device drives higher capacitive loads; however, as output load capacitance increases, the resulting response pole occurs at lower frequencies thereby causing ringing, peaking, or even oscillation (see Figure 45 and Figure 46). In many cases, adding some compensation in the form of a series resistor in the feedback loop alleviates the problem.

TYPICAL APPLICATION DATA

output characteristics (continued)



(a) $C_L = 20 \text{ pF}$, $R_L = \text{NO LOAD}$



(b) $C_L = 130 \text{ pF}$, $R_L = \text{NO LOAD}$

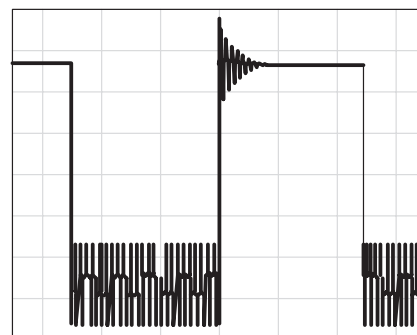

(c) $C_L = 150 \text{ pF}$, $R_L = \text{NO LOAD}$

Figure 46. Effect of Capacitive Loads

PACKAGING INFORMATION

Orderable Device	Status (1)	Package Type	Package Drawing	Pins	Package Qty	Eco Plan (2)	Lead/Ball Finish (6)	MSL Peak Temp (3)	Op Temp (°C)	Device Marking (4/5)	Samples
TLV2342ID	ACTIVE	SOIC	D	8	75	Green (RoHS & no Sb/Br)	CU NIPDAU	Level-1-260C-UNLIM	-40 to 85	2342I	Samples
TLV2342IDR	ACTIVE	SOIC	D	8	2500	Green (RoHS & no Sb/Br)	CU NIPDAU	Level-1-260C-UNLIM	-40 to 85	2342I	Samples
TLV2342IDRG4	ACTIVE	SOIC	D	8	2500	Green (RoHS & no Sb/Br)	CU NIPDAU	Level-1-260C-UNLIM	-40 to 85	2342I	Samples
TLV2342IP	ACTIVE	PDIP	P	8	50	Pb-Free (RoHS)	CU NIPDAU	N / A for Pkg Type	-40 to 85	TLV2342IP	Samples
TLV2342IPW	ACTIVE	TSSOP	PW	8	150	Green (RoHS & no Sb/Br)	CU NIPDAU	Level-1-260C-UNLIM	-40 to 85	TY2342	Samples
TLV2342IPWG4	ACTIVE	TSSOP	PW	8	150	Green (RoHS & no Sb/Br)	CU NIPDAU	Level-1-260C-UNLIM	-40 to 85	TY2342	Samples
TLV2342IPWLE	OBSOLETE	TSSOP	PW	8		TBD	Call TI	Call TI			
TLV2344IDR	OBSOLETE	SOIC	D	14		TBD	Call TI	Call TI			
TLV2344IN	ACTIVE	PDIP	N	14	25	Pb-Free (RoHS)	CU NIPDAU	N / A for Pkg Type	-40 to 85	TLV2344IN	Samples
TLV2344IPWLE	OBSOLETE	TSSOP	PW	14		TBD	Call TI	Call TI			

(1) The marketing status values are defined as follows:

ACTIVE: Product device recommended for new designs.

LIFEBUY: TI has announced that the device will be discontinued, and a lifetime-buy period is in effect.

NRND: Not recommended for new designs. Device is in production to support existing customers, but TI does not recommend using this part in a new design.

PREVIEW: Device has been announced but is not in production. Samples may or may not be available.

OBSOLETE: TI has discontinued the production of the device.

(2) Eco Plan - The planned eco-friendly classification: Pb-Free (RoHS), Pb-Free (RoHS Exempt), or Green (RoHS & no Sb/Br) - please check <http://www.ti.com/productcontent> for the latest availability information and additional product content details.

TBD: The Pb-Free/Green conversion plan has not been defined.

Pb-Free (RoHS): TI's terms "Lead-Free" or "Pb-Free" mean semiconductor products that are compatible with the current RoHS requirements for all 6 substances, including the requirement that lead not exceed 0.1% by weight in homogeneous materials. Where designed to be soldered at high temperatures, TI Pb-Free products are suitable for use in specified lead-free processes.

Pb-Free (RoHS Exempt): This component has a RoHS exemption for either 1) lead-based flip-chip solder bumps used between the die and package, or 2) lead-based die adhesive used between the die and leadframe. The component is otherwise considered Pb-Free (RoHS compatible) as defined above.

Green (RoHS & no Sb/Br): TI defines "Green" to mean Pb-Free (RoHS compatible), and free of Bromine (Br) and Antimony (Sb) based flame retardants (Br or Sb do not exceed 0.1% by weight in homogeneous material)

(3) MSL, Peak Temp. - The Moisture Sensitivity Level rating according to the JEDEC industry standard classifications, and peak solder temperature.

(4) There may be additional marking, which relates to the logo, the lot trace code information, or the environmental category on the device.

(5) Multiple Device Markings will be inside parentheses. Only one Device Marking contained in parentheses and separated by a "~" will appear on a device. If a line is indented then it is a continuation of the previous line and the two combined represent the entire Device Marking for that device.

(6) Lead/Ball Finish - Orderable Devices may have multiple material finish options. Finish options are separated by a vertical ruled line. Lead/Ball Finish values may wrap to two lines if the finish value exceeds the maximum column width.

Important Information and Disclaimer:The information provided on this page represents TI's knowledge and belief as of the date that it is provided. TI bases its knowledge and belief on information provided by third parties, and makes no representation or warranty as to the accuracy of such information. Efforts are underway to better integrate information from third parties. TI has taken and continues to take reasonable steps to provide representative and accurate information but may not have conducted destructive testing or chemical analysis on incoming materials and chemicals. TI and TI suppliers consider certain information to be proprietary, and thus CAS numbers and other limited information may not be available for release.

In no event shall TI's liability arising out of such information exceed the total purchase price of the TI part(s) at issue in this document sold by TI to Customer on an annual basis.

TAPE AND REEL INFORMATION



QUADRANT ASSIGNMENTS FOR PIN 1 ORIENTATION IN TAPE



*All dimensions are nominal

Device	Package Type	Package Drawing	Pins	SPQ	Reel Diameter (mm)	Reel Width W1 (mm)	A0 (mm)	B0 (mm)	K0 (mm)	P1 (mm)	W (mm)	Pin1 Quadrant
TLV2342IDR	SOIC	D	8	2500	330.0	12.4	6.4	5.2	2.1	8.0	12.0	Q1

TAPE AND REEL BOX DIMENSIONS



*All dimensions are nominal

Device	Package Type	Package Drawing	Pins	SPQ	Length (mm)	Width (mm)	Height (mm)
TLV2342IDR	SOIC	D	8	2500	340.5	338.1	20.6

P (R-PDIP-T8)

PLASTIC DUAL-IN-LINE PACKAGE



- NOTES:
- A. All linear dimensions are in inches (millimeters).
 - B. This drawing is subject to change without notice.
 - C. Falls within JEDEC MS-001 variation BA.

N (R-PDIP-T**)

PLASTIC DUAL-IN-LINE PACKAGE

16 PINS SHOWN



- NOTES:
- A. All linear dimensions are in inches (millimeters).
 - B. This drawing is subject to change without notice.
 - Falls within JEDEC MS-001, except 18 and 20 pin minimum body length (Dim A).
 - The 20 pin end lead shoulder width is a vendor option, either half or full width.

D (R-PDSO-G14)

PLASTIC SMALL OUTLINE



- NOTES:
- A. All linear dimensions are in inches (millimeters).
 - B. This drawing is subject to change without notice.
 - Body length does not include mold flash, protrusions, or gate burrs. Mold flash, protrusions, or gate burrs shall not exceed 0.006 (0,15) each side.
 - Body width does not include interlead flash. Interlead flash shall not exceed 0.017 (0,43) each side.
 - E. Reference JEDEC MS-012 variation AB.

PW (R-PDSO-G14)

PLASTIC SMALL OUTLINE



- NOTES:
- A. All linear dimensions are in millimeters. Dimensioning and tolerancing per ASME Y14.5M-1994.
 - B. This drawing is subject to change without notice.
 - C. Body length does not include mold flash, protrusions, or gate burrs. Mold flash, protrusions, or gate burrs shall not exceed 0,15 each side.
 - D. Body width does not include interlead flash. Interlead flash shall not exceed 0,25 each side.
 - E. Falls within JEDEC MO-153

PW0008A



PACKAGE OUTLINE
TSSOP - 1.2 mm max height

SMALL OUTLINE PACKAGE



4221848/A 02/2015

NOTES:

1. All linear dimensions are in millimeters. Any dimensions in parenthesis are for reference only. Dimensioning and tolerancing per ASME Y14.5M.
2. This drawing is subject to change without notice.
3. This dimension does not include mold flash, protrusions, or gate burrs. Mold flash, protrusions, or gate burrs shall not exceed 0.15 mm per side.
4. This dimension does not include interlead flash. Interlead flash shall not exceed 0.25 mm per side.
5. Reference JEDEC registration MO-153, variation AA.

EXAMPLE BOARD LAYOUT

PW0008A

TSSOP - 1.2 mm max height

SMALL OUTLINE PACKAGE



LAND PATTERN EXAMPLE
SCALE:10X



SOLDER MASK DETAILS
NOT TO SCALE

4221848/A 02/2015

NOTES: (continued)

- 6. Publication IPC-7351 may have alternate designs.
- 7. Solder mask tolerances between and around signal pads can vary based on board fabrication site.

EXAMPLE STENCIL DESIGN

PW0008A

TSSOP - 1.2 mm max height

SMALL OUTLINE PACKAGE



SOLDER PASTE EXAMPLE
BASED ON 0.125 mm THICK STENCIL
SCALE:10X

4221848/A 02/2015

NOTES: (continued)

8. Laser cutting apertures with trapezoidal walls and rounded corners may offer better paste release. IPC-7525 may have alternate design recommendations.
9. Board assembly site may have different recommendations for stencil design.

D (R-PDSO-G8)

PLASTIC SMALL OUTLINE



- NOTES:
- A. All linear dimensions are in inches (millimeters).
 - B. This drawing is subject to change without notice.
 - Body length does not include mold flash, protrusions, or gate burrs. Mold flash, protrusions, or gate burrs shall not exceed 0.006 (0,15) each side.
 - Body width does not include interlead flash. Interlead flash shall not exceed 0.017 (0,43) each side.
 - E. Reference JEDEC MS-012 variation AA.

D (R-PDSO-G8)

PLASTIC SMALL OUTLINE



4211283-2/E 08/12

- NOTES:
- A. All linear dimensions are in millimeters.
 - B. This drawing is subject to change without notice.
 - C. Publication IPC-7351 is recommended for alternate designs.
 - D. Laser cutting apertures with trapezoidal walls and also rounding corners will offer better paste release. Customers should contact their board assembly site for stencil design recommendations. Refer to IPC-7525 for other stencil recommendations.
 - E. Customers should contact their board fabrication site for solder mask tolerances between and around signal pads.

IMPORTANT NOTICE

Texas Instruments Incorporated and its subsidiaries (TI) reserve the right to make corrections, enhancements, improvements and other changes to its semiconductor products and services per JESD46, latest issue, and to discontinue any product or service per JESD48, latest issue. Buyers should obtain the latest relevant information before placing orders and should verify that such information is current and complete. All semiconductor products (also referred to herein as "components") are sold subject to TI's terms and conditions of sale supplied at the time of order acknowledgment.

TI warrants performance of its components to the specifications applicable at the time of sale, in accordance with the warranty in TI's terms and conditions of sale of semiconductor products. Testing and other quality control techniques are used to the extent TI deems necessary to support this warranty. Except where mandated by applicable law, testing of all parameters of each component is not necessarily performed.

TI assumes no liability for applications assistance or the design of Buyers' products. Buyers are responsible for their products and applications using TI components. To minimize the risks associated with Buyers' products and applications, Buyers should provide adequate design and operating safeguards.

TI does not warrant or represent that any license, either express or implied, is granted under any patent right, copyright, mask work right, or other intellectual property right relating to any combination, machine, or process in which TI components or services are used. Information published by TI regarding third-party products or services does not constitute a license to use such products or services or a warranty or endorsement thereof. Use of such information may require a license from a third party under the patents or other intellectual property of the third party, or a license from TI under the patents or other intellectual property of TI.

Reproduction of significant portions of TI information in TI data books or data sheets is permissible only if reproduction is without alteration and is accompanied by all associated warranties, conditions, limitations, and notices. TI is not responsible or liable for such altered documentation. Information of third parties may be subject to additional restrictions.

Resale of TI components or services with statements different from or beyond the parameters stated by TI for that component or service voids all express and any implied warranties for the associated TI component or service and is an unfair and deceptive business practice. TI is not responsible or liable for any such statements.

Buyer acknowledges and agrees that it is solely responsible for compliance with all legal, regulatory and safety-related requirements concerning its products, and any use of TI components in its applications, notwithstanding any applications-related information or support that may be provided by TI. Buyer represents and agrees that it has all the necessary expertise to create and implement safeguards which anticipate dangerous consequences of failures, monitor failures and their consequences, lessen the likelihood of failures that might cause harm and take appropriate remedial actions. Buyer will fully indemnify TI and its representatives against any damages arising out of the use of any TI components in safety-critical applications.

In some cases, TI components may be promoted specifically to facilitate safety-related applications. With such components, TI's goal is to help enable customers to design and create their own end-product solutions that meet applicable functional safety standards and requirements. Nonetheless, such components are subject to these terms.

No TI components are authorized for use in FDA Class III (or similar life-critical medical equipment) unless authorized officers of the parties have executed a special agreement specifically governing such use.

Only those TI components which TI has specifically designated as military grade or "enhanced plastic" are designed and intended for use in military/aerospace applications or environments. Buyer acknowledges and agrees that any military or aerospace use of TI components which have **not** been so designated is solely at the Buyer's risk, and that Buyer is solely responsible for compliance with all legal and regulatory requirements in connection with such use.

TI has specifically designated certain components as meeting ISO/TS16949 requirements, mainly for automotive use. In any case of use of non-designated products, TI will not be responsible for any failure to meet ISO/TS16949.

Products

Audio	www.ti.com/audio
Amplifiers	amplifier.ti.com
Data Converters	dataconverter.ti.com
DLP® Products	www.dlp.com
DSP	dsp.ti.com
Clocks and Timers	www.ti.com/clocks
Interface	interface.ti.com
Logic	logic.ti.com
Power Mgmt	power.ti.com
Microcontrollers	microcontroller.ti.com
RFID	www.ti-rfid.com
OMAP Applications Processors	www.ti.com/omap
Wireless Connectivity	www.ti.com/wirelessconnectivity

Applications

Automotive and Transportation	www.ti.com/automotive
Communications and Telecom	www.ti.com/communications
Computers and Peripherals	www.ti.com/computers
Consumer Electronics	www.ti.com/consumer-apps
Energy and Lighting	www.ti.com/energy
Industrial	www.ti.com/industrial
Medical	www.ti.com/medical
Security	www.ti.com/security
Space, Avionics and Defense	www.ti.com/space-avionics-defense
Video and Imaging	www.ti.com/video

TI E2E Community

e2e.ti.com