

# MDS Series Micro Snap-acting Detect Switches

## Features/Benefits

- Snap-acting tactile feel
- Small package size
- Available in vertical or right angle PCB mount
- RoHS compliant and compatible

## Typical Applications

- Detect the presence of a mechanical device
- Medical devices
- Consumer electronic devices
- ATCA applications

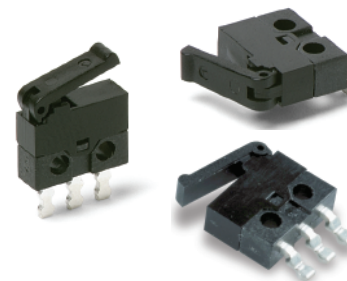

## Specifications

CONTACT RATING: 300mA @ 30 VDC.  
 MECHANICAL & ELECTRICAL LIFE: 30,000 operations.  
 CONTACT RESISTANCE: 100 m Ω max. initial  
 OPERATING TEMPERATURE: -25°C to +70°C.  
 SOLDERABILITY: According to lead free solder profiles.  
 PACKAGING: Available in bulk or tape and reel.  
 OPERATING FORCE: 50g Max.  
 RELEASE FORCE: 3g Min.

## Materials

BASE: PA9T  
 COVER & ACTUATOR: PA9T  
 MOVABLE CONTACT: Copper alloy, silver plated.  
 STATIONARY CONTACTS: Copper alloy, silver plated.  
 TERMINALS: Copper alloy, silver plated.

**NOTE:** MDS series is RoHS compliant, and compatible. See technical data section of this catalog for RoHS compliant and compatible definitions and specifications.

**NOTE:** Specifications and materials listed above are for switches with standard options. For information on specific and custom switches, consult Customer Service Center.



## Build-A-Switch

To order, simply select desired option from each category and place in the appropriate box. Available options are shown and described on pages J-66 through J-70. For additional options not shown in catalog, consult Customer Service Center.

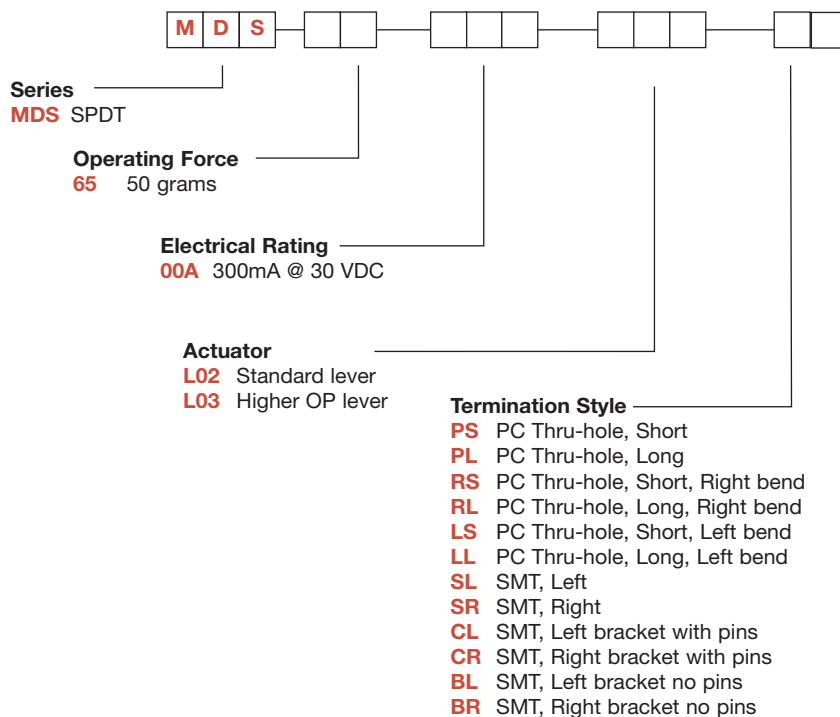

Snap-acting

# MDS Series Micro Snap-acting Detect Switches

## SERIES **MDS** ■■■■■■■■

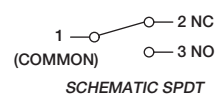
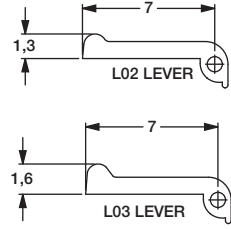
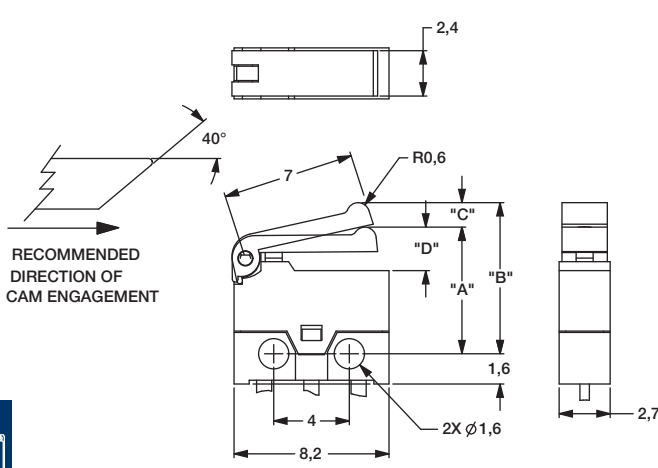

OPERATING CHARACTERISTICS			
		LEVER L02	LEVER L03
OPERATING POSITION	DIM 'A'	6.7±0.5	7.0 +/-0.5
FREE POSITION	DIM 'B'	8 MAX	8.5 MAX
PRETRAVEL	DIM 'C'	1.8 MAX	1.8 MAX
OVER TRAVEL	DIM 'D'	0.3 MIN	0.3 MIN
CONTACT RATING		0.3A @ 30 VDC	0.3A @ 30VDC
OPERATING FORCE		50 GRAMS F. MAX	50 GRAMS F. MAX

Snap-acting

## OPERATING FORCE ■■■■■■■■

OPTION CODE	OPERATING FORCE
<b>65</b>	50 grams max.

## ELECTRICAL RATING ■■■■■■■■

OPTION CODE	ELECTRICAL RATING
<b>00A</b>	300mA @ 30 V DC

## ACTUATOR ■■■■■■■■

**L02** STANDARD LEVER

**L03** HIGHER OP LEVER

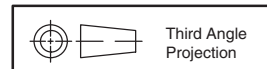
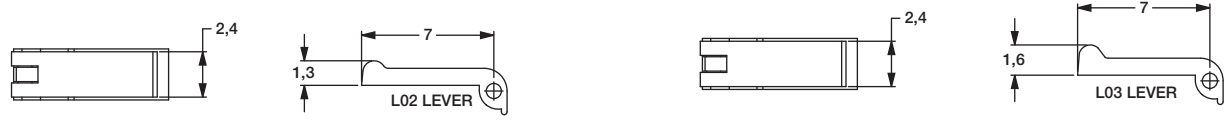

Dimensions are shown: mm  
Specifications and dimensions subject to change

# MDS Series Micro Snap-acting Detect Switches

## TERMINATIONS

### PCB Mounting Pattern

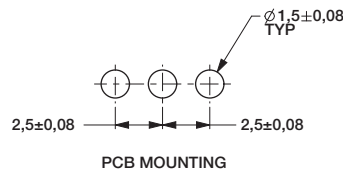

### PS PC THRU-HOLE, SHORT STRAIGHT

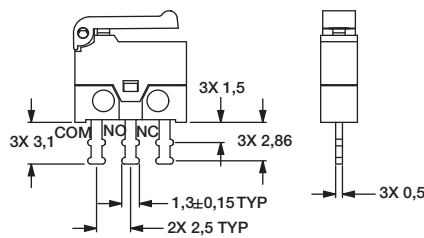

### PL PC THRU-HOLE, LONG STRAIGHT

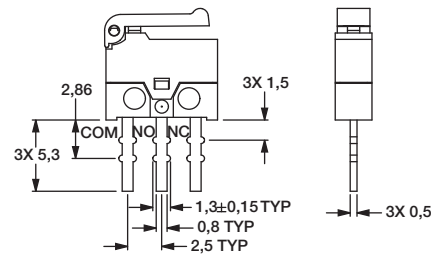

### RS PC THRU-HOLE, SHORT RIGHT BEND

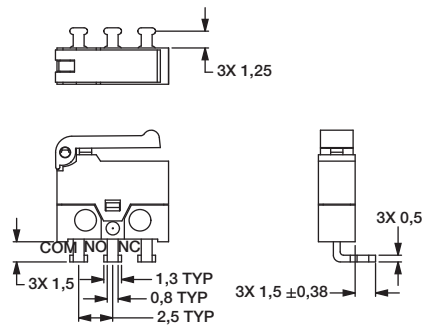

### RL PC THRU-HOLE, LONG SHORT BEND

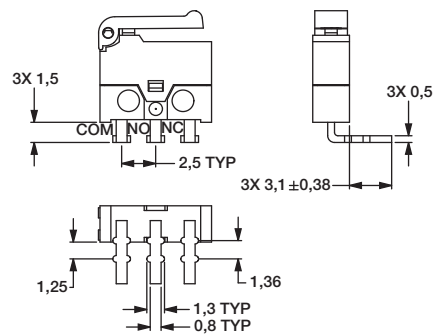

### LS PC THRU-HOLE, SHORT LEFT BEND

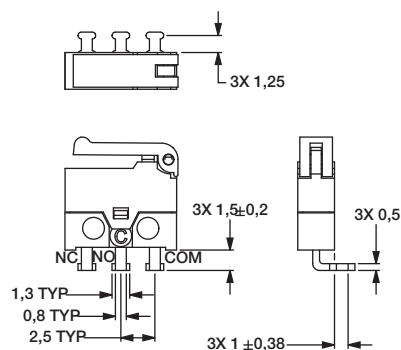

### LL PC THRU-HOLE, LONG LEFT BEND

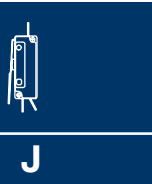
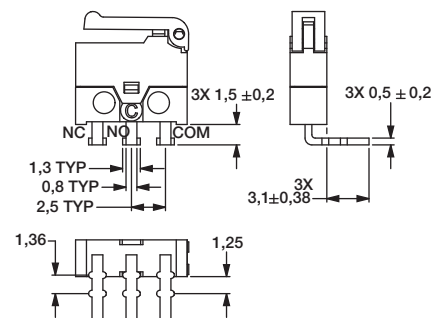

Snap-acting

# MDS Series Micro Snap-acting Detect Switches

## TERMINATIONS

**SL** SMT, LEFT MOUNT

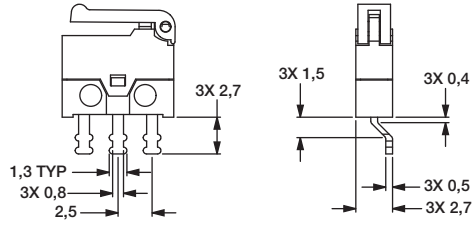

**SMT Mounting Pattern**

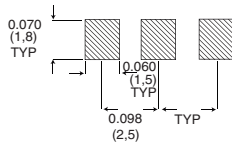

**SR** SMT, RIGHT MOUNT

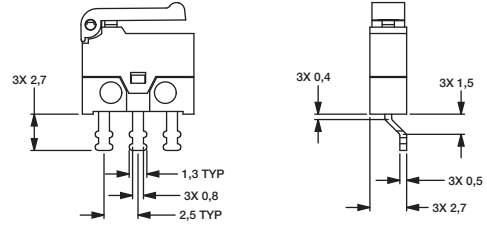

**SMT Mounting Pattern**

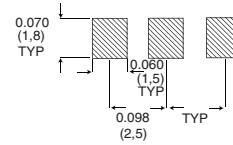

**CL** SMT, LEFT BRACKET WITH PINS

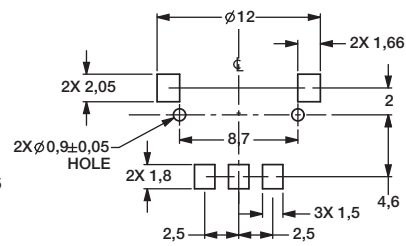
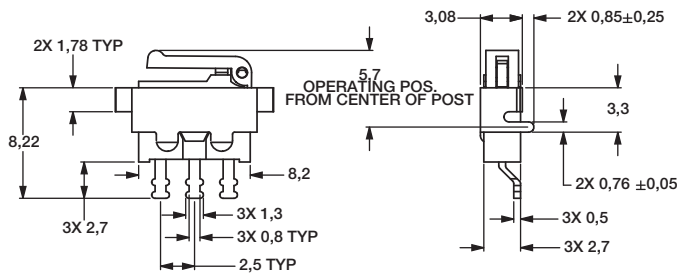
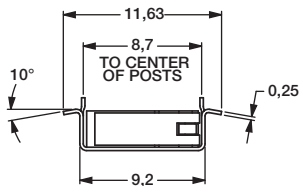

**CR** SMT, RIGHT BRACKET WITH PINS

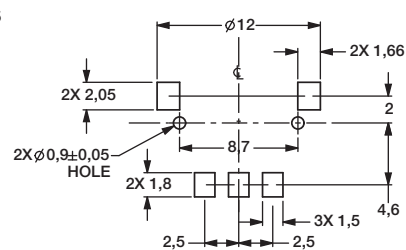
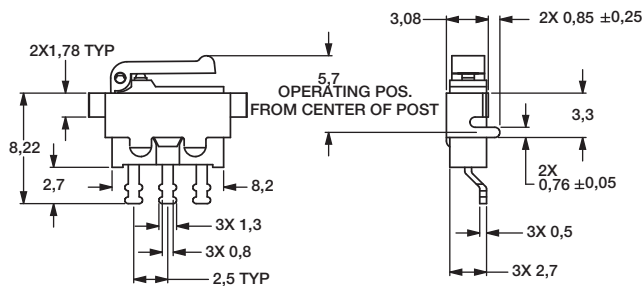
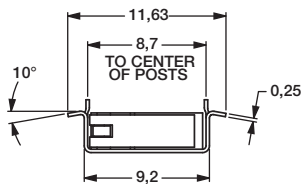

Snap-acting



Snap-acting



Dimensions are shown: mm  
Specifications and dimensions subject to change

# MDS Series Micro Snap-acting Detect Switches

## TERMINATIONS

**BL** SMT, LEFT BRACKET NO PINS

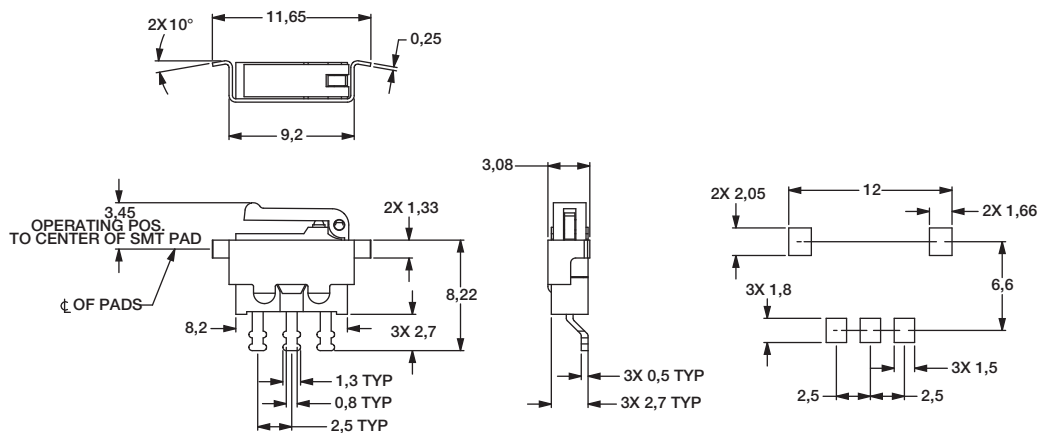

**BR** SMT, RIGHT BRACKET NO PINS

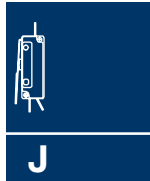
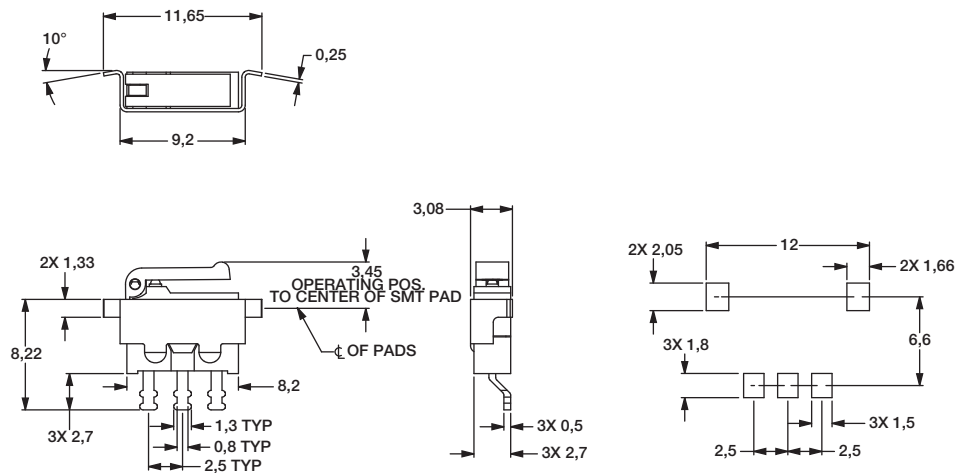

Snap-acting

# MDS Series Micro Snap-acting Detect Switches

## TAPE AND REEL

**SL** SMT, LEFT MOUNT

**SR** SMT, RIGHT MOUNT

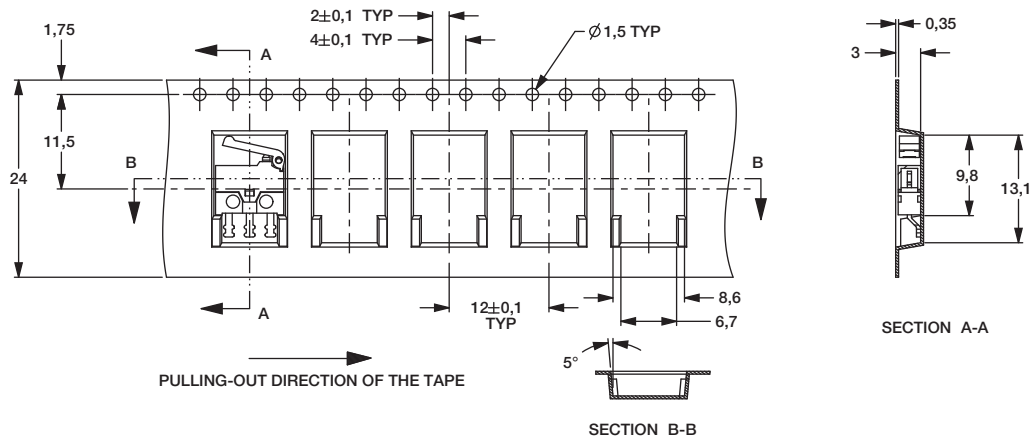

Snap-acting

**CL** SMT, LEFT MOUNT

**CR** SMT, RIGHT MOUNT

**BL** SMT, LEFT MOUNT

**BR** SMT, RIGHT MOUNT

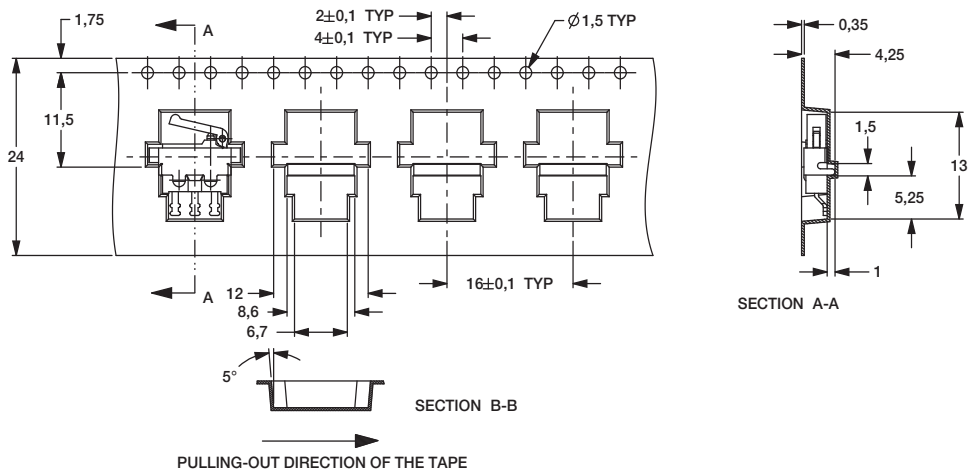

Supplied in carrier tape meeting the EIA-481-2 standard for 24mm tape.

Packaging quantity: SL and SR; 1,600 pieces per reel  
CL, CR, BL and BR; 1,000 pieces per reel

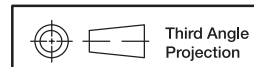

Dimensions are shown: mm  
Specifications and dimensions subject to change