

VCA824 Ultra-Wideband, > 40-dB Gain Adjust Range, Linear in V/V Variable Gain Amplifier

1 Features

- 710-MHz Small-Signal Bandwidth ($G = 2$ V/V)
- 320 MHz, 4- V_{PP} Bandwidth ($G = 10$ V/V)
- 0.1-dB Gain Flatness to 135 MHz
- 2500-V/ μ s Slew Rate
- > 40-dB Gain Adjust Range
- High Gain Accuracy: 20-dB ± 0.3 -dB
- High Output Current: ± 90 mA

2 Applications

- Differential Line Receivers
- Differential Equalizers
- Pulse Amplitude Compensation
- Variable Attenuators
- Voltage-tunable Active Filters

3 Description

The VCA824 is a DC-coupled, wideband, linear-in-V/V, continuously variable, voltage-controlled gain amplifier. The device provides a differential input to single-ended conversion with a high-impedance gain control input used to vary the gain down 40 dB from the nominal maximum gain set by the gain resistor (R_G) and feedback resistor (R_F).

The VCA824 internal architecture consists of two input buffers and an output current feedback amplifier stage integrated with a multiplier core to provide a complete variable gain amplifier (VGA) system that does not require external buffering. The maximum gain is set externally with two resistors, providing flexibility in designs. The maximum gain is intended to be set between 2 V/V and 40 V/V. Operating from ± 5 -V supplies, the gain control voltage for the VCA824 adjusts the gain linearly in V/V as the control voltage varies from 1 V to -1 V. For example, set for a maximum gain of 10 V/V, the VCA824 provides 10 V/V, at 1-V input, to 0.1 V/V at -1 -V input of gain control range. The VCA824 offers excellent gain linearity. For a 20-dB maximum gain, and a gain-control input voltage varying between 0 V and 1 V, the gain does not deviate by more than ± 0.3 -dB (maximum at 25°C).

Device Information⁽¹⁾

PART NUMBER	PACKAGE	BODY SIZE (NOM)
VCA824	SOIC (14)	8.65 mm x 3.91 mm
	VSSOP (10)	3.00 mm x 3.00 mm

(1) For all available packages, see the orderable addendum at the end of the data sheet.

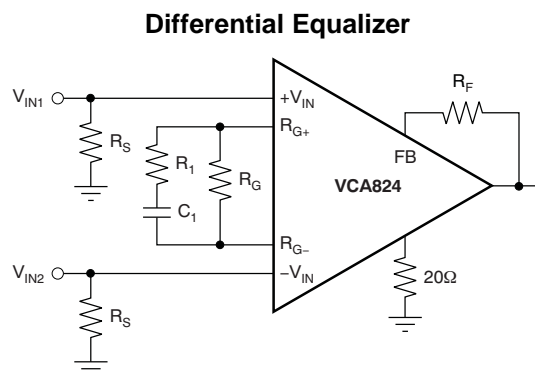

Differential Equalization of an RC Load

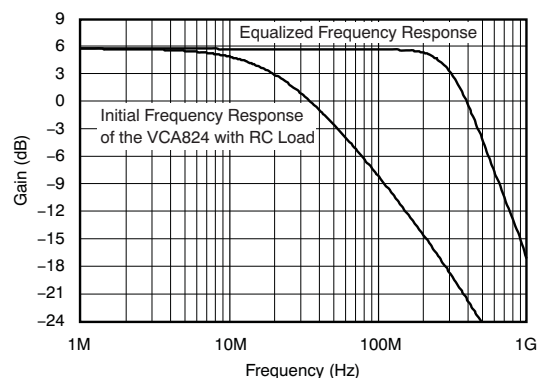

Table of Contents

1 Features	1	8.2 Functional Block Diagram	19
2 Applications	1	8.3 Feature Description	19
3 Description	1	8.4 Device Functional Modes	19
4 Revision History	2	9 Application and Implementation	22
5 Device Comparison Table	3	9.1 Application Information	22
6 Pin Configuration and Functions	3	9.2 Typical Application	28
7 Specifications	4	10 Power Supply Recommendations	30
7.1 Absolute Maximum Ratings	4	11 Layout	30
7.2 ESD Ratings	4	11.1 Layout Guidelines	30
7.3 Recommended Operating Conditions	4	11.2 Layout Example	31
7.4 Thermal Information	4	11.3 Thermal Considerations	31
7.5 Electrical Characteristics: $V_S = \pm 5\text{ V}$	5	12 Device and Documentation Support	32
7.6 Typical Characteristics: $V_S = \pm 5\text{ V}$, $A_{VMAX} = 2\text{ V/V}$...	7	12.1 Device Support	32
7.7 Typical Characteristics: $V_S = \pm 5\text{ V}$, $A_{VMAX} = 10$		12.2 Community Resources	32
V/V	11	12.3 Trademarks	32
7.8 Typical Characteristics: $V_S = \pm 5\text{ V}$, $A_{VMAX} = 40$		12.4 Electrostatic Discharge Caution	32
V/V	15	12.5 Glossary	32
8 Detailed Description	19	13 Mechanical, Packaging, and Orderable Information	32
8.1 Overview	19		

4 Revision History

Changes from Revision C (December 2008) to Revision D	Page
<ul style="list-style-type: none"> Added <i>Pin Configuration and Functions</i> section, <i>ESD Ratings</i> table, <i>Feature Description</i> section, <i>Device Functional Modes</i>, <i>Application and Implementation</i> section, <i>Power Supply Recommendations</i> section, <i>Layout</i> section, <i>Device and Documentation Support</i> section, and <i>Mechanical, Packaging, and Orderable Information</i> section Deleted Thermal Characteristics rows from <i>Electrical Characteristics</i> 	1 5
Changes from Revision B (August 2008) to Revision C	Page
<ul style="list-style-type: none"> Revised second paragraph in the <i>Wideband Variable Gain Amplifier Operation</i> section describing pin 9 	28
Changes from Revision A (December 2007) to Revision B	Page
<ul style="list-style-type: none"> Changed storage temperature range rating in Absolute Maximum Ratings table from $-40\text{ }^\circ\text{C}$ to $125\text{ }^\circ\text{C}$ to $-65\text{ }^\circ\text{C}$ to $125\text{ }^\circ\text{C}$ 	4
Changes from Original (November 2007) to Revision A	Page
<ul style="list-style-type: none"> Added typical value for output impedance Changed wording of explanation for X2Y capacitor usage at end of paragraph 	6 28

5 Device Comparison Table

SINGLES	DUALS	GAIN ADJUST RANGE (dB)	INPUT NOISE (nV/ $\sqrt{\text{Hz}}$)	SIGNAL BANDWIDTH (MHz)
VCA810	—	80	2.4	35
—	VCA2612	45	1.25	80
—	VCA2613	45	1	80
—	VCA2615	52	0.8	50
—	VCA2617	48	4.1	50
VCA820	—	40	8.2	150
VCA821	—	40	6.0	420
VCA822	—	40	8.2	150
VCA824	—	40	6.0	420

6 Pin Configuration and Functions



NC = No Connection

Pin Functions

NAME	PIN		I/O	DESCRIPTION
	SOIC	VSSOP		
V_{CC}	1,14	2	P	Positive supply voltage
V_G	2	3	I	Gain control voltage
$+V_{IN}$	3	4	I	noninverting input
$+R_G$	4	5	I	Gain set resistor noninverting input
$-R_G$	5	6	I	Gain set resistor inverting input
$-V_{IN}$	6	7	I	Inverting input
$-V_{CC}$	7,8	8	P	Negative supply voltage
V_{REF}	9	—	I	Output reference voltage (Non- Inverting input of output buffer)
V_{OUT}	10	9	O	Output voltage
GND	11	10	P	Ground
FB	12	1	I	Feedback resistor (inverting input of output buffer)
NC	13	—	—	Not connected

7 Specifications

7.1 Absolute Maximum Ratings

over operating free-air temperature range (unless otherwise noted)⁽¹⁾

	MIN	MAX	UNIT
Power supply		±6.5	V
Internal power dissipation	See Thermal Information		
Input voltage		±V _S	V
Junction temperature (T _J)		260	°C
Junction temperature (T _J), continuous operation		140	°C
Storage temperature	–65	125	°C

- (1) Stresses beyond those listed under *Absolute Maximum Ratings* may cause permanent damage to the device. These are stress ratings only, which do not imply functional operation of the device at these or any other conditions beyond those indicated under *Recommended Operating Conditions*. Exposure to absolute-maximum-rated conditions for extended periods may affect device reliability.

7.2 ESD Ratings

		VALUE	UNIT
V _(ESD) Electrostatic discharge	Human body model (HBM), per ANSI/ESDA/JEDEC JS-001 ⁽¹⁾	±2000	V
	Charged device model (CDM), per JEDEC specification JESD22-C101 ⁽²⁾	±500	
	Machine model (MM)	±200	

- (1) JEDEC document JEP155 states that 500-V HBM allows safe manufacturing with a standard ESD control process.
 (2) JEDEC document JEP157 states that 250-V CDM allows safe manufacturing with a standard ESD control process.

7.3 Recommended Operating Conditions

over operating free-air temperature range (unless otherwise noted)

	MIN	NOM	MAX	UNIT
Operating voltage	7	10	12	V
Operating temperature	–40	25	85	°C

7.4 Thermal Information

THERMAL METRIC ⁽¹⁾	VCA824		UNIT
	D (SOIC)	DGS (VSSOP)	
	14 PINS	10 PINS	
R _{θJA} Junction-to-ambient thermal resistance	90.3	173.1	°C/W
R _{θJC(top)} Junction-to-case (top) thermal resistance	49.8	46.6	°C/W
R _{θJB} Junction-to-board thermal resistance	44.9	94.3	°C/W
ψ _{JT} Junction-to-top characterization parameter	13.8	2.2	°C/W
ψ _{JB} Junction-to-board characterization parameter	44.6	92.7	°C/W
R _{θJC(bot)} Junction-to-case (bottom) thermal resistance	n/a	n/a	°C/W

- (1) For more information about traditional and new thermal metrics, see the *Semiconductor and IC Package Thermal Metrics* application report, [SPRA953](#)

7.5 Electrical Characteristics: $V_S = \pm 5\text{ V}$

At $A_{VMAX} = 10\text{ V/V}$, $V_G = 1\text{ V}$, $R_F = 402\ \Omega$, $R_G = 80\ \Omega$, and $R_L = 100\ \Omega$, unless otherwise noted.

PARAMETER		TEST CONDITIONS		TEST LEVEL ⁽¹⁾	MIN	TYP	MAX	UNIT	
AC PERFORMANCE									
Small-Signal Bandwidth	$A_{VMAX} = 2\text{ V/V}$, $V_G = 1\text{ V}$, $V_O = 500\text{ mV}_{PP}$		C			710		MHz	
	$A_{VMAX} = 10\text{ V/V}$, $V_G = 1\text{ V}$, $V_O = 500\text{ mV}_{PP}$					420			
	$A_{VMAX} = 40\text{ V/V}$, $V_G = 1\text{ V}$, $V_O = 500\text{ mV}_{PP}$					170			
Large-Signal Bandwidth	$A_{VMAX} = 10\text{ V/V}$, $V_G = 1\text{ V}$, $V_O = 4\text{ V}_{PP}$		C			320		MHz	
Gain Control Bandwidth	$V_O = 200\text{ mV}_{PP}$, $T_A = 25^\circ\text{C}$	$T_A = 25^\circ\text{C}$	B			240	330	MHz	
		$T_A = 0^\circ\text{C to } 70^\circ\text{C}$				235			
		$T_A = -40^\circ\text{C to } 85^\circ\text{C}$				235			
Bandwidth for 0.1-dB Flatness	$A_{VMAX} = 10\text{ V/V}$, $V_G = 1\text{ V}$, $V_O = 2\text{ V}_{PP}$		C			135		MHz	
Slew Rate	$A_{VMAX} = 10\text{ V/V}$, $V_G = 1\text{ V}$, $V_O = 4\text{ V Step}$	$T_A = 25^\circ\text{C}$	B			1800	2500	V/ μs	
		$T_A = 0^\circ\text{C to } 70^\circ$				1700			
		$T_A = -40^\circ\text{C to } 85^\circ\text{C}$				1700			
Rise-and-Fall Time	$A_{VMAX} = 10\text{ V/V}$, $V_G = 1\text{ V}$, $V_O = 4\text{ V Step}$	$T_A = 25^\circ\text{C}$	B			1.5	1.8	ns	
		$T_A = 0^\circ\text{C to } 70^\circ\text{C}$				1.9			
		$T_A = -40^\circ\text{C to } 85^\circ\text{C}$				1.9			
Settling Time to 0.01%	$A_{VMAX} = 10\text{ V/V}$, $V_G = 1\text{ V}$, $V_O = 4\text{ V Step}$		C			11		ns	
Harmonic Distortion	2nd-Harmonic	$V_O = 2\text{ V}_{PP}$, $f = 20\text{ MHz}$	$T_A = 25^\circ\text{C}$	B			-64	-66	dBc
			$T_A = 0^\circ\text{C to } 70^\circ\text{C}$				-64		
			$T_A = -40^\circ\text{C to } 85^\circ\text{C}$				-64		
	3rd-Harmonic	$V_O = 2\text{ V}_{PP}$, $f = 20\text{ MHz}$	$T_A = 25^\circ\text{C}$	B			-61	-63	dBc
			$T_A = 0^\circ\text{C to } 70^\circ\text{C}$				-61		
			$T_A = -40^\circ\text{C to } 85^\circ\text{C}$				-61		
Input Voltage Noise	$f > 100\text{ kHz}$		C			6		nV/ $\sqrt{\text{Hz}}$	
Input Current Noise	$f > 100\text{ kHz}$		C			2.6		pA/ $\sqrt{\text{Hz}}$	
GAIN CONTROL									
Gain Error	$A_{VMAX} = 10\text{ V/V}$, $V_G = 1\text{ V}$	$T_A = 25^\circ\text{C}$	A				± 0.1	± 0.4	dB
		$T_A = 0^\circ\text{C to } 70^\circ\text{C}$					± 0.5		
		$T_A = -40^\circ\text{C to } 85^\circ\text{C}$					± 0.6		
Gain Deviation	$A_{VMAX} = 10\text{ V/V}$, $0 < V_G < 1$	$T_A = 25^\circ\text{C}$	A				± 0.05	± 0.3	dB
		$T_A = 0^\circ\text{C to } 70^\circ\text{C}$					± 0.34		
		$T_A = -40^\circ\text{C to } 85^\circ\text{C}$					± 0.37		
Gain Deviation	$A_{VMAX} = 10\text{ V/V}$, $-0.8 < V_G < 1$	$T_A = 25^\circ\text{C}$	A				± 1.06	± 1.9	dB
		$T_A = 0^\circ\text{C to } 70^\circ\text{C}$					± 2.1		
		$T_A = -40^\circ\text{C to } 85^\circ\text{C}$					± 2.2		
Gain at $V_G = -0.9\text{ V}$	Relative to max gain	$T_A = 25^\circ\text{C}$	A				-26	-24	dB
		$T_A = 0^\circ\text{C to } 70^\circ\text{C}$					-24		
		$T_A = -40^\circ\text{C to } 85^\circ\text{C}$					-23		
Gain Control Bias Current	$T_A = 25^\circ\text{C}$	$T_A = 25^\circ\text{C}$	A				22	30	μA
		$T_A = 0^\circ\text{C to } 70^\circ\text{C}$					35		
		$T_A = -40^\circ\text{C to } 85^\circ\text{C}$					37		
Average Gain Control Bias Current Drift	$T_A = 0^\circ\text{C to } 70^\circ\text{C}$	$T_A = 0^\circ\text{C to } 70^\circ\text{C}$	B				± 100	± 100	nA/ $^\circ\text{C}$
		$T_A = -40^\circ\text{C to } 85^\circ\text{C}$					± 100		
Gain Control Input Impedance	$T_A = 25^\circ\text{C}$		C			1.5 0.6		M Ω pF	
DC PERFORMANCE									
Input Offset Voltage	$A_{VMAX} = 10\text{ V/V}$, $V_{CM} = 0\text{ V}$, $V_G = 1\text{ V}$	$T_A = 25^\circ\text{C}$	A				± 4	± 17	mV
		$T_A = 0^\circ\text{C to } 70^\circ$					± 17.8		
		$T_A = -40^\circ\text{C to } 85^\circ\text{C}$					± 19		
Average Input Offset Voltage Drift	$A_{VMAX} = 10\text{ V/V}$, $V_{CM} = 0\text{ V}$, $V_G = 1\text{ V}$	$T_A = 0^\circ\text{C to } 70^\circ\text{C}$	B				± 30	± 30	$\mu\text{V}/^\circ\text{C}$
		$T_A = -40^\circ\text{C to } 85^\circ\text{C}$					± 30		
Input Bias Current	$A_{VMAX} = 10\text{ V/V}$, $V_{CM} = 0\text{ V}$, $V_G = 1\text{ V}$	$T_A = 25^\circ\text{C}$	A				19	25	μA
		$T_A = 0^\circ\text{C to } 70^\circ\text{C}$					29		
		$T_A = -40^\circ\text{C to } 85^\circ\text{C}$					31		

(1) Test levels: (A) 100% tested at 25°C. Over temperature limits set by characterization and simulation. (B) Limits set by characterization and simulation. (C) Typical value only for information.

Electrical Characteristics: $V_S = \pm 5\text{ V}$ (continued)

 At $A_{VMAX} = 10\text{ V/V}$, $V_G = 1\text{ V}$, $R_F = 402\ \Omega$, $R_G = 80\ \Omega$, and $R_L = 100\ \Omega$, unless otherwise noted.

PARAMETER		TEST CONDITIONS		TEST LEVEL ⁽¹⁾	MIN	TYP	MAX	UNIT
Average Input Bias Current Drift	$A_{VMAX} = 10\text{ V/V}$, $V_{CM} = 0\text{ V}$, $V_G = 1\text{ V}$	$T_A = 0^\circ\text{C to } 70^\circ\text{C}$	B				± 90	nA/ $^\circ\text{C}$
		$T_A = -40^\circ\text{C to } 85^\circ\text{C}$				± 90		
Input Offset Current	$A_{VMAX} = 10\text{ V/V}$, $V_{CM} = 0\text{ V}$, $V_G = 1\text{ V}$	$T_A = 25^\circ\text{C}$	A			± 0.5	± 2.5	μA
		$T_A = 0^\circ\text{C to } 70^\circ\text{C}$				± 3.2		
		$T_A = -40^\circ\text{C to } 85^\circ\text{C}$				± 3.5		
Average Input Offset Current Drift	$A_{VMAX} = 10\text{ V/V}$, $V_{CM} = 0\text{ V}$, $V_G = 1\text{ V}$	$T_A = 0^\circ\text{C to } 70^\circ\text{C}$	B				± 16	nA/ $^\circ\text{C}$
		$T_A = -40^\circ\text{C to } 85^\circ\text{C}$				± 16		
Max Current Through Gain Resistance	$T_A = 25^\circ\text{C}$ $T_A = 0^\circ\text{C to } 70^\circ\text{C}$ $T_A = -40^\circ\text{C to } 85^\circ\text{C}$		B			± 2.6	± 2.55	mA
						± 2.55		
						± 2.5		
INPUT								
Most Positive Common-Mode Input Voltage	$R_L = 100\ \Omega$	$T_A = 25^\circ\text{C}$	A		1.6	1.6		V
		$T_A = 0^\circ\text{C to } 70^\circ\text{C}$			1.6			
		$T_A = -40^\circ\text{C to } 85^\circ\text{C}$			1.6			
Most Negative Common-Mode Input Voltage	$R_L = 100\ \Omega$	$T_A = 25^\circ\text{C}$	A			-2.1	-2.1	V
		$T_A = 0^\circ\text{C to } 70^\circ\text{C}$				-2.1		
		$T_A = -40^\circ\text{C to } 85^\circ\text{C}$				-2.1		
Common-Mode Rejection Ratio	$V_{CM} = \pm 0.5\text{ V}$	$T_A = 25^\circ\text{C}$	A			80	65	dB
		$T_A = 0^\circ\text{C to } 70^\circ\text{C}$				60		
		$T_A = -40^\circ\text{C to } 85^\circ\text{C}$				60		
Input Impedance	Differential		C			1 1		M Ω pF
	Common-Mode		C			1 2		M Ω pF
OUTPUT								
Output Voltage Swing	$R_L = 1\text{ k}\Omega$	$T_A = 25^\circ\text{C}$	A		± 3.6	± 3.9		V
		$T_A = 0^\circ\text{C to } 70^\circ\text{C}$			± 3.4			
		$T_A = -40^\circ\text{C to } 85^\circ\text{C}$			± 3.3			
	$R_L = 100\ \Omega$	$T_A = 25^\circ\text{C}$	A		± 3.5	± 3.6		V
		$T_A = 0^\circ\text{C to } 70^\circ\text{C}$			± 3.3			
		$T_A = -40^\circ\text{C to } 85^\circ\text{C}$			± 3.2			
Output Current	$V_O = 0\text{ V}$, $R_L = 10\ \Omega$	$T_A = 25^\circ\text{C}$	A		± 60	± 90		mA
		$T_A = 0^\circ\text{C to } 70^\circ\text{C}$			50			
		$T_A = -40^\circ\text{C to } 85^\circ\text{C}$			45			
Output Impedance	$A_{VMAX} = 10\text{ V/V}$, $f > 100\text{ kHz}$		C			0.01		Ω
POWER SUPPLY								
Specified Operating Voltage			C			± 5		V
Minimum Operating Voltage	$T_A = 25^\circ\text{C}$ $T_A = 0^\circ\text{C to } 70^\circ\text{C}$ $T_A = -40^\circ\text{C to } 85^\circ\text{C}$		B		± 4			V
					± 4			
					± 4			
Maximum Operating Voltage	$T_A = 25^\circ\text{C}$ $T_A = 0^\circ\text{C to } 70^\circ\text{C}$ $T_A = -40^\circ\text{C to } 85^\circ\text{C}$		A				± 6	V
						± 6		
						± 6		
Maximum Quiescent Current	$V_G = 0\text{ V}$	$T_A = 25^\circ\text{C}$	A			36.5	37.5	mA
		$T_A = 0^\circ\text{C to } 70^\circ\text{C}$				38		
		$T_A = -40^\circ\text{C to } 85^\circ\text{C}$				38.5		
Minimum Quiescent Current	$V_G = 0\text{ V}$	$T_A = 25^\circ\text{C}$	A			36.5	35	mA
		$T_A = 0^\circ\text{C to } 70^\circ\text{C}$				34.5		
		$T_A = -40^\circ\text{C to } 85^\circ\text{C}$				34		
Power-Supply Rejection Ratio (-PSRR)	$V_G = 1\text{ V}$	$T_A = 25^\circ\text{C}$	A		-61	-68		dB
		$T_A = 0^\circ\text{C to } 70^\circ\text{C}$			-59			
		$T_A = -40^\circ\text{C to } 85^\circ\text{C}$			-58			

7.6 Typical Characteristics: $V_S = \pm 5\text{ V}$, $A_{VMAX} = 2\text{ V/V}$

At $T_A = 25^\circ\text{C}$, $R_L = 100\ \Omega$, $R_F = 453\ \Omega$, $R_G = 453\ \Omega$, $V_G = 1\text{ V}$, V_{IN} = single-ended input on $+V_{IN}$ with $-V_{IN}$ at ground, and 14-Pin SOIC package, unless otherwise noted.

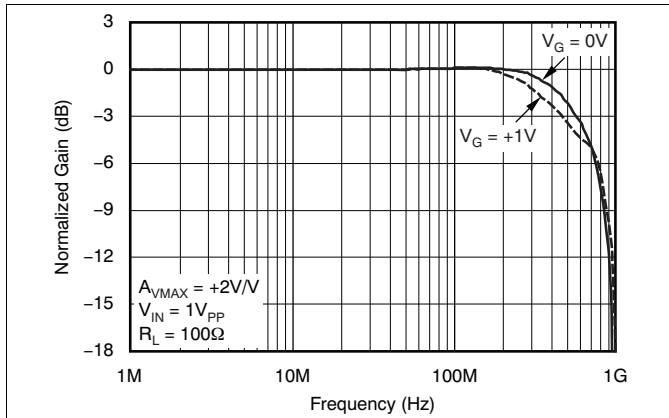

Figure 1. Small-Signal Frequency Response

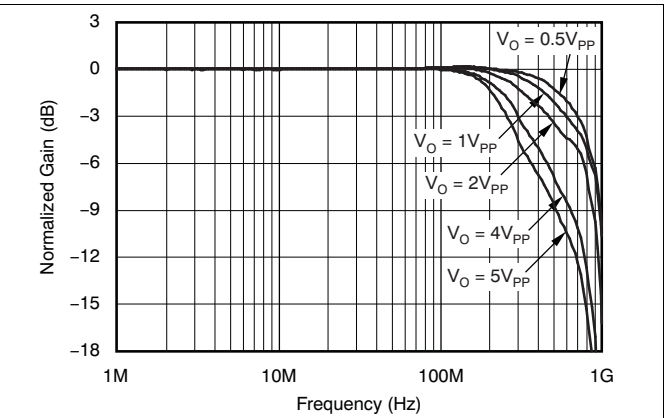

Figure 2. Large-Signal Frequency Response

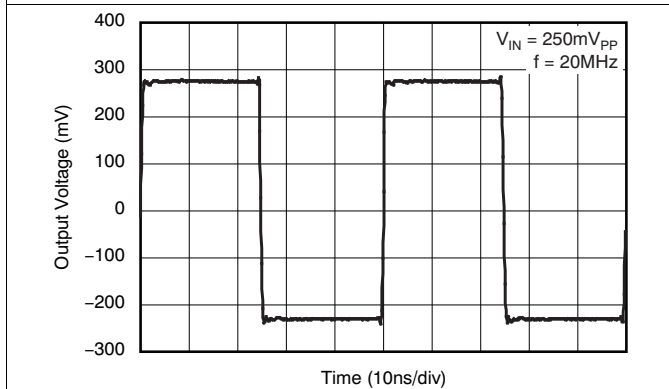

Figure 3. Small-Signal Pulse Response

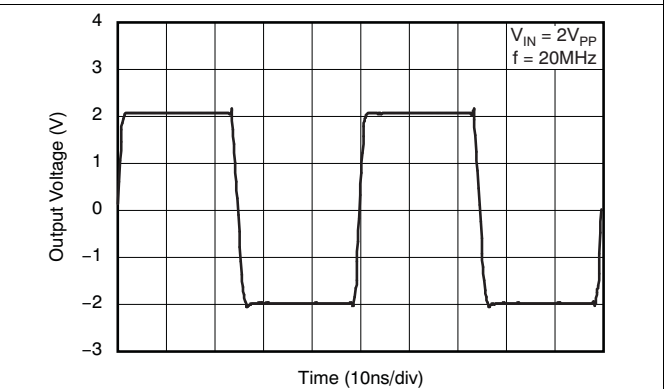

Figure 4. Large-Signal Pulse Response

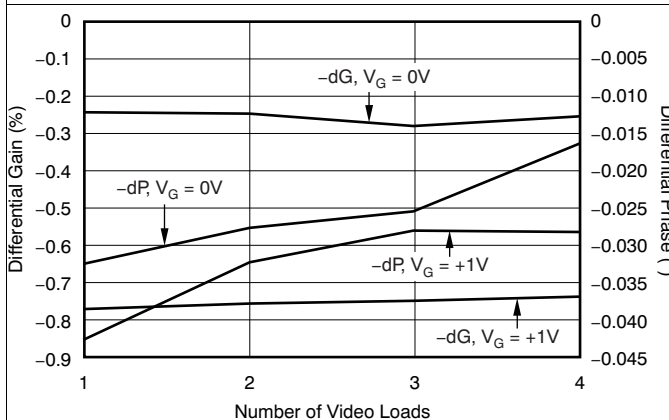

Figure 5. Composite Video dG/dP

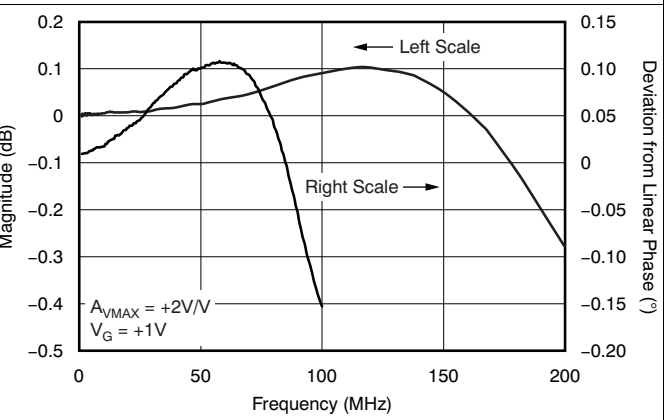

Figure 6. Gain Flatness, Deviation From Linear Phase

Typical Characteristics: $V_S = \pm 5\text{ V}$, $A_{VMAX} = 2\text{ V/V}$ (continued)

At $T_A = 25^\circ\text{C}$, $R_L = 100\ \Omega$, $R_F = 453\ \Omega$, $R_G = 453\ \Omega$, $V_G = 1\text{ V}$, V_{IN} = single-ended input on $+V_{IN}$ with $-V_{IN}$ at ground, and 14-Pin SOIC package, unless otherwise noted.

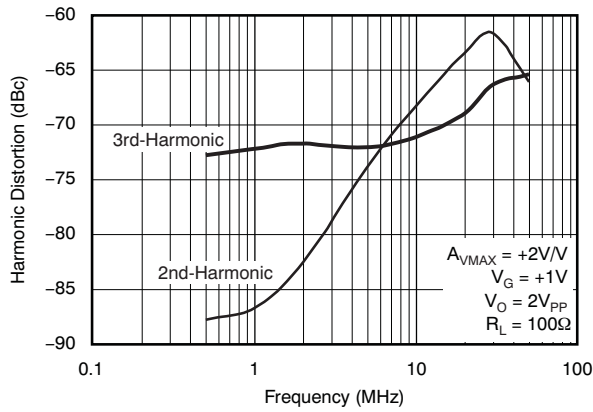

Figure 7. Harmonic Distortion vs Frequency

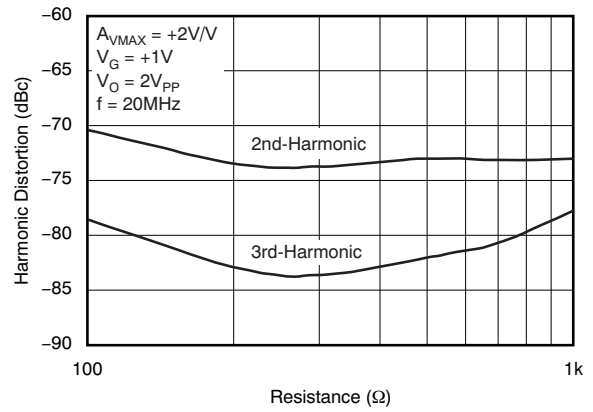

Figure 8. Harmonic Distortion vs Load Resistance

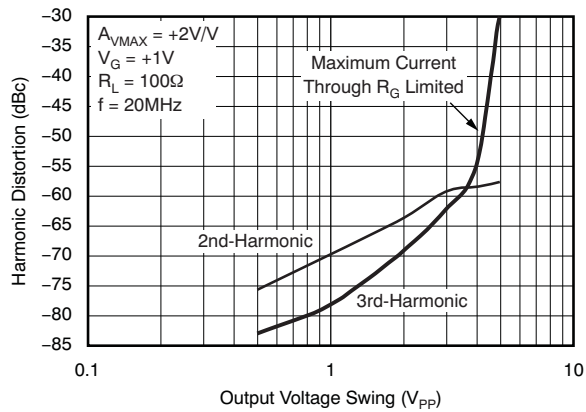

Figure 9. Harmonic Distortion vs Output Voltage

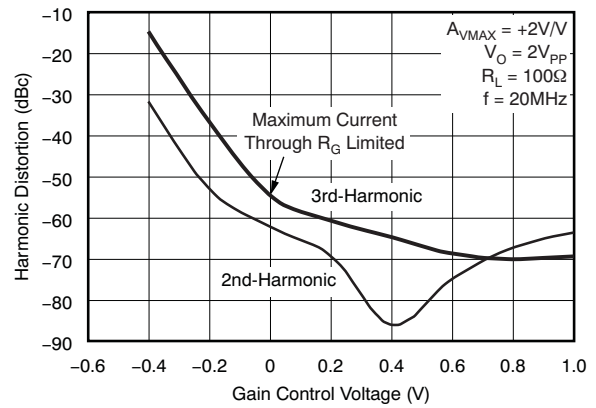

Figure 10. Harmonic Distortion vs Gain Control Voltage

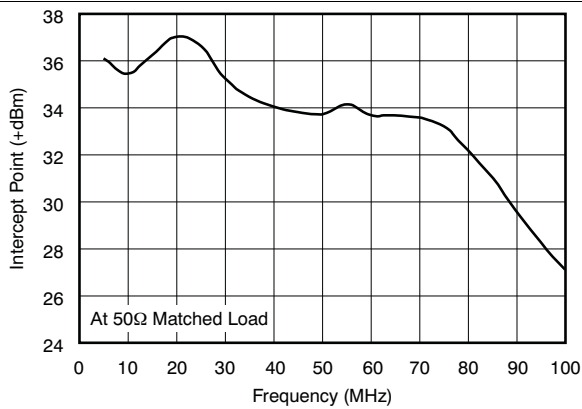

Figure 11. Two-Tone, 3rd-Order Intermodulation Intercept

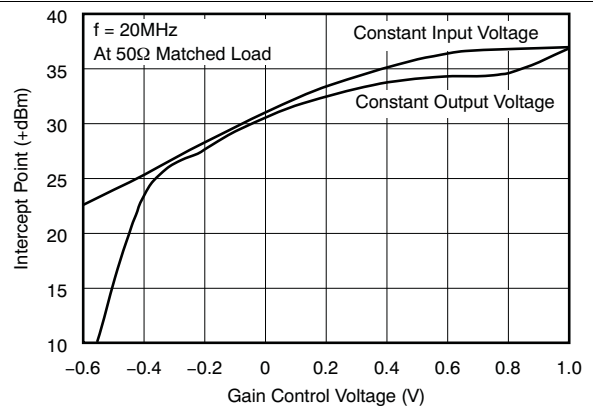

Figure 12. Two-Tone, 3rd-Order Intermodulation Intercept vs Gain Control Voltage

Typical Characteristics: $V_S = \pm 5\text{ V}$, $A_{V_{MAX}} = 2\text{ V/V}$ (continued)

At $T_A = 25^\circ\text{C}$, $R_L = 100\ \Omega$, $R_F = 453\ \Omega$, $R_G = 453\ \Omega$, $V_G = 1\text{ V}$, V_{IN} = single-ended input on $+V_{IN}$ with $-V_{IN}$ at ground, and 14-Pin SOIC package, unless otherwise noted.

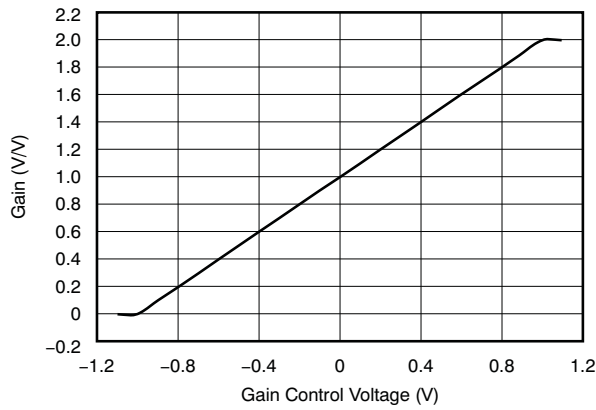

Figure 13. Gain vs Gain Control Voltage

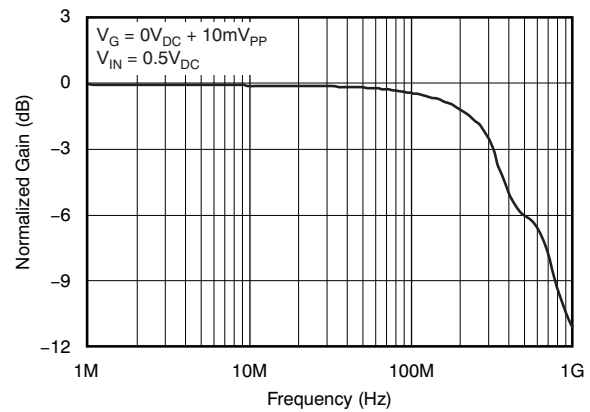

Figure 14. Gain Control Frequency Response

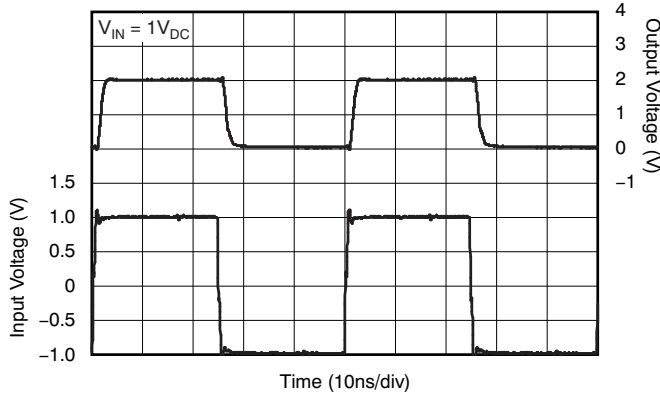

Figure 15. Gain Control Pulse Response

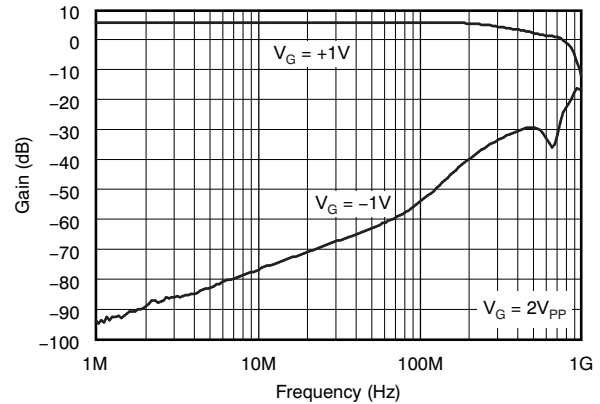

Figure 16. Fully-Attenuated Response

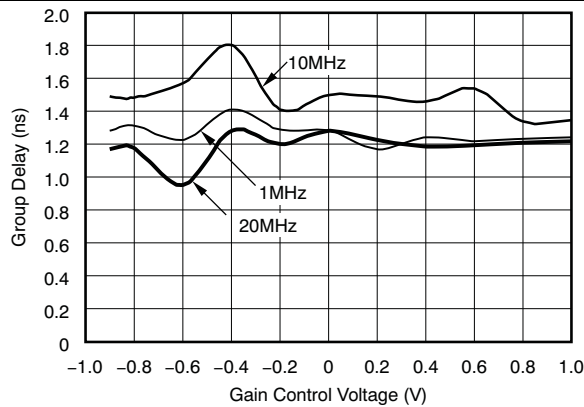

Figure 17. Group Delay vs Gain Control Voltage

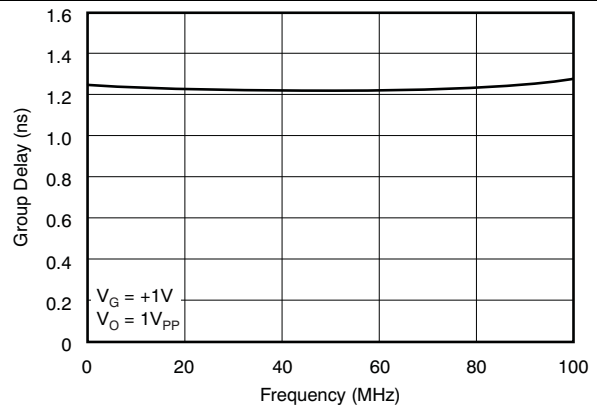

Figure 18. Group Delay vs Frequency

Typical Characteristics: $V_S = \pm 5\text{ V}$, $A_{VMAX} = 2\text{ V/V}$ (continued)

At $T_A = 25^\circ\text{C}$, $R_L = 100\ \Omega$, $R_F = 453\ \Omega$, $R_G = 453\ \Omega$, $V_G = 1\text{ V}$, V_{IN} = single-ended input on $+V_{IN}$ with $-V_{IN}$ at ground, and 14-Pin SOIC package, unless otherwise noted.

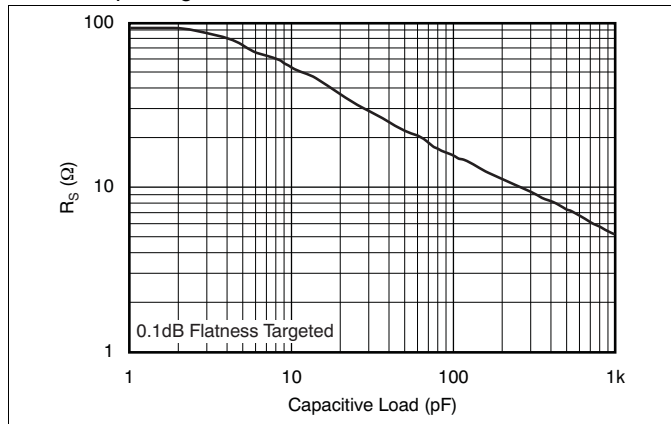

Figure 19. Recommended R_S vs Capacitive Load

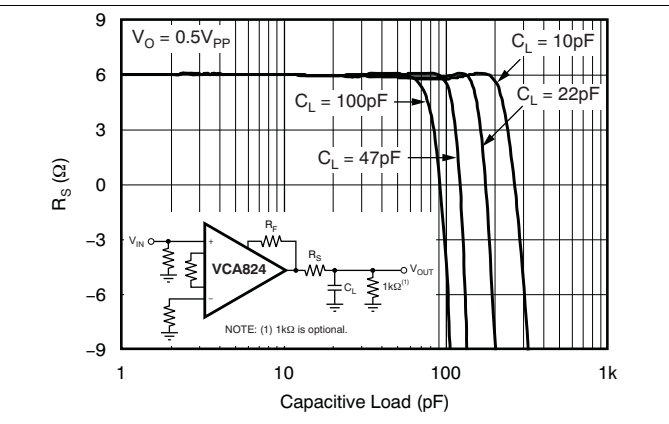

Figure 20. Frequency Response vs Capacitive Load

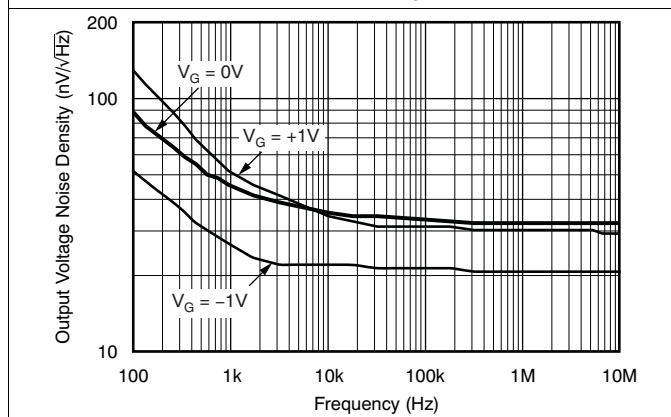

Figure 21. Output Voltage Density

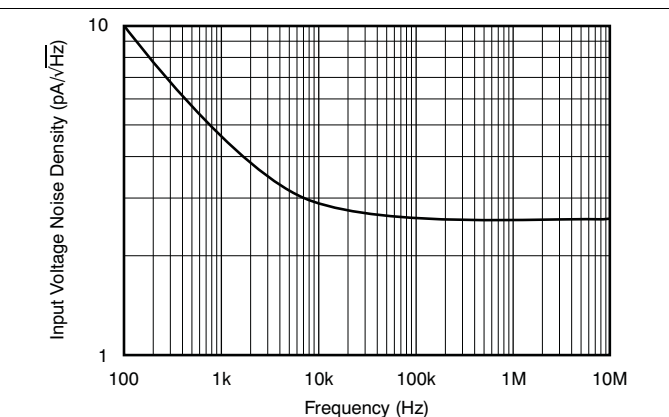

Figure 22. Input Current Noise Density

7.7 Typical Characteristics: $V_S = \pm 5\text{ V}$, $A_{VMAX} = 10\text{ V/V}$

At $T_A = 25^\circ\text{C}$, $R_L = 100\ \Omega$, $R_F = 402\ \Omega$, $R_G = 80\ \Omega$, $V_G = 1\text{ V}$, and V_{IN} = single-ended input on $+V_{IN}$ with $-V_{IN}$ at ground, unless otherwise noted.

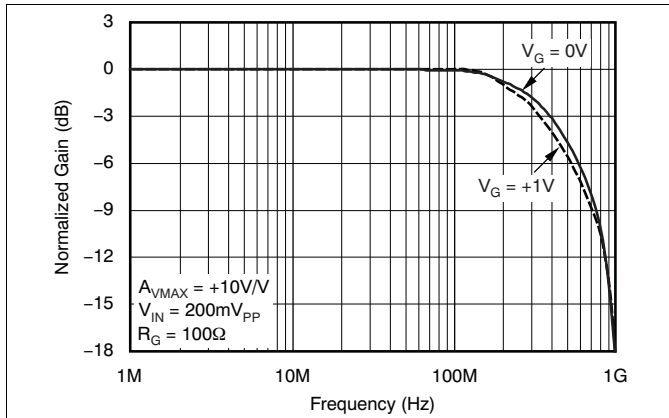

Figure 23. Small-Signal Frequency Response

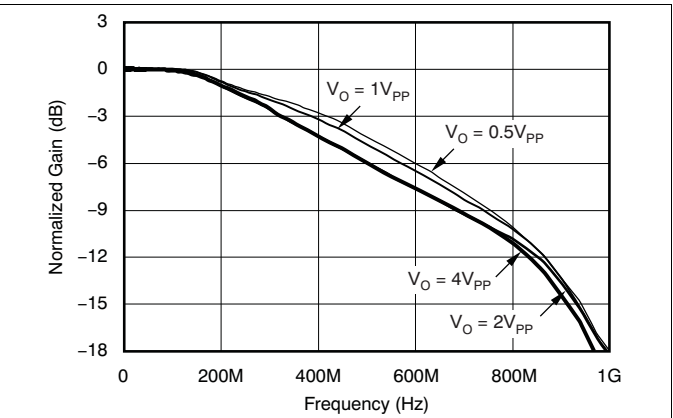

Figure 24. Large-Signal Frequency Response

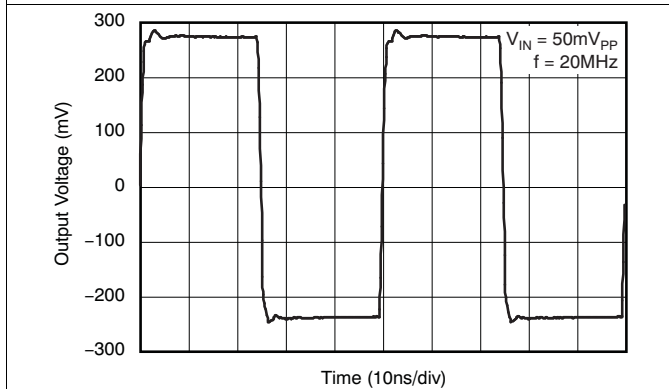

Figure 25. Small-Signal Pulse Response

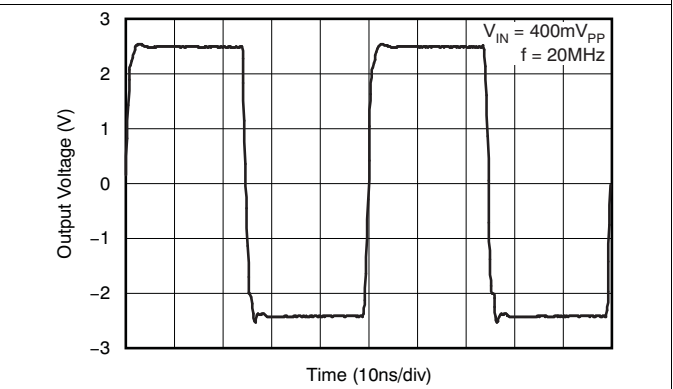

Figure 26. Large-Signal Pulse Response

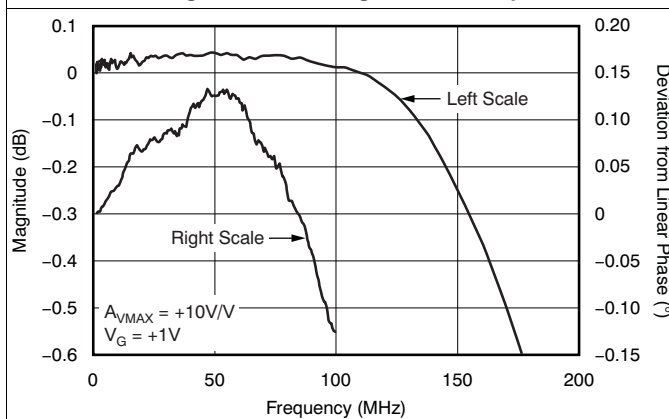

Figure 27. Gain Flatness, Deviation from Linear Phase

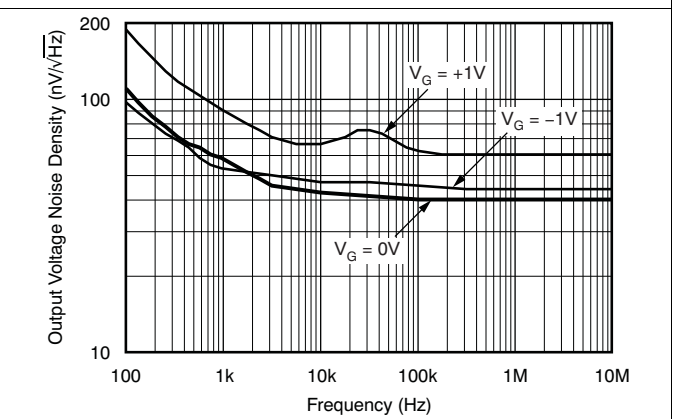

Figure 28. Output Voltage Noise Density

Typical Characteristics: $V_S = \pm 5\text{ V}$, $A_{VMAX} = 10\text{ V/V}$ (continued)

At $T_A = 25^\circ\text{C}$, $R_L = 100\ \Omega$, $R_F = 402\ \Omega$, $R_G = 80\ \Omega$, $V_G = 1\text{ V}$, and V_{IN} = single-ended input on $+V_{IN}$ with $-V_{IN}$ at ground, unless otherwise noted.

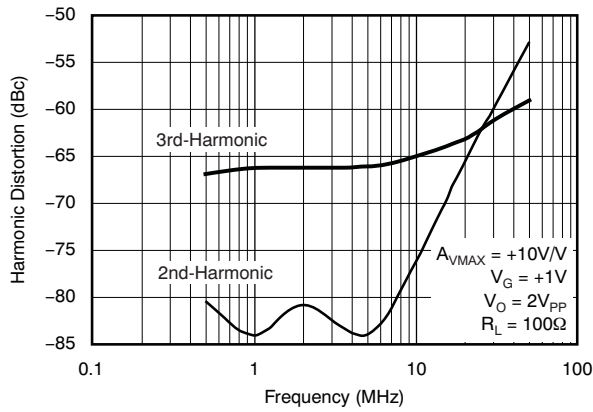

Figure 29. Harmonic Distortion vs Frequency

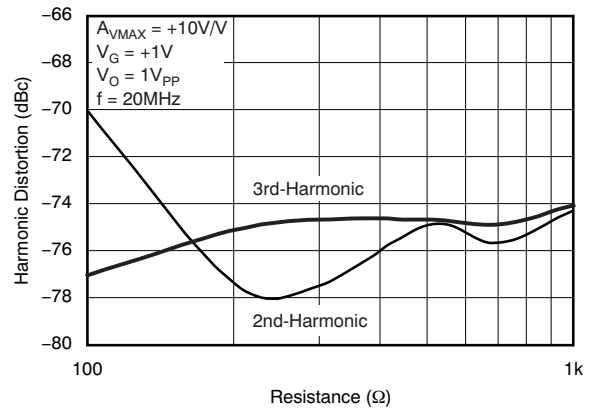

Figure 30. Harmonic Distortion vs Load Resistance

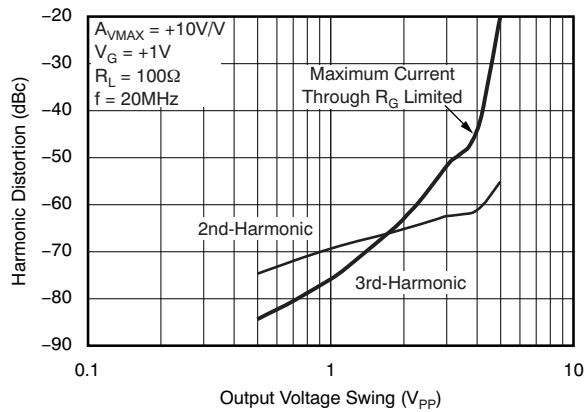

Figure 31. Harmonic Distortion vs Output Voltage

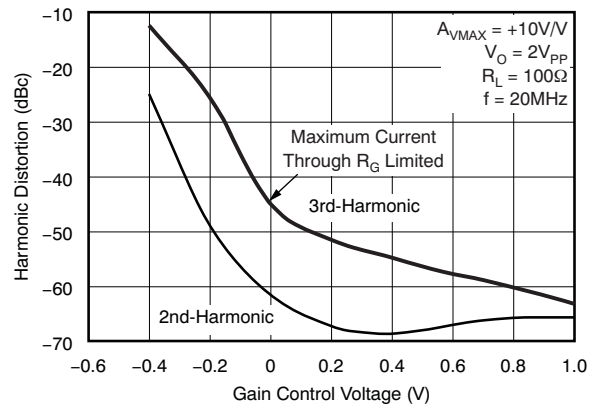

Figure 32. Harmonic Distortion vs Gain Control Voltage

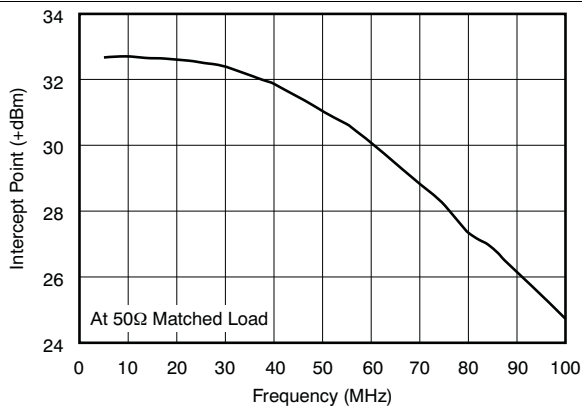

Figure 33. Two-Tone, 3rd-Order Intermodulation Intercept

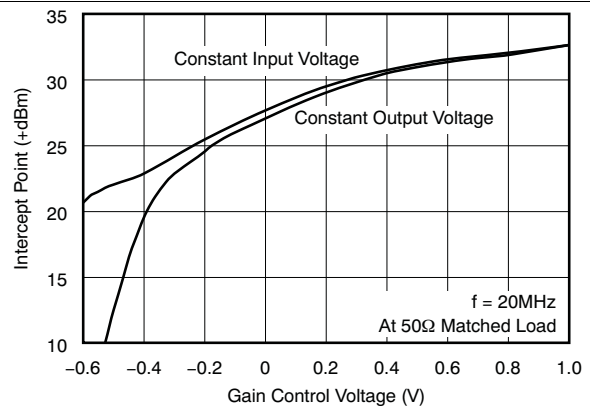

Figure 34. Two-Tone, 3rd-Order Intermodulation Intercept vs Gain Control Voltage

Typical Characteristics: $V_S = \pm 5\text{ V}$, $A_{VMAX} = 10\text{ V/V}$ (continued)

At $T_A = 25^\circ\text{C}$, $R_L = 100\ \Omega$, $R_F = 402\ \Omega$, $R_G = 80\ \Omega$, $V_G = 1\text{ V}$, and V_{IN} = single-ended input on $+V_{IN}$ with $-V_{IN}$ at ground, unless otherwise noted.

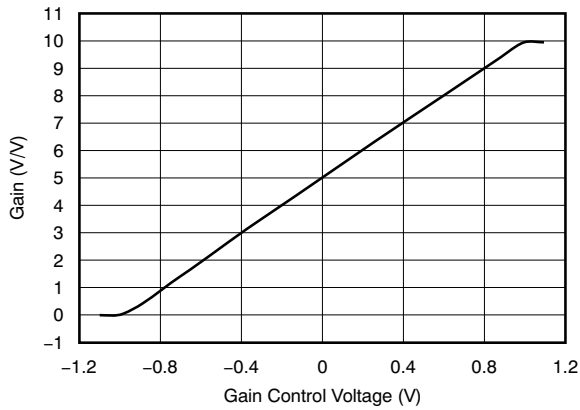

Figure 35. Gain vs Gain Control Voltage

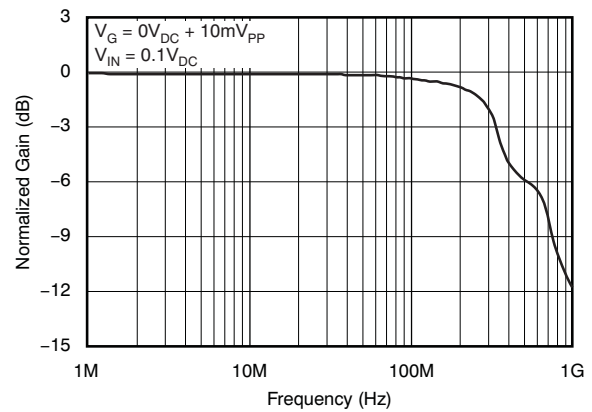

Figure 36. Gain Control Frequency Response

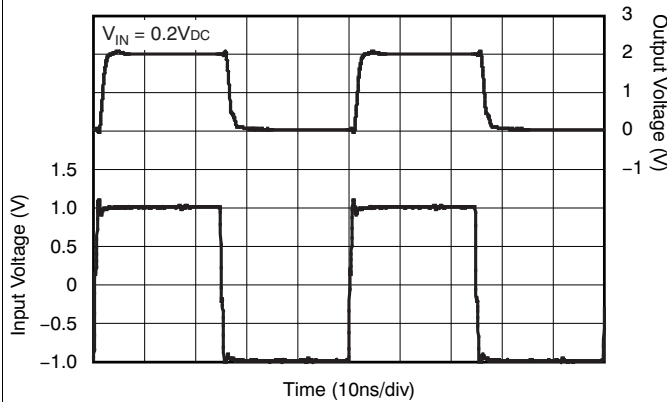

Figure 37. Gain Control Pulse Response

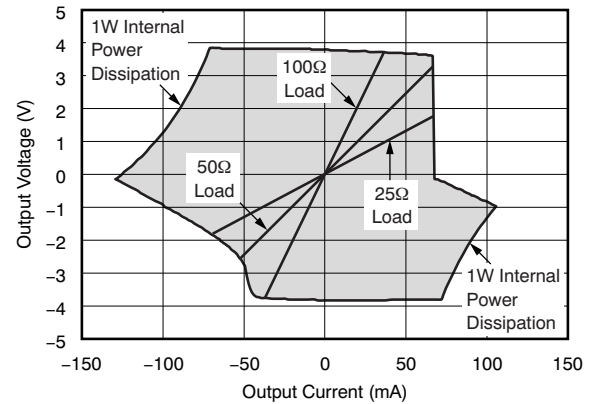

Figure 38. Output Voltage and Current Limitations

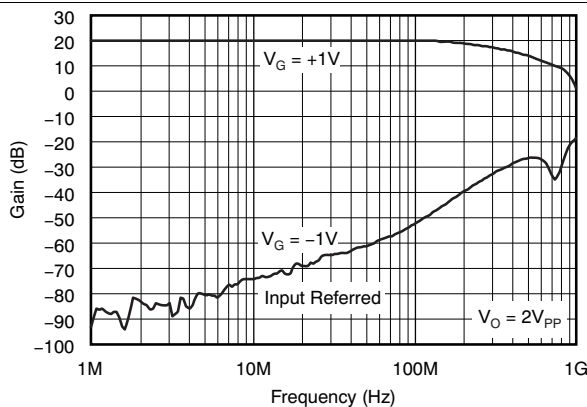

Figure 39. Fully-Attenuated Response

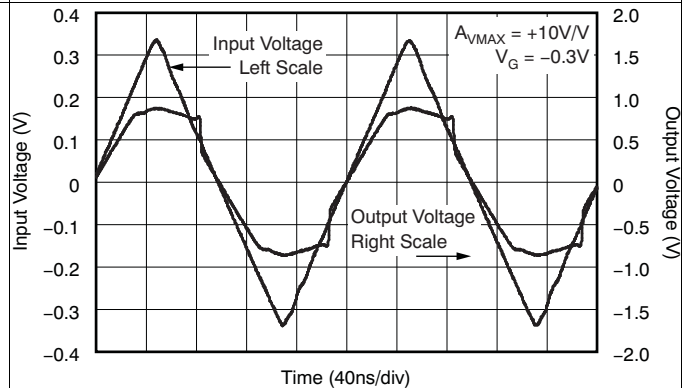
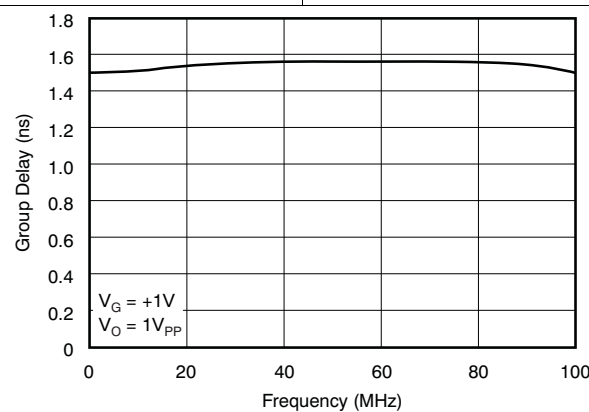
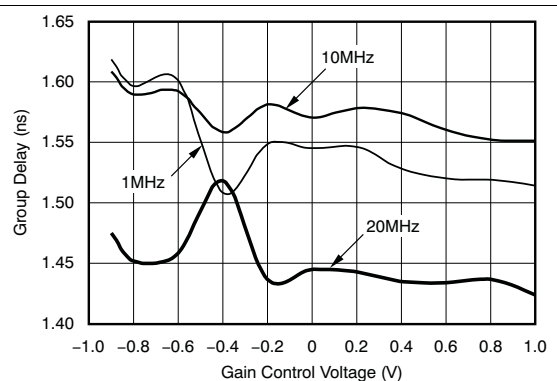
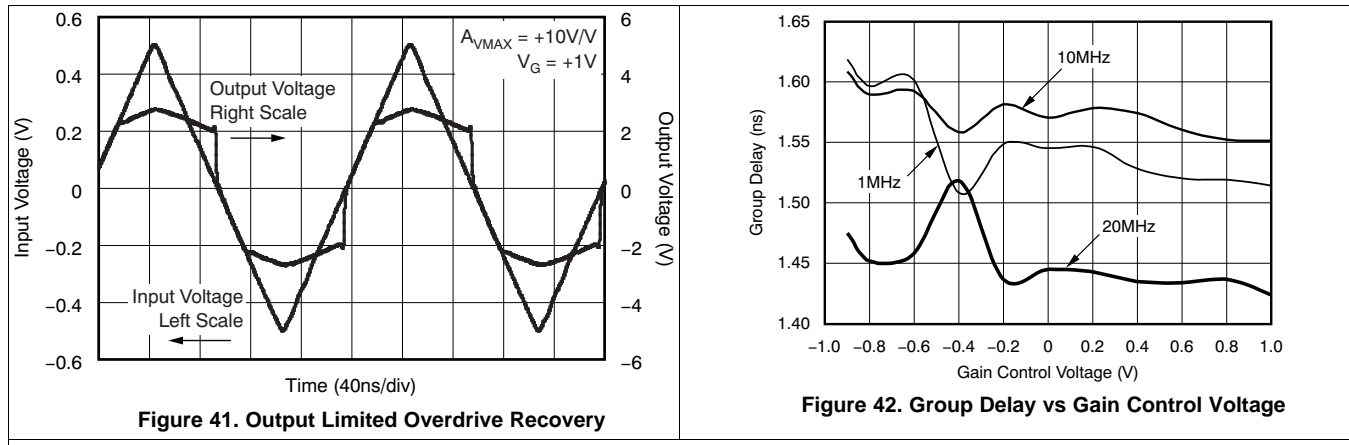

Figure 40. I_{RG} Limited Overdrive Recovery

Typical Characteristics: $V_S = \pm 5\text{ V}$, $A_{V_{MAX}} = 10\text{ V/V}$ (continued)

At $T_A = 25^\circ\text{C}$, $R_L = 100\ \Omega$, $R_F = 402\ \Omega$, $R_G = 80\ \Omega$, $V_G = 1\text{ V}$, and V_{IN} = single-ended input on $+V_{IN}$ with $-V_{IN}$ at ground, unless otherwise noted.



7.8 Typical Characteristics: $V_S = \pm 5\text{ V}$, $A_{VMAX} = 40\text{ V/V}$

At $T_A = 25^\circ\text{C}$, $R_L = 100\ \Omega$, $R_F = 402\ \Omega$, $R_G = 18\ \Omega$, $V_G = 1\text{ V}$, V_{IN} = single-ended input on $+V_{IN}$ with $-V_{IN}$ at ground, and SO-14 package, unless otherwise noted.

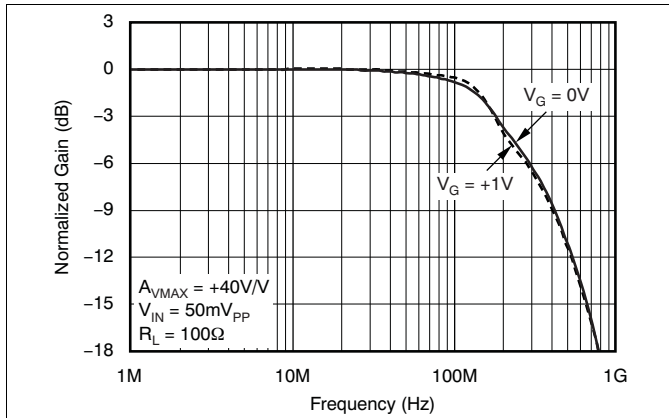

Figure 44. Small-Signal Frequency Response

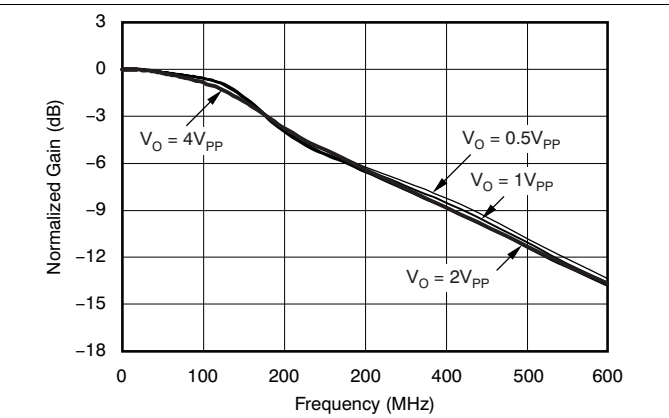

Figure 45. Large-Signal Frequency Response

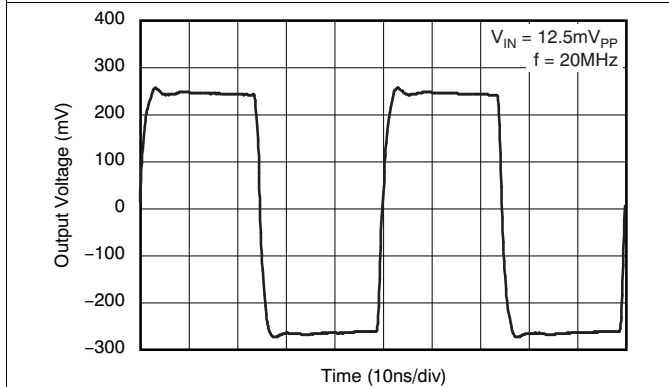

Figure 46. Small-Signal Pulse Response

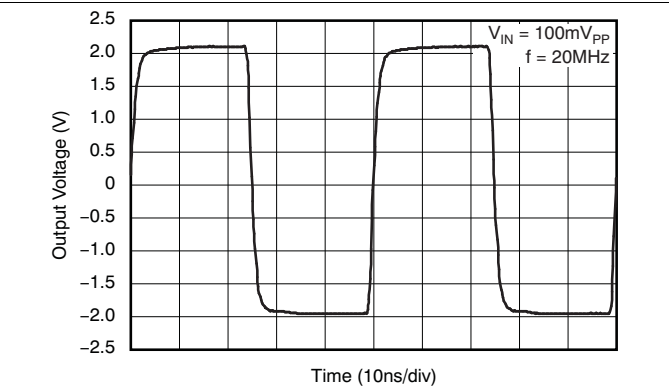

Figure 47. Large-Signal Pulse Response

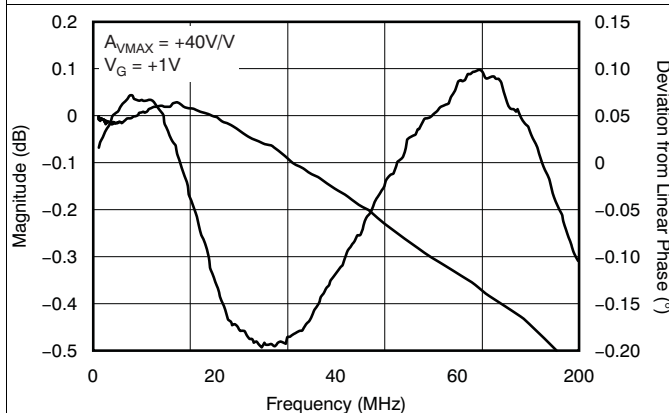

Figure 48. Gain Flatness, Deviation from Linear Phase

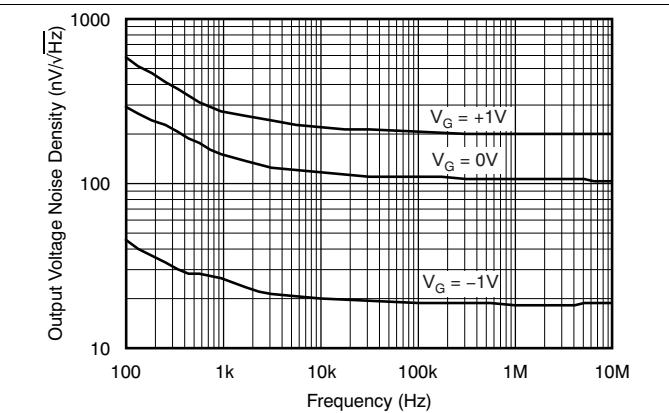

Figure 49. Output Voltage Noise Density

Typical Characteristics: $V_S = \pm 5\text{ V}$, $A_{VMAX} = 40\text{ V/V}$ (continued)

At $T_A = 25^\circ\text{C}$, $R_L = 100\ \Omega$, $R_F = 402\ \Omega$, $R_G = 18\ \Omega$, $V_G = 1\text{ V}$, V_{IN} = single-ended input on $+V_{IN}$ with $-V_{IN}$ at ground, and SO-14 package, unless otherwise noted.

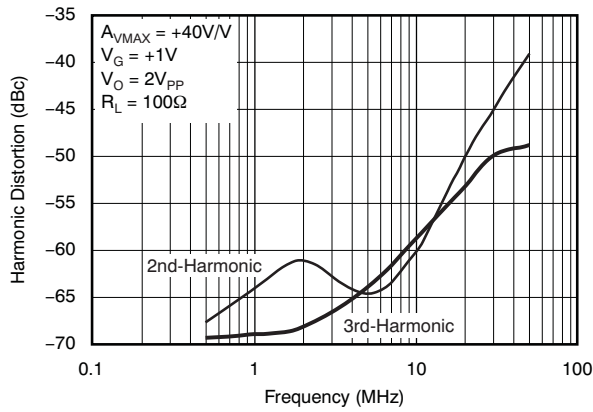

Figure 50. Harmonic Distortion vs Frequency

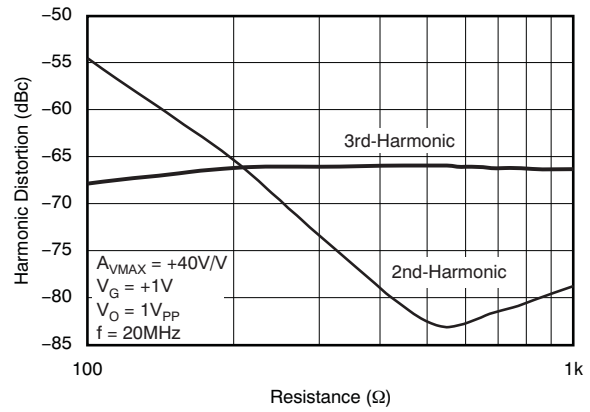

Figure 51. Harmonic Distortion vs Load Resistance

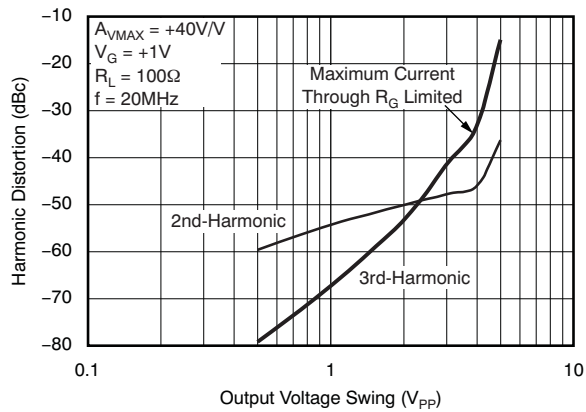

Figure 52. Harmonic Distortion vs Output Voltage

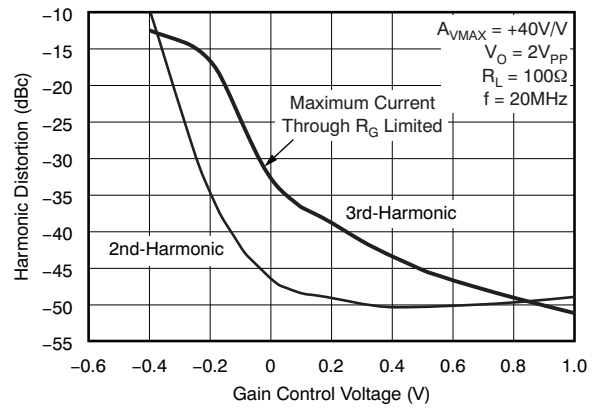

Figure 53. Harmonic Distortion vs Gain Control Voltage

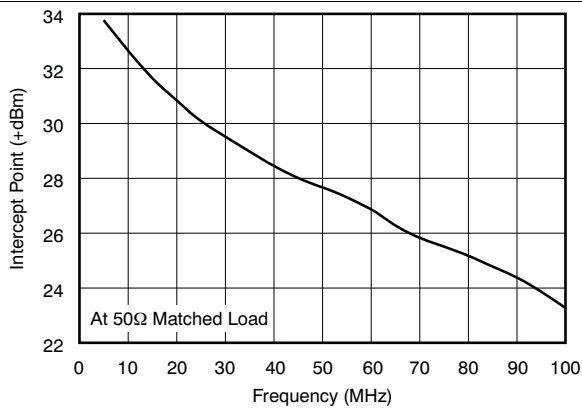

Figure 54. Two-Tone, 3rd-Order Intermodulation Intercept

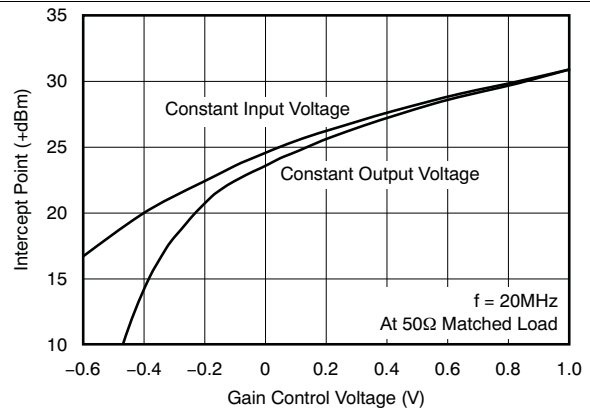

Figure 55. Two-Tone, 3rd-Order Intermodulation Intercept vs Gain Control Voltage

Typical Characteristics: $V_S = \pm 5\text{ V}$, $A_{VMAX} = 40\text{ V/V}$ (continued)

At $T_A = 25^\circ\text{C}$, $R_L = 100\ \Omega$, $R_F = 402\ \Omega$, $R_G = 18\ \Omega$, $V_G = 1\text{ V}$, V_{IN} = single-ended input on $+V_{IN}$ with $-V_{IN}$ at ground, and SO-14 package, unless otherwise noted.

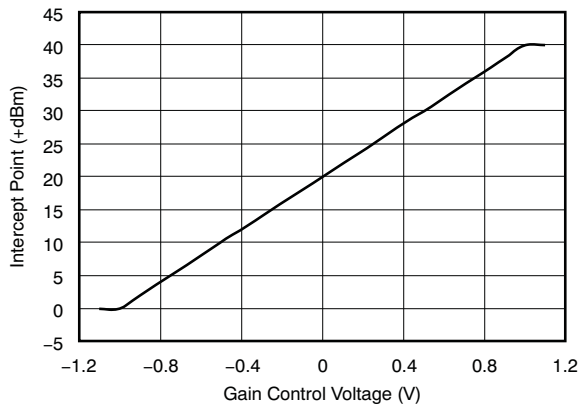

Figure 56. Gain vs Gain Control Voltage

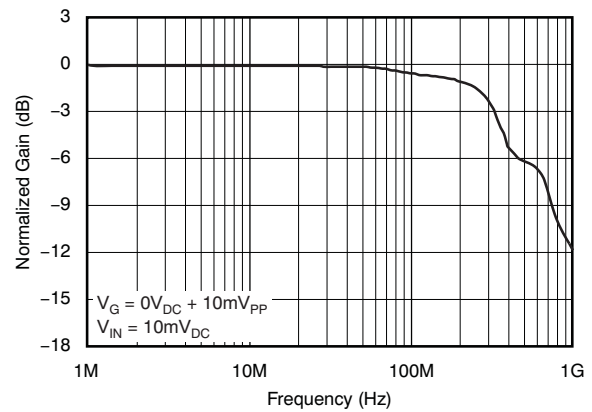

Figure 57. Gain Control Frequency Response

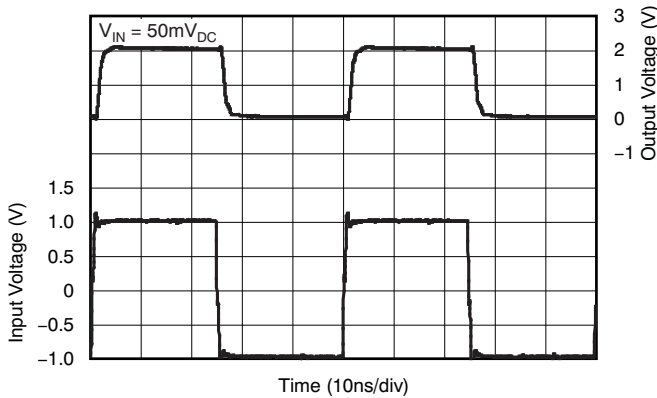

Figure 58. Gain Control Pulse Response

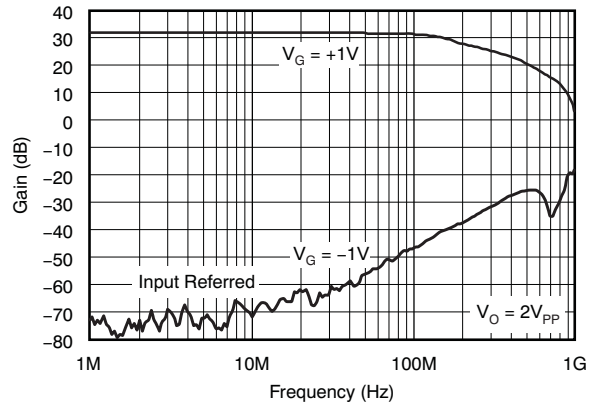

Figure 59. Fully Attenuated Response

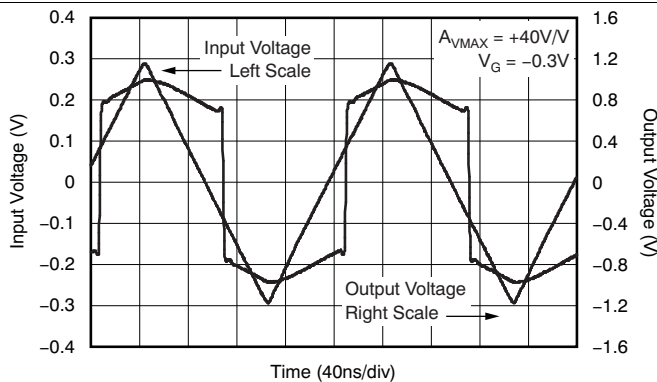

Figure 60. I_{RG} Limited Overdrive Recovery

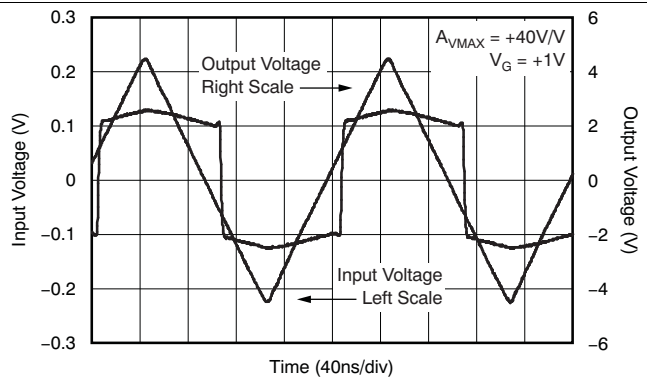
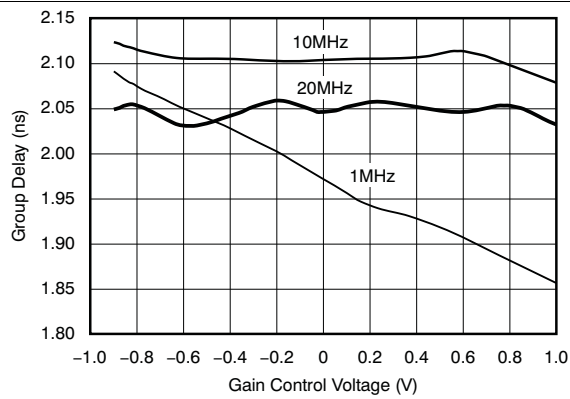
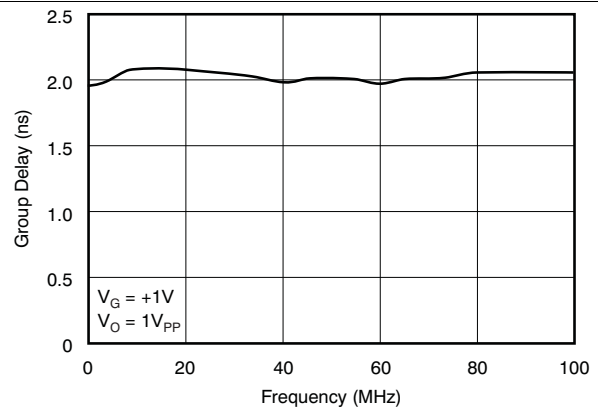

Figure 61. Output Limited Overdrive Recovery

Typical Characteristics: $V_S = \pm 5\text{ V}$, $A_{V_{MAX}} = 40\text{ V/V}$ (continued)

At $T_A = 25^\circ\text{C}$, $R_L = 100\ \Omega$, $R_F = 402\ \Omega$, $R_G = 18\ \Omega$, $V_G = 1\text{ V}$, V_{IN} = single-ended input on $+V_{IN}$ with $-V_{IN}$ at ground, and SO-14 package, unless otherwise noted.

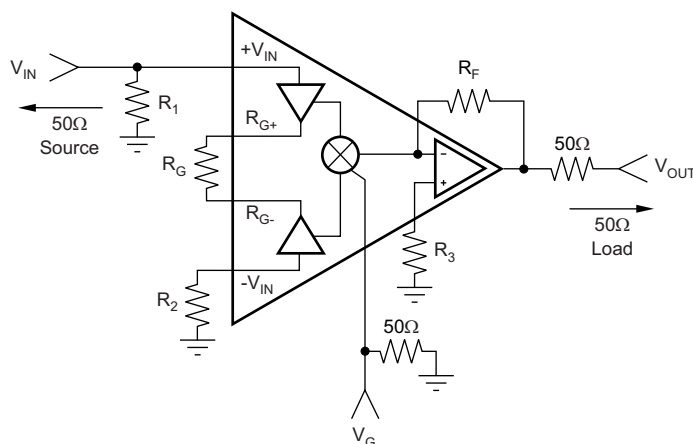

Figure 62. Group Delay vs Gain Control Voltage

Figure 63. Group Delay vs Frequency

8 Detailed Description

8.1 Overview

The VCA824 is a voltage controlled variable gain amplifier with differential inputs and a single ended output. The maximum gain is set by external resistors while the gain range is controlled by an external analog voltage. The maximum gain is designed for gains of 2 V/V up to 100 V/V and the analog control allows a gain range of over 40 dB. The VCA824 Input consists of two buffers, which together create a fully symmetrical, high impedance differential input with a typical common mode rejection of 80 dB. The gain set resistor is connected between the two input buffer output pins, so that the input impedance is independent of the gain settings. The bipolar inputs have a input voltage range of 1.6 and -2.1 V on ± 5 V supplies. The amplifier maximum gain is set by external resistors, but the internal gain control circuit is controlled by a continuously variable, analog voltage. The gain control is a multiplier stage which is linear in V/V. The gain control input pin operates over a voltage range of -1 V to 1 V. The VCA824 contains a high-speed, high-current output buffer. The output stage can typically swing ± 3.9 V and source/sink ± 90 mA. The VCA824 can be operated over a voltage range of ± 3.5 V to ± 6 V.

8.2 Functional Block Diagram



8.3 Feature Description

The VCA824 can be operated with both single ended or differential input signals. The inputs present consistently high impedance across all gain configurations. By using an analog control signal the amplifier gain is continuously variable for smooth, glitch free gain changes. With a large signal bandwidth of 320 Mhz and a slew rate of 2500 V/us the VCA824 offers linear performance over a wide range of signal amplitudes and gain settings. The low impedance/high current output buffer can drive loads ranging from low impedance transmission lines to high-impedance, switched-capacitor analog-to-digital converters. By using closely matched internal components, the VCA824 offers gain accuracy of ± 0.3 dB.

8.4 Device Functional Modes

The VCA824 functions as a differential input, single maximum gain of operation-ended output variable gain amplifier. This functional mode is enabled by applying power to the amplifier supply pins and is disabled by turning the power off. The gain is continuously variable through the analog gain control input. While the gain range is fixed, the maximum gain is set by two external components, R_f and R_g , as shown in the [Functional Block Diagram](#). The maximum gain is equal to $2x (R_f / R_g)$. This gain is achieved with a 1-V voltage on the gain adjust pin V_G . As the voltage decreases on the V_G pin, the gain decreases in a linear in dB fashion with over 40 dB of gain range from 1-V to -1 -V control voltage. As with most other differential input amplifiers, inputs can be applied to either one or both of the amplifier inputs. The amplifier gain is controlled through the gain control pin.

8.4.1 Maximum Gain Of Operation

This section describes the use of the VCA824 in a fixed-gain application in which the V_G control pin is set at $V_G = 1$ V. The tradeoffs described here are with bandwidth, gain, and output voltage range.

Device Functional Modes (continued)

In the case of an application that does not make use of the V_{GAIN} , but requires some other characteristic of the VCA824, the R_G resistor must be set such that the maximum current flowing through the resistance I_{RG} is less than ± 2.6 mA typical, or 5.2mA_{PP} as defined in [Electrical Characteristics: \$V_S = \pm 5\$ V](#), and must follow [Equation 1](#).

$$I_{RG} = \frac{V_{OUT}}{A_{VMAX} \times R_G} \quad (1)$$

As [Equation 1](#) illustrates, once the output dynamic range and maximum gain are defined, the gain resistor is set. This gain setting in turn affects the bandwidth, because in order to achieve the gain (and with a set gain element), the feedback element of the output stage amplifier is set as well. Keeping in mind that the output amplifier of the VCA824 is a current-feedback amplifier, the larger the feedback element, the lower the bandwidth because the feedback resistor is the compensation element.

Limiting the discussion to the input voltage only and ignoring the output voltage and gain, [Equation 2](#) illustrates the tradeoff between the input voltage and the current flowing through the gain resistor.

8.4.2 Output Current And Voltage

The VCA824 provides output voltage and current capabilities that are unsurpassed in a low-cost monolithic VCA. Under no-load conditions at 25°C , the output voltage typically swings closer than 1 V to either supply rails; the 25°C swing limit is within 1.2 V of either rails. Into a 15- Ω load (the minimum tested load), the VCA824 device is tested to deliver more than ± 160 mA.

The specifications described above, though familiar in the industry, consider voltage and current limits separately. In many applications, it is the voltage \times current, or *V-I product*, that is more relevant to circuit operation (See [Figure 38](#)). The X- and Y-axes of this graph show the zero-voltage output current limit and the zero-current output voltage limit, respectively. The four quadrants give a more detailed view of the VCA824 output drive capabilities, noting that the graph is bounded by a *Safe Operating Area* of 1-W maximum internal power dissipation. Superimposing resistor load lines onto the plot shows that the VCA824 can drive ± 2.5 V into 25- Ω or ± 3.5 V into 50- Ω without exceeding the output capabilities or the 1-W dissipation limit. A 100- Ω load line (the standard test circuit load) shows the full ± 3.9 -V output swing capability, as shown in [Typical Characteristics](#).

The minimum specified output voltage and current overtemperature are set by worst-case simulations at the cold temperature extreme. Only at cold startup do the output current and voltage decrease to the numbers shown in [Electrical Characteristic](#). As the output transistors deliver power, the respective junction temperatures increase, thereby increasing the available output voltage swing and output current.

In steady-state operation, the available output voltage and current are always greater than the temperature shown in the overtemperature specifications because the output stage junction temperatures are higher than the specified operating ambient.

8.4.3 Input Voltage Dynamic Range

The VCA824 has a input dynamic range limited to 1.6 V and -2.1 V. Increasing the input voltage dynamic range can be done by using an attenuator network on the input. If the VCA824 is trying to regulate the amplitude at the output, such as in an AGC application, the input voltage dynamic range is directly proportional to [Equation 2](#).

$$V_{IN(PP)} = R_G \times I_{RG(PP)} \quad (2)$$

As such, for unity-gain or under-attenuated conditions, the input voltage must be limited to the CMIR of ± 1.6 V ($3.2 V_{PP}$) and the current (I_{RQ}) must flow through the gain resistor, ± 2.6 mA (5.2mA_{PP}). This configuration sets a minimum value for R_E such that the gain resistor must be greater than [Equation 3](#).

$$R_{GMIN} = \frac{3.2V_{PP}}{5.2\text{mA}_{PP}} = 615.4\Omega \quad (3)$$

Values lower than 615.4 Ω are gain elements that result in reduced input range, as the dynamic input range is limited by the current flowing through the gain resistor R_G (I_{RG}). If the I_{RG} current limits the performance of the circuit, the input stage of the VCA824 goes into overdrive, resulting in limited output voltage range. Such I_{RG} -limited overdrive conditions are shown in [Figure 40](#) for the gain of 10V/V and [Figure 60](#) for the gain of 40 V/V.

Device Functional Modes (continued)

8.4.4 Output Voltage Dynamic Range

With its large output current capability and its wide output voltage swing of ± 3.9 V typical on 100- Ω load, it is easy to forget other types of limitations that the VCA824 can encounter. For these limitations, careful analysis must be done to avoid input stage limitation: either voltage or I_{RG} current. Note that if control pin V_G varies, the gain limitation may affect other aspects of the circuit.

8.4.5 Bandwidth

The output stage of the VCA824 is a wideband current-feedback amplifier. As such, the feedback resistance is the compensation of the last stage. Reducing the feedback element and maintaining the gain constant limits the useful range of I_{RG} , and therefore, reduces the gain adjust range. For a given gain, reducing the gain element limits the maximum achievable output voltage swing.

8.4.6 Offset Adjustment

As a result of the internal architecture used on the VCA824, the output offset voltage originates from the output stage and from the input stage and multiplier core. Figure 67 shows how to compensate both sources of the output offset voltage. Use this procedure to compensate the output offset voltage: starting with the output stage compensation, set $V_G = -1$ V to eliminate all offset contribution of the input stage and multiplier core. Adjust the output stage offset compensation potentiometer. Finally, set $V_G = 1$ V to the maximum gain and adjust the input stage and multiplier core potentiometer. This procedure effectively eliminates all offset contribution at the maximum gain. Because adjusting the gain modifies the contribution of the input stage and the multiplier core, some residual output offset voltage remains.

8.4.7 Noise

The VCA824 offers 6 nV/ $\sqrt{\text{Hz}}$ input-referred voltage noise density at a gain of 10 V/V and 2.6-pA/ $\sqrt{\text{Hz}}$ input-referred current noise density. The input-referred voltage noise density considers that all noise terms (except the input current noise but including the thermal noise of both the feedback resistor and the gain resistor) are expressed as one term.

This model is formulated in Equation 4 and Figure 68.

$$e_o = A_{V_{MAX}} \times \sqrt{2 \times (R_s \times i_n)^2 + e_n^2 + 2 \times 4kTR_s} \quad (4)$$

A more complete model is shown in Figure 69. For additional information on this model and the actual modeled noise terms, please contact the High-Speed Product Application Support team at www.ti.com.

8.4.8 Input and ESD Protection

The VCA824 is built using a very high-speed complementary bipolar process. The internal junction breakdown voltages are relatively low for these very small geometry devices. These breakdowns are reflected in the [Absolute Maximum Ratings](#).

All pins on the VCA824 are internally protected from ESD by means of a pair of back-to-back reverse-biased diodes to either power supply, as shown in Figure 64. These diodes begin to conduct when the pin voltage exceeds either power supply by about 0.7 V. This situation can occur with loss of the amplifier power supplies while a signal source is still present. The diodes can typically withstand a continuous current of 30 mA without destruction. To ensure long-term reliability, however, diode current should be externally limited to 10 mA whenever possible.

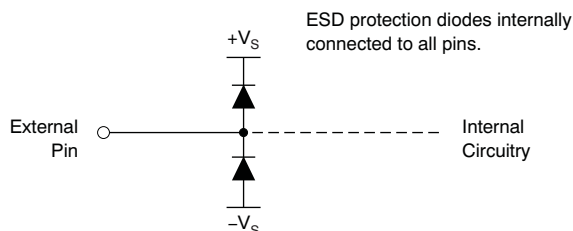

Figure 64. Internal ESD Protection

9 Application and Implementation

NOTE

Information in the following applications sections is not part of the TI component specification, and TI does not warrant its accuracy or completeness. TI's customers are responsible for determining suitability of components for their purposes. Customers should validate and test their design implementation to confirm system functionality.

9.1 Application Information

9.1.1 Difference Amplifier

Because both inputs of the VCA824 are high-impedance, a difference amplifier can be implemented without any major problem. Figure 65 shows this implementation. This circuit provides excellent common-mode rejection ratio (CMRR) as long as the input is within the CMRR range of -2.1 V to 1.6 V . Note that this circuit does not make use of the gain control pin, V_G . Also, it is recommended to choose R_S such that the pole formed by R_S and the parasitic input capacitance does not limit the bandwidth of the circuit. Figure 66 shows the common-mode rejection ratio for this circuit implemented in a gain of 10 V/V for $V_G = 1\text{ V}$. Note that because the gain control voltage is fixed and is normally set to 1 V , the feedback element can be reduced in order to increase the bandwidth. When reducing the feedback element, make sure that the VCA824 is not limited by common-mode input voltage, the current flowing through R_G , or any other limitation described in this data sheet.

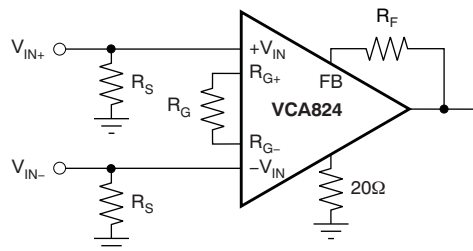

Figure 65. Difference Amplifier

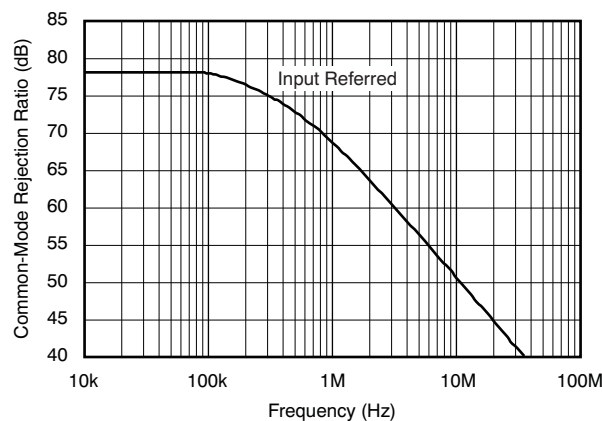

Figure 66. Common-Mode Rejection Ratio

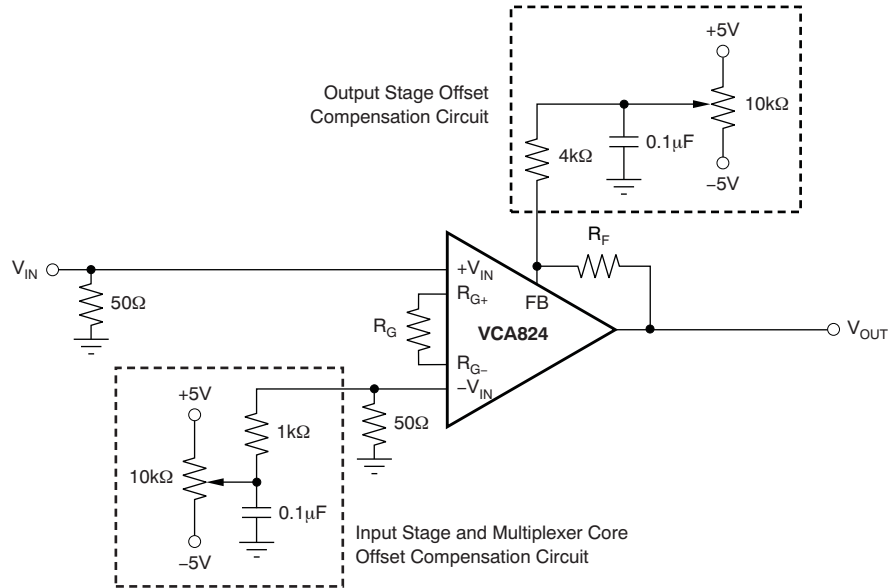

Figure 67. Adjusting the Input and Output Voltage Sources

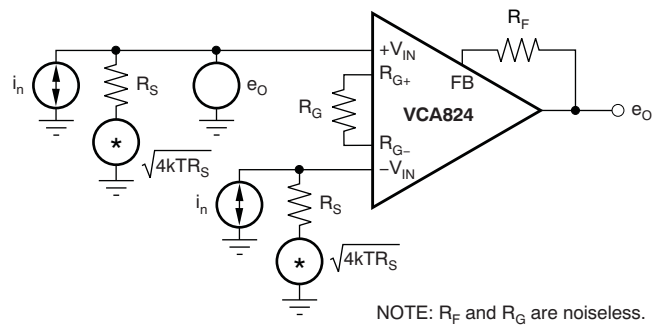

Figure 68. Simple Noise Model

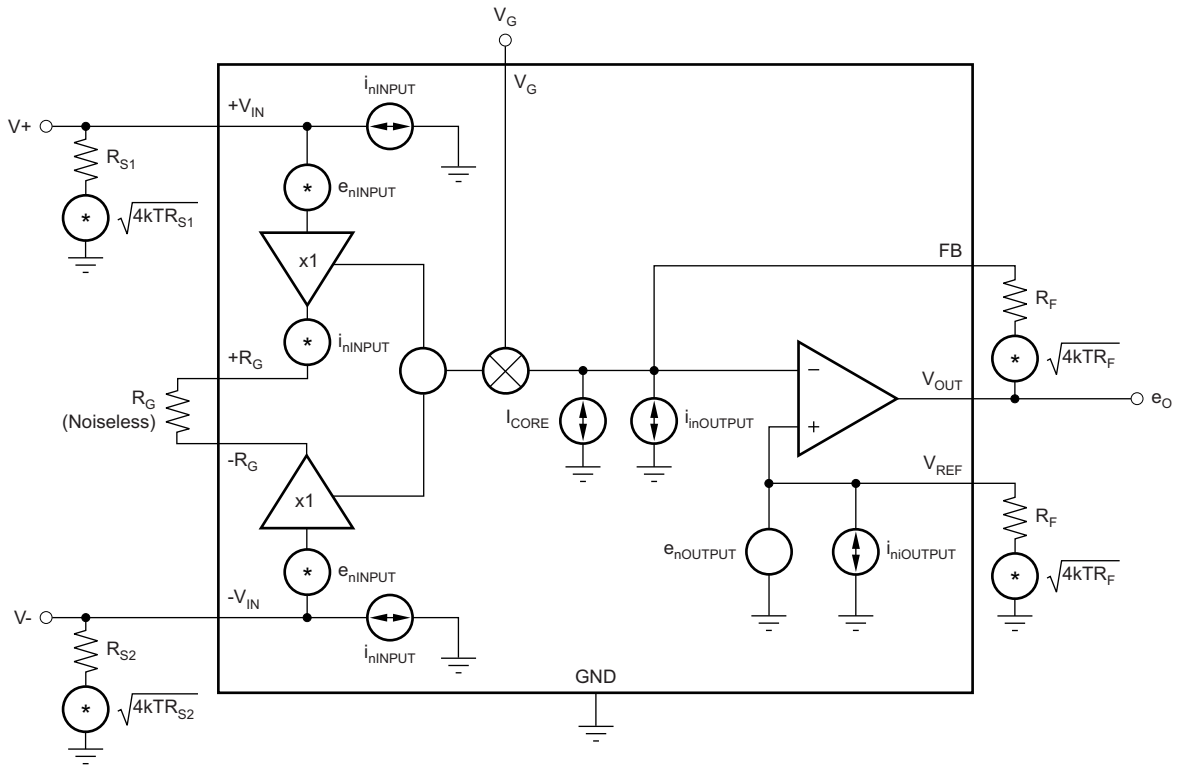

Figure 69. Full Noise Model

9.1.2 Differential Equalizer

If the application requires frequency shaping (the transition from one gain to another), the VCA824 can be used advantageously because its architecture allows the application to isolate the input from the gain setting elements. Figure 70 shows an implementation of such a configuration. The transfer function is shown in Equation 5.

$$G = 2 \times \frac{R_F}{R_G} \times \frac{1 + sR_G C_1}{1 + sR_1 C_1} \tag{5}$$

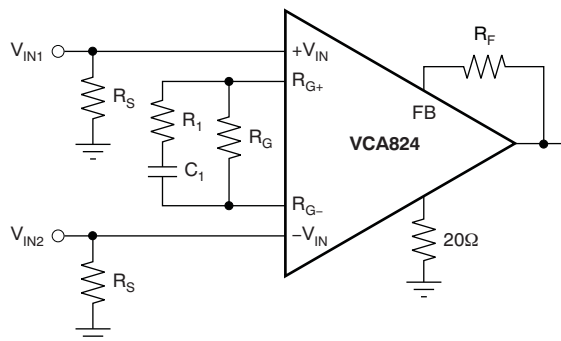

Figure 70. Differential Equalizer

This transfer function has one pole, P_1 (located at $R_G C_1$), and one zero, Z_1 (located at $R_1 C_1$). When equalizing an RC load, R_L and C_L , compensate the pole added by the load located at $R_L C_L$ with the zero Z_1 . Knowing R_L , C_L , and R_G allows the user to select C_1 as a first step and then calculate R_1 . Using $R_L = 75\text{-}\Omega$, $C_L = 100\text{pF}$ and wanting the VCA824 to operate at a gain of 2 V/V, which gives $R_F = R_G = 453\text{-k}\Omega$, allows the user to select $C_1 = 15.5\text{ pF}$ to ensure a positive value for the resistor R_1 . With all these values known, to achieve greater than 300 MHz bandwidth, R_1 can be calculated to be 20- Ω . Figure 71 shows the frequency response for both the initial, unequalized frequency response and the resulting equalized frequency response.

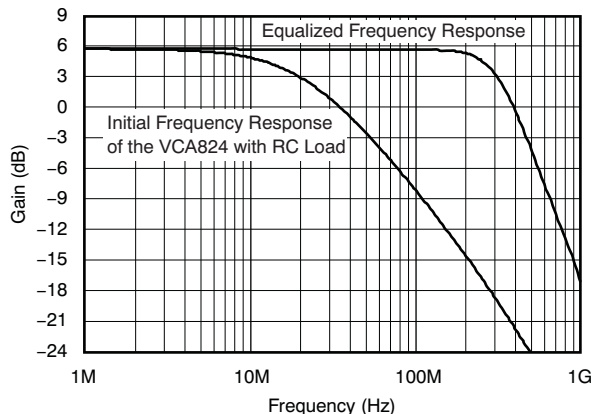

Figure 71. Differential Equalization of an RC Load

9.1.3 Differential Cable Equalizer

A differential cable equalizer can easily be implemented using the VCA824. An example of a cable equalization for 100 feet of Belden Cable 1694F is illustrated in Figure 73, with Figure 72 showing the result for this implementation. This implementation has a maximum error of 0.2 dB from DC to 70 MHz.

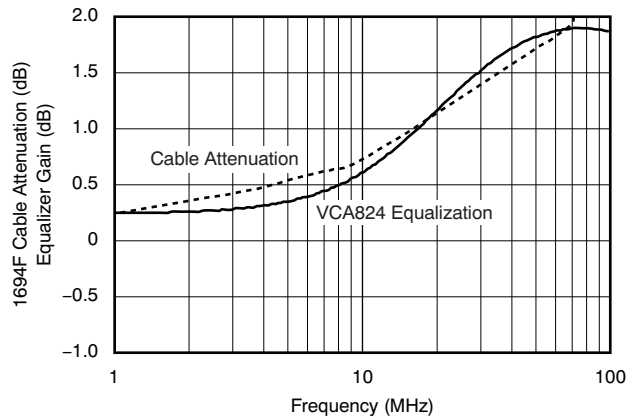

Figure 72. Cable Attenuation vs Equalizer Gain

Note that this implementation shows the cable attenuation side-by-side with the equalization in the same plot. For a given frequency, the equalization function realized with the VCA824 matches the cable attenuation. The circuit in Figure 73 is a driver circuit. To implement a receiver circuit, the signal is received differentially between the +V_{IN} and -V_{IN} inputs.

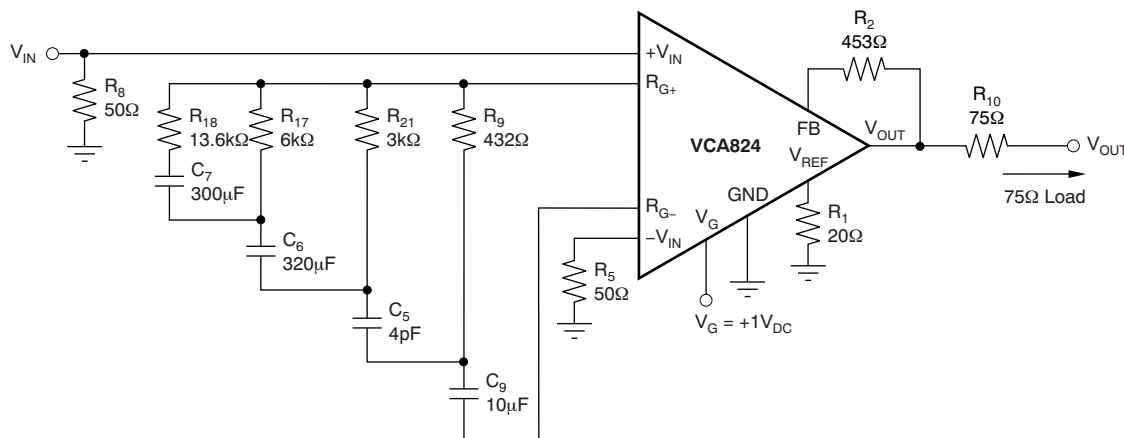

Figure 73. Differential Cable Equalizer

9.1.4 Voltage-Controlled Lowpass Filter [application sub]

In the circuit of Figure 74, the VCA824 serves as the variable-gain element of a voltage-controlled low-pass filter. This section discusses how this implementation expands the circuit voltage swing capability over that normally achieved with the equivalent multiplier implementation. The circuit control voltage, V_G, is calculated as according to the simplified relationship described in Equation 6.

$$\frac{V_{OUT}}{V_{IN}} = -\frac{R_2}{R_1} \times \frac{1}{1 + s \frac{R_2 C}{G}} \tag{6}$$

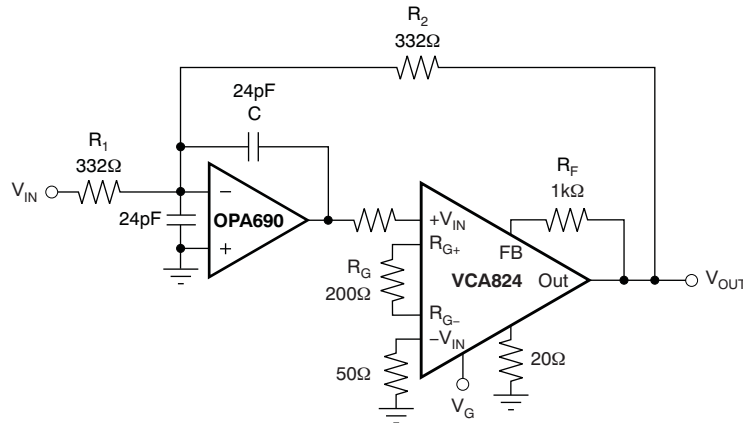

Figure 74. Voltage-Control Low-Pass Filter

The response control results from amplification of the feedback voltage applied to R_2 . First, consider the case where the VCA824 produces $G = 1V/V$. Then this circuit performs as if the amplifier were replaced by a short circuit. Visually replacing the amplifier by a short leaves a simple voltage-feedback amplifier with a feedback resistor bypassed by a capacitor. Replacing this gain with a variable gain, G , the pole can be written as shown in Equation 7.

$$f_0 = \frac{G}{2\pi R_2 C} \quad (7)$$

Because the VCA824 is most linear in the midrange, the median of the adjustable pole should be set at $V_G = 0V$ (see Figure 13, Figure 33, Figure 54, and Equation 8). Selecting $R_1 = R_2 = 332\Omega$, and targeting a median frequency of 10MHz, the capacitance (C) is 24pF. Because the OPA690 was selected for the circuit of Figure 74, and in order to limit peaking in the OPA690 frequency response, a capacitor equal to C was added on the inverting mode to ground. This architecture has the effect of setting the high-frequency noise gain of the OPA690 to 2V/V, ensuring stability and providing flat frequency response.

$$-0.8V \leq V_G \leq 0.8V \quad (8)$$

Once the median frequency is set, the maximum and minimum frequencies can be determined by using $V_G = -0.8V$ and $V_G = 0.8V$ in the gain equation of Equation 9. Note that this is a first-order analysis and does not take into consideration the open-loop gain limitation of the OPA690.

$$G = 2 \times \frac{R_F}{R_G} \times \frac{V_G + 1}{2} \quad (9)$$

With the components shown, the circuit provides a linear variation of the low-pass cutoff from 2MHz to 20MHz, using $-1V \leq V_G \leq 1V$.

9.1.5 Wideband Variable Gain Amplifier Operation

The VCA824 provides an exceptional combination of high output power capability with a wideband, greater than 40dB gain adjust range, linear in V/V variable gain amplifier. The VCA824 input stage places the transconductance element between two input buffers, using the output currents as the forward signal. As the differential input voltage rises, a signal current is generated through the gain element. This current is then mirrored and gained by a factor of two before reaching the multiplier. The other input of the multiplier is the voltage gain control pin, V_G . Depending on the voltage present on V_G , up to two times the gain current is provided to the transimpedance output stage. The transimpedance output stage is a current-feedback amplifier providing high output current capability and high slew rate, 2500 V/ μ s. This exceptional full-power performance comes at the price of relatively high quiescent current (36.5 mA), but low input voltage noise for this type of architecture (6 nV/ \sqrt{Hz}).

Figure 75 shows the dc-coupled, gain of 10 V/V, dual power-supply circuit used as the basis of *Electrical Characteristics- $V_S = \pm 5$ V*, *Electrical Characteristics: $V_S = \pm 5$ V* and *Typical Characteristics*. For test purposes, the input impedance is set to 50- Ω with a resistor to ground and the output impedance is set to 50- Ω with a series output resistor. Voltage swings reported in *Electrical Characteristics- $V_S = \pm 5$ V* are taken directly at the input and output pins, while output power (dBm) is at the matched 50- Ω load. For the circuit in Figure 75, the total effective load is 100- Ω \parallel 1-k Ω . Note that for the 14-pin, SOIC package, there is a voltage reference pin, V_{REF} (pin 9). For the 14-pin SOIC package, this pin must be connected to ground through a 20- Ω resistor to avoid possible oscillations of the output stage. In the 10-pin, MSOP package, this pin is internally connected and does not require such precaution. An X2Y[®] capacitor has been used for power-supply bypassing. The combination of low inductance, high resonance frequency, and integration of three capacitors in one package (two capacitors to ground and one across the supplies) enables the VCA824 to achieve the low second-harmonic distortion reported in *Electrical Characteristics- $V_S = \pm 5$ V*.

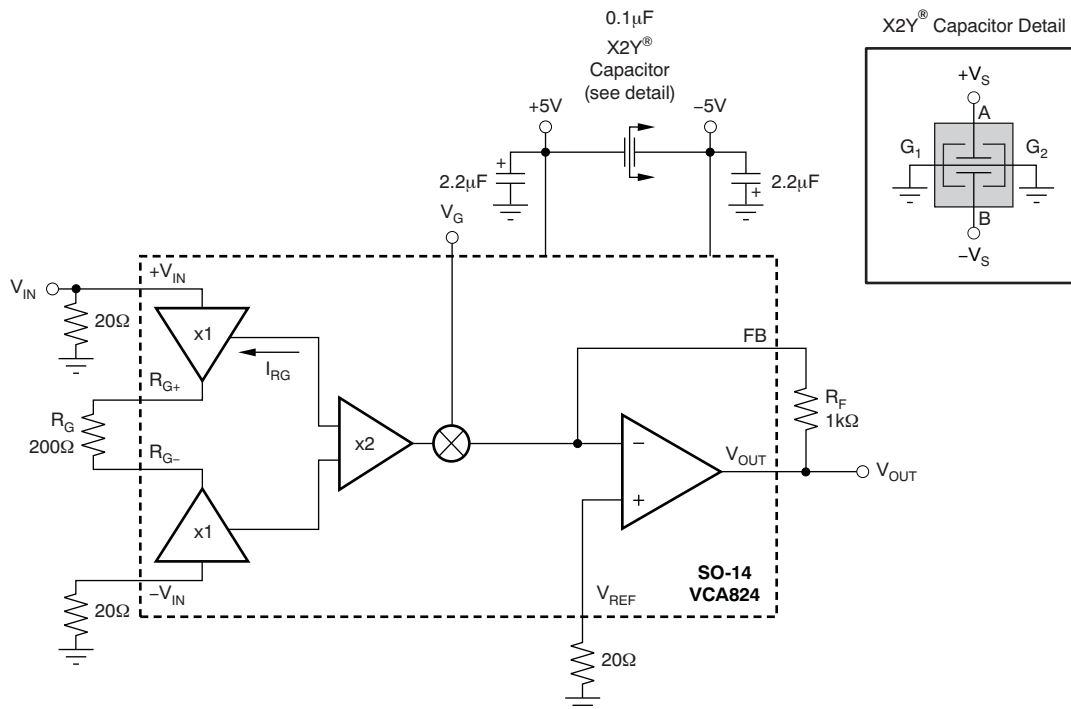

Figure 75. DC-Coupled, $A_{VMAX} = 10$ V/V, Bipolar Supply Specification and Test Circuit

9.2 Typical Application

A four-quadrant multiplier can easily be implemented using the VCA824. By placing a resistor between FB and V_{IN} , the transfer function depends upon both V_{IN} and V_G , as shown in Equation 10.

$$V_{OUT} = \frac{R_F}{R_G} \times V_G \times V_{IN} + \left[\frac{R_F}{R_G} - \frac{R_F}{R_1} \right] \times V_{IN} \quad (10)$$

Setting R_1 to equal R_G , the term that depends only on V_{IN} drops out of the equation, leaving only the term that depends on both V_G and V_{IN} . V_{OUT} then follows Equation 11.

$$V_{OUT} = \frac{R_F}{R_G} \times V_{IN} \times V_G \quad (11)$$

Typical Application (continued)

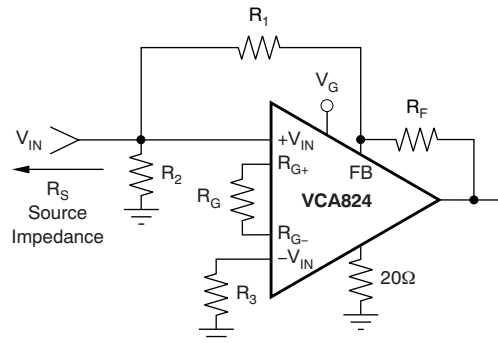

Figure 76. Four-Quadrant Multiplier Circuit

Figure 77 illustrates the behavior of this circuit. Keeping the input amplitude of a 1-MHz signal constant and varying the V_G voltage (100 kHz, 2 V_{PP}) gives the modulated output voltage shown in Figure 77.

9.2.1 Design Requirements

A multiplier requires two inputs, one for the X input and one for the Y input. The output of the multiplier circuit is in the form of $V_{out} = aVin1 \times bVin2$: where a and b are real numbers and should not be negative. For four quadrant operation both positive and negative inputs must be supported on the X and Y inputs.

A four-quadrant multiplier can easily be implemented using the VCA824. By placing a resistor between FB and VIN, the transfer function depends upon both VIN and V_G , as shown in Equation 10

9.2.2 Detailed Design Procedure

Setting R1 to equal RG, the term that depends only on VIN drops out of the equation, leaving only the term that depends on both VG and VIN. VOUT then follows Equation 11.

The behavior of this circuit is illustrated in Figure 77. Keeping the input amplitude of a 1MHz signal constant and varying the VG voltage (100 kHz, 2 VPP) gives the modulated output voltage shown in Figure 77.

9.2.3 Application Curve

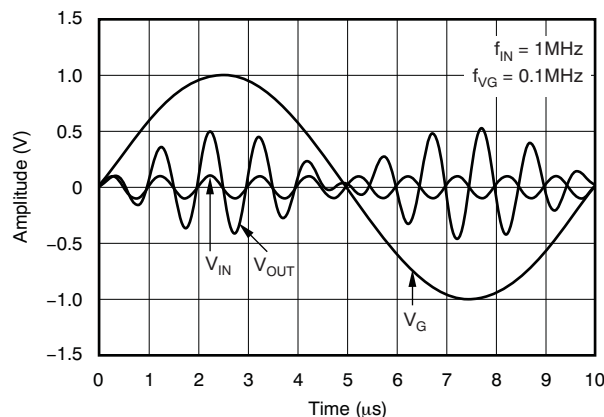

Figure 77. Modulated Output Signal of the 4-Quadrant Multiplier Circuit

10 Power Supply Recommendations

High-speed amplifiers require low inductance power supply traces and low ESR bypass capacitors. When possible both power and ground planes should be used in the printed circuit board design and the power plane should be adjacent to the ground plane in the board stack-up. The power supply voltage should be centered on the desired amplifier output voltage, so for ground referenced output signals, split supplies are required. The power supply voltage should be from 7-V to 12-V.

11 Layout

11.1 Layout Guidelines

Achieving optimum performance with a high-frequency amplifier such as the VCA824 requires careful attention to printed circuit board (PCB) layout parasitics and external component types. Recommendations to optimize performance include:

- a. **Minimize parasitic capacitance** to any AC ground for all of the signal I/O pins. This recommendation includes the ground pin (pin 2). Parasitic capacitance on the output can cause instability: on both the inverting input and the noninverting input, it can react with the source impedance to cause unintentional band limiting. To reduce unwanted capacitance, a window around the signal I/O pins should be opened in all of the ground and power planes around those pins. Otherwise, ground and power planes should be unbroken elsewhere on the board. Place a small series resistance (greater than 25- Ω) with the input pin connected to ground to help decouple package parasitics.
- b. **Minimize the distance** (less than 0.25") from the power-supply pins to high-frequency 0.1- μ F decoupling capacitors. At the device pins, the ground and power plane layout should not be in close proximity to the signal I/O pins. Avoid narrow power and ground traces to minimize inductance between the pins and the decoupling capacitors. The power-supply connections should always be decoupled with these capacitors. Larger (2.2- μ F to 6.8- μ F) decoupling capacitors, effective at lower frequencies, should also be used on the main supply pins. These capacitors may be placed somewhat farther from the device and may be shared among several devices in the same area of the PCB.
- c. **Careful selection and placement** of external components preserve the high-frequency performance of the VCA824. Resistors should be a very low reactance type. Surface-mount resistors work best and allow a tighter overall layout. Metal-film and carbon composition, axially-leaded resistors can also provide good high-frequency performance. Again, keep the leads and PCB trace length as short as possible. Never use wire-wound type resistors in a high-frequency application. Because the output pin is the most sensitive to parasitic capacitance, always position the series output resistor, if any, as close as possible to the output pin. Other network components, such as inverting or noninverting input termination resistors, should also be placed close to the package.
- d. **Connections to other wideband devices** on the board may be made with short direct traces or through onboard transmission lines. For short connections, consider the trace and the input to the next device as a lumped capacitive load. Relatively wide traces (50 mils to 100 mils, or 1.27 mm to 2.54 mm) should be used, preferably with ground and power planes opened up around them.
- e. **Socketing a high-speed part like the VCA824 device is not recommended.** The additional lead length and pin-to-pin capacitance introduced by the socket can create an extremely troublesome parasitic network, which can make it almost impossible to achieve a smooth, stable frequency response. Best results are obtained by soldering the VCA824 device onto the board.

11.2 Layout Example

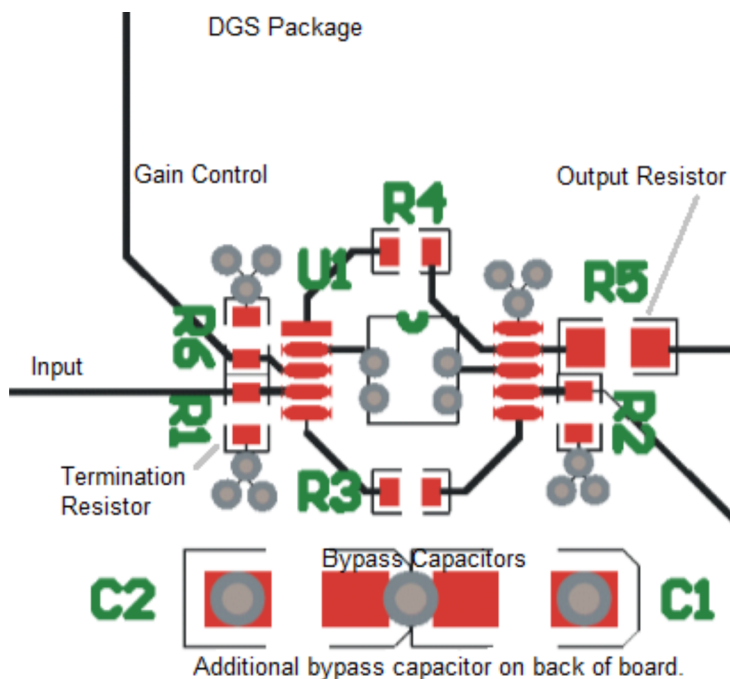

Figure 78. Layout Recommendation

11.3 Thermal Considerations

The VCA824 does not require heatsinking or airflow in most applications. The maximum desired junction temperature sets the maximum allowed internal power dissipation as described in this section. In no case should the maximum junction temperature be allowed to exceed 150°C.

Operating junction temperature (T_J) is given by Equation 12:

$$T_J = T_A + P_D \times \theta_{JA} \quad (12)$$

The total internal power dissipation (P_D) is the sum of quiescent power (P_{DQ}) and additional power dissipated in the output stage (P_{DL}) to deliver load power. Quiescent power is simply the specified no-load supply current times the total supply voltage across the part. P_{DL} depends on the required output signal and load; for a grounded resistive load, however, it is at a maximum when the output is fixed at a voltage equal to one-half of either supply voltage (for equal bipolar supplies). Under this worst-case condition, $P_{DL} = V_S^2 / (4 \times R_L)$, where R_L is the resistive load.

Note that it is the power in the output stage and not in the load that determines internal power dissipation. As a worst-case example, compute the maximum T_J using a VCA824ID (SO-14 package) in the circuit of Figure 75 operating at maximum gain and at the maximum specified ambient temperature of 85°C.

$$P_D = 10V(38.5mA) + 5^2 / (4 \times 100\Omega) = 447.5mW \quad (13)$$

$$\text{Maximum } T_J = +85^\circ\text{C} + (0.449W \times 80^\circ\text{C/W}) = 120.8^\circ\text{C} \quad (14)$$

This maximum operating junction temperature is well below most system level targets. Most applications should be lower because an absolute worst-case output stage power was assumed in this calculation of $V_{CC}/2$, which is beyond the output voltage range for the VCA824.

12 Device and Documentation Support

12.1 Device Support

12.1.1 Development Support

12.1.1.1 Demonstration Boards

Two printed circuit boards (PCBs) are available to assist in the initial evaluation of circuit performance using the VCA824 in its two package options. Both of these are offered free of charge as unpopulated PCBs, delivered with a user's guide. The summary information for these fixtures is shown in [Table 1](#).

Table 1. EVM Ordering Information

PRODUCT	PACKAGE	BOARD PART NUMBER	LITERATURE REQUEST NUMBER
VCA824ID	SO-14	DEM-VCA-SO-1B	SBOU050
VCA824IDGS	MSOP-10	DEM-VCA-MSOP-1A	SBOU051

The demonstration fixtures can be requested at the Texas Instruments web site (www.ti.com) through the VCA824 product folder.

12.2 Community Resources

The following links connect to TI community resources. Linked contents are provided "AS IS" by the respective contributors. They do not constitute TI specifications and do not necessarily reflect TI's views; see TI's [Terms of Use](#).

TI E2E™ Online Community *TI's Engineer-to-Engineer (E2E) Community*. Created to foster collaboration among engineers. At e2e.ti.com, you can ask questions, share knowledge, explore ideas and help solve problems with fellow engineers.

Design Support *TI's Design Support* Quickly find helpful E2E forums along with design support tools and contact information for technical support.

12.3 Trademarks

E2E is a trademark of Texas Instruments.
X2Y is a registered trademark of X2Y Attenuators LLC.
All other trademarks are the property of their respective owners.

12.4 Electrostatic Discharge Caution



These devices have limited built-in ESD protection. The leads should be shorted together or the device placed in conductive foam during storage or handling to prevent electrostatic damage to the MOS gates.

12.5 Glossary

[SLYZ022](#) — *TI Glossary*.

This glossary lists and explains terms, acronyms, and definitions.

13 Mechanical, Packaging, and Orderable Information

The following pages include mechanical, packaging, and orderable information. This information is the most current data available for the designated devices. This data is subject to change without notice and revision of this document. For browser-based versions of this data sheet, refer to the left-hand navigation.

PACKAGING INFORMATION

Orderable Device	Status (1)	Package Type	Package Drawing	Pins	Package Qty	Eco Plan (2)	Lead/Ball Finish (6)	MSL Peak Temp (3)	Op Temp (°C)	Device Marking (4/5)	Samples
VCA824ID	ACTIVE	SOIC	D	14	50	Green (RoHS & no Sb/Br)	CU NIPDAU	Level-2-260C-1 YEAR	-40 to 85	VCA824ID	Samples
VCA824IDG4	ACTIVE	SOIC	D	14	50	Green (RoHS & no Sb/Br)	CU NIPDAU	Level-2-260C-1 YEAR	-40 to 85	VCA824ID	Samples
VCA824IDGST	ACTIVE	VSSOP	DGS	10	250	Green (RoHS & no Sb/Br)	CU NIPDAU CU NIPDAUAG	Level-2-260C-1 YEAR	-40 to 85	BOT	Samples
VCA824IDR	ACTIVE	SOIC	D	14	2500	Green (RoHS & no Sb/Br)	CU NIPDAU	Level-2-260C-1 YEAR	-40 to 85	VCA824ID	Samples

(1) The marketing status values are defined as follows:

ACTIVE: Product device recommended for new designs.

LIFEBUY: TI has announced that the device will be discontinued, and a lifetime-buy period is in effect.

NRND: Not recommended for new designs. Device is in production to support existing customers, but TI does not recommend using this part in a new design.

PREVIEW: Device has been announced but is not in production. Samples may or may not be available.

OBSELETE: TI has discontinued the production of the device.

(2) Eco Plan - The planned eco-friendly classification: Pb-Free (RoHS), Pb-Free (RoHS Exempt), or Green (RoHS & no Sb/Br) - please check <http://www.ti.com/productcontent> for the latest availability information and additional product content details.

TBD: The Pb-Free/Green conversion plan has not been defined.

Pb-Free (RoHS): TI's terms "Lead-Free" or "Pb-Free" mean semiconductor products that are compatible with the current RoHS requirements for all 6 substances, including the requirement that lead not exceed 0.1% by weight in homogeneous materials. Where designed to be soldered at high temperatures, TI Pb-Free products are suitable for use in specified lead-free processes.

Pb-Free (RoHS Exempt): This component has a RoHS exemption for either 1) lead-based flip-chip solder bumps used between the die and package, or 2) lead-based die adhesive used between the die and leadframe. The component is otherwise considered Pb-Free (RoHS compatible) as defined above.

Green (RoHS & no Sb/Br): TI defines "Green" to mean Pb-Free (RoHS compatible), and free of Bromine (Br) and Antimony (Sb) based flame retardants (Br or Sb do not exceed 0.1% by weight in homogeneous material)

(3) MSL, Peak Temp. - The Moisture Sensitivity Level rating according to the JEDEC industry standard classifications, and peak solder temperature.

(4) There may be additional marking, which relates to the logo, the lot trace code information, or the environmental category on the device.

(5) Multiple Device Markings will be inside parentheses. Only one Device Marking contained in parentheses and separated by a "~" will appear on a device. If a line is indented then it is a continuation of the previous line and the two combined represent the entire Device Marking for that device.

(6) Lead/Ball Finish - Orderable Devices may have multiple material finish options. Finish options are separated by a vertical ruled line. Lead/Ball Finish values may wrap to two lines if the finish value exceeds the maximum column width.

Important Information and Disclaimer: The information provided on this page represents TI's knowledge and belief as of the date that it is provided. TI bases its knowledge and belief on information provided by third parties, and makes no representation or warranty as to the accuracy of such information. Efforts are underway to better integrate information from third parties. TI has taken and continues to take reasonable steps to provide representative and accurate information but may not have conducted destructive testing or chemical analysis on incoming materials and chemicals. TI and TI suppliers consider certain information to be proprietary, and thus CAS numbers and other limited information may not be available for release.

In no event shall TI's liability arising out of such information exceed the total purchase price of the TI part(s) at issue in this document sold by TI to Customer on an annual basis.

TAPE AND REEL INFORMATION

QUADRANT ASSIGNMENTS FOR PIN 1 ORIENTATION IN TAPE

*All dimensions are nominal

Device	Package Type	Package Drawing	Pins	SPQ	Reel Diameter (mm)	Reel Width W1 (mm)	A0 (mm)	B0 (mm)	K0 (mm)	P1 (mm)	W (mm)	Pin1 Quadrant
VCA824IDGST	VSSOP	DGS	10	250	180.0	12.4	5.3	3.4	1.4	8.0	12.0	Q1
VCA824IDR	SOIC	D	14	2500	330.0	16.4	6.5	9.0	2.1	8.0	16.0	Q1

TAPE AND REEL BOX DIMENSIONS

*All dimensions are nominal

Device	Package Type	Package Drawing	Pins	SPQ	Length (mm)	Width (mm)	Height (mm)
VCA824IDGST	VSSOP	DGS	10	250	210.0	185.0	35.0
VCA824IDR	SOIC	D	14	2500	367.0	367.0	38.0

DGS (S-PDSO-G10)

PLASTIC SMALL-OUTLINE PACKAGE

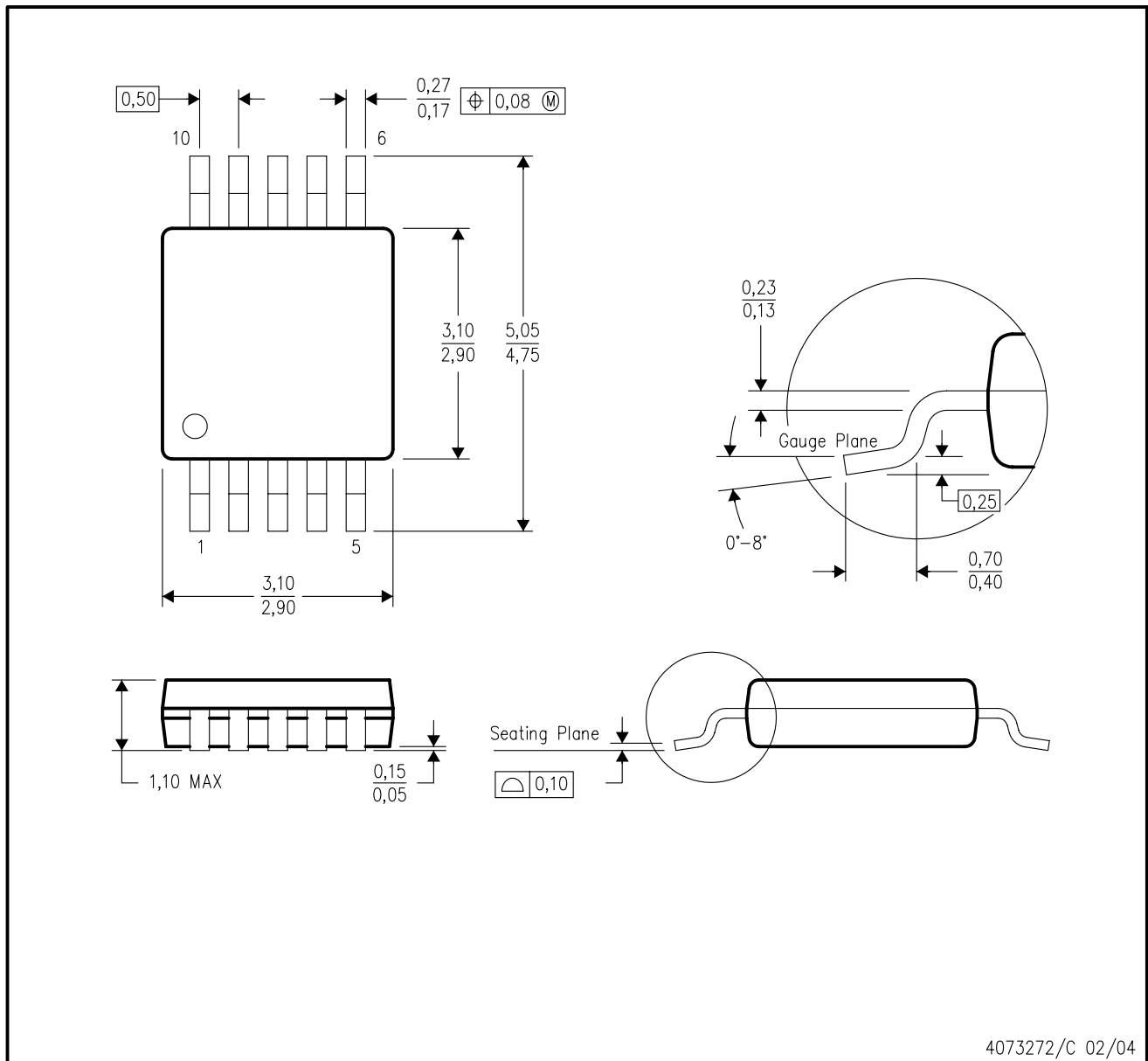

- NOTES:
- A. All linear dimensions are in millimeters.
 - B. This drawing is subject to change without notice.
 - C. Body dimensions do not include mold flash or protrusion.
 - D. Falls within JEDEC MO-187 variation BA.

DGS (S-PDSO-G10)

PLASTIC SMALL OUTLINE PACKAGE

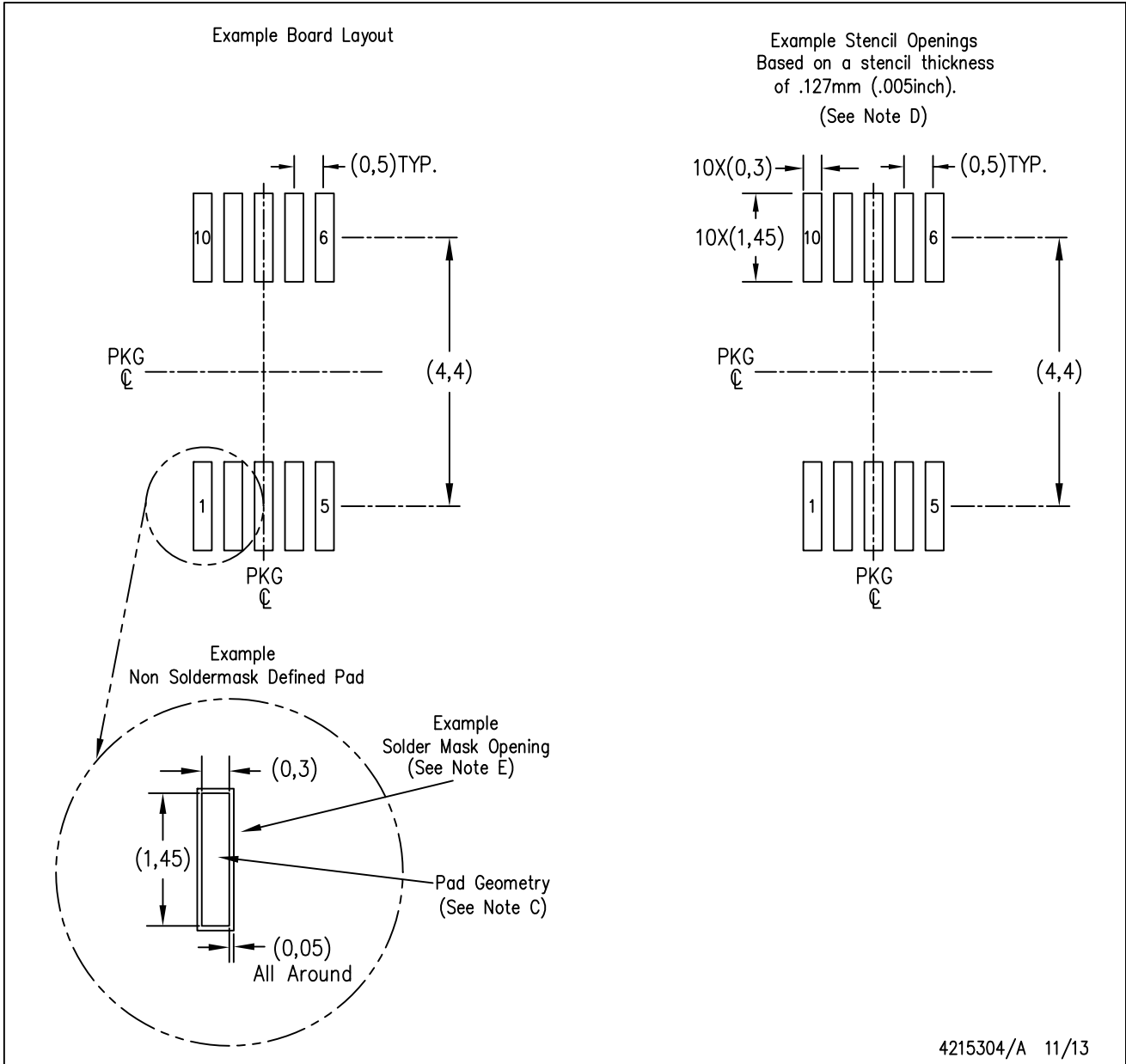

- NOTES:
- A. All linear dimensions are in millimeters.
 - B. This drawing is subject to change without notice.
 - C. Publication IPC-7351 is recommended for alternate designs.
 - D. Laser cutting apertures with trapezoidal walls and also rounding corners will offer better paste release. Customers should contact their board assembly site for stencil design recommendations. Refer to IPC-7525 for other stencil recommendations.
 - E. Customers should contact their board fabrication site for solder mask tolerances between and around signal pads.

D (R-PDSO-G14)

PLASTIC SMALL OUTLINE



- NOTES:
- A. All linear dimensions are in inches (millimeters).
 - B. This drawing is subject to change without notice.
 -  Body length does not include mold flash, protrusions, or gate burrs. Mold flash, protrusions, or gate burrs shall not exceed 0.006 (0,15) each side.
 -  Body width does not include interlead flash. Interlead flash shall not exceed 0.017 (0,43) each side.
 - E. Reference JEDEC MS-012 variation AB.

D (R-PDSO-G14)

PLASTIC SMALL OUTLINE



- NOTES:
- All linear dimensions are in millimeters.
 - This drawing is subject to change without notice.
 - Publication IPC-7351 is recommended for alternate designs.
 - Laser cutting apertures with trapezoidal walls and also rounding corners will offer better paste release. Customers should contact their board assembly site for stencil design recommendations. Refer to IPC-7525 for other stencil recommendations.
 - Customers should contact their board fabrication site for solder mask tolerances between and around signal pads.

IMPORTANT NOTICE

Texas Instruments Incorporated and its subsidiaries (TI) reserve the right to make corrections, enhancements, improvements and other changes to its semiconductor products and services per JESD46, latest issue, and to discontinue any product or service per JESD48, latest issue. Buyers should obtain the latest relevant information before placing orders and should verify that such information is current and complete. All semiconductor products (also referred to herein as "components") are sold subject to TI's terms and conditions of sale supplied at the time of order acknowledgment.

TI warrants performance of its components to the specifications applicable at the time of sale, in accordance with the warranty in TI's terms and conditions of sale of semiconductor products. Testing and other quality control techniques are used to the extent TI deems necessary to support this warranty. Except where mandated by applicable law, testing of all parameters of each component is not necessarily performed.

TI assumes no liability for applications assistance or the design of Buyers' products. Buyers are responsible for their products and applications using TI components. To minimize the risks associated with Buyers' products and applications, Buyers should provide adequate design and operating safeguards.

TI does not warrant or represent that any license, either express or implied, is granted under any patent right, copyright, mask work right, or other intellectual property right relating to any combination, machine, or process in which TI components or services are used. Information published by TI regarding third-party products or services does not constitute a license to use such products or services or a warranty or endorsement thereof. Use of such information may require a license from a third party under the patents or other intellectual property of the third party, or a license from TI under the patents or other intellectual property of TI.

Reproduction of significant portions of TI information in TI data books or data sheets is permissible only if reproduction is without alteration and is accompanied by all associated warranties, conditions, limitations, and notices. TI is not responsible or liable for such altered documentation. Information of third parties may be subject to additional restrictions.

Resale of TI components or services with statements different from or beyond the parameters stated by TI for that component or service voids all express and any implied warranties for the associated TI component or service and is an unfair and deceptive business practice. TI is not responsible or liable for any such statements.

Buyer acknowledges and agrees that it is solely responsible for compliance with all legal, regulatory and safety-related requirements concerning its products, and any use of TI components in its applications, notwithstanding any applications-related information or support that may be provided by TI. Buyer represents and agrees that it has all the necessary expertise to create and implement safeguards which anticipate dangerous consequences of failures, monitor failures and their consequences, lessen the likelihood of failures that might cause harm and take appropriate remedial actions. Buyer will fully indemnify TI and its representatives against any damages arising out of the use of any TI components in safety-critical applications.

In some cases, TI components may be promoted specifically to facilitate safety-related applications. With such components, TI's goal is to help enable customers to design and create their own end-product solutions that meet applicable functional safety standards and requirements. Nonetheless, such components are subject to these terms.

No TI components are authorized for use in FDA Class III (or similar life-critical medical equipment) unless authorized officers of the parties have executed a special agreement specifically governing such use.

Only those TI components which TI has specifically designated as military grade or "enhanced plastic" are designed and intended for use in military/aerospace applications or environments. Buyer acknowledges and agrees that any military or aerospace use of TI components which have **not** been so designated is solely at the Buyer's risk, and that Buyer is solely responsible for compliance with all legal and regulatory requirements in connection with such use.

TI has specifically designated certain components as meeting ISO/TS16949 requirements, mainly for automotive use. In any case of use of non-designated products, TI will not be responsible for any failure to meet ISO/TS16949.

Products

Audio	www.ti.com/audio
Amplifiers	amplifier.ti.com
Data Converters	dataconverter.ti.com
DLP® Products	www.dlp.com
DSP	dsp.ti.com
Clocks and Timers	www.ti.com/clocks
Interface	interface.ti.com
Logic	logic.ti.com
Power Mgmt	power.ti.com
Microcontrollers	microcontroller.ti.com
RFID	www.ti-rfid.com
OMAP Applications Processors	www.ti.com/omap
Wireless Connectivity	www.ti.com/wirelessconnectivity

Applications

Automotive and Transportation	www.ti.com/automotive
Communications and Telecom	www.ti.com/communications
Computers and Peripherals	www.ti.com/computers
Consumer Electronics	www.ti.com/consumer-apps
Energy and Lighting	www.ti.com/energy
Industrial	www.ti.com/industrial
Medical	www.ti.com/medical
Security	www.ti.com/security
Space, Avionics and Defense	www.ti.com/space-avionics-defense
Video and Imaging	www.ti.com/video

TI E2E Community

e2e.ti.com