

ISL8225MEVAL3Z Evaluation Board User Guide

The ISL8225M is a complete, dual step-down switching mode DC/DC module. The dual outputs can easily be paralleled for single-output, high-current use. It is easy to apply this high-power, current-sharing DC/DC power module to power-hungry datacom, telecom, and FPGA applications. All that is needed in order to have a complete, 30A design ready for use are the ISL8225M, a few passive components and V_{OUT} setting resistors.

The ease of use virtually eliminates design and manufacturing risks while dramatically improving time to market.

The simplicity of the ISL8225M is its off-the-shelf, unassisted implementation. Patented module structure allows for higher power density and better efficiency than competing solutions. Patented current sharing in multiphase operation greatly reduces ripple currents, BOM costs, and complexity.

The ISL8225MEVAL3Z evaluation board enables a single output by paralleling two phases to deliver 30A continuous load current. The ISL8225M supports input voltage from 4.5V to 20V and the output voltage ranges from 0.6V to 7.5V. With the single resistor modification, the output voltage can be easily adjusted to different voltages.

Related Resources



See how-to video at intersil.com/evid01

Related Literature

- [ISL8225M](#) Datasheet

Specifications

This board has been configured and optimized for the following operating conditions:

- $V_{IN} = 4.5V$ to $20V$, $V_O = 1.2V$
- $I_O = 30A$
- $f_{SW} = 500kHz$
- 180° phase shift between phases

Key Features

- Up to 100W output
- Single 30A output
- 4.5V to 20V input range
- 0.6V to 7.5V output range
- 1.5% output voltage accuracy
- Up to 95% conversion efficiency
- Lower output ripple and input ripple due to 180° phase shift

Recommended Equipment

- 0V to 20V power supply with at least 10A source current capability
- Electronic load capable of sinking current up to 30A
- Digital multimeters (DMMs)
- 100MHz quad-trace oscilloscope

Ordering Information

PART NUMBER	DESCRIPTION
ISL8225MEVAL3Z	30A, Single Output Evaluation Board



FIGURE 1. ISL8225MEVAL3Z BOARD IMAGE

High Output Voltage Operation

The evaluation board is designed for output voltage below 5.5V. For output voltage higher than 6V, capacitors with 10V rating must be used for C10 to C14. Please refer to Table 1 in [ISL8225M](#) datasheet for selections of output capacitors, input capacitors and switching frequency. The maximum load capability is 20A for 6.5V output and 14A for 7.5V output.

Quick Start

The inputs are J1 (VIN) and J2 (GND). The outputs are J3 (VOUT) and J4 (GND). Refer to [Figure 1](#) for connections.

1. Connect a power supply capable of sourcing at least 10A to the input (VIN J1 and GND J2) of the ISL8225MEVAL3Z evaluation board, with a voltage between 4.5V to 20V. Connect an electronic load or the device to be powered to the output (VOUT J3 and GND J4) of the board. All connections, especially the low voltage, high current V_{OUT} lines, should be able to carry the desired load current and should be made as short as possible.
2. Turn on the power supply. Measure the output voltage, V_{OUT}, which should be at 1.2V if the board is working properly.
3. The ISL8225MEVAL3Z is manufactured with a default V_{OUT} value of 1.2V; if different output voltages are desired, board resistors can be exchanged to provide the desired V_{OUT}. Please refer to the table printed on the backside of the evaluation board or [Table 1](#) for R_{VSET} resistor values, which can be used to produce different output voltages.

For 12V V_{IN}, and V_{OUT} more than 1.5V, the switching frequency will need to be adjusted, as shown in [Table 1](#); no frequency adjustments are necessary for V_{OUT} below 1.5V. For 5V V_{IN}, the frequency does not need to be adjusted and the module default frequency can be used at any allowed V_{OUT}. If the output voltage is set to more than 1.8V, the output current will need to be derated to allow for safe operation at elevated ambient temperatures. Please refer to the derating curves in the [ISL8225M](#) datasheet.

For V_{IN} < 5.5V, please tie VIN directly to VCC for best efficiency. Also, it is preferred that the EN/FF voltage be over 1.5V in order to achieve better stability.

TABLE 1. RESISTANCE SETTING FOR DIFFERENT OUTPUT VOLTAGES AND OPERATING FREQUENCY (R₃ = 1k)

V _{OUT} (V)	R _{VSET} (Ω)	FREQUENCY (kHz)	R _{FSET} (Ω) (V _{IN} = 12V)
1.0	1500	Default	Default
1.2	Default	Default	Default
1.5	665	Default	Default
2.5	316	650	249k
3.3	221	800	124k
5.0	137	950	82.5k
5.5	121	950	82.5k
6.5	102	750	147k
7.5	86.6	750	147k

PCB Layout Guidelines

The evaluation board size is 3 inch x 3 inch. It is a 4-layer board, containing 2-ounce copper on the top and bottom layers and 1-ounce copper on all internal layers. The board can be used as a 30A reference design. Refer to the “Layout” section beginning on [page 5](#). The board is made up of FR4 material and all components, including the solder attachment, are lead-free.

Thermal Considerations and Current Derating

For high current applications, board layout is very critical in order to make the module operate safely and deliver maximum allowable power. To carry large currents, the board layout needs to be carefully designed to maximize thermal performance. To achieve this, select enough trace width, copper weight and the proper connectors.

This evaluation board is designed for running 30A at 1.2V at room temperature without additional cooling systems needed. However, if the output voltage is increased or the board is operated at elevated temperatures, then the available current is derated. Refer to the derated current curves in the [ISL8225M](#) datasheet to determine the output current available.

For layout of designs using the ISL8225M, the thermal performance can be improved by adhering to the following design tips:

1. Use the top and bottom layers to carry the large current. VOUT1, VOUT2, Phase 1, Phase 2, PGND, VIN1 and VIN2 should have large, solid planes. Place enough thermal vias to connect the power planes in different layers under and around the module.
2. Phase 1 and Phase 2 pads are switching nodes that generate switching noise. Keep these pads under the module. For noise-sensitive applications, it is recommended to keep phase pads only on the top and inner layers of the PCB; do not place phase pads exposed to the outside on the bottom layer of the PCB. To improve the thermal performance, the phase pads can be extended in the inner layer, as shown in Phase 1 and Phase 2 pads on layer 3 (see [Figure 6](#)) for this 30A evaluation board. Make sure that layer 2 and layer 4 have the GND layers to cover the extended areas of phase pads at layer 3 to avoid noise coupling.
3. To avoid noise coupling, we recommend adding 470pF capacitors on all COMP pins of each module for multiple module operations.
4. If the ambient temperature is high or the board space is limited, airflow is needed to dissipate more heat from the modules. A heat sink can also be applied to the top side of the module to further improve the thermal performance (heat sink recommendation: Aavid Thermalloy, part number 375424B00034G, www.aavid.com).

ISL8225MEVAL3Z Board Schematic

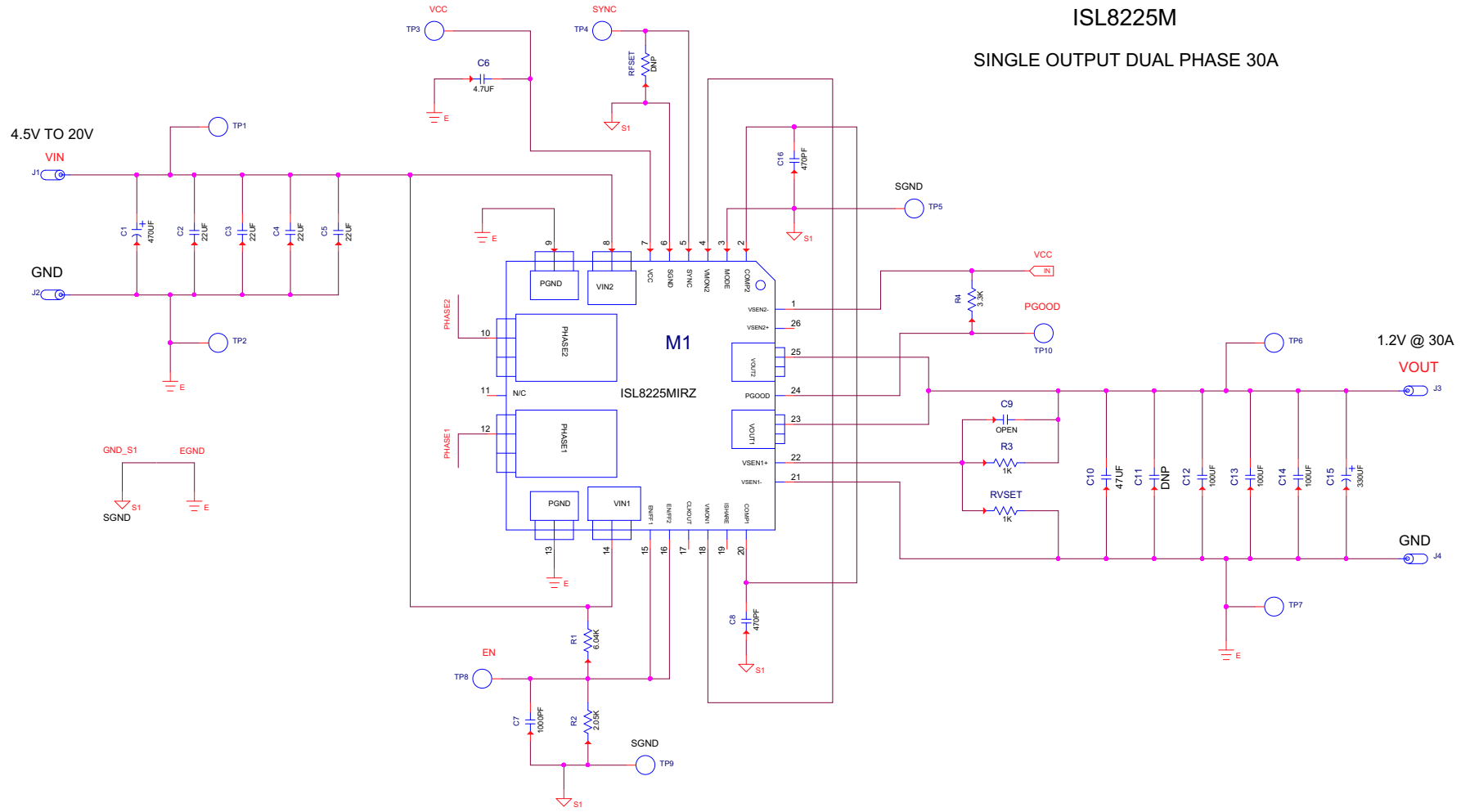

ISL8225M
SINGLE OUTPUT DUAL PHASE 30A

FIGURE 2. ISL8225MEVAL3Z BOARD SCHEMATIC

Bill of Materials

PART NUMBER	REF DES	QTY.	VALUE	TOL.	VOLTAGE	POWER	PACKAGE TYPE	JEDEC TYPE	MANUFACTURER	DESCRIPTION
108-0740-001	J1-J4	4					CONN	BAN-JACK	Johnson Components	Standard type banana jack
10TPB330M	C15	1	330 μ F	20%	10V		SMD	CAP_7343_149	SANYO-POSCAP	Standard solid electrolytic chip tantalum SMD capacitor
5002	TP1-TP10	10					THOLE	MTP500X	Keystone	Miniature white test point 0.100 pad 0.040 Thole
EEE1EA471P	C1	1	470 μ F	20%	25V		SMD	CAPAE_393X402	Panasonic	Aluminum electrolytic S series type V capacitor (RoHS compliant)
GRM32ER71E226KE15L	C2-C5	4	22 μ F	10%	25V		1210	CAP_1210	Murata	Ceramic chip capacitor
H1045-00102-50V10-T	C7	1	1000pF	10%	50V		603	CAP_0603	Generic	Multilayer capacitor
H1045-00471-50V10	C8, C16	2	470pF	10%	50V		603	CAP_0603	Generic	Multilayer capacitor
H1045-00475-6R3V10-T	C6	1	4.7 μ F	10%	6.3V		603	CAP_0603	Generic	Multilayer capacitor
H1045-OPEN	C9	1	OPEN	5%	OPEN		603	CAP_0603	Generic	Multilayer capacitor
H1046-00476-6R3V20-T	C10	1	47 μ F	20%	6.3V		805	CAP_0805	Generic	Multilayer capacitor
H1065-00107-6R3V20-T	C12-C14	3	100 μ F	20%	6.3V		1206	CAP_1206	Generic	Multilayer capacitor
H1065-OPEN	C11	1	OPEN	5%	OPEN		1206	CAP_1206	Generic	Multilayer capacitor
H2505-DNP-DNP-1	RFSET	1	DNP	1%		DNP	603	RES_0603	Generic	Metal film chip resistor (do not populate)
H2511-02051-1/10W1-T	R2	1	2.05k Ω	1%		1/10W	603	RES_0603	Generic	Thick filmchip resistor
H2511-01001-1/16W1	R3, RVSET	2	1k Ω	1%		1/16W	603	RES_0603	Generic	Thick filmchip resistor
H2511-03301-1/16W5	R4	1	3.3k Ω	5%		1/16W	603	RES_0603	Generic	Thick filmchip resistor
H2511-06041-1/16W1	R1	1	6.04k Ω	1%		1/10W	603	RES_0603	Generic	Thick filmchip resistor
ISL8225MIRZ	M1	1					QFN	QFN26_670X670_ISL8225M	Intersil	Dual 15A DC/DC power module

NOTE: Resistance accuracy of feedback resistor divider R1/R2 can affect the output accuracy. Please use high accuracy resistance (i.e., 0.5% or 0.1%) to meet the output accuracy requirement.

Layout

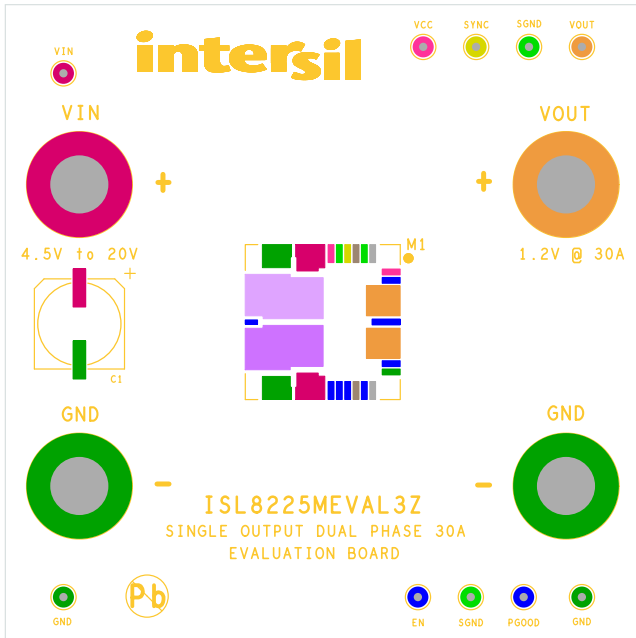

FIGURE 3. TOP COMPONENTS

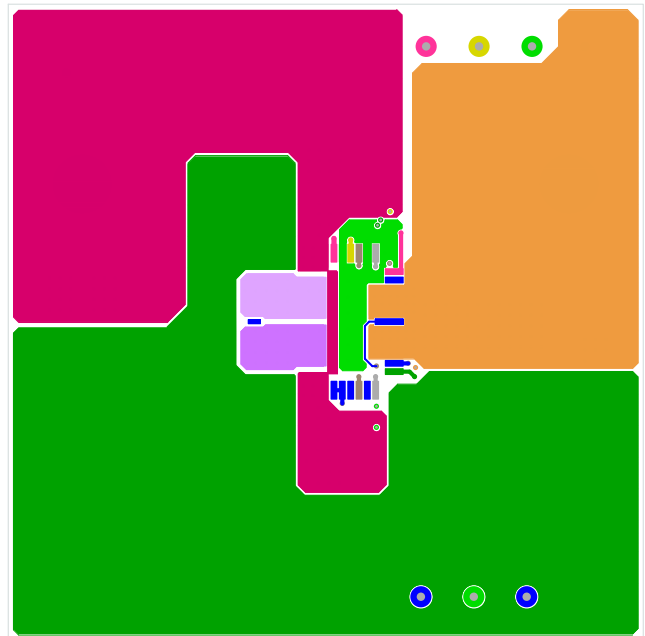

FIGURE 4. TOP LAYER

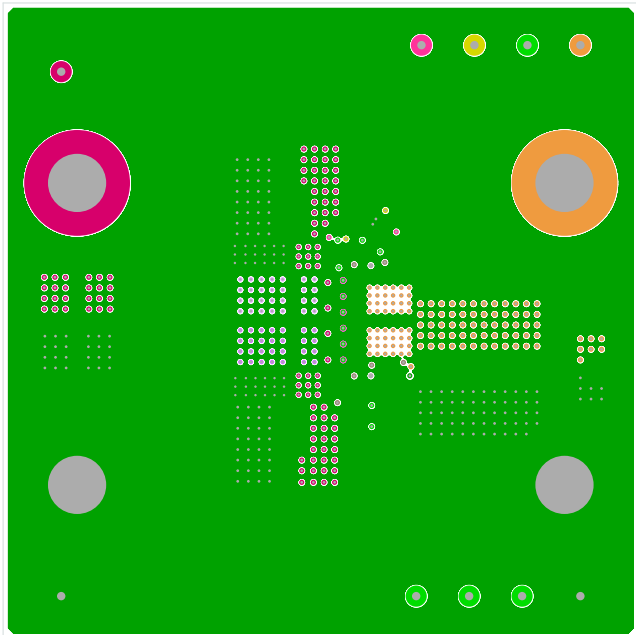

FIGURE 5. LAYER 2

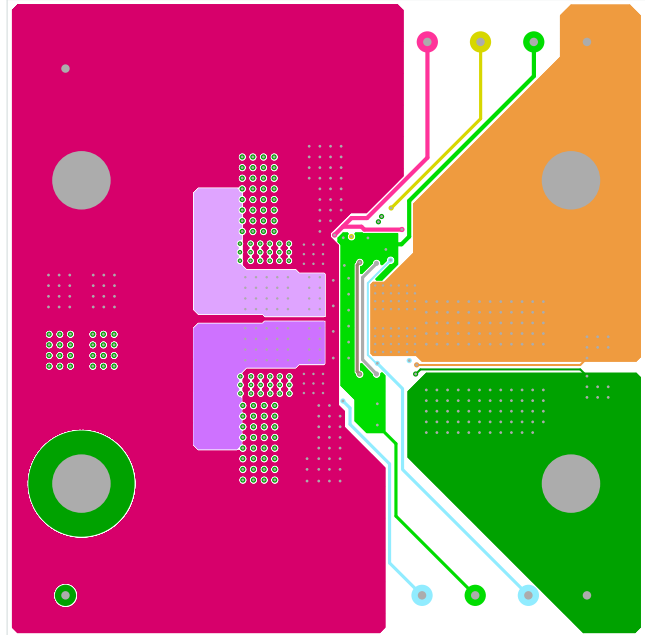

FIGURE 6. LAYER 3

Layout (Continued)

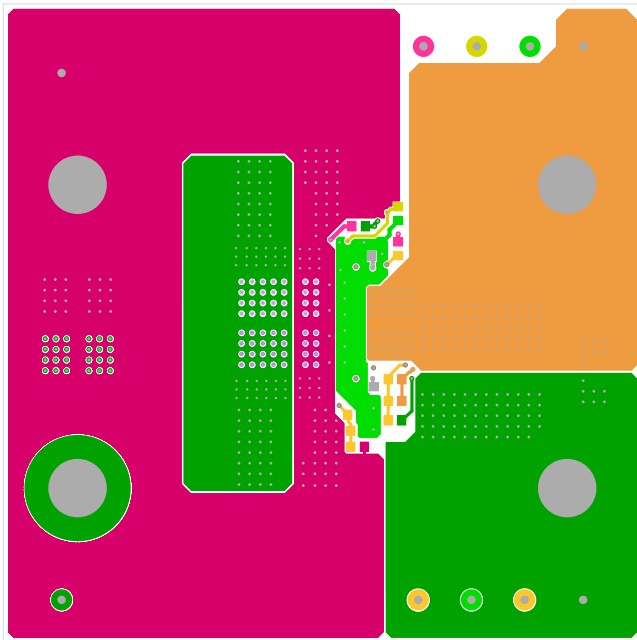

FIGURE 7. BOTTOM LAYER

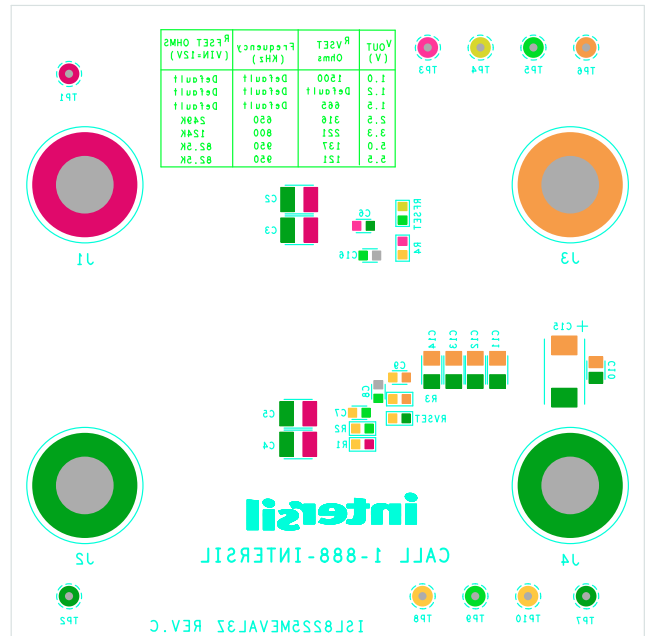

FIGURE 8. BOTTOM COMPONENTS

ISL8225MEVAL3Z Efficiency Curves

Test conditions at +25°C and no air flow.

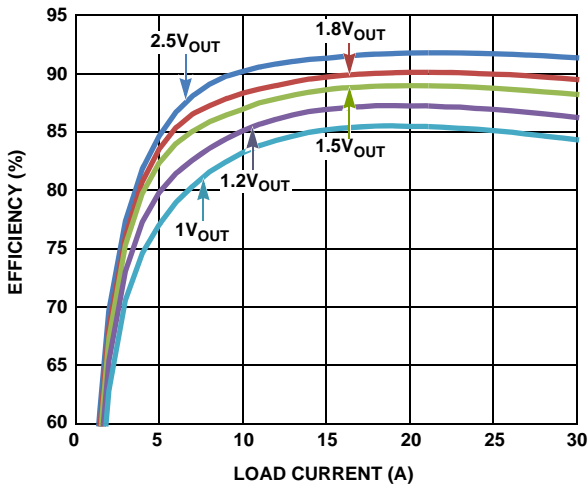

FIGURE 9. EFFICIENCY CURVES FOR 12V INPUT

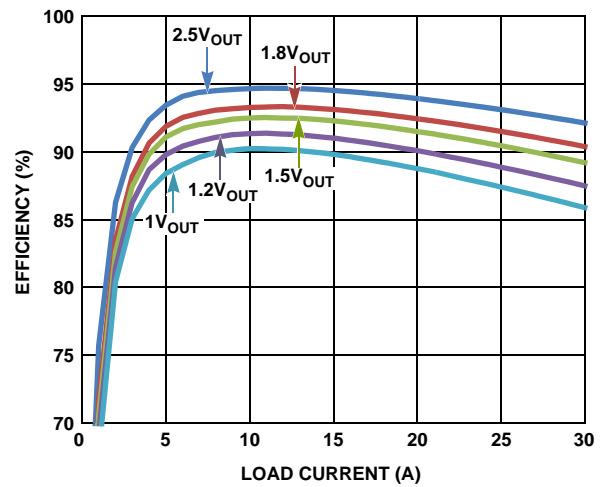

FIGURE 10. EFFICIENCY CURVES FOR 5V INPUT

Intersil Corporation reserves the right to make changes in circuit design, software and/or specifications at any time without notice. Accordingly, the reader is cautioned to verify that the Application Note or Technical Brief is current before proceeding.

For information regarding Intersil Corporation and its products, see www.intersil.com