

LM49100 Boomer® Audio Power Amplifier Series Mono Class AB Audio Sub-System with a True-Ground Headphone Amplifier

Check for Samples: [LM49100](#)

FEATURES

- Mono and Stereo Inputs
- Thermal Overload Protection
- True-Ground Headphone Drivers
- I²C Control Interface
- Input Mute Attenuation
- 2nd Stage Headphone Attenuator
- 32-Step Digital Volume Control
- 10 Operating Modes
- Minimum External Components
- Click and Pop Suppression
- Micro-Power Shutdown
- Available in Space-Saving 3mm x 3mm 25-Bump csBGA Package
- RF Suppression

KEY SPECIFICATIONS

- Power Output at VDD = 5V:
 - Loudspeaker (LS):
 - RL = 8Ω, THD+N ≤ 1% 1.275W
 - Headphone (VDDHP = 2.8V):
 - RL = 32Ω, THD+N ≤ 1%: 50mW
- Shutdown current 0.01μA

APPLICATIONS

- Mobile Phones
- PDAs
- Laptops
- Portable Electronics

DESCRIPTION

The LM49100 is a fully integrated audio subsystem capable of delivering 1.275W of continuous average power into a mono 8Ω bridged-tied load (BTL) with 1% THD+N and with a 5V power supply. The LM49100 also has a stereo true-ground headphone amplifier capable of 50mW per channel of continuous average power into a 32Ω single-ended (SE) loads with 1% THD+N.

The LM49100 has three input channels. One pair of SE inputs can be used with a stereo signal. The other input channel is fully differential and may be used with a mono input signal. The LM49100 features a 32-step digital volume control and ten distinct output modes. The mixer, volume control, and device mode select are controlled through an I²C compatible interface.

Thermal overload protection prevent the device from being damaged during fault conditions. Superior click and pop suppression eliminates audible transients on power-up/down and during shutdown.



Please be aware that an important notice concerning availability, standard warranty, and use in critical applications of Texas Instruments semiconductor products and disclaimers thereto appears at the end of this data sheet.

All trademarks are the property of their respective owners.

Typical Application

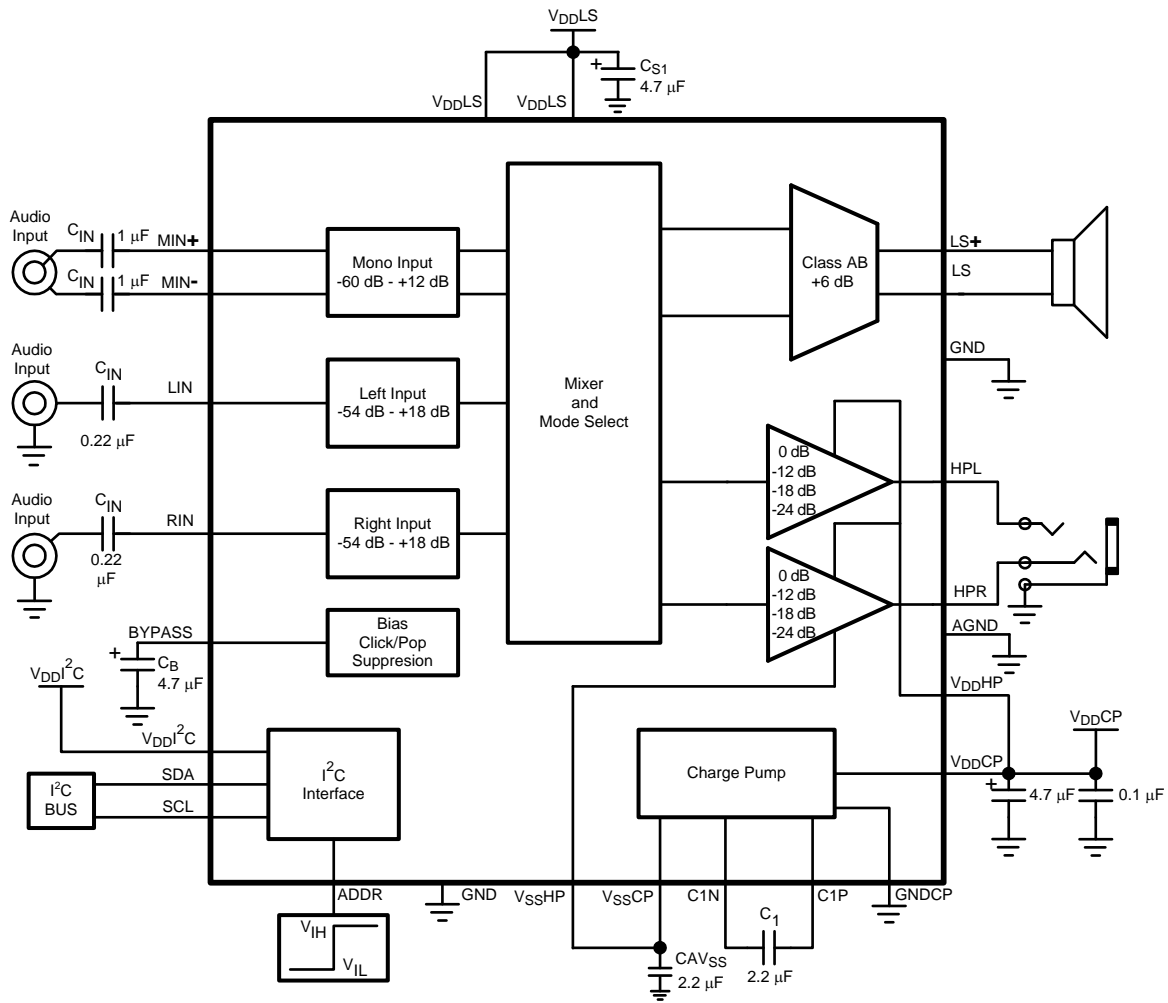
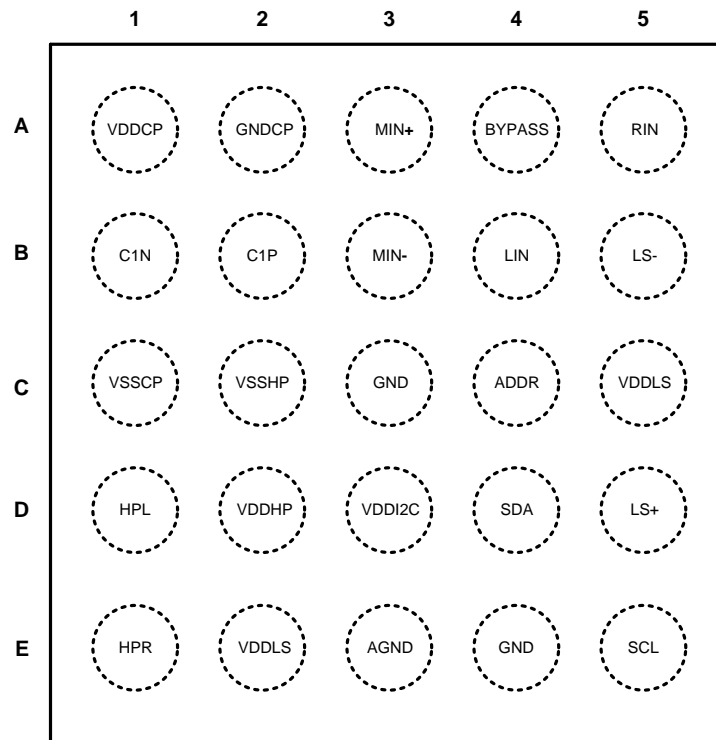

Figure 1. Typical Audio Amplifier Application Circuit

Connection Diagrams

**Figure 2. Top View
 25-Bump csBGA
 3mm x 3mm x 1mm
 See NYA0025A Package**

BUMP DESCRIPTIONS

Bump	Name	Description
A1	V _{DD} CP	Positive Charge Pump Power Supply
A2	GNDCP	Charge Pump Ground
A3	MIN+	Positive Mono Input
A4	BYPASS	Half-Supply Bypass
A5	RIN	Right Input
B1	C1N	Negative Terminal – Charge Pump Flying Capacitor
B2	C1P	Positive Terminal – Charge Pump Flying Capacitor
B3	MIN-	Negative Mono Input
B4	LIN	Left Input
B5	LS-	Negative Loudspeaker Output
C1	V _{SS} CP	Negative Charge Pump Power Supply
C2	V _{SS} HP	Negative Headphone Power Supply
C3	GND	Ground
C4	ADDR	I ² C Address Identification
C5	V _{DD} LS	Loudspeaker Power Supply
D1	HPL	Left Headphone Output
D2	V _{DD} HP	Positive Headphone Power Supply
D3	V _{DD} I ² C	I ² C Power Supply

BUMP DESCRIPTIONS (continued)

Bump	Name	Description
D4	SDA	I ² C Data
D5	LS+	Loudspeaker Output Positive
E1	HPR	Right Headphone Output
E2	V _{DD} LS	Loudspeaker Power Supply
E3	AGND	Headphone Signal Ground (See Application Information section).
E4	GND	Ground
E5	SCL	I ² C Clock



These devices have limited built-in ESD protection. The leads should be shorted together or the device placed in conductive foam during storage or handling to prevent electrostatic damage to the MOS gates.

Absolute Maximum Ratings ⁽¹⁾⁽²⁾⁽³⁾

Supply Voltage (Loudspeaker)	6V
Supply Voltage (Headphone)	3V
Storage Temperature	-65°C to +150°C
Input Voltage	-0.3V to $V_{DD} + 0.3V$
Power Dissipation ⁽⁴⁾	Internally Limited
ESD Susceptibility ⁽⁵⁾	2000V
ESD Susceptibility ⁽⁶⁾	200V
Junction Temperature	150°C
Thermal Resistance	
θ_{JA} (GR)	50.2°C/W

- (1) All voltages are measured with respect to the GND pin unless otherwise specified.
- (2) *Absolute Maximum Ratings* indicate limits beyond which damage to the device may occur. *Operating Ratings* indicate conditions for which the device is functional but do not ensure specific performance limits. *Electrical Characteristics* state DC and AC electrical specifications under particular test conditions which specify performance limits. This assumes that the device is within the Operating Ratings. Specifications are not for parameters where no limit is given, however, the typical value is a good indication of device performance.
- (3) If Military/Aerospace specified devices are required, please contact the Texas Instruments Sales Office/ Distributors for availability and specifications.
- (4) The maximum power dissipation must be derated at elevated temperatures and is dictated by T_{JMAX} , θ_{JA} , and the ambient temperature, T_A . The maximum allowable power dissipation is $P_{DMAX} = (T_{JMAX} - T_A) / \theta_{JA}$ or the number given in Absolute Maximum Ratings, whichever is lower. For the LM49100, see power derating currents for more information.
- (5) Human body model, 100 pF discharged through a 1.5k Ω resistor.
- (6) Machine Model, 220pF - 240pF discharged through all pins.

Operating Ratings

Temperature Range	
$T_{MIN} \leq T_A \leq T_{MAX}$	$-40^\circ\text{C} \leq T_A \leq +85^\circ\text{C}$
Supply Voltage V_{DDLS}	$2.7V \leq V_{DDLS} \leq 5.5V$
Supply Voltage V_{DDHP}	$2.4V \leq V_{DDHP} \leq 2.9V$
I ² C Voltage (V_{DDI^2C})	$1.7V \leq V_{DDI^2C} \leq 5.5V$ $V_{DDHP} \leq V_{DDLS}$ $V_{DDI^2C} \leq V_{DDLS}$

Electrical Characteristics $V_{DDLS} = 3.6V$, $V_{DDHP} = 2.8V$ ⁽¹⁾⁽²⁾

The following specifications apply for all programmable gain set to 0 dB, $C_B = 4.7\mu F$, $R_{L(SP)} = 8\Omega$, $R_{L(HP)} = 32\Omega$, $f = 1$ kHz unless otherwise specified. Limits apply for $T_A = 25^\circ C$.

Symbol	Parameter	Conditions		LM49100		Units (Limits)		
				Typical ⁽³⁾	Limit ⁽⁴⁾			
I_{DD}	Supply Current	$V_{DDLS} = 3.0V$ $V_{DDHP} = 2.8V$	Modes 1, 3, 5 $V_{IN} = 0V$, No Load	2.9		mA		
			Modes 2, 4, 6 $V_{IN} = 0V$, No Load	3.4		mA		
			Modes 7, 10, 14 $V_{IN} = 0V$, No Load	4.8		mA		
		$V_{DDLS} = 3.6V$ $V_{DDHP} = 2.8V$	Modes 1, 3, 5 $V_{IN} = 0V$, No Load	2.9	4.3	mA (max)		
			Modes 2, 4, 6 $V_{IN} = 0V$, No Load	3.5	5.4	mA (max)		
			Modes 7, 10, 14 $V_{IN} = 0V$, No Load	4.8	7.4	mA (max)		
		$V_{DDLS} = 5.0V$ $V_{DDHP} = 2.8V$	Modes 1, 3, 5 $V_{IN} = 0V$, No Load	3.1		mA		
			Modes 2, 4, 6 $V_{IN} = 0V$, No Load	3.6		mA		
			Modes 7, 10, 14 $V_{IN} = 0V$, No Load	5.0		mA		
I_{SD}	Shutdown Supply Current	Mode 0		0.01	1	μA (max)		
V_{OS}	Output Offset Voltage	$V_{IN} = 0V$, Mode 7, Mono		6.0	25	mV (max)		
		$V_{IN} = 0V$, Mode 7, Headphone Gain = -24dB		2.2	5.5	mV		
		$V_{IN} = 0V$, Mode 7, Headphone Gain = -18dB		2.4		mV (max)		
		$V_{IN} = 0V$, Mode 7, Headphone Gain = -12dB		3.2		mV		
		$V_{IN} = 0V$, Mode 7, Headphone Gain = 0dB		7	15	mV (max)		
P_{OUT}	Output Power	$V_{DDLS} = 3.0V$	LS $f = 1kHz$	$R_L = 8\Omega$ 1% 10%	425 525		mW mW	
				HP $f = 1kHz$	$R_L = 16\Omega$ 1% 10%	49 69		mW mW
			$R_L = 32\Omega$ 1% 10%		35 44		mW mW	
			LS $f = 1kHz$		$R_L = 8\Omega$ 1% 10%	640 790	600	mW (min) mW
					HP $f = 1kHz$	$R_L = 16\Omega$ 1% 10%	49 72	
			$R_L = 32\Omega$ 1% 10%	50 62		46	mW (min) mW	

- (1) All voltages are measured with respect to the GND pin unless otherwise specified.
- (2) *Absolute Maximum Ratings* indicate limits beyond which damage to the device may occur. *Operating Ratings* indicate conditions for which the device is functional but do not ensure specific performance limits. *Electrical Characteristics* state DC and AC electrical specifications under particular test conditions which specify performance limits. This assumes that the device is within the Operating Ratings. Specifications are not for parameters where no limit is given, however, the typical value is a good indication of device performance.
- (3) Typicals are measured at $25^\circ C$ and represent the parametric norm.
- (4) Limits are specified to AOQL (Average Outgoing Quality Level).

Electrical Characteristics $V_{DDLS} = 3.6V$, $V_{DDHP} = 2.8V$ ⁽¹⁾⁽²⁾ (continued)

The following specifications apply for all programmable gain set to 0 dB, $C_B = 4.7\mu F$, $R_L(SP) = 8\Omega$, $R_L(HP) = 32\Omega$, $f = 1$ kHz unless otherwise specified. Limits apply for $T_A = 25^\circ C$.

Symbol	Parameter	Conditions		LM49100		Units (Limits)
				Typical ⁽³⁾	Limit ⁽⁴⁾	
P_{OUT}	Output Power	$V_{DDLS} = 5.0V$	LS $f = 1kHz$	$R_L = 8\Omega$ 1% 10%	1275 1575	mW mW
			HP $f = 1kHz$	$R_L = 16\Omega$ 1% 10%	49 72	mW mW
				$R_L = 32\Omega$ 1% 10%	53 62	mW mW
THD+N	Total Harmonic Distortion + Noise	$V_{DDLS} = 3.0V$	$f = 1kHz$	Loudspeaker; Mode 1, $R_L = 8\Omega$, $P_{OUT} = 215mW$	0.05	%
				Headphone; Mode 4, $R_L = 32\Omega$, $P_{OUT} = 25mW$	0.02	%
THD+N	Total Harmonic Distortion + Noise	$V_{DDLS} = 3.6V$	$f = 1kHz$	Loudspeaker; Mode 1, $R_L = 8\Omega$, $P_{OUT} = 320mW$	0.05	%
				Headphone; Mode 4, $R_L = 32\Omega$, $P_{OUT} = 25mW$	0.02	%
THD+N	Total Harmonic Distortion + Noise	$V_{DDLS} = 5.0V$	$f = 1kHz$	Loudspeaker; Mode 1, $R_L = 8\Omega$, $P_{OUT} = 630mW$	0.035	%
				Headphone; Mode 4, $R_L = 32\Omega$, $P_{OUT} = 25mW$	0.02	%
e_N	Noise	A-weighted, 0 dB, inputs terminated to GND, output referred	Headphone			
			Mode 2, 10	12		μV
			Mode 4, 7	13		μV
			Mode 6, 14	16		μV
			Loudspeaker			
			Mode 1	14		μV
			Mode 3, 7, 10, 14	23		μV
			Mode 5	27		μV
T_{ON}	Turn-on Time			26		ms
T_{OFF}	Turn-off Time			1		ms
Z_{IN}	Input Impedance	Maximum gain setting		12.5	10 15	k Ω (min) k Ω (max)
		Maximum attenuation setting		110	90 130	k Ω (min) k Ω (max)

Electrical Characteristics $V_{DDLS} = 3.6V$, $V_{DDHP} = 2.8V$ ⁽¹⁾⁽²⁾ (continued)

The following specifications apply for all programmable gain set to 0 dB, $C_B = 4.7\mu F$, $R_L(SP) = 8\Omega$, $R_{L(HP)} = 32\Omega$, $f = 1$ kHz unless otherwise specified. Limits apply for $T_A = 25^\circ C$.

Symbol	Parameter	Conditions	LM49100		Units (Limits)	
			Typical ⁽³⁾	Limit ⁽⁴⁾		
A_V	Volume Control	Stereo (Left and Right Channels)	Input referred maximum attenuation	-54	-52 -56	dB (min) dB (max)
			Input referred maximum gain	18	17.5 18.5	dB (min) dB (max)
		Mono	Input referred maximum attenuation	-60	-58 -62	dB (min) dB (max)
			Input referred maximum gain	12	11.5 12.5	dB (min) dB (max)
CMRR	Common Mode Rejection Ratio	Headphone Mode 2, $f = 217$ Hz, $V_{CM} = 1 V_{PP}$, $R_L = 32\Omega$	64		dB	
		Loudspeaker Mode 1, $f = 217$ Hz, $V_{CM} = 1 V_{PP}$, $R_L = 8\Omega$	58		dB	
PSRR	Power Supply Rejection Ratio	$V_{RIPPLE} = 200mV_{pp}$ on V_{DD} LS, output referred, inputs terminated to GND, $f = 217Hz$				
		LS, Mode 1	90		dB	
		LS, Mode 3, 7, 10, 14	78		dB	
PSRR	Power Supply Rejection Ratio	$V_{RIPPLE} = 200mV_{pp}$ on V_{DD} HP, output referred, inputs terminated to GND, $f = 217Hz$				
		LS, Mode 7, 10, 14	83		dB	
PSRR	Power Supply Rejection Ratio	$V_{RIPPLE} = 200mV_{pp}$ on V_{DD} LS, output referred, inputs terminated to GND, $f = 217Hz$				
		HP, Mode 2, 10	90		dB	
		HP, Mode 4, 7	88		dB	
PSRR	Power Supply Rejection Ratio	$V_{RIPPLE} = 200mV_{pp}$ on V_{DD} HP, output referred, inputs terminated to GND, $f = 217Hz$				
		HP, Mode 2, 10	83		dB	
		HP, Mode 4, 7	83		dB	
PSRR	Power Supply Rejection Ratio	$V_{RIPPLE} = 200mV_{pp}$ on V_{DD} HP, output referred, inputs terminated to GND, $f = 217Hz$				
		HP, Mode 6, 14	80		dB	

I²C ⁽¹⁾⁽²⁾

The following specifications apply for $V_{DD} = 5.0V$ and $3.3V$, $T_A = 25^\circ C$, $2.2V \leq V_{DD} \leq 5.5V$, unless otherwise specified.

Symbol	Parameter	Conditions ⁽³⁾	LM49100		Units (Limits)
			Typical ⁽⁴⁾	Limits ⁽²⁾	
t_1	I ² C Clock Period			2.5	μs (min)
t_2	I ² C Data Setup Time			100	ns (min)
t_3	I ² C Data Stable Time			0	ns (min)
t_4	Start Condition Time			100	ns (min)
t_5	Stop Condition Time			100	ns (min)
t_6	I ² C Data Hold Time			100	ns (min)
V_{IH}	I ² C Input Voltage High			$0.7 \times V_{DD} I^2C$	V (min)
V_{IL}	I ² C Input Voltage Low			$0.3 \times V_{DD} I^2C$	V (max)

- (1) *Absolute Maximum Ratings* indicate limits beyond which damage to the device may occur. *Operating Ratings* indicate conditions for which the device is functional but do not ensure specific performance limits. *Electrical Characteristics* state DC and AC electrical specifications under particular test conditions which specify performance limits. This assumes that the device is within the Operating Ratings. Specifications are not for parameters where no limit is given, however, the typical value is a good indication of device performance.
- (2) Limits are specified to AOQL (Average Outgoing Quality Level).
- (3) Please refer to [Figure 32](#) (I²C Timing Diagram).
- (4) Typicals are measured at $25^\circ C$ and represent the parametric norm.

I²C (1)(2)

The following specifications apply for $V_{DD} = 5.0V$ and $3.3V$, $T_A = 25^\circ C$, $1.7V \leq V_{DD} \leq 2.2V$, unless otherwise specified.

Symbol	Parameter	Conditions ⁽³⁾	LM49100		Units (Limits)
			Typical ⁽⁴⁾	Limits ⁽²⁾	
t ₁	I ² C Clock Period			2.5	μs (min)
t ₂	I ² C Data Setup Time			250	ns (min)
t ₃	I ² C Data Stable Time			0	ns (min)
t ₄	Start Condition Time			250	ns (min)
t ₅	Stop Condition Time			250	ns (min)
t ₆	I ² C Data Hold Time			250	ns (min)
V _{IH}	I ² C Input Voltage High			0.7xV _{DD} I ² C	V (min)
V _{IL}	I ² C Input Voltage Low			0.3xV _{DD} I ² C	V (max)

- (1) *Absolute Maximum Ratings* indicate limits beyond which damage to the device may occur. *Operating Ratings* indicate conditions for which the device is functional but do not ensure specific performance limits. *Electrical Characteristics* state DC and AC electrical specifications under particular test conditions which specify performance limits. This assumes that the device is within the Operating Ratings. Specifications are not for parameters where no limit is given, however, the typical value is a good indication of device performance.
- (2) Limits are specified to AOQL (Average Outgoing Quality Level).
- (3) Please refer to [Figure 32](#) (I²C Timing Diagram).
- (4) Typicals are measured at 25°C and represent the parametric norm.

Typical Performance Characteristics

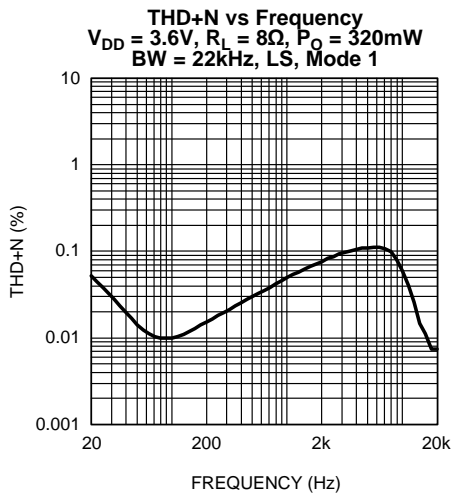

Figure 3.

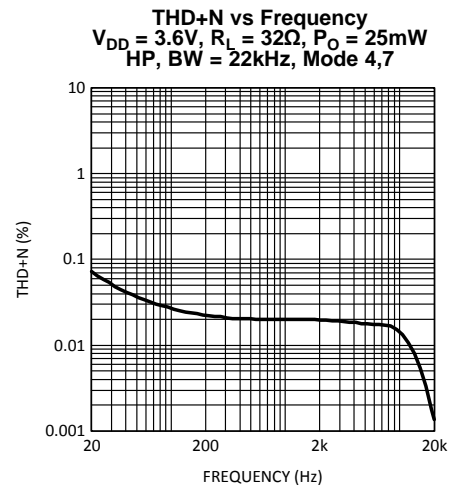

Figure 4.

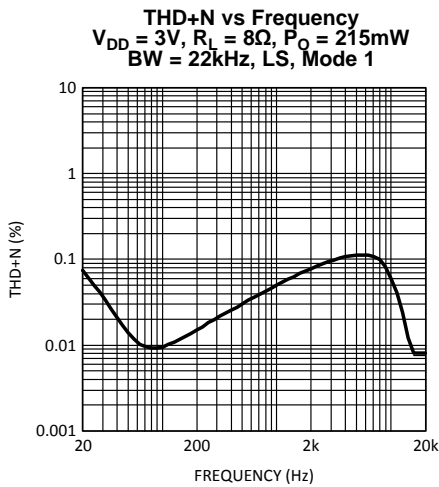

Figure 5.

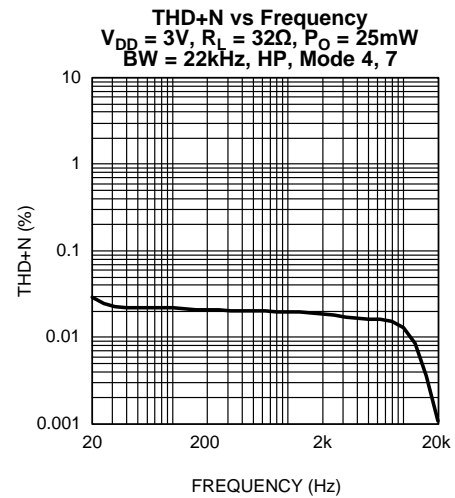

Figure 6.

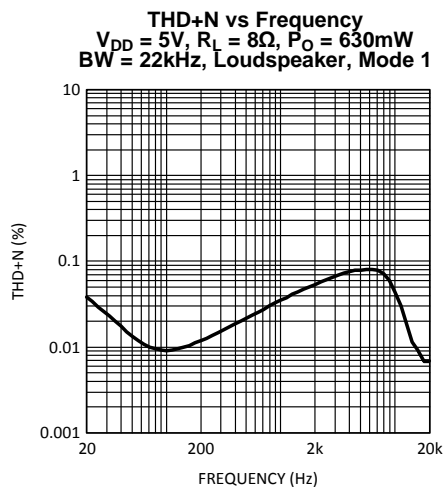

Figure 7.

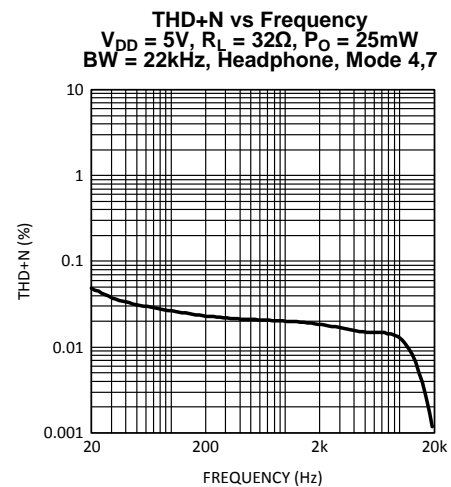

Figure 8.

Typical Performance Characteristics (continued)

THD+N vs Output Power
 $R_L = 32\Omega$, $f = 1\text{kHz}$
 $BW = 22\text{kHz}$, HP, Mode 4

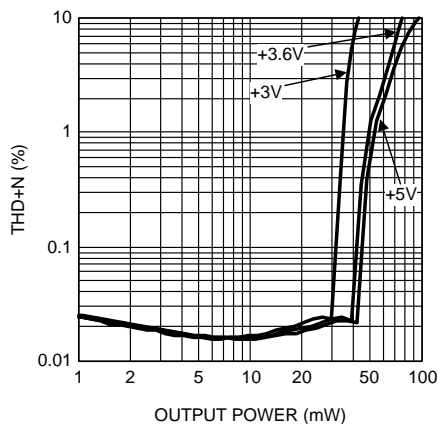

Figure 9.

THD+N vs Output Power
 $R_L = 8\Omega$, $f = 1\text{kHz}$
 $BW = 22\text{kHz}$, LS, Mode 1

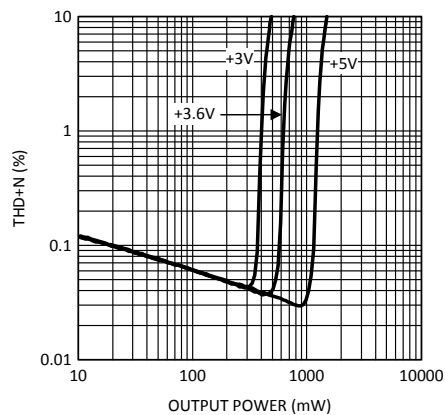

Figure 10.

Output Power vs Supply Voltage
 $V_{DDHP} = 2.8\text{V}$, $R_L = 8\Omega$,
 $f = 1\text{kHz}$, LS

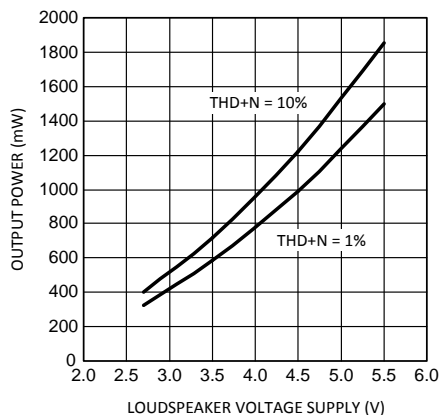

Figure 11.

Output Power vs Supply Voltage
 $V_{DDHP} = 2.8\text{V}$, $R_L = 32\Omega$,
 $f = 1\text{kHz}$, HP

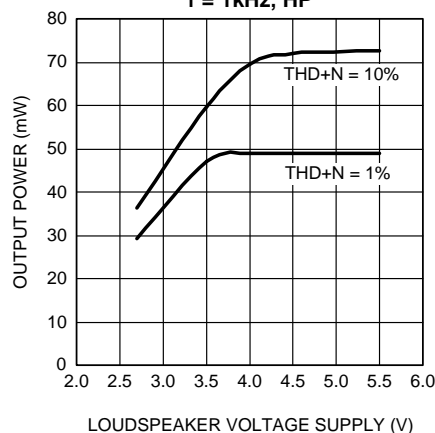

Figure 12.

Power Dissipation vs Output Power
 $V_{DD} = 3.6\text{V}$, $R_L = 8\Omega$,
 $f = 1\text{kHz}$, Mode 1

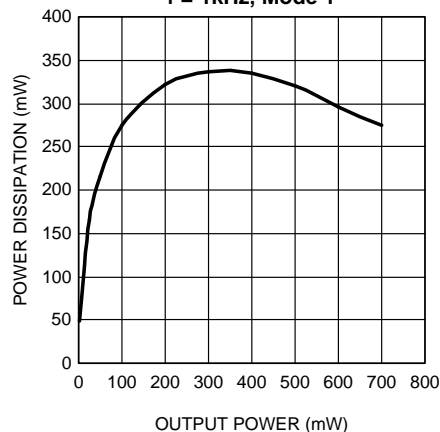

Figure 13.

Power Dissipation vs Output Power
 $V_{DD} = 3\text{V}$, $R_L = 8\Omega$,
 $f = 1\text{kHz}$, Mode 1

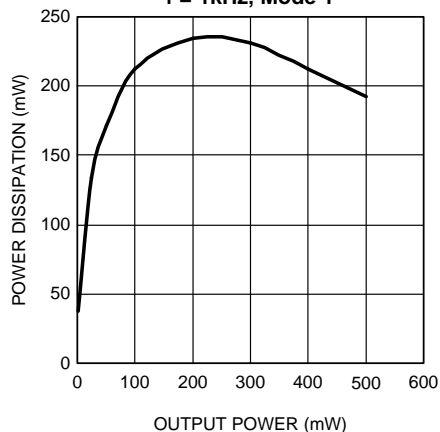

Figure 14.

Typical Performance Characteristics (continued)

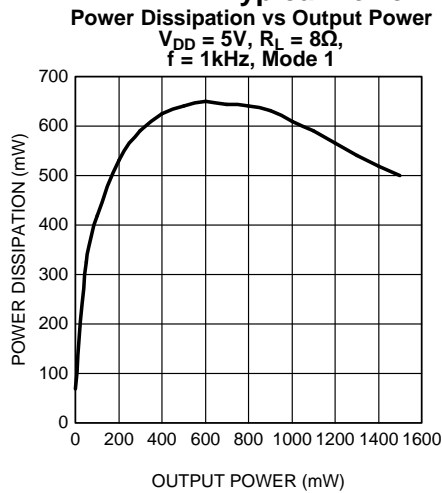

Figure 15.

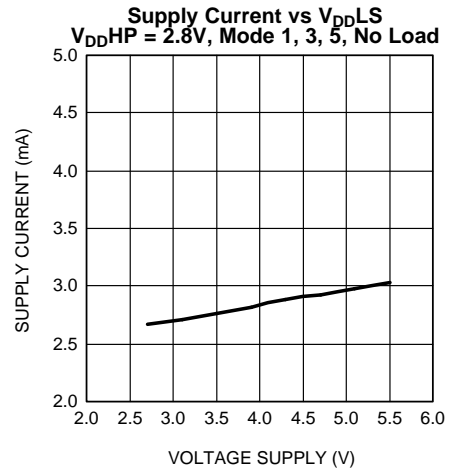

Figure 16.

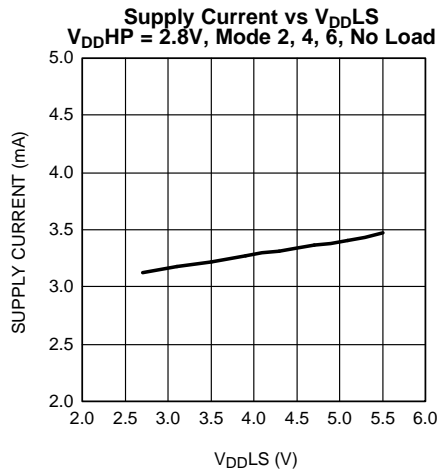

Figure 17.

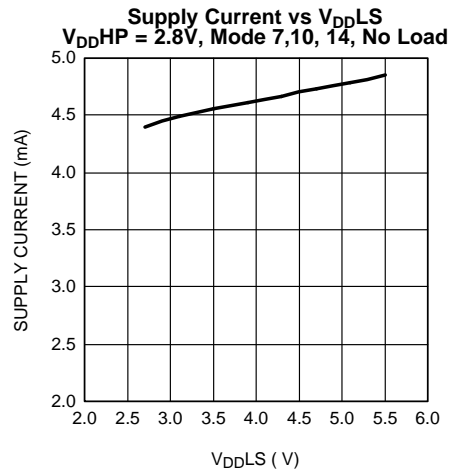

Figure 18.

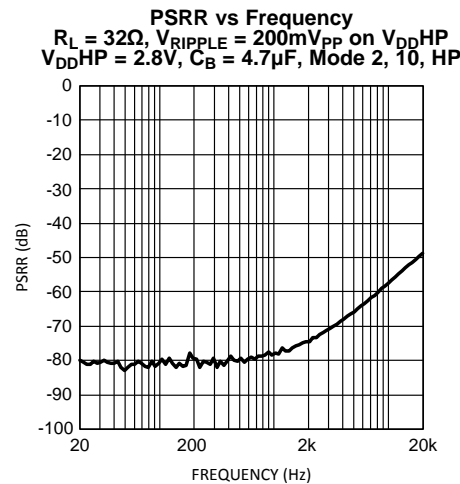

Figure 19.

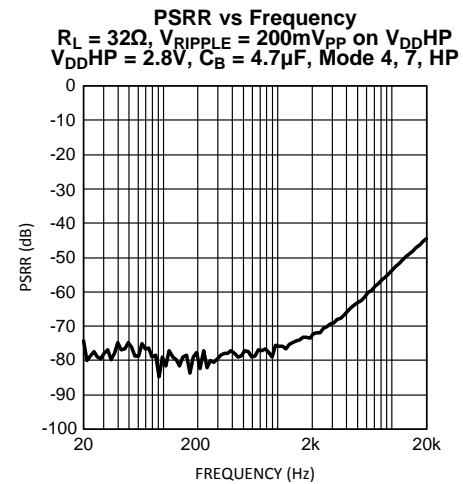

Figure 20.

Typical Performance Characteristics (continued)

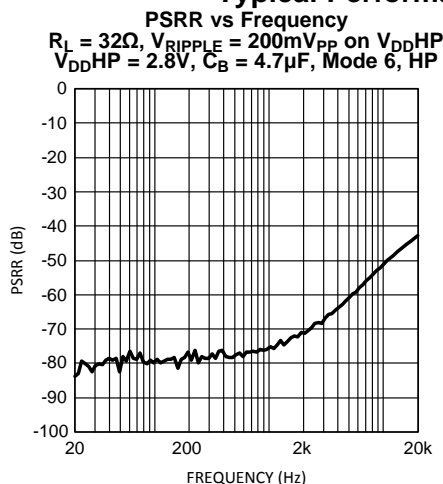

Figure 21.

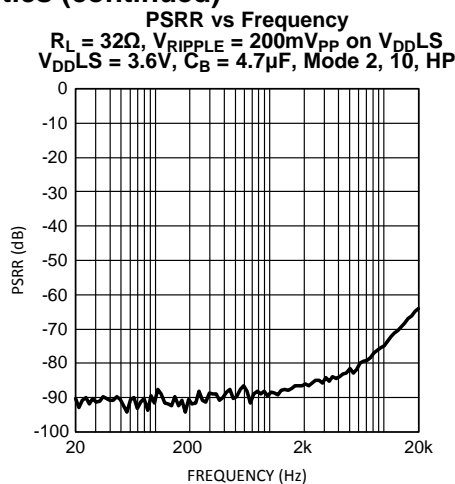

Figure 22.

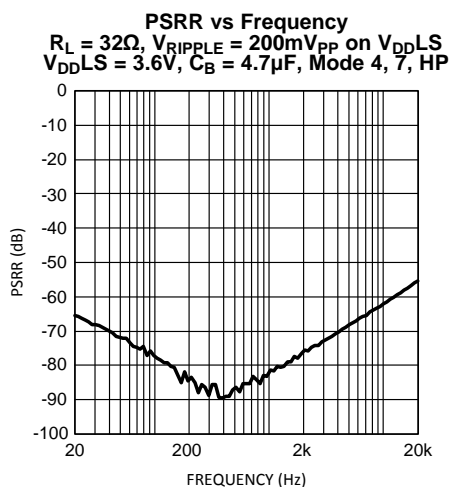

Figure 23.

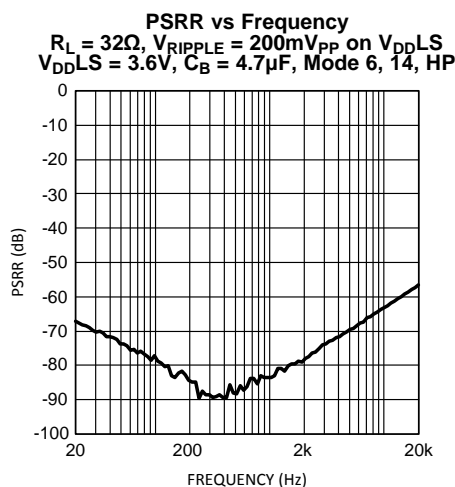

Figure 24.

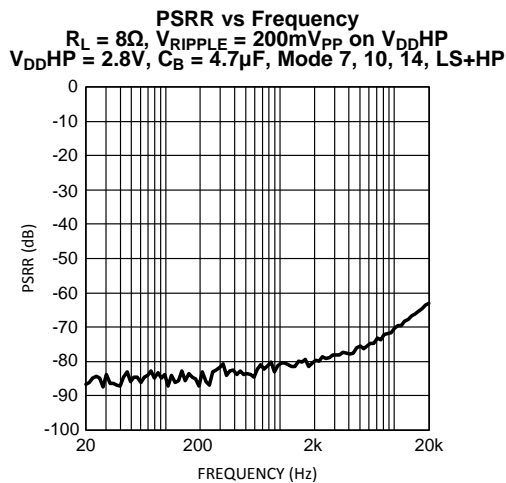

Figure 25.

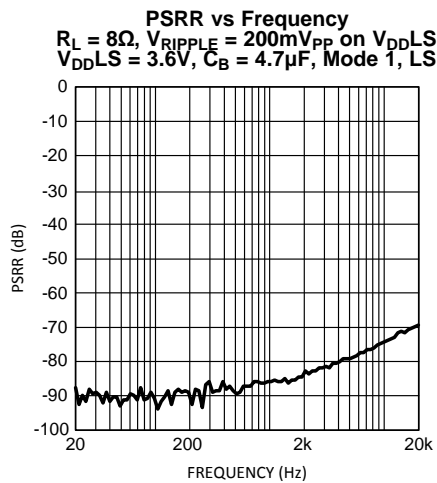

Figure 26.

Typical Performance Characteristics (continued)

PSRR vs Frequency
 $R_L = 8\Omega$, $V_{RIPPLE} = 200mV_{PP}$ on V_{DDLS}
 $V_{DDLS} = 3.6V$, $C_B = 4.7\mu F$, Mode 7, 10, 14, LS+HP

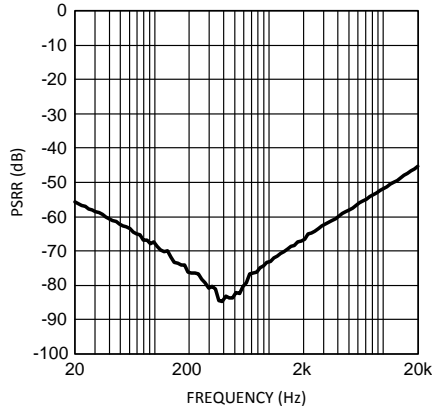

Figure 27.

PSRR vs Frequency
 $R_L = 8\Omega$, $V_{RIPPLE} = 200mV_{PP}$ on V_{DDLS}
 $V_{DDLS} = 3.6V$, $C_B = 4.7\mu F$, Mode 3, LS

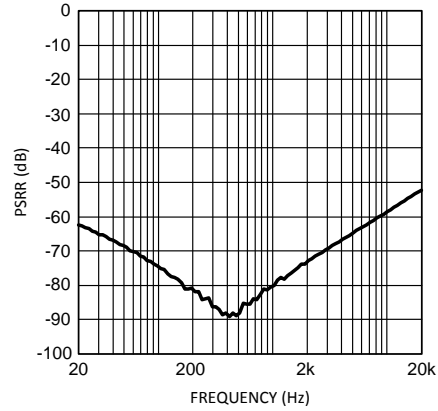

Figure 28.

PSRR vs Frequency
 $R_L = 8\Omega$, $V_{RIPPLE} = 200mV_{PP}$ on V_{DDLS}
 $V_{DDLS} = 3.6V$, $C_B = 4.7\mu F$, Mode 5, LS

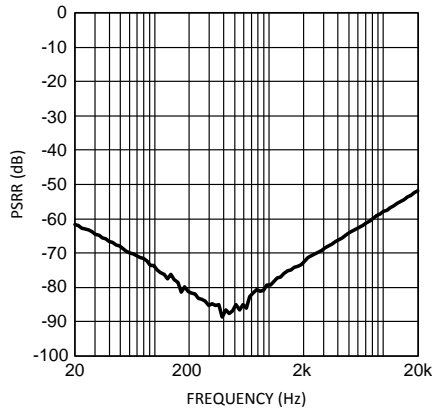

Figure 29.

Crosstalk vs Frequency
 $P_O = 12mW$, $f = 1kHz$, Mode 4, HP

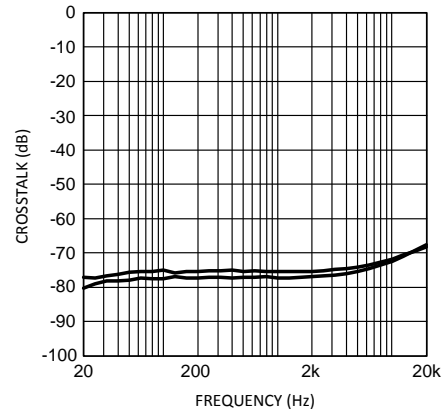

Figure 30.

LM49100 Control Tables

Table 1. I²C Control Register Table⁽¹⁾

	D7	D6	D5	D4	D3	D2	D1	D0
Modes Control	0	0	1	1	MC3	MC2	MC1	MC0
HP Volume (Gain) Control	0	1	INPUT_MUTE	0	0	HPR_SD	HPVC1	HPVC0
Mono Volume Control	1	0	0	MV4	MV3	MV2	MV1	MV0
Left Volume (Gain) Control	1	1	0	LV4	LV3	LV2	LV1	LV0
Right Volume (Gain) Control	1	1	1	RV4	RV3	RV2	RV1	RV0

(1) The LM49100 is controlled through an I²C compatible interface. The I²C chip address is 0xF8 (ADR pin = 0) or 0xFAh (ADDR pin = 1).

Table 2. Headphone Attenuation Control⁽¹⁾

Gain Select	HPVC1	HPVC0	Gain, dB
0	0	0	0
1	0	1	-12
2	1	0	-18
3	1	1	-24

(1) The following bits have added for extra headphone output attenuation:

Table 3. Output Mode Selection⁽¹⁾

Output Mode Number	MC3	MC2	MC1	MC0	Handsfree Mono Output	Right HP Output	Left HP Output
0	0	0	0	0	SD	SD	SD
1	0	0	0	1	$2 \times G_M \times M$	SD	SD
2	0	0	1	0	SD	$G_{HP} \times (G_M \times M)$	$G_{HP} \times (G_M \times M)$
3	0	0	1	1	$2 \times (G_L \times L + G_R \times R)$	SD	SD
4	0	1	0	0	SD	$G_{HP} \times (G_R \times R)$	$G_{HP} \times (G_L \times L)$
5	0	1	0	1	$2 \times (G_L \times L + G_R \times R + G_M \times M)$	SD	SD
6	0	1	1	0	SD	$G_{HP} \times (G_R \times R + G_M \times M)$	$G_{HP} \times (G_L \times L + G_M \times M)$
7	0	1	1	1	$2 \times (G_L \times L + G_R \times R)$	$G_{HP} \times (G_R \times R)$	$G_{HP} \times (G_L \times L)$
10	1	0	1	0	$2 \times (G_L \times L + G_R \times R)$	$G_{HP} \times (G_M \times M)$	$G_{HP} \times (G_M \times M)$
14	1	1	1	0	$2 \times (G_L \times L + G_R \times R)$	$G_{HP} \times (G_R \times R + G_M \times M)$	$G_{HP} \times (G_L \times L + G_M \times M)$

(1) G_L — Left channel gain
 G_R — Right channel gain
 G_M — Mono channel gain
 G_{HP} — Headphone Amplifier gain
R — Right input signal
L — Left input signal
SD — Shutdown
M — Mono input signal

Table 4. Mono/Stereo Left/Stereo Right Input Gain Control

Volume Step	MV4/LV4/RV4	MV3/LV3/RV3	MV2/LV2/RV2	MV1/LV1/RV1	MV0/LV0/RV0	R/L Gain, dB	MonoGain, dB
1	0	0	0	0	0	-54	-60
2	0	0	0	0	1	-47	-53
3	0	0	0	1	0	-40.5	-46.5
4	0	0	0	1	1	-34.5	-40.5
5	0	0	1	0	0	-30.0	-36

Table 4. Mono/Stereo Left/Stereo Right Input Gain Control (continued)

Volume Step	MV4/LV4/RV4	MV3/LV3/RV3	MV2/LV2/RV2	MV1/LV1/RV1	MV0/LV0/RV0	R/L Gain, dB	MonoGain, dB
6	0	0	1	0	1	-27	-33
7	0	0	1	1	0	-24	-30
8	0	0	1	1	1	-21	-27
9	0	1	0	0	0	-18	-24
10	0	1	0	0	1	-15	-21
11	0	1	0	1	0	-13.5	-19.5
12	0	1	0	1	1	-12	-18
13	0	1	1	0	0	-10.5	-16.5
14	0	1	1	0	1	-9	-15
15	0	1	1	1	0	-7.5	-13.5
16	0	1	1	1	1	-6	-12
17	1	0	0	0	0	-4.5	-10.5
18	1	0	0	0	1	-3	-9
19	1	0	0	1	0	-1.5	-7.5
20	1	0	0	1	1	0	-6
21	1	0	1	0	0	1.5	-4.5
22	1	0	1	0	1	3	-3
23	1	0	1	1	0	4.5	-1.5
24	1	0	1	1	1	6	0
25	1	1	0	0	0	7.5	1.5
26	1	1	0	0	1	9	3
27	1	1	0	1	0	10.5	4.5
28	1	1	0	1	1	12	6
29	1	1	1	0	0	13.5	7.5
30	1	1	1	0	1	15	9
31	1	1	1	1	0	16.5	10.5
32	1	1	1	1	1	18	12

APPLICATION INFORMATION

MINIMIZING CLICK AND POP

To minimize the audible click and pop heard through a headphone, maximize the input signal through the corresponding volume (gain) control registers and adjust the output amplifier gain accordingly to achieve the user's desired signal gain. For example, setting the output of the headphone amplifier to -24dB and setting the input volume control gain to 24dB will reduce the output offset from 7mV (typical) to 2.2mV (typical). This will reduce the audible click and pop noise significantly while maintaining a 0dB signal gain.

SIGNAL GROUND NOISE

The LM49100 has proprietary suppression circuitry, which provides an additional -50dB (typical) attenuation of the headphone ground noise and its incursion into the headphone. For optimum utilization of this feature the headphone jack ground should connect to the AGND (E3) bump.

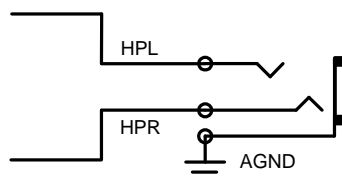

I²C PIN DESCRIPTION

SDA: This is the serial data input pin.

SCL: This is the clock input pin.

ADDR: This is the address select input pin.

I²C COMPATIBLE INTERFACE

The LM49100 uses a serial bus which conforms to the I²C protocol to control the chip's functions with two wires: clock (SCL) and data (SDA). The clock line is uni-directional. The data line is bi-directional (open-collector). The LM49100's I²C compatible interface supports standard (100kHz) and fast (400kHz) I²C modes. In this discussion, the master is the controlling microcontroller and the slave is the LM49100.

The I²C address for the LM49100 is determined using the ADDR pin. The LM49100's two possible I²C chip addresses are of the form 11110X₁0 (binary), where X₁ = 0, if ADDR pin is logic LOW; and X₁ = 1, if ADDR pin is logic HIGH. If the I²C interface is used to address a number of chips in a system, the LM49100's chip address can be changed to avoid any possible address conflicts.

The bus format for the I²C interface is shown in Figure 31. The bus format diagram is broken up into six major sections:

The "start" signal is generated by lowering the data signal while the clock signal is HIGH. The start signal will alert all devices attached to the I²C bus to check the incoming address against their own address.

The 8-bit chip address is sent next, most significant bit first. The data is latched in on the rising edge of the clock. Each address bit must be stable while the clock level is HIGH.

After the last bit of the address bit is sent, the master releases the data line HIGH (through a pull-up resistor). Then the master sends an acknowledge clock pulse. If the LM49100 has received the address correctly, then it holds the data line LOW during the clock pulse. If the data line is not held LOW during the acknowledge clock pulse, then the master should abort the rest of the data transfer to the LM49100.

The 8 bits of data are sent next, most significant bit first. Each data bit should be valid while the clock level is stable HIGH.

After the data byte is sent, the master must check for another acknowledge to see if the LM49100 received the data.

If the master has more data bytes to send to the LM49100, then the master can repeat the previous two steps until all data bytes have been sent.

The "stop" signal ends the transfer. To signal "stop", the data signal goes HIGH while the clock signal is HIGH. The data line should be held HIGH when not in use.

I²C INTERFACE POWER SUPPLY PIN (V_{DD}I²C)

The LM49100's I²C interface is powered up through the V_{DD} I²C pin. The LM49100's I²C interface operates at a voltage level set by the V_{DD} I²C pin which can be set independent to that of the main power supply pin V_{DD}. This is ideal whenever logic levels for the I²C interface are dictated by a microcontroller or microprocessor that is operating at a lower supply voltage than the main battery of a portable system.

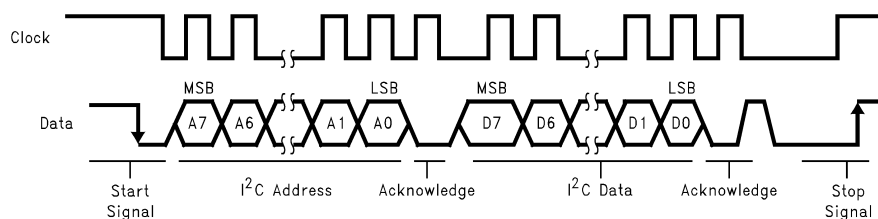

Figure 31. I²C Bus Format

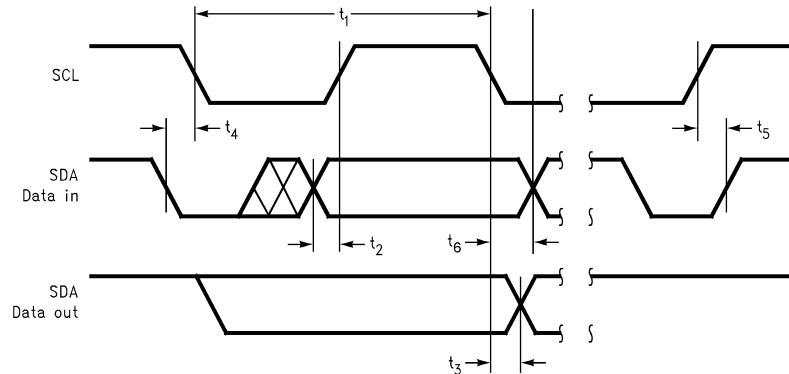

Figure 32. I²C Timing Diagram

PCB LAYOUT AND SUPPLY REGULATION CONSIDERATIONS FOR DRIVING 8Ω LOAD

Power dissipated by a load is a function of the voltage swing across the load and the load's impedance. As load impedance decreases, load dissipation becomes increasingly dependent on the interconnect (PCB trace and wire) resistance between the amplifier output pins and the load's connections. Residual trace resistance causes a voltage drop, which results in power dissipated in the trace and not in the load as desired. For example, 0.1Ω trace resistance reduces the output power dissipated by an 8Ω load from 158.3mW to 156.4mW. The problem of decreased load dissipation is exacerbated as load impedance decreases. Therefore, to maintain the highest load dissipation and widest output voltage swing, PCB traces that connect the output pins to a load must be as wide as possible.

Poor power supply regulation adversely affects maximum output power. A poorly regulated supply's output voltage decreases with increasing load current. Reduced supply voltage causes decreased headroom, output signal clipping, and reduced output power. Even with tightly regulated supplies, trace resistance creates the same effects as poor supply regulation. Therefore, making the power supply traces as wide as possible helps maintain full output voltage swing.

BRIDGE CONFIGURATION EXPLANATION

The LM49100 drives a load, such as a loudspeaker, connected between outputs, LS+ and LS-.

This results in both amplifiers producing signals identical in magnitude, but 180° out of phase. Taking advantage of this phase difference, a load is placed between LS- and LS+ and driven differentially (commonly referred to as "bridge mode").

Bridge mode amplifiers are different from single-ended amplifiers that drive loads connected between a single amplifier's output and ground. For a given supply voltage, bridge mode has a distinct advantage over the single-ended configuration: its differential output doubles the voltage swing across the load. Theoretically, this produces four times the output power when compared to a single-ended amplifier under the same conditions. This increase in attainable output power assumes that the amplifier is not current limited and that the output signal is not clipped.

Another advantage of the differential bridge output is no net DC voltage across the load. This is accomplished by biasing LS- and LS+ outputs at half-supply. This eliminates the coupling capacitor that single supply, single-ended amplifiers require. Eliminating an output coupling capacitor in a typical single-ended configuration forces a single-supply amplifier's half-supply bias voltage across the load. This increases internal IC power dissipation and may permanently damage loads such as loudspeakers.

POWER DISSIPATION

Power dissipation is a major concern when designing a successful single-ended or bridged amplifier.

A direct consequence of the increased power delivered to the load by a bridge amplifier is higher internal power dissipation. The LM49100 has a pair of bridged-tied amplifiers driving a handsfree loudspeaker, LS. The maximum internal power dissipation operating in the bridge mode is twice that of a single-ended amplifier. From [Equation 1](#), assuming a 5V power supply and an 8Ω load, the maximum MONO power dissipation is 634mW.

$$P_{\text{DMAX-LS}} = 4(V_{\text{DD}})^2 / (2\pi^2 R_L): \text{Bridge Mode} \quad (1)$$

The LM49100 also has a pair of single-ended amplifiers driving stereo headphones, HPR and HPL. The maximum internal power dissipation for HPR and HPL is given by [Equation 2](#). Assuming a 2.8V power supply and a 32Ω load, the maximum power dissipation for L_{OUT} and R_{OUT} is 49mW, or 99mW total.

$$P_{\text{DMAX-HPL}} = 4(V_{\text{DDHP}})^2 / (2\pi^2 R_L): \text{Single-ended Mode} \quad (2)$$

The maximum internal power dissipation of the LM49100 occurs when all three amplifiers pairs are simultaneously on; and is given by [Equation 3](#).

$$P_{\text{DMAX-TOTAL}} = P_{\text{DMAX-LS}} + P_{\text{DMAX-HPL}} + P_{\text{DMAX-HPR}} \quad (3)$$

The maximum power dissipation point given by [Equation 3](#) must not exceed the power dissipation given by [Equation 4](#):

$$P_{\text{DMAX}} = (T_{\text{JMAX}} - T_A) / \theta_{\text{JA}} \quad (4)$$

The LM49100's T_{JMAX} = 150°C. In the csBGA package, the LM49100's θ_{JA} is 50.2°C/W. At any given ambient temperature T_A, use [Equation 4](#) to find the maximum internal power dissipation supported by the IC packaging. Rearranging [Equation 4](#) and substituting P_{DMAX-TOTAL} for P_{DMAX} results in [Equation 5](#). This equation gives the maximum ambient temperature that still allows maximum stereo power dissipation without violating the LM49100's maximum junction temperature.

$$T_A = T_{\text{JMAX}} - P_{\text{DMAX-TOTAL}} \theta_{\text{JA}} \quad (5)$$

For a typical application with a 5V power supply and an 8Ω load, the maximum ambient temperature that allows maximum mono power dissipation without exceeding the maximum junction temperature is approximately 114°C for the csBGA package.

$$T_{\text{JMAX}} = P_{\text{DMAX-TOTAL}} \theta_{\text{JA}} + T_A \quad (6)$$

[Equation 6](#) gives the maximum junction temperature T_{JMAX}. If the result violates the LM49100's 150°C, reduce the maximum junction temperature by reducing the power supply voltage or increasing the load resistance. Further allowance should be made for increased ambient temperatures.

The above examples assume that a device is a surface mount part operating around the maximum power dissipation point. Since internal power dissipation is a function of output power, higher ambient temperatures are allowed as output power or duty cycle decreases. If the result of [Equation 3](#) is greater than that of [Equation 4](#), then decrease the supply voltage, increase the load impedance, or reduce the ambient temperature. If these measures are insufficient, a heat sink can be added to reduce θ_{JA}. The heat sink can be created using additional copper area around the package, with connections to the ground pin(s), supply pin and amplifier output pins.

POWER SUPPLY BYPASSING

As with any power amplifier, proper supply bypassing is critical for low noise performance and high power supply rejection. Applications that employ a 5V regulator typically use a 1μF in parallel with a 0.1μF filter capacitors to stabilize the regulator's output, reduce noise on the supply line, and improve the supply's transient response. However, their presence does not eliminate the need for a local 4.7μF tantalum bypass capacitor and a parallel 0.1μF ceramic capacitor connected between the LM49100's supply pin and ground. Keep the length of leads and traces that connect capacitors between the LM49100's power supply pin and ground as short as possible.

SELECTING EXTERNAL COMPONENTS

Input Capacitor Value Selection

Amplifying the lowest audio frequencies requires high value input coupling capacitor (C_{IN} in [Figure 1](#)). A high value capacitor can be expensive and may compromise space efficiency in portable designs. In many cases, however, the loudspeakers used in portable systems, whether internal or external, have little ability to reproduce signals below 150Hz. Applications using loudspeakers and headphones with this limited frequency response reap little improvement by using large input capacitor.

The internal input resistor (R_i), typical 12.5kΩ, and the input capacitor (C_{IN}) produce a high pass filter cutoff frequency that is found using [Equation 7](#).

$$f_c = 1 / (2\pi R_i C_{\text{IN}}) \quad (7)$$

Bypass Capacitor Value Selection

Besides minimizing the input capacitor size, careful consideration should be paid to value of C_B , the capacitor connected to the BYPASS pin. Since C_B determines how fast the LM49100 settles to quiescent operation, its value is critical when minimizing turn-on pops. Choosing C_B equal to 2.2 μ F along with a small value of C_i (in the range of 0.1 μ F to 0.33 μ F), produces a click-less and pop-less shutdown function. As discussed above, choosing C_{IN} no larger than necessary for the desired bandwidth helps minimize clicks and pops. C_B 's value should be in the range of 4 to 5 times the value of C_{IN} . This ensures that output transients are eliminated when power is first applied or the LM49100 resumes operation after shutdown.

Demo Board Schematic

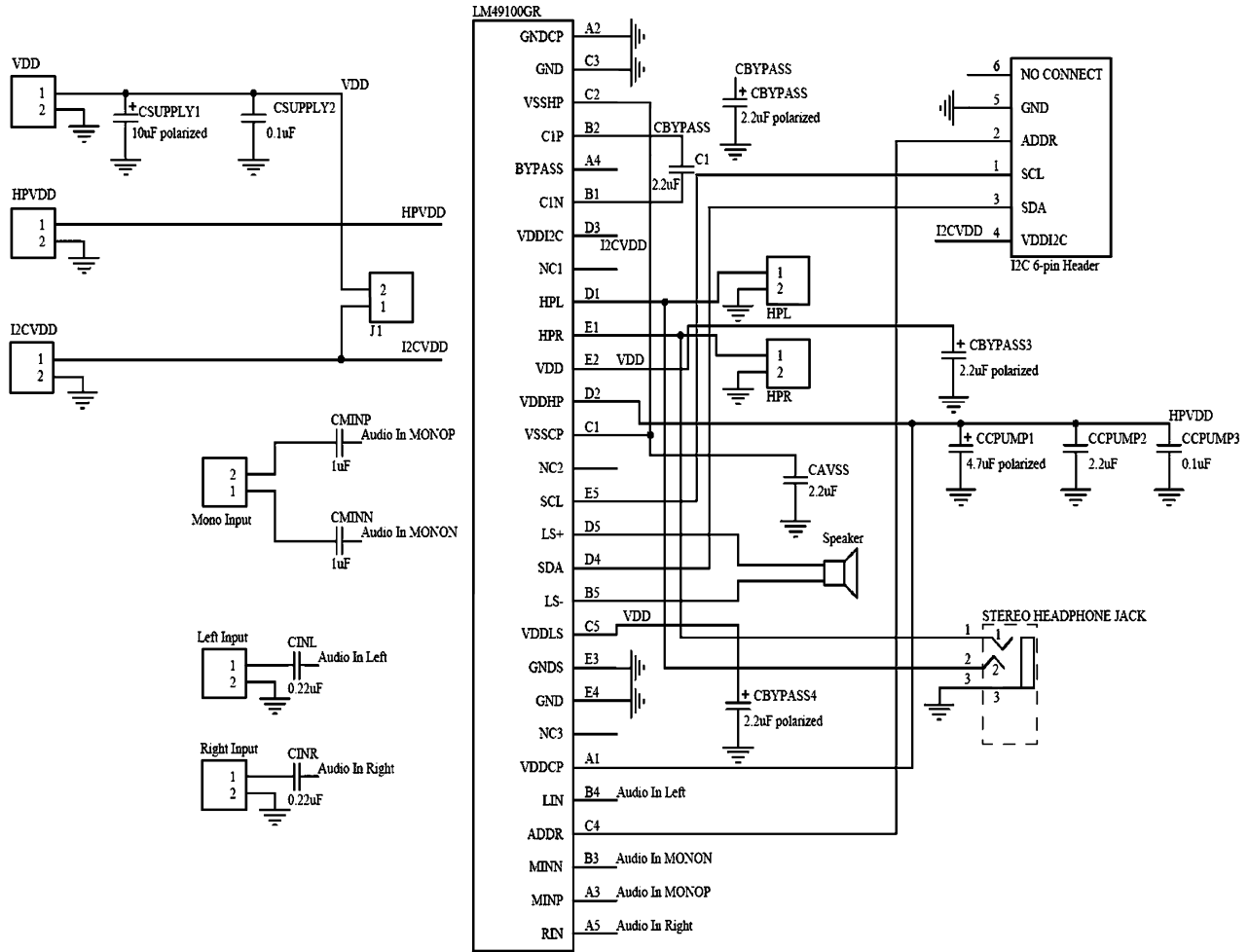

Figure 33. Demo Board Schematic

Demonstration Board Layout

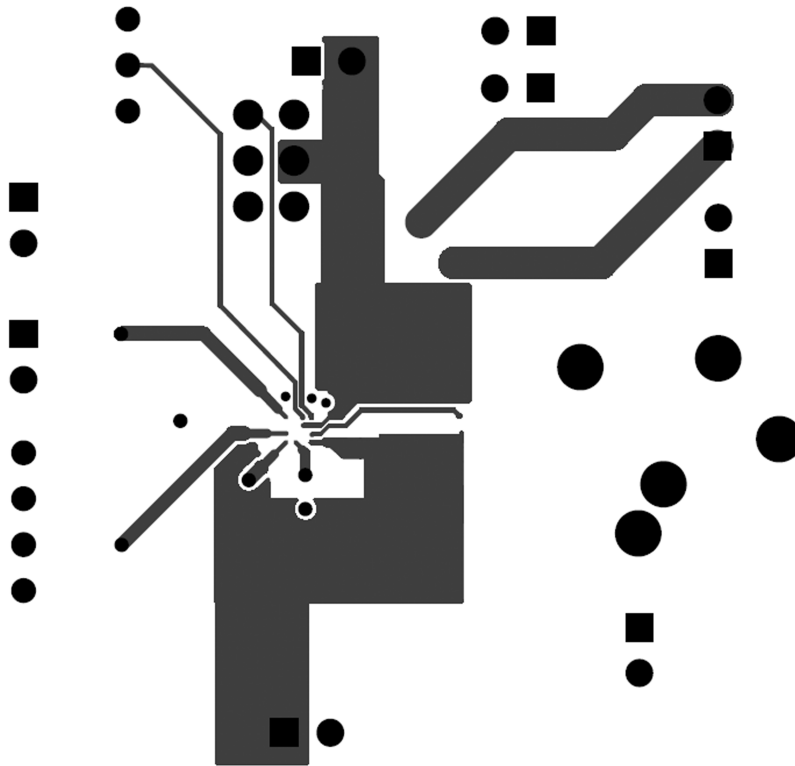

Figure 34. Signal 1 Layer

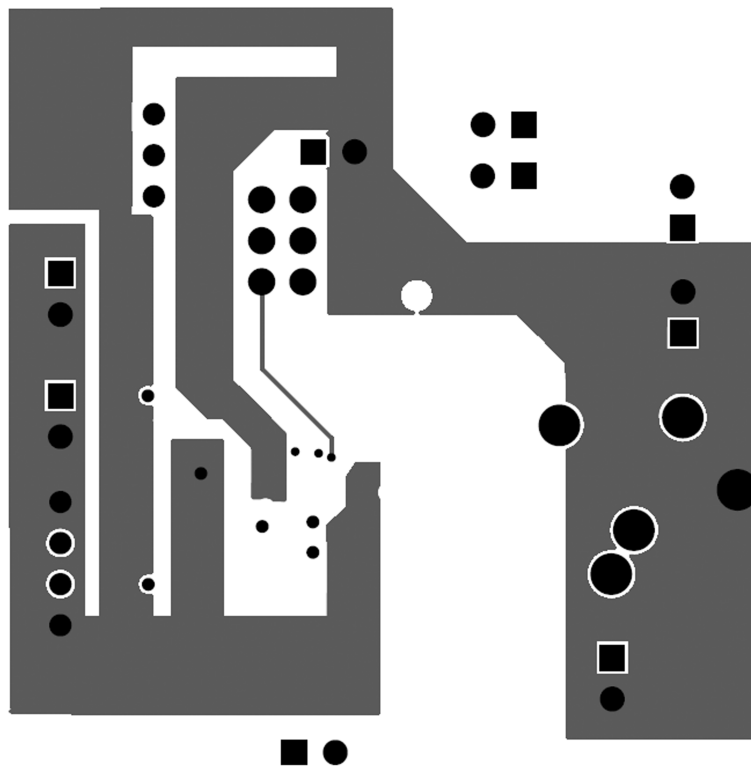

Figure 35. Signal 2 Layer

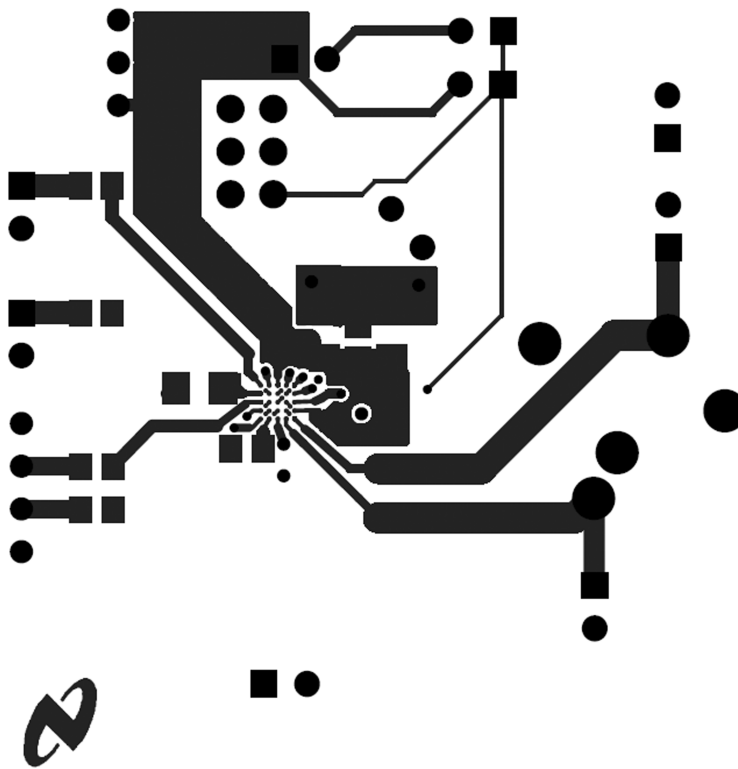

Figure 36. Top Layer

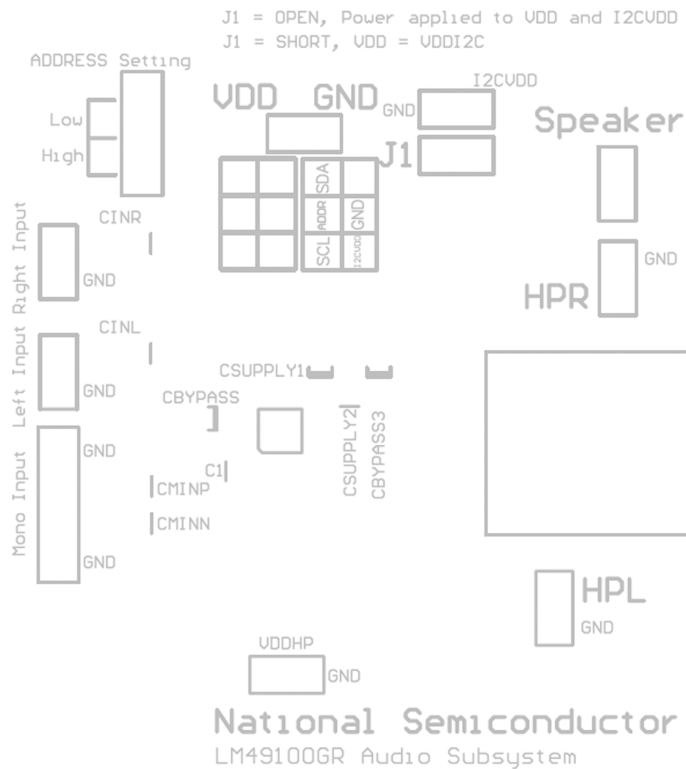

Figure 37. Top Overlay

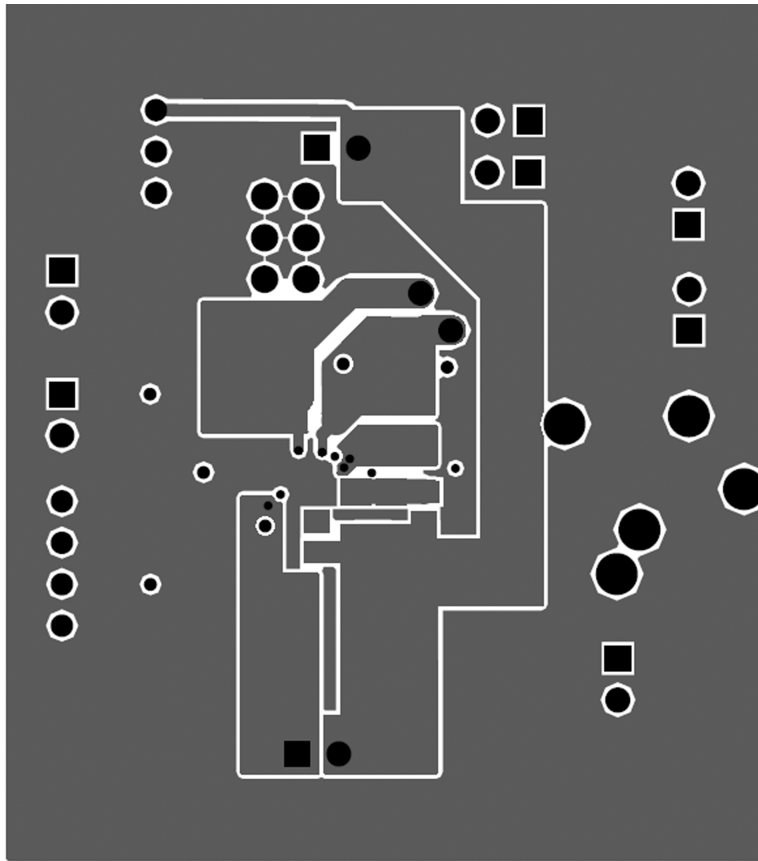

Figure 38. Bottom Layer



22101302E-001 Rev. A

Figure 39. Bottom Overlay

REVISION HISTORY

Rev	Date	Description
1.0	06/21/07	Initial release.
1.1	06/28/07	Changed the mktg outline from TLA25XXX to GRA25A.
1.2	08/09/07	Replaced some curves.
1.3	08/13/07	Changed the f = 1kHz into f = 217Hz (PSRR) in the Electrical Characteristics table.
1.4	08/14/07	Edited Table 1 .
1.5	09/18/07	Edited the Schematic Diagram .
F	05/02/2013	Changed layout of National Data Sheet to TI format.

PACKAGING INFORMATION

Orderable Device	Status (1)	Package Type	Package Drawing	Pins	Package Qty	Eco Plan (2)	Lead/Ball Finish (6)	MSL Peak Temp (3)	Op Temp (°C)	Device Marking (4/5)	Samples
LM49100GR/NOPB	ACTIVE	csBGA	NYA	25	1000	Green (RoHS & no Sb/Br)	CU SNAGCU	Level-1-260C-UNLIM	-40 to 85	GC9	Samples

(1) The marketing status values are defined as follows:

ACTIVE: Product device recommended for new designs.

LIFEBUY: TI has announced that the device will be discontinued, and a lifetime-buy period is in effect.

NRND: Not recommended for new designs. Device is in production to support existing customers, but TI does not recommend using this part in a new design.

PREVIEW: Device has been announced but is not in production. Samples may or may not be available.

OBSOLETE: TI has discontinued the production of the device.

(2) Eco Plan - The planned eco-friendly classification: Pb-Free (RoHS), Pb-Free (RoHS Exempt), or Green (RoHS & no Sb/Br) - please check <http://www.ti.com/productcontent> for the latest availability information and additional product content details.

TBD: The Pb-Free/Green conversion plan has not been defined.

Pb-Free (RoHS): TI's terms "Lead-Free" or "Pb-Free" mean semiconductor products that are compatible with the current RoHS requirements for all 6 substances, including the requirement that lead not exceed 0.1% by weight in homogeneous materials. Where designed to be soldered at high temperatures, TI Pb-Free products are suitable for use in specified lead-free processes.

Pb-Free (RoHS Exempt): This component has a RoHS exemption for either 1) lead-based flip-chip solder bumps used between the die and package, or 2) lead-based die adhesive used between the die and leadframe. The component is otherwise considered Pb-Free (RoHS compatible) as defined above.

Green (RoHS & no Sb/Br): TI defines "Green" to mean Pb-Free (RoHS compatible), and free of Bromine (Br) and Antimony (Sb) based flame retardants (Br or Sb do not exceed 0.1% by weight in homogeneous material)

(3) MSL, Peak Temp. - The Moisture Sensitivity Level rating according to the JEDEC industry standard classifications, and peak solder temperature.

(4) There may be additional marking, which relates to the logo, the lot trace code information, or the environmental category on the device.

(5) Multiple Device Markings will be inside parentheses. Only one Device Marking contained in parentheses and separated by a "~" will appear on a device. If a line is indented then it is a continuation of the previous line and the two combined represent the entire Device Marking for that device.

(6) Lead/Ball Finish - Orderable Devices may have multiple material finish options. Finish options are separated by a vertical ruled line. Lead/Ball Finish values may wrap to two lines if the finish value exceeds the maximum column width.

Important Information and Disclaimer: The information provided on this page represents TI's knowledge and belief as of the date that it is provided. TI bases its knowledge and belief on information provided by third parties, and makes no representation or warranty as to the accuracy of such information. Efforts are underway to better integrate information from third parties. TI has taken and continues to take reasonable steps to provide representative and accurate information but may not have conducted destructive testing or chemical analysis on incoming materials and chemicals. TI and TI suppliers consider certain information to be proprietary, and thus CAS numbers and other limited information may not be available for release.

In no event shall TI's liability arising out of such information exceed the total purchase price of the TI part(s) at issue in this document sold by TI to Customer on an annual basis.

TAPE AND REEL INFORMATION

QUADRANT ASSIGNMENTS FOR PIN 1 ORIENTATION IN TAPE

*All dimensions are nominal

Device	Package Type	Package Drawing	Pins	SPQ	Reel Diameter (mm)	Reel Width W1 (mm)	A0 (mm)	B0 (mm)	K0 (mm)	P1 (mm)	W (mm)	Pin1 Quadrant
LM49100GR/NOPB	csBGA	NYA	25	1000	178.0	12.4	3.3	3.3	1.6	8.0	12.0	Q1

TAPE AND REEL BOX DIMENSIONS



*All dimensions are nominal

Device	Package Type	Package Drawing	Pins	SPQ	Length (mm)	Width (mm)	Height (mm)
LM49100GR/NOPB	csBGA	NYA	25	1000	210.0	185.0	35.0

NYA0025A

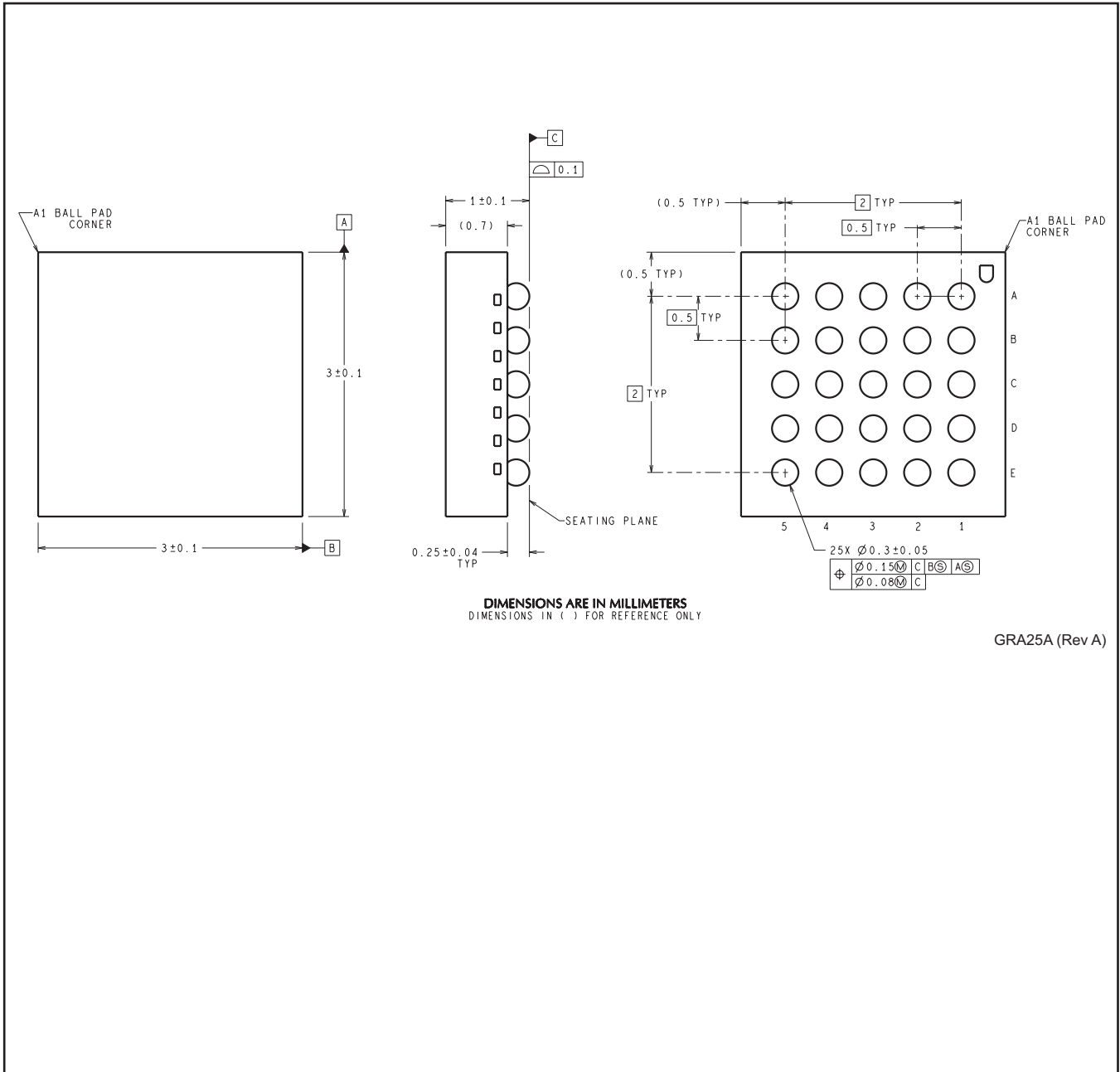

GRA25A (Rev A)

IMPORTANT NOTICE

Texas Instruments Incorporated and its subsidiaries (TI) reserve the right to make corrections, enhancements, improvements and other changes to its semiconductor products and services per JESD46, latest issue, and to discontinue any product or service per JESD48, latest issue. Buyers should obtain the latest relevant information before placing orders and should verify that such information is current and complete. All semiconductor products (also referred to herein as "components") are sold subject to TI's terms and conditions of sale supplied at the time of order acknowledgment.

TI warrants performance of its components to the specifications applicable at the time of sale, in accordance with the warranty in TI's terms and conditions of sale of semiconductor products. Testing and other quality control techniques are used to the extent TI deems necessary to support this warranty. Except where mandated by applicable law, testing of all parameters of each component is not necessarily performed.

TI assumes no liability for applications assistance or the design of Buyers' products. Buyers are responsible for their products and applications using TI components. To minimize the risks associated with Buyers' products and applications, Buyers should provide adequate design and operating safeguards.

TI does not warrant or represent that any license, either express or implied, is granted under any patent right, copyright, mask work right, or other intellectual property right relating to any combination, machine, or process in which TI components or services are used. Information published by TI regarding third-party products or services does not constitute a license to use such products or services or a warranty or endorsement thereof. Use of such information may require a license from a third party under the patents or other intellectual property of the third party, or a license from TI under the patents or other intellectual property of TI.

Reproduction of significant portions of TI information in TI data books or data sheets is permissible only if reproduction is without alteration and is accompanied by all associated warranties, conditions, limitations, and notices. TI is not responsible or liable for such altered documentation. Information of third parties may be subject to additional restrictions.

Resale of TI components or services with statements different from or beyond the parameters stated by TI for that component or service voids all express and any implied warranties for the associated TI component or service and is an unfair and deceptive business practice. TI is not responsible or liable for any such statements.

Buyer acknowledges and agrees that it is solely responsible for compliance with all legal, regulatory and safety-related requirements concerning its products, and any use of TI components in its applications, notwithstanding any applications-related information or support that may be provided by TI. Buyer represents and agrees that it has all the necessary expertise to create and implement safeguards which anticipate dangerous consequences of failures, monitor failures and their consequences, lessen the likelihood of failures that might cause harm and take appropriate remedial actions. Buyer will fully indemnify TI and its representatives against any damages arising out of the use of any TI components in safety-critical applications.

In some cases, TI components may be promoted specifically to facilitate safety-related applications. With such components, TI's goal is to help enable customers to design and create their own end-product solutions that meet applicable functional safety standards and requirements. Nonetheless, such components are subject to these terms.

No TI components are authorized for use in FDA Class III (or similar life-critical medical equipment) unless authorized officers of the parties have executed a special agreement specifically governing such use.

Only those TI components which TI has specifically designated as military grade or "enhanced plastic" are designed and intended for use in military/aerospace applications or environments. Buyer acknowledges and agrees that any military or aerospace use of TI components which have **not** been so designated is solely at the Buyer's risk, and that Buyer is solely responsible for compliance with all legal and regulatory requirements in connection with such use.

TI has specifically designated certain components as meeting ISO/TS16949 requirements, mainly for automotive use. In any case of use of non-designated products, TI will not be responsible for any failure to meet ISO/TS16949.

Products

Audio	www.ti.com/audio
Amplifiers	amplifier.ti.com
Data Converters	dataconverter.ti.com
DLP® Products	www.dlp.com
DSP	dsp.ti.com
Clocks and Timers	www.ti.com/clocks
Interface	interface.ti.com
Logic	logic.ti.com
Power Mgmt	power.ti.com
Microcontrollers	microcontroller.ti.com
RFID	www.ti-rfid.com
OMAP Applications Processors	www.ti.com/omap
Wireless Connectivity	www.ti.com/wirelessconnectivity

Applications

Automotive and Transportation	www.ti.com/automotive
Communications and Telecom	www.ti.com/communications
Computers and Peripherals	www.ti.com/computers
Consumer Electronics	www.ti.com/consumer-apps
Energy and Lighting	www.ti.com/energy
Industrial	www.ti.com/industrial
Medical	www.ti.com/medical
Security	www.ti.com/security
Space, Avionics and Defense	www.ti.com/space-avionics-defense
Video and Imaging	www.ti.com/video

TI E2E Community

e2e.ti.com