

TPD1E0B04 1-Channel ESD Protection Diode for USB Type-C and Antenna Protection

1 Features

- IEC 61000-4-2 Level 4 (Contact) ESD Protection
 - ± 8 -kV Contact Discharge
 - ± 9 -kV Air Gap Discharge
- IEC 61000-4-4 EFT Protection
 - 80 A (5/50 ns)
- IEC 61000-4-5 Surge Protection
 - 1.7 A (8/20 μ s)
- IO Capacitance: 0.13 pF (Typical), 0.15 pF (Maximum)
- DC Breakdown Voltage: 6.7 V (Typical)
- Ultra Low Leakage Current: 10 nA (Maximum)
- Low ESD Clamping Voltage
- Supports High Speed Interfaces up to 20 Gbps
- Low Insertion Loss: >30 GHz (–3 dB Bandwidth)
- Industrial Temperature Range: -40°C to $+125^{\circ}\text{C}$
- Ultra-small 0201 footprint

2 Applications

- End Equipment
 - Laptops and Desktops
 - Mobile and Tablets
 - Set-Top Boxes
 - TV and Monitors
 - USB Dongles
 - Docking Stations
- Interfaces
 - USB Type-C
 - Thunderbolt 3
 - USB 3.1 Gen 2
 - HDMI 2.0/1.4
 - USB 3.0
 - DisplayPort 1.3
 - PCI Express 3.0
 - Antenna

3 Description

The TPD1E0B04 is a bidirectional TVS ESD protection diode array for USB Type-C and Thunderbolt 3 circuit protection. The TPD1E0B04 is rated to dissipate ESD strikes at the maximum level specified in the IEC 61000-4-2 international standard (Level 4).

This device features a 0.13-pF IO capacitance per channel making it ideal for protecting high-speed interfaces up to 20 Gbps such as USB 3.1 Gen2, Thunderbolt 3, and Antenna. The low dynamic resistance and low clamping voltage ensure system level protection against transient events.

The TPD1E0B04 is offered in the industry standard 0201 (DPL) package.

Device Information⁽¹⁾

PART NUMBER	PACKAGE	BODY SIZE (NOM)
TPD1E0B04	X2SON (2)	0.60 mm x 0.30 mm

(1) For all available packages, see the orderable addendum at the end of the data sheet.

Typical Application

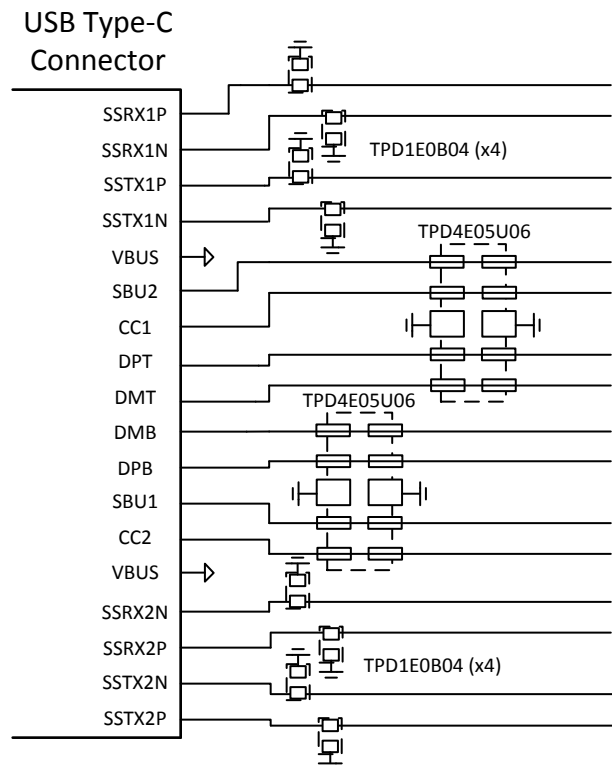

Table of Contents

1 Features	1	7.4 Device Functional Modes.....	9
2 Applications	1	8 Application and Implementation	10
3 Description	1	8.1 Application Information.....	10
4 Revision History	2	8.2 Typical Applications	10
5 Pin Configuration and Functions	3	9 Power Supply Recommendations	14
6 Specifications	4	10 Layout	14
6.1 Absolute Maximum Ratings	4	10.1 Layout Guidelines	14
6.2 ESD Ratings	4	10.2 Layout Example	14
6.3 ESD Ratings—IEC Specification	4	11 Device and Documentation Support	15
6.4 Recommended Operating Conditions.....	4	11.1 Documentation Support	15
6.5 Thermal Information	4	11.2 Receiving Notification of Documentation Updates	15
6.6 Electrical Characteristics.....	5	11.3 Community Resources.....	15
6.7 Typical Characteristics.....	6	11.4 Trademarks	15
7 Detailed Description	8	11.5 Electrostatic Discharge Caution.....	15
7.1 Overview	8	11.6 Glossary	15
7.2 Functional Block Diagram	8	12 Mechanical, Packaging, and Orderable	15
7.3 Feature Description.....	8	Information	15

4 Revision History

Changes from Original (March 2016) to Revision A

Page

• Changed device status from <i>Product Preview</i> to <i>Production Data</i>	1
---	----------

5 Pin Configuration and Functions

**DPL Package
2-Pin X2SON
Top View**

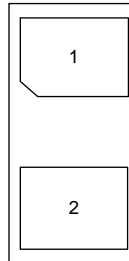

**DPY Package
2-Pin X1SON
Top View**

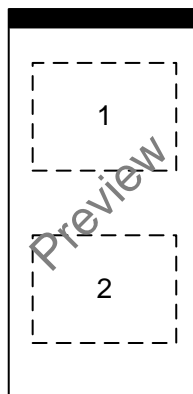

Pin Functions

PIN		I/O	DESCRIPTION
NO.	NAME		
1	IO	I/O	ESD Protected Channel. If used as ESD IO, connect pin 2 to ground
2	IO	I/O	ESD Protected Channel. If used as ESD IO, connect pin 1 to ground

6 Specifications

6.1 Absolute Maximum Ratings

over operating free-air temperature range (unless otherwise noted)⁽¹⁾

		MIN	MAX	UNIT
Electrical fast transient	IEC 61000-4-5 (5/50 ns)		80	A
Peak pulse	IEC 61000-4-5 power ($t_p - 8/20 \mu\text{s}$)		15	W
	IEC 61000-4-5 current ($t_p - 8/20 \mu\text{s}$)		1.7	A
T_A	Operating free-air temperature	-40	125	°C
T_{stg}	Storage temperature	-65	155	°C

(1) Stresses beyond those listed under *Absolute Maximum Ratings* may cause permanent damage to the device. These are stress ratings only, which do not imply functional operation of the device at these or any other conditions beyond those indicated under *Recommended Operating Conditions*. Exposure to absolute-maximum-rated conditions for extended periods may affect device reliability.

6.2 ESD Ratings

		VALUE	UNIT
$V_{\text{(ESD)}}$ Electrostatic discharge	Human-body model (HBM), per ANSI/ESDA/JEDEC JS-001 ⁽¹⁾	±2500	V
	Charged-device model (CDM), per JEDEC specification JESD22-C101 ⁽²⁾	±1000	

(1) JEDEC document JEP155 states that 500-V HBM allows safe manufacturing with a standard ESD control process.

(2) JEDEC document JEP157 states that 250-V CDM allows safe manufacturing with a standard ESD control process.

6.3 ESD Ratings—IEC Specification

		VALUE	UNIT
$V_{\text{(ESD)}}$ Electrostatic discharge	IEC 61000-4-2 contact discharge	±8000	V
	IEC 61000-4-2 air-gap discharge	±9000	

6.4 Recommended Operating Conditions

over operating free-air temperature range (unless otherwise noted)

		MIN	MAX	UNIT
V_{IO}	Input pin voltage	-3.6	3.6	V
T_A	Operating free-air temperature	-40	125	°C

6.5 Thermal Information

THERMAL METRIC ⁽¹⁾		TPD1E0B04	UNIT
		DPL (X2SON)	
		2 PINS	
$R_{\theta\text{JA}}$	Junction-to-ambient thermal resistance	582	°C/W
$R_{\theta\text{JC(top)}}$	Junction-to-case (top) thermal resistance	264.5	°C/W
$R_{\theta\text{JB}}$	Junction-to-board thermal resistance	394.4	°C/W
Ψ_{JT}	Junction-to-top characterization parameter	36.4	°C/W
Ψ_{JB}	Junction-to-board characterization parameter	394.4	°C/W
$R_{\theta\text{JC(bot)}}$	Junction-to-case (bottom) thermal resistance	n/a	°C/W

(1) For more information about traditional and new thermal metrics, see the [Semiconductor and IC Package Thermal Metrics](#) application report.

6.6 Electrical Characteristics

over operating free-air temperature range (unless otherwise noted)

PARAMETER		TEST CONDITIONS	MIN	TYP	MAX	UNIT
V_{RWM}	Reverse stand-off voltage	$I_{IO} < 10 \text{ nA}$	-3.6		3.6	V
V_{BRF}	Breakdown voltage, IO pin to GND	Measured as the maximum voltage before device snaps back into V_{HOLD} voltage		6.7		V
V_{BRR}	Breakdown voltage, GND to IO pin	Measured as the maximum voltage before device snaps back into V_{HOLD} voltage		-6.7		V
V_{HOLD}	Holding voltage	$I_{IO} = 1 \text{ mA}$, $T_A = 25^\circ\text{C}$	5	5.7	6.5	V
V_{CLAMP}	Clamping voltage	$I_{PP} = 1 \text{ A}$, TLP, from IO to GND		7.2		V
		$I_{PP} = 5 \text{ A}$, TLP, from IO to GND		10.1		
		$I_{PP} = 16 \text{ A}$, TLP, from IO to GND		19		
		$I_{PP} = 1 \text{ A}$, TLP, from GND to IO		7.2		
		$I_{PP} = 5 \text{ A}$, TLP, from GND to IO		10.1		
		$I_{PP} = 16 \text{ A}$, TLP, from GND to IO		19		
I_{LEAK}	Leakage current, IO to GND	$V_{IO} = \pm 2.5 \text{ V}$			10	nA
R_{DYN}	Dynamic resistance	IO to GND		1		Ω
		GND to IO		1		
C_L	Line capacitance	$V_{IO} = 0 \text{ V}$, $f = 1 \text{ MHz}$, IO to GND $T_A = 25^\circ\text{C}$		0.13	0.15	pF

6.7 Typical Characteristics

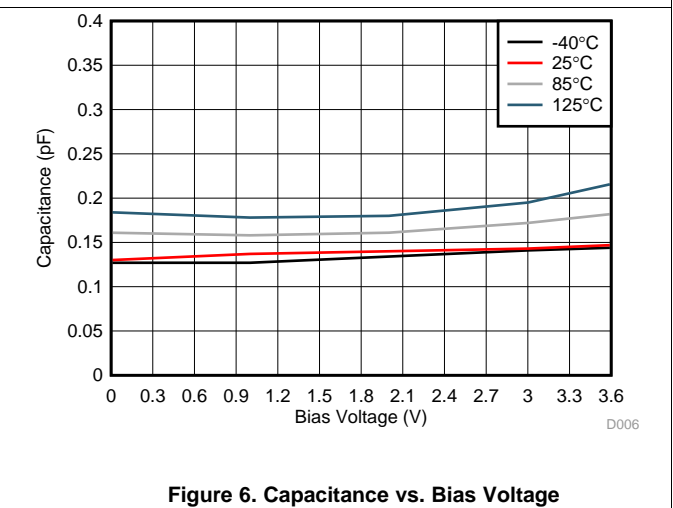
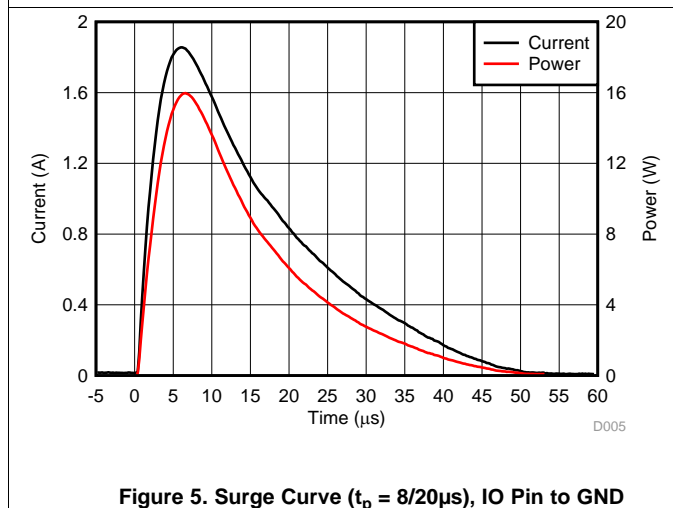
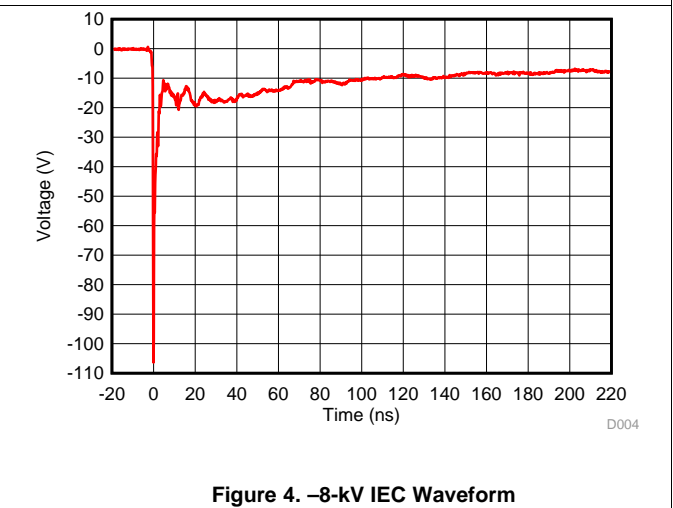
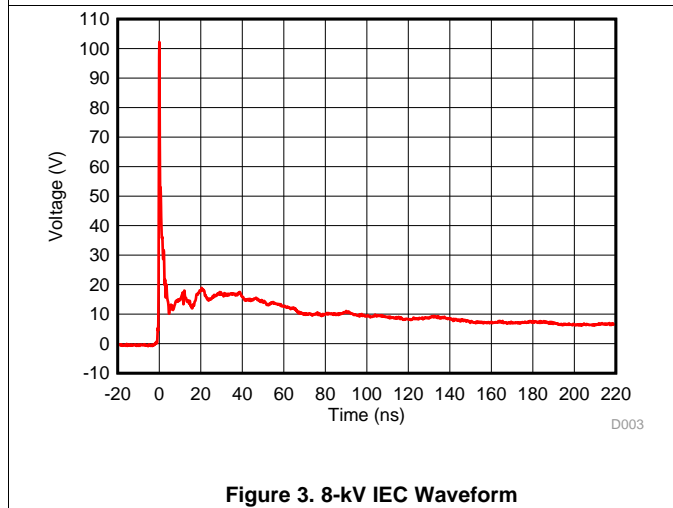
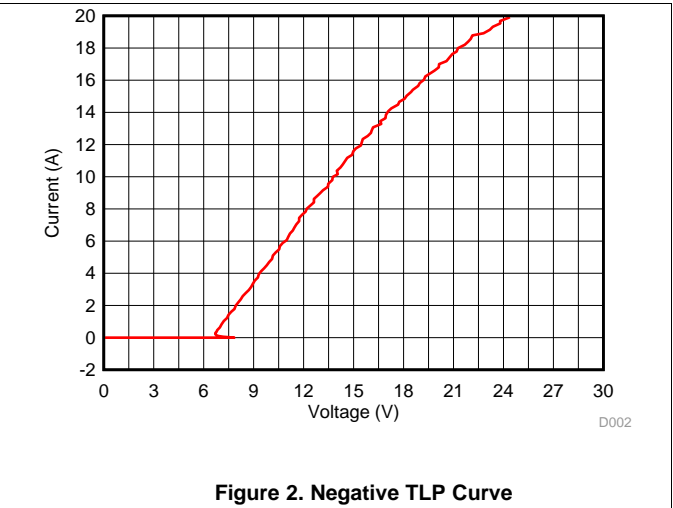
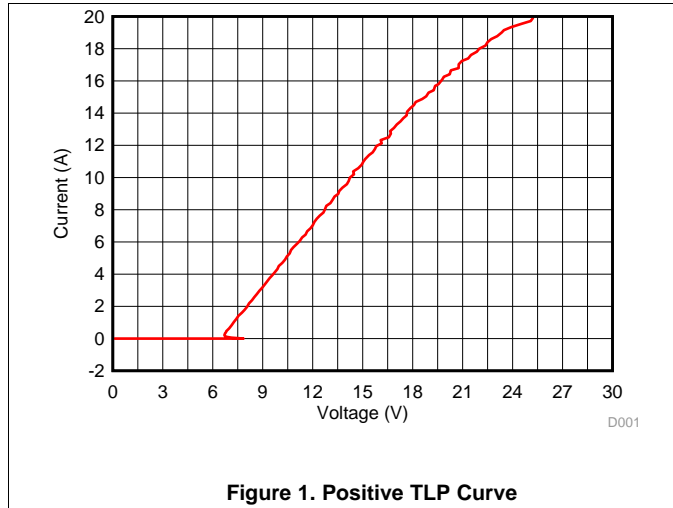

Typical Characteristics (continued)

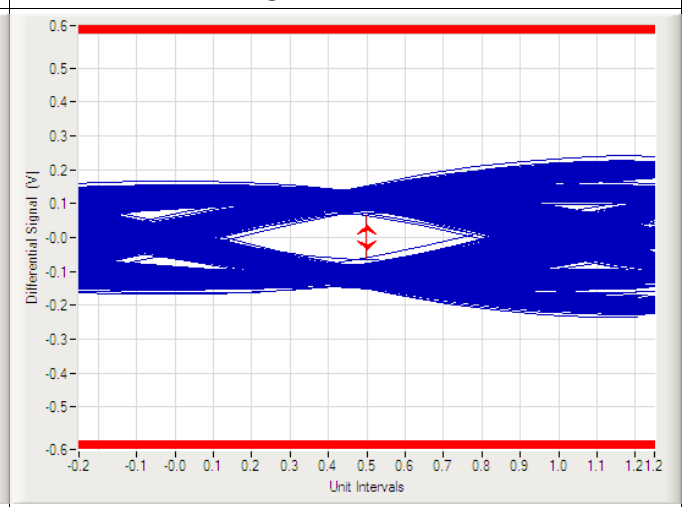
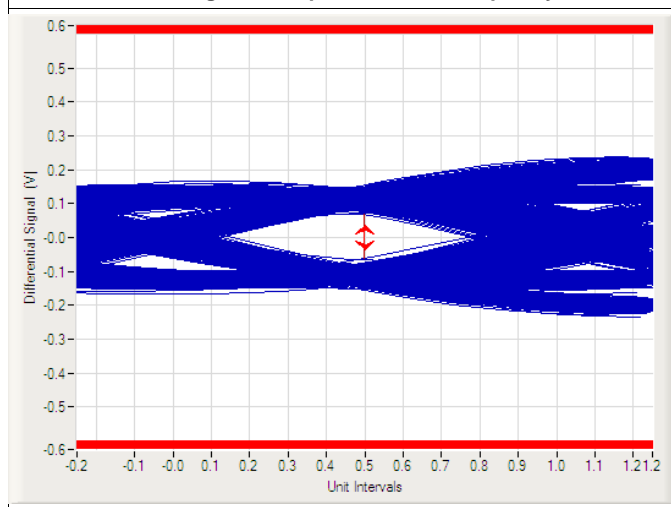
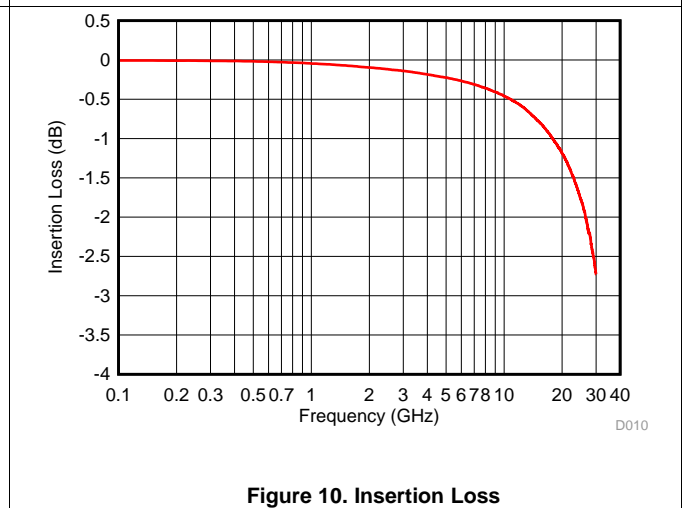
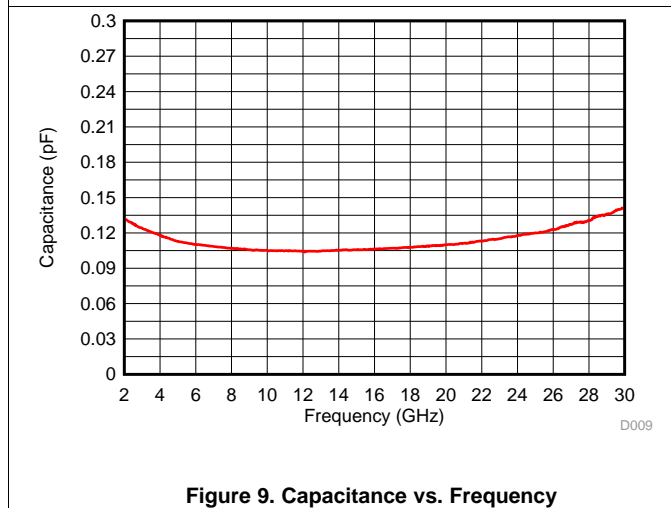
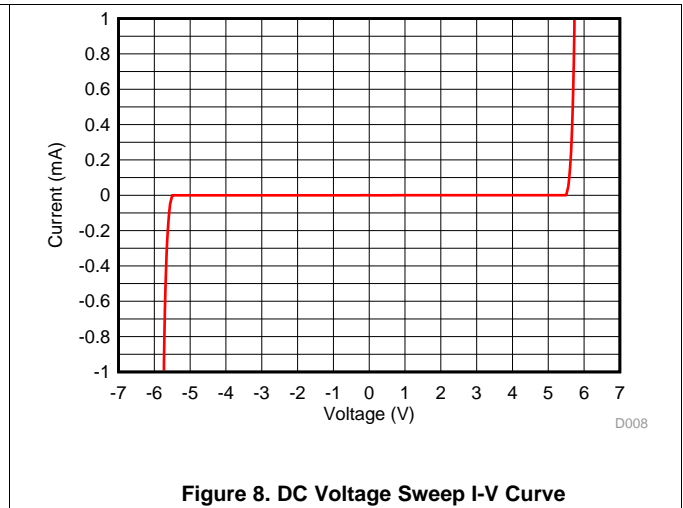
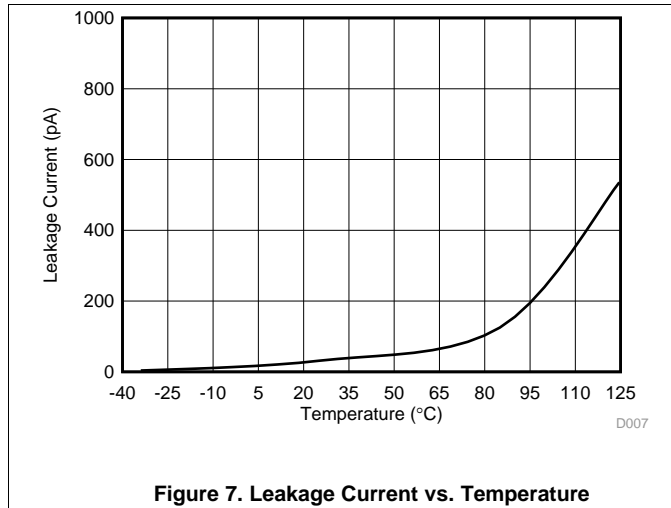

7 Detailed Description

7.1 Overview

The TPD1E0B04 device is a bidirectional ESD Protection Diode with ultra-low capacitance. This device can dissipate ESD strikes at the maximum level specified by the IEC 61000-4-2 International Standard (contact). The ultra-low capacitance makes this device ideal for protecting any super high-speed signal pins including Thunderbolt 3. The low capacitance allows for extremely low losses even at RF frequencies such as USB 3.1 Gen 2, Thunderbolt 3, or antenna applications.

7.2 Functional Block Diagram

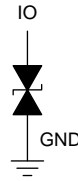

Copyright © 2016, Texas Instruments Incorporated

7.3 Feature Description

7.3.1 IEC 61000-4-2 ESD Protection

The I/O pins can withstand ESD events up to ± 8 -kV contact and ± 9 -kV air gap. An ESD-surge clamp diverts the current to ground.

7.3.2 IEC 61000-4-4 EFT Protection

The I/O pins can withstand an electrical fast transient burst of up to 80 A (5/50 ns waveform, 4 kV with 50- Ω impedance). An ESD-surge clamp diverts the current to ground.

7.3.3 IEC 61000-4-5 Surge Protection

The I/O pins can withstand surge events up to 1.7 A and 15 W (8/20 μ s waveform). An ESD-surge clamp diverts this current to ground.

7.3.4 IO Capacitance

The capacitance between each I/O pin to ground is 0.13 pF (typical) and 0.15 pF (maximum). This device supports data rates in excess of 20 Gbps.

7.3.5 DC Breakdown Voltage

The DC breakdown voltage of each I/O pin is ± 6.7 V (typical). This ensures that sensitive equipment is protected from surges above the reverse standoff voltage of ± 3.6 V.

7.3.6 Ultra Low Leakage Current

The I/O pins feature an ultra-low leakage current of 10 nA (maximum) with a bias of ± 2.5 V

7.3.7 Low ESD Clamping Voltage

The I/O pins feature an ESD clamp that is capable of clamping the voltage to 10.1 V ($I_{PP} = 5$ A).

7.3.8 Supports High Speed Interfaces

This device is capable of supporting high speed interfaces in excess of 20 Gbps, because of the extremely low IO capacitance.

7.3.9 Industrial Temperature Range

This device features an industrial operating range of -40°C to $+125^{\circ}\text{C}$.

Feature Description (continued)

7.3.10 Industry Standard Package

The layout of this device makes it simple and easy to add protection to an existing layout. The package is offered in industry standard 0201 footprint, requiring minimal modification to an existing layout.

7.4 Device Functional Modes

The TPD1E0B04 device is a passive integrated circuit that triggers when voltages are above V_{BRF} or below V_{BRR} . During ESD events, voltages as high as ± 9 kV (air) can be directed to ground via the internal diode network. When the voltages on the protected line fall below the trigger levels of TPD1E0B04 (usually within 10s of nanoseconds) the device reverts to passive.

8 Application and Implementation

NOTE

Information in the following applications sections is not part of the TI component specification, and TI does not warrant its accuracy or completeness. TI's customers are responsible for determining suitability of components for their purposes. Customers should validate and test their design implementation to confirm system functionality.

8.1 Application Information

The TPD1E0B04 is a diode type TVS which is used to provide a path to ground for dissipating ESD events on high-speed signal lines between a human interface connector and a system. As the current from ESD passes through the TVS, only a small voltage drop is present across the diode. This is the voltage presented to the protected IC. The low R_{DYN} of the triggered TVS holds this voltage, V_{CLAMP} , to a safe level for the protected IC.

8.2 Typical Applications

8.2.1 USB Type-C Application

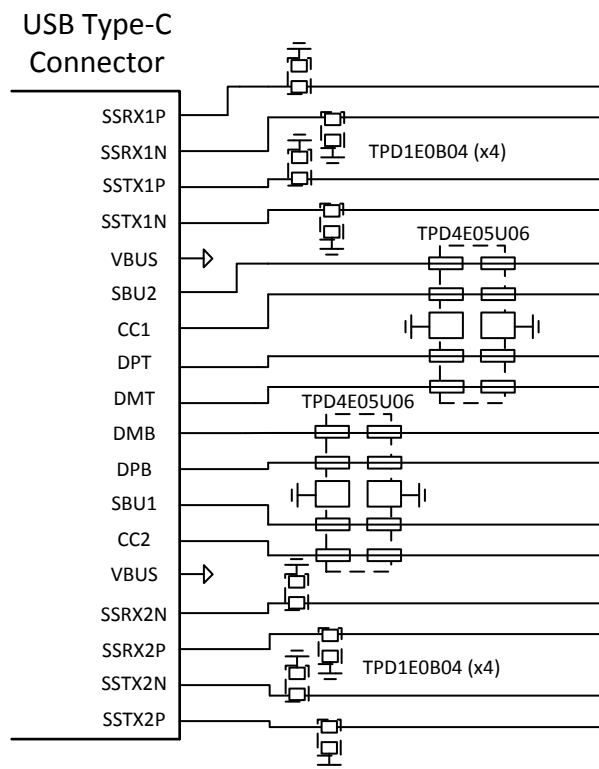

Figure 13. USB Type-C for Thunderbolt 3 ESD Schematic

8.2.1.1 Design Requirements

For this design example eight TPD1E0B04 devices and two TPD4E05U06 devices are being used in a USB Type-C for Thunderbolt 3 application. This provides a complete ESD protection scheme.

Given the Thunderbolt 3 application, the parameters listed in [Table 1](#) are known.

Table 1. Design Parameters

DESIGN PARAMETER	VALUE
Signal range on superspeed Lines	0 V to 3.6 V
Operating frequency on superspeed Lines	up to 10 GHz
Signal range on CC, SBU, and DP/DM Lines	0 V to 5 V
Operating frequency on CC, SBU, and DP/DM Lines	up to 480 MHz

8.2.1.2 Detailed Design Procedure

8.2.1.2.1 Signal Range

The TPD1E0B04 supports signal ranges between -3.6 V and 3.6 V , which supports the SuperSpeed pairs on the USB Type-C application. The TPD4E05U06 supports signal ranges between 0 V and 5.5 V , which supports the CC, SBU, and DP-DM lines.

8.2.1.2.2 Operating Frequency

The TPD1E0B04 has a 0.13 pF (typical) capacitance, which supports the Thunderbolt 3 data rates of 20 Gbps . The TPD4E05U06 has a 0.5-pF (typical) capacitance, which easily supports the CC, SBU, and DP-DM data rates.

8.2.1.3 Application Curves

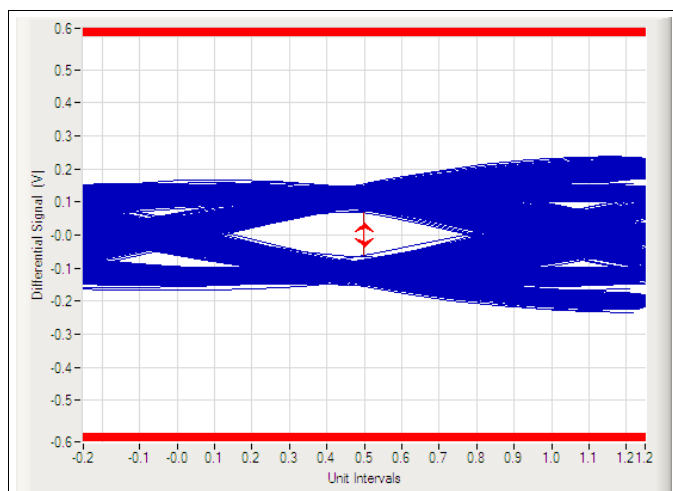

Figure 14. USB 3.1 Gen 2 10-Gbps Eye Diagram (Bare Board)

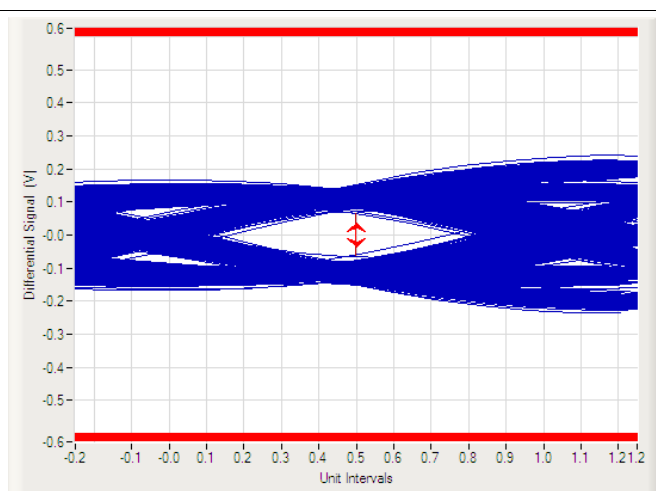
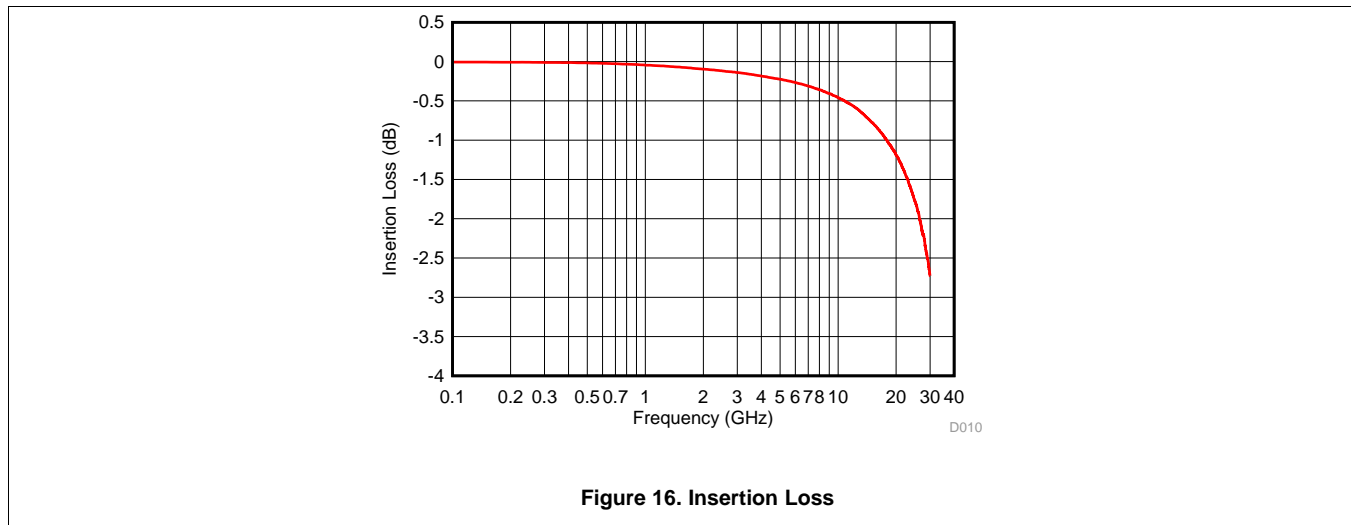

Figure 15. USB 3.1 Gen 2 10-Gbps Eye Diagram (with TPD1E0B04)



8.2.2 WiFi Antenna Application

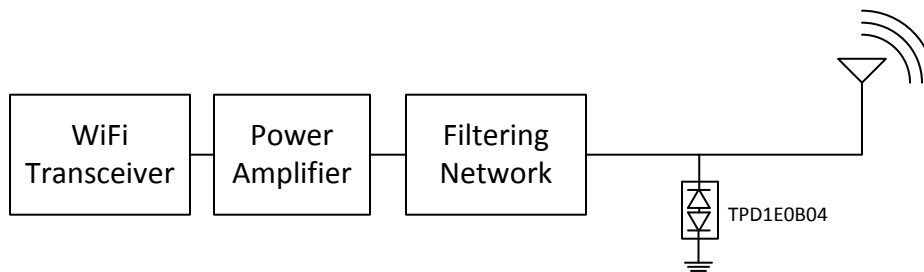

Figure 17. WiFi Antenna Schematic

8.2.2.1 Design Requirements

For this design example one TPD1E0B04 device for a 5-GHz WiFi antenna application. This provides a complete ESD protection scheme.

Given the WiFi antenna application, the parameters listed in [Table 2](#) are known.

Table 2. Design Parameters

DESIGN PARAMETER	VALUE
Signal range	-3.16 V to +3.16 V
Operating frequency	5.170 GHz to 5.835 GHz

8.2.2.2 Detailed Design Procedure

8.2.2.2.1 Signal Range

The TPD1E0B04 supports signal ranges between -3.6 V and 3.6 V, which supports the antenna signal range. The signal range shown assumes maximum transmit power of 200 mW into a 50-Ω antenna.

8.2.2.2.2 Operating Frequency

The TPD1E0B04 has a 0.13 pF (typical) capacitance, which supports extremely high data rates. The capacitance vs. frequency and bias voltages are exceedingly low, allowing for very low RF loss and known impedance characteristics. Since capacitance and loss changes very little across the operating frequencies, there must be minimal disturbance on the line.

8.2.2.3 Application Curves

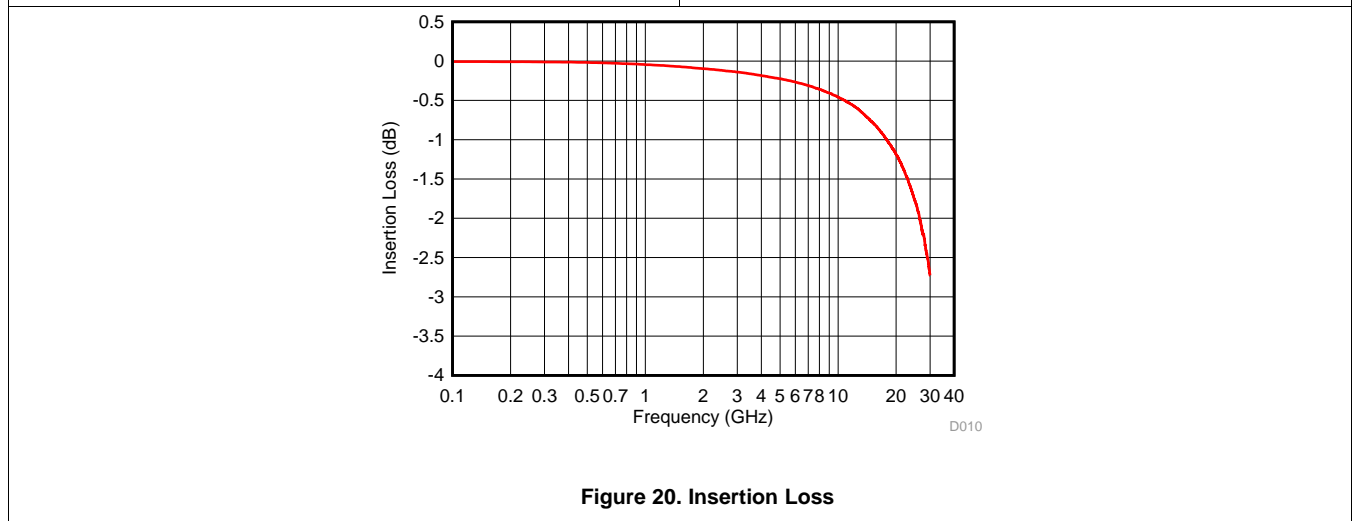
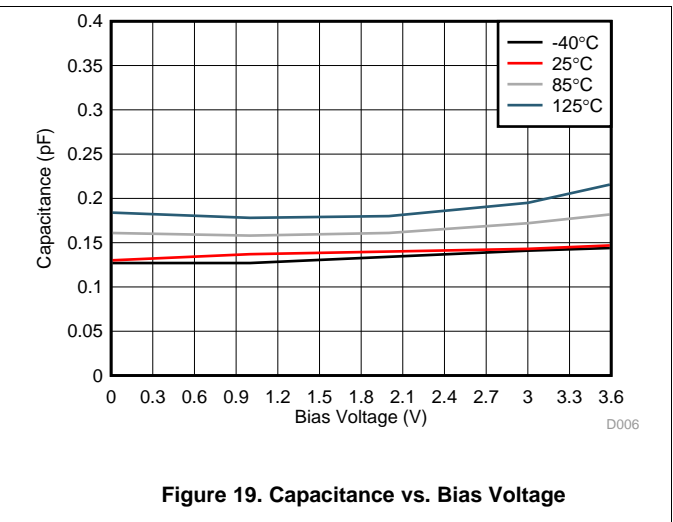
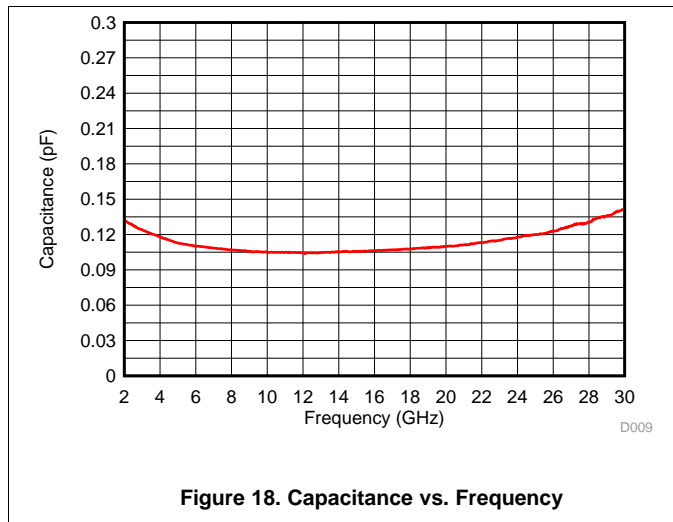

9 Power Supply Recommendations

This device is a passive ESD device so there is no need to power it. Take care not to violate the recommended I/O specification to ensure the device functions properly.

10 Layout

10.1 Layout Guidelines

- The optimum placement is as close to the connector as possible.
 - EMI during an ESD event can couple from the trace being struck to other nearby unprotected traces, resulting in early system failures.
 - The PCB designer must minimize the possibility of EMI coupling by keeping any unprotected traces away from the protected traces which are between the TVS and the connector.
- Route the protected traces as straight as possible.
- Eliminate any sharp corners on the protected traces between the TVS and the connector by using rounded corners with the largest radii possible.
 - Electric fields tend to build up on corners, increasing EMI coupling.

10.2 Layout Example

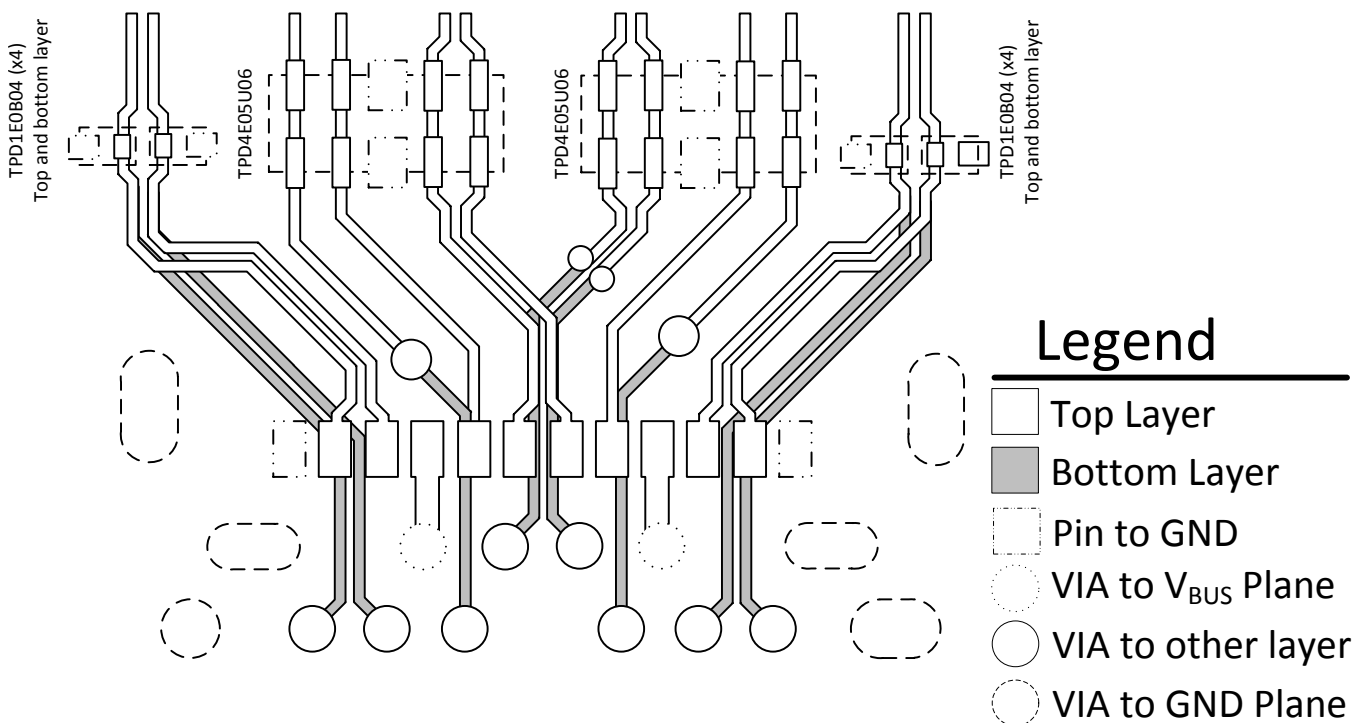

Figure 21. USB Type-C Mid-Mount, Hybrid Connector ESD Layout

11 Device and Documentation Support

11.1 Documentation Support

11.1.1 Related Documentation

For related documentation see the following:

TPD1E0B04 Evaluation Module User's Guide, [SLVUAN6](#)

11.2 Receiving Notification of Documentation Updates

To receive notification of documentation updates, navigate to the device product folder on [ti.com](#). In the upper right corner, click on *Alert me* to register and receive a weekly digest of any product information that has changed. For change details, review the revision history included in any revised document.

11.3 Community Resources

The following links connect to TI community resources. Linked contents are provided "AS IS" by the respective contributors. They do not constitute TI specifications and do not necessarily reflect TI's views; see TI's [Terms of Use](#).

TI E2E™ Online Community *TI's Engineer-to-Engineer (E2E) Community*. Created to foster collaboration among engineers. At [e2e.ti.com](#), you can ask questions, share knowledge, explore ideas and help solve problems with fellow engineers.

Design Support *TI's Design Support* Quickly find helpful E2E forums along with design support tools and contact information for technical support.

11.4 Trademarks

E2E is a trademark of Texas Instruments.

All other trademarks are the property of their respective owners.

11.5 Electrostatic Discharge Caution



This integrated circuit can be damaged by ESD. Texas Instruments recommends that all integrated circuits be handled with appropriate precautions. Failure to observe proper handling and installation procedures can cause damage.

ESD damage can range from subtle performance degradation to complete device failure. Precision integrated circuits may be more susceptible to damage because very small parametric changes could cause the device not to meet its published specifications.

11.6 Glossary

[SLYZ022](#) — *TI Glossary*.

This glossary lists and explains terms, acronyms, and definitions.

12 Mechanical, Packaging, and Orderable Information

The following pages include mechanical, packaging, and orderable information. This information is the most current data available for the designated devices. This data is subject to change without notice and revision of this document. For browser-based versions of this data sheet, refer to the left-hand navigation.

PACKAGING INFORMATION

Orderable Device	Status (1)	Package Type	Package Drawing	Pins	Package Qty	Eco Plan (2)	Lead/Ball Finish (6)	MSL Peak Temp (3)	Op Temp (°C)	Device Marking (4/5)	Samples
TPD1E0B04DPLR	ACTIVE	X2SON	DPL	2	15000	Green (RoHS & no Sb/Br)	CU NIPDAU	Level-1-260C-UNLIM	-40 to 125	8	Samples
TPD1E0B04DPLT	ACTIVE	X2SON	DPL	2	250	Green (RoHS & no Sb/Br)	CU NIPDAU	Level-1-260C-UNLIM	-40 to 125	8	Samples
TPD1E0B04DPYR	PREVIEW	X1SON	DPY	2	10000	Green (RoHS & no Sb/Br)	CU NIPDAU	Level-1-260C-UNLIM	-40 to 125	5D	
TPD1E0B04DPYT	PREVIEW	X1SON	DPY	2	250	Green (RoHS & no Sb/Br)	CU NIPDAU	Level-1-260C-UNLIM	-40 to 125	5D	

(1) The marketing status values are defined as follows:

ACTIVE: Product device recommended for new designs.

LIFEBUY: TI has announced that the device will be discontinued, and a lifetime-buy period is in effect.

NRND: Not recommended for new designs. Device is in production to support existing customers, but TI does not recommend using this part in a new design.

PREVIEW: Device has been announced but is not in production. Samples may or may not be available.

OBSELETE: TI has discontinued the production of the device.

(2) Eco Plan - The planned eco-friendly classification: Pb-Free (RoHS), Pb-Free (RoHS Exempt), or Green (RoHS & no Sb/Br) - please check <http://www.ti.com/productcontent> for the latest availability information and additional product content details.

TBD: The Pb-Free/Green conversion plan has not been defined.

Pb-Free (RoHS): TI's terms "Lead-Free" or "Pb-Free" mean semiconductor products that are compatible with the current RoHS requirements for all 6 substances, including the requirement that lead not exceed 0.1% by weight in homogeneous materials. Where designed to be soldered at high temperatures, TI Pb-Free products are suitable for use in specified lead-free processes.

Pb-Free (RoHS Exempt): This component has a RoHS exemption for either 1) lead-based flip-chip solder bumps used between the die and package, or 2) lead-based die adhesive used between the die and leadframe. The component is otherwise considered Pb-Free (RoHS compatible) as defined above.

Green (RoHS & no Sb/Br): TI defines "Green" to mean Pb-Free (RoHS compatible), and free of Bromine (Br) and Antimony (Sb) based flame retardants (Br or Sb do not exceed 0.1% by weight in homogeneous material)

(3) MSL, Peak Temp. - The Moisture Sensitivity Level rating according to the JEDEC industry standard classifications, and peak solder temperature.

(4) There may be additional marking, which relates to the logo, the lot trace code information, or the environmental category on the device.

(5) Multiple Device Markings will be inside parentheses. Only one Device Marking contained in parentheses and separated by a "~" will appear on a device. If a line is indented then it is a continuation of the previous line and the two combined represent the entire Device Marking for that device.

(6) Lead/Ball Finish - Orderable Devices may have multiple material finish options. Finish options are separated by a vertical ruled line. Lead/Ball Finish values may wrap to two lines if the finish value exceeds the maximum column width.

Important Information and Disclaimer: The information provided on this page represents TI's knowledge and belief as of the date that it is provided. TI bases its knowledge and belief on information provided by third parties, and makes no representation or warranty as to the accuracy of such information. Efforts are underway to better integrate information from third parties. TI has taken and continues to take reasonable steps to provide representative and accurate information but may not have conducted destructive testing or chemical analysis on incoming materials and chemicals. TI and TI suppliers consider certain information to be proprietary, and thus CAS numbers and other limited information may not be available for release.

In no event shall TI's liability arising out of such information exceed the total purchase price of the TI part(s) at issue in this document sold by TI to Customer on an annual basis.

TAPE AND REEL INFORMATION

QUADRANT ASSIGNMENTS FOR PIN 1 ORIENTATION IN TAPE

*All dimensions are nominal

Device	Package Type	Package Drawing	Pins	SPQ	Reel Diameter (mm)	Reel Width W1 (mm)	A0 (mm)	B0 (mm)	K0 (mm)	P1 (mm)	W (mm)	Pin1 Quadrant
TPD1E0B04DPLR	X2SON	DPL	2	15000	178.0	8.4	0.36	0.66	0.33	2.0	8.0	Q1
TPD1E0B04DPLT	X2SON	DPL	2	250	178.0	8.4	0.36	0.66	0.33	2.0	8.0	Q1

TAPE AND REEL BOX DIMENSIONS

*All dimensions are nominal

Device	Package Type	Package Drawing	Pins	SPQ	Length (mm)	Width (mm)	Height (mm)
TPD1E0B04DPLR	X2SON	DPL	2	15000	205.0	200.0	33.0
TPD1E0B04DPLT	X2SON	DPL	2	250	205.0	200.0	33.0

DPY (R-PX1SON-N2)

PLASTIC SMALL OUTLINE NO-LEAD

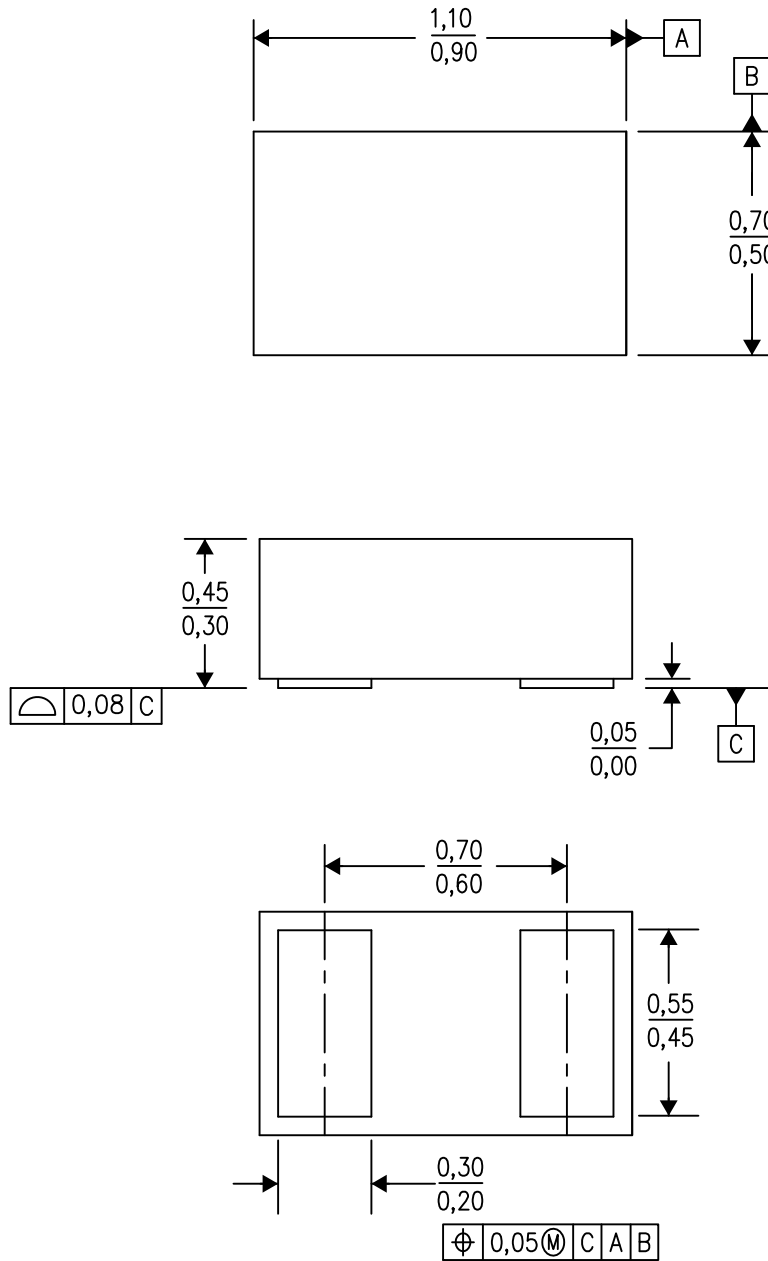

4211012/D 08/14

- NOTES:
- All linear dimensions are in millimeters. Dimensioning and tolerancing per ASME Y14.5-1994.
 - This drawing is subject to change without notice.
 - SON (Small Outline No-Lead) package configuration.

MECHANICAL DATA

DPL (R-PX2SON-N2)

PLASTIC SMALL OUTLINE NO-LEAD

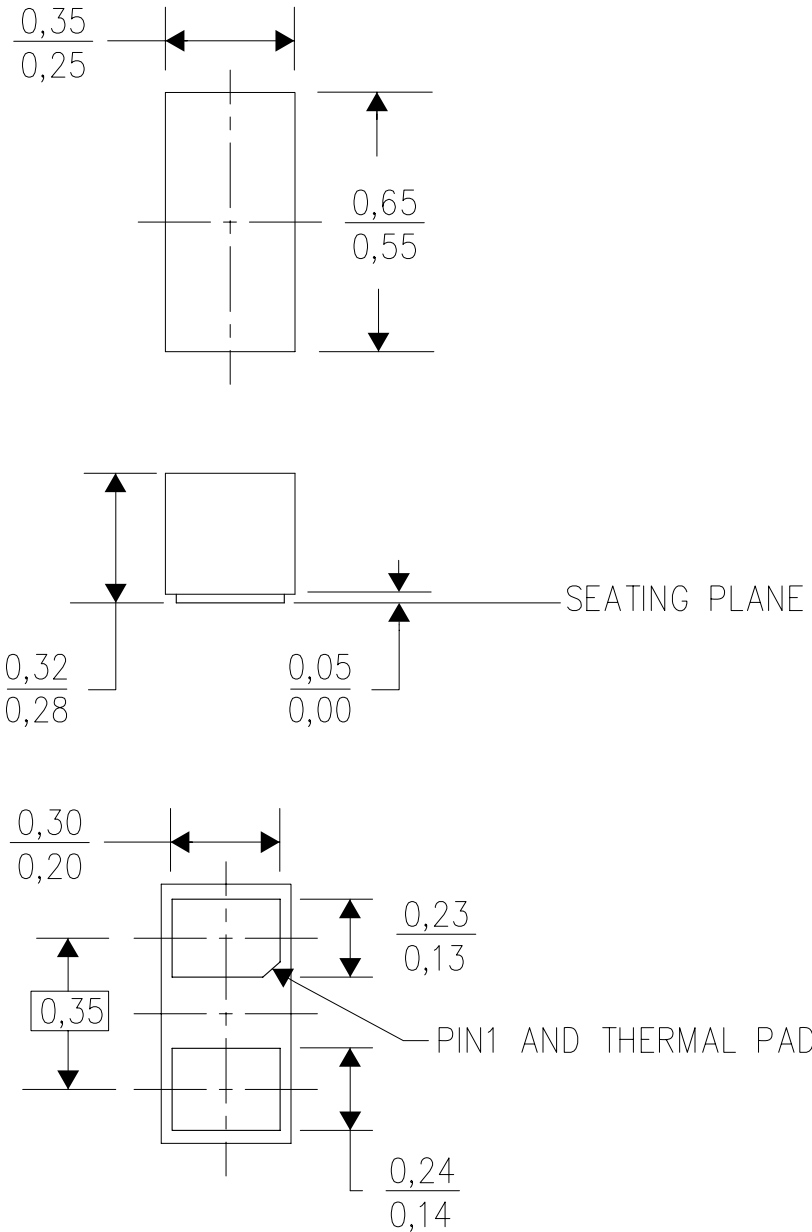

4212149/B 10/11

- NOTES:
- A. All linear dimensions are in millimeters. Dimensioning and tolerancing per ASME Y14.5M-1994.
 - B. This drawing is subject to change without notice.
 - C. Small Outline No-Lead (SON) package configuration.
 - D. The package thermal pad must be soldered to the board for thermal and mechanical performance.

Example Board Layout

Example Stencil Design
(Note E)

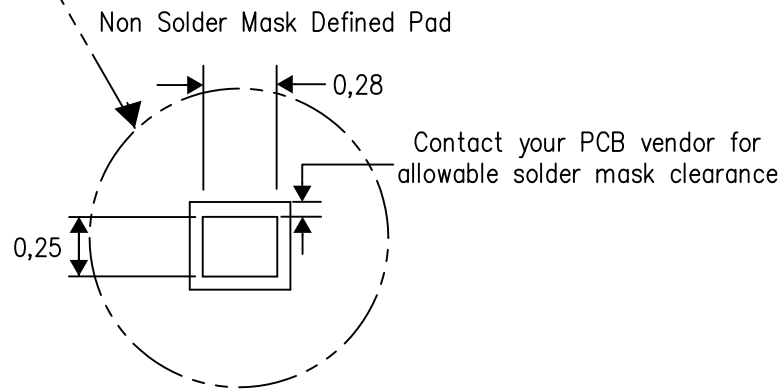
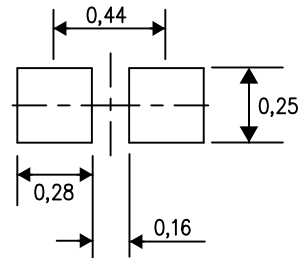
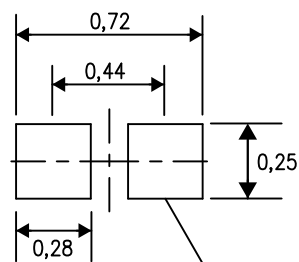

4217903/A 08/12

- NOTES:
- A. All linear dimensions are in millimeters.
 - B. This drawing is subject to change without notice.
 - C. Publication IPC-7351 is recommended for alternate designs.
 - D. Customers should contact their board fabrication site for minimum solder mask web tolerances between signal pads.
 - E. Maximum stencil thickness 0,127 mm (5 mils). All linear dimensions are in millimeters.
 - F. Laser cutting apertures with trapezoidal walls and also rounding corners will offer better paste release. Customers should contact their board assembly site for stencil design recommendations. Refer to IPC 7525 for stencil design considerations.
 - G. Side aperture dimensions over-print land for acceptable area ratio > 0.66. Customer may reduce side aperture dimensions if stencil manufacturing process allows for sufficient release at smaller opening.

IMPORTANT NOTICE

Texas Instruments Incorporated and its subsidiaries (TI) reserve the right to make corrections, enhancements, improvements and other changes to its semiconductor products and services per JESD46, latest issue, and to discontinue any product or service per JESD48, latest issue. Buyers should obtain the latest relevant information before placing orders and should verify that such information is current and complete. All semiconductor products (also referred to herein as "components") are sold subject to TI's terms and conditions of sale supplied at the time of order acknowledgment.

TI warrants performance of its components to the specifications applicable at the time of sale, in accordance with the warranty in TI's terms and conditions of sale of semiconductor products. Testing and other quality control techniques are used to the extent TI deems necessary to support this warranty. Except where mandated by applicable law, testing of all parameters of each component is not necessarily performed.

TI assumes no liability for applications assistance or the design of Buyers' products. Buyers are responsible for their products and applications using TI components. To minimize the risks associated with Buyers' products and applications, Buyers should provide adequate design and operating safeguards.

TI does not warrant or represent that any license, either express or implied, is granted under any patent right, copyright, mask work right, or other intellectual property right relating to any combination, machine, or process in which TI components or services are used. Information published by TI regarding third-party products or services does not constitute a license to use such products or services or a warranty or endorsement thereof. Use of such information may require a license from a third party under the patents or other intellectual property of the third party, or a license from TI under the patents or other intellectual property of TI.

Reproduction of significant portions of TI information in TI data books or data sheets is permissible only if reproduction is without alteration and is accompanied by all associated warranties, conditions, limitations, and notices. TI is not responsible or liable for such altered documentation. Information of third parties may be subject to additional restrictions.

Resale of TI components or services with statements different from or beyond the parameters stated by TI for that component or service voids all express and any implied warranties for the associated TI component or service and is an unfair and deceptive business practice. TI is not responsible or liable for any such statements.

Buyer acknowledges and agrees that it is solely responsible for compliance with all legal, regulatory and safety-related requirements concerning its products, and any use of TI components in its applications, notwithstanding any applications-related information or support that may be provided by TI. Buyer represents and agrees that it has all the necessary expertise to create and implement safeguards which anticipate dangerous consequences of failures, monitor failures and their consequences, lessen the likelihood of failures that might cause harm and take appropriate remedial actions. Buyer will fully indemnify TI and its representatives against any damages arising out of the use of any TI components in safety-critical applications.

In some cases, TI components may be promoted specifically to facilitate safety-related applications. With such components, TI's goal is to help enable customers to design and create their own end-product solutions that meet applicable functional safety standards and requirements. Nonetheless, such components are subject to these terms.

No TI components are authorized for use in FDA Class III (or similar life-critical medical equipment) unless authorized officers of the parties have executed a special agreement specifically governing such use.

Only those TI components which TI has specifically designated as military grade or "enhanced plastic" are designed and intended for use in military/aerospace applications or environments. Buyer acknowledges and agrees that any military or aerospace use of TI components which have **not** been so designated is solely at the Buyer's risk, and that Buyer is solely responsible for compliance with all legal and regulatory requirements in connection with such use.

TI has specifically designated certain components as meeting ISO/TS16949 requirements, mainly for automotive use. In any case of use of non-designated products, TI will not be responsible for any failure to meet ISO/TS16949.

Products

Audio	www.ti.com/audio
Amplifiers	amplifier.ti.com
Data Converters	dataconverter.ti.com
DLP® Products	www.dlp.com
DSP	dsp.ti.com
Clocks and Timers	www.ti.com/clocks
Interface	interface.ti.com
Logic	logic.ti.com
Power Mgmt	power.ti.com
Microcontrollers	microcontroller.ti.com
RFID	www.ti-rfid.com
OMAP Applications Processors	www.ti.com/omap
Wireless Connectivity	www.ti.com/wirelessconnectivity

Applications

Automotive and Transportation	www.ti.com/automotive
Communications and Telecom	www.ti.com/communications
Computers and Peripherals	www.ti.com/computers
Consumer Electronics	www.ti.com/consumer-apps
Energy and Lighting	www.ti.com/energy
Industrial	www.ti.com/industrial
Medical	www.ti.com/medical
Security	www.ti.com/security
Space, Avionics and Defense	www.ti.com/space-avionics-defense
Video and Imaging	www.ti.com/video

TI E2E Community

e2e.ti.com