

UCC28720 Constant-Voltage, Constant-Current Controller With Primary-Side Regulation

1 Features

- < 10-mW No-Load Power
- Primary-Side Regulation (PSR) Eliminates Opto-Coupler
- $\pm 5\%$ Voltage and Current Regulation Across Line and Load
- 700-V Start-Up Switch
- 80-kHz Maximum Switching Frequency Enables High-Power Density Charger Designs
- Quasi-Resonant Valley-Switching Operation for Highest Overall Efficiency
- Wide VDD Range Allows Small Bias Capacitor
- Dynamic BJT Drive
- Overvoltage, Low-Line, and Overcurrent Protection Functions
- Programmable Cable Compensation
- SOIC-7 Package

2 Applications

- USB-Compliant Adapters and Chargers for Consumer Electronics
 - Smart phones
 - Tablet computers
 - Cameras
- Standby Supply for TV and Desktop
- White Goods

3 Description

The UCC28720 flyback power supply controller provides isolated-output Constant-Voltage (CV) and Constant-Current (CC) output regulation without the use of an optical coupler. The devices process information from the primary power switch and an auxiliary flyback winding for precise control of output voltage and current.

An internal 700-V start-up switch, dynamically-controlled operating states and a tailored modulation profile support ultra-low standby power without sacrificing start-up time or output transient response.

Control algorithms in the UCC28720 allow operating efficiencies to meet or exceed applicable standards. The output drive interfaces to a bipolar transistor power switch. Discontinuous conduction mode (DCM) with valley switching reduces switching losses. Modulation of switching frequency and primary current peak amplitude (FM and AM) keeps the conversion efficiency high across the entire load and line ranges.

The controller has a maximum switching frequency of 80 kHz and always maintains control of the peak-primary current in the transformer. Protection features help keep primary and secondary component stresses in check. The UCC28720 allows compensation for voltage drop in the cable to be programmed with an external resistor.

Device Information⁽¹⁾

PART NUMBER	PACKAGE	BODY SIZE (NOM)
UCC28720	SOIC (7)	3.91 mm x 4.90 mm

(1) For all available packages, see the orderable addendum at the end of the data sheet.

Typical Application

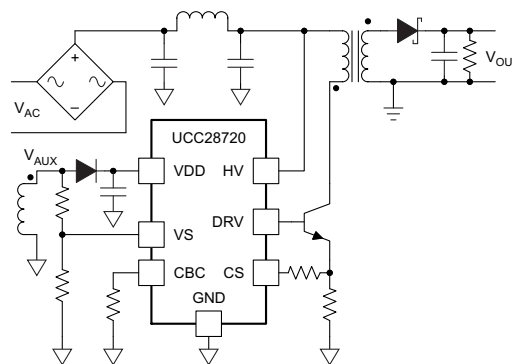

UDG-13090



Table of Contents

1 Features 1 2 Applications 1 3 Description 1 4 Revision History 2 5 Pin Configuration and Functions 3 6 Specifications 3 6.1 Absolute Maximum Ratings 3 6.2 ESD Ratings..... 4 6.3 Recommended Operating Conditions 4 6.4 Thermal Information 4 6.5 Electrical Characteristics..... 4 6.6 Switching Characteristics 5 6.7 Typical Characteristics 6 7 Detailed Description 8 7.1 Overview 8 7.2 Functional Block Diagram 8 7.3 Feature Description..... 9	7.4 Device Functional Modes..... 11 8 Application and Implementation 16 8.1 Application Information..... 16 8.2 Typical Application 16 9 Power Supply Recommendations 21 10 Layout 22 10.1 Layout Guidelines 22 10.2 Layout Example 22 11 Device and Documentation Support 24 11.1 Device Support 24 11.2 Documentation Support 25 11.3 Community Resources..... 26 11.4 Trademarks 26 11.5 Electrostatic Discharge Caution..... 26 11.6 Glossary 26 12 Mechanical, Packaging, and Orderable Information 27
---	---

4 Revision History

NOTE: Page numbers for previous revisions may differ from page numbers in the current version.

Changes from Revision A (January 2014) to Revision B	Page
<ul style="list-style-type: none"> • Added <i>ESD Ratings</i> table, <i>Feature Description</i> section, <i>Device Functional Modes</i>, <i>Application and Implementation</i> section, <i>Power Supply Recommendations</i> section, <i>Layout</i> section, <i>Device and Documentation Support</i> section, and <i>Mechanical, Packaging, and Orderable Information</i> section. 	1

Changes from Original (May 2014) to Revision A	Page
<ul style="list-style-type: none"> • Changed C_{DD} equation. 	20

5 Pin Configuration and Functions

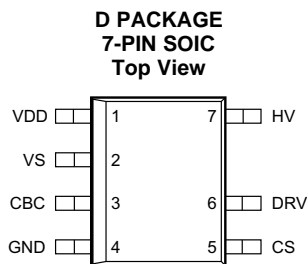

Pin Functions

PIN		I/O	DESCRIPTION
NAME	NO.		
VDD	1	I	VDD is the bias supply input pin to the controller. A carefully-placed bypass capacitor to GND is required on this pin.
VS	2	I	Voltage sense is an input used to provide voltage and timing feedback to the controller. This pin is connected to a voltage divider between an auxiliary winding and GND. The value of the upper resistor of this divider is used to program the AC-mains run and stop thresholds and line compensation at the CS pin.
CBC	3	I	Cable compensation is a programming pin for compensation of cable voltage drop. Cable compensation is programmed with a resistor to GND.
GND	4	—	The ground pin is both the reference pin for the controller and the low-side return for the drive output. Special care must be taken to return all AC decoupling capacitors as close as possible to this pin and avoid any common trace length with analog signal return paths.
CS	5	I	Current sense input connects to a ground-referenced current-sense resistor in series with the power switch. The resulting voltage is used to monitor and control the peak primary current. A series resistor can be added to this pin to compensate the peak switch current levels as the AC-mains input varies.
DRV	6	O	Drive is an output used to drive the base of an external high voltage NPN transistor.
HV	7	I	The high-voltage pin connects directly to the rectified bulk voltage and provides charge to the VDD capacitor for start-up of the power supply.

6 Specifications

6.1 Absolute Maximum Ratings⁽¹⁾

		MIN	MAX	UNIT
V _{HV}	Start-up pin voltage, HV		700	V
V _{VDD}	Bias supply voltage, VDD		38	V
I _{DRV}	Continuous base current sink		50	mA
I _{DRV}	Continuous base current source		Self-limiting	mA
I _{VS}	Peak current, VS		-1.2	mA
V _{DRV}	Base drive voltage at DRV	-0.5	Self-limiting	V
VS	Voltage	-0.75	7	V
CS, CBC		-0.5	5	V
T _J	Operating junction temperature	-55	150	°C
	Lead temperature 0.6 mm from case for 10 seconds		260	°C
T _{STG}	Storage temperature	-65	150	°C

- (1) Stresses beyond those listed under “*Absolute Maximum Ratings*” may cause permanent damage to the device. Exposure to absolute-maximum-rated conditions for extended periods may affect device reliability. These are stress ratings only and functional operation of the device at these or any other conditions beyond those indicated under “*Recommended Operating Conditions*” is not implied. Extended exposure to stresses above the Recommended Operating Conditions may affect device reliability. All voltages are with respect to GND. Currents are positive into, negative out of the specified terminal. These ratings apply over the operating ambient temperature ranges unless otherwise noted.

6.2 ESD Ratings

		VALUE	UNIT	
V _(ESD)	Electrostatic discharge	Human-body model (HBM), per ANSI/ESDA/JEDEC JS-001 ⁽¹⁾	±2000	V
		Charged-device model (CDM), per JEDEC specification JESD22-C101 ⁽²⁾	±500	V

(1) JEDEC document JEP155 states that 500-V HBM allows safe manufacturing with a standard ESD control process.

(2) JEDEC document JEP157 states that 250-V CDM allows safe manufacturing with a standard ESD control process.

6.3 Recommended Operating Conditions

over operating free-air temperature range (unless otherwise noted)

		MIN	NOM	MAX	UNIT
VDD	Bias supply operating voltage	9		35	V
C _{VDD}	VDD bypass capacitor	1.0		10	μF
R _{CBC}	Cable-compensation resistance	10			kΩ
I _{VS}	VS pin current	-1			mA
T _J	Operating junction temperature	-40		125	°C

6.4 Thermal Information

THERMAL METRIC ⁽¹⁾		UCC28720	UNIT
		D (SOIC)	
		7 PIN	
R _{θJA}	Junction-to-ambient thermal resistance	141.5	°C/W
R _{θJC(top)}	Junction-to-case (top) thermal resistance	73.8	°C/W
R _{θJB}	Junction-to-board thermal resistance	89.0	°C/W
ψ _{JT}	Junction-to-top characterization parameter	23.5	°C/W
ψ _{JB}	Junction-to-board characterization parameter	88.2	°C/W

(1) For more information about traditional and new thermal metrics, see the *IC Package Thermal Metrics* application report, [SPRA953](#).

6.5 Electrical Characteristics

over operating free-air temperature range, V_{VDD} = 25 V, HV = open, R_{CBC} = open, T_A = -40°C to 125°C, T_A = T_J (unless otherwise noted)

PARAMETER	TEST CONDITIONS	MIN	TYP	MAX	UNIT	
HIGH-VOLTAGE START UP						
I _{HV}	Start-up current out of VDD	V _{HV} = 100 V, V _{VDD} = 0 V, start state	100	225	500	μA
I _{HV LKG}	Leakage current at HV	V _{HV} = 400 V, run state, T _J = 25 °C		0.01	0.25	μA
BIAS SUPPLY INPUT						
I _{RUN}	Supply current, run	I _{DRV} = 0, run state		2.00	2.65	mA
I _{WAIT}	Supply current, wait	I _{DRV} = 0, wait state		95	150	μA
I _{START}	Supply current, start	I _{DRV} = 0, V _{VDD} = 18 V, start state, I _{HV} = 0		18	30	μA
I _{FAULT}	Supply current, fault	I _{DRV} = 0, fault state		95	150	μA
UNDERVOLTAGE LOCKOUT						
V _{VDD(on)}	VDD turn-on threshold	V _{VDD} low to high	19	21	23	V
V _{VDD(off)}	VDD turn-off threshold	V _{VDD} high to low	7.35	7.7	8.15	V
VS INPUT						
V _{VSR}	Regulating level	Measured at no-load condition, T _J = 25°C ⁽¹⁾	4.01	4.05	4.09	V
						V
V _{VSN C}	Negative clamp level	I _{VS} = -300 μA, volts below ground	190	250	325	mV
I _{VS B}	Input bias current	V _{VS} = 4 V	-0.25	0	0.25	μA

(1) The regulating level and over voltage at VS decreases with temperature by 0.8 mV/°C. This compensation is included to reduce the power supply output voltage variance over temperature.

Electrical Characteristics (continued)

over operating free-air temperature range, $V_{DD} = 25\text{ V}$, HV = open, $R_{CBC} = \text{open}$, $T_A = -40^\circ\text{C}$ to 125°C , $T_A = T_J$ (unless otherwise noted)

PARAMETER	TEST CONDITIONS	MIN	TYP	MAX	UNIT	
CS INPUT						
$V_{CST(max)}$	Max CS threshold voltage	$V_{VS} = 3.7\text{ V}$	735	780	815	mV
$V_{CST(min)}$	Min CS threshold voltage	$V_{VS} = 4.35\text{ V}$	175	190	215	mV
K_{AM}	AM control ratio	$V_{CST(max)} / V_{CST(min)}$	3.6	4.0	4.4	V/V
V_{CCR}	Constant current regulating level	CC regulation constant	317	330	344	mV
K_{LC}	Line compensation current ratio	$I_{VSL} = -300\ \mu\text{A}$, I_{VSL} / current out of CS pin	24.0	25.0	28.6	A/A
T_{CSLEB}	Leading-edge blanking time	DRV output duration, $V_{CS} = 1\text{ V}$	230	290	355	ns
DRIVER						
$I_{DRS(max)}$	Maximum DRV source current	$V_{DRV} = 2\text{ V}$, $V_{DD} = 9\text{ V}$, $V_{VS} = 3.85\text{ V}$	32	37	41	mA
$I_{DRS(min)}$	Minimum DRV source current	$V_{DRV} = 2\text{ V}$, $V_{DD} = 9\text{ V}$, $V_{VS} = 4.30\text{ V}$	16	19	22	mA
R_{DRVLS}	DRV low-side drive resistance	$I_{DRV} = 10\text{ mA}$		1	2.4	Ω
V_{DRCL}	DRV clamp voltage	$V_{DD} = 35\text{ V}$		5.9	7	V
R_{DRVSS}	DRV pull-down in start state			20	25	k Ω
V_{OVP}	Over-voltage threshold	At VS input, $T_J = 25^\circ\text{C}^{(1)}$	4.51	4.60	4.73	V
V_{OCP}	Over-current threshold	At CS input	1.4	1.5	1.6	V
$I_{VSL(run)}$	VS line-sense run current	Current out of VS pin increasing	190	225	275	μA
$I_{VSL(stop)}$	VS line-sense stop current	Current out of VS pin decreasing	70	80	100	μA
K_{VSL}	VS line sense ratio	$I_{VSL(run)} / I_{VSL(stop)}$	2.45	2.80	3.05	A/A
$T_{J(stop)}$	Thermal shut-down temperature	Internal junction temperature		165		$^\circ\text{C}$
CABLE COMPENSATION						
$V_{CBC(max)}$	Cable compensation maximum voltage	Voltage at CBC at full load	2.9	3.1	3.5	V
$V_{CVS(min)}$	Minimum compensation at VS	$V_{CBC} = \text{open}$, change in VS regulating level at full load	-55	-15	25	mV
$V_{CVS(max)}$	Maximum compensation at VS	$V_{CBC} = 0\text{ V}$, change in VS regulating level at full load	275	320	380	mV

6.6 Switching Characteristics

over operating free-air temperature range (unless otherwise noted)

PARAMETER	TEST CONDITIONS	MIN	TYP	MAX	UNIT	
$f_{SW(max)}$ +	Maximum switching frequency	$V_{VS} = 3.7\text{ V}$	74	80	87	kHz
$f_{SW(min)}$	Minimum switching frequency	$V_{VS} = 4.35\text{ V}$	580	650	740	Hz
t_{ZTO}	Zero-crossing timeout delay		2.5	3.1	3.6	μs

6.7 Typical Characteristics

VDD = 25 V, unless otherwise noted.

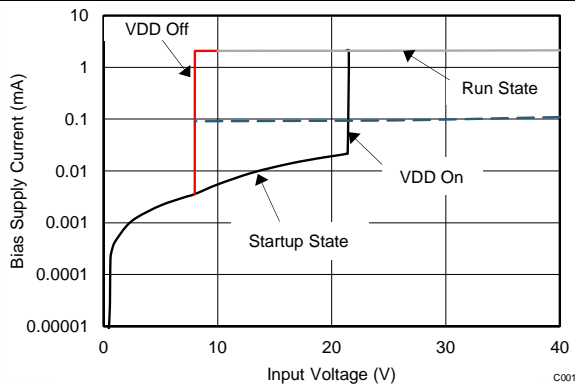

Figure 1. Bias Supply Current vs. VDD Voltage

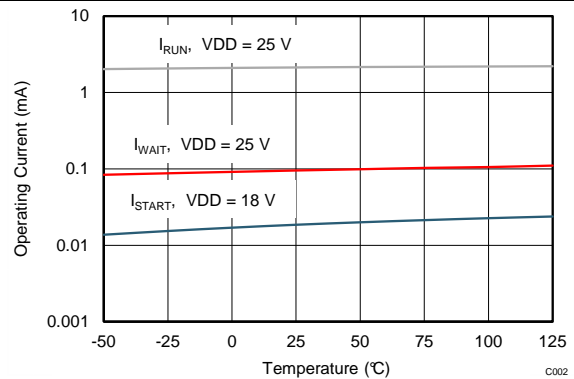

Figure 2. Operating Current vs. Junction Temperature

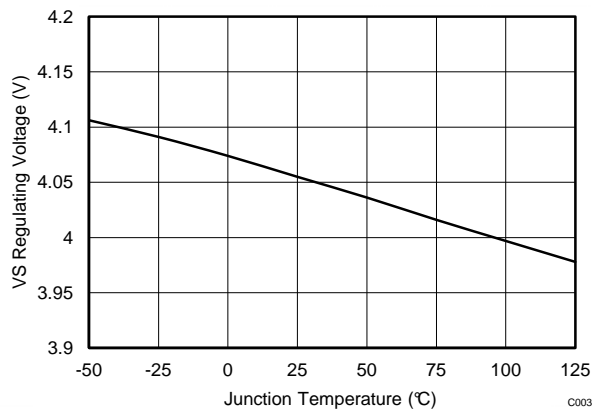

Figure 3. VS Pin Regulation Voltage vs. Junction Temperature

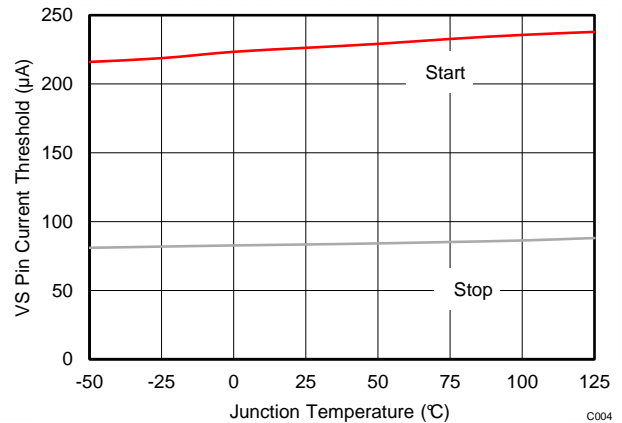

Figure 4. VS Pin Start and Stop Thresholds vs. Junction Temperature

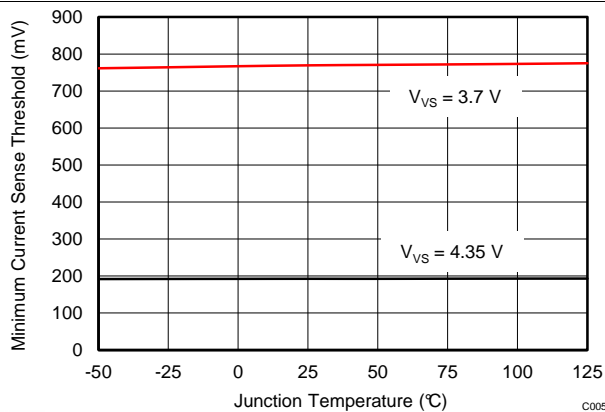

Figure 5. Current Sense Threshold vs. Temperature

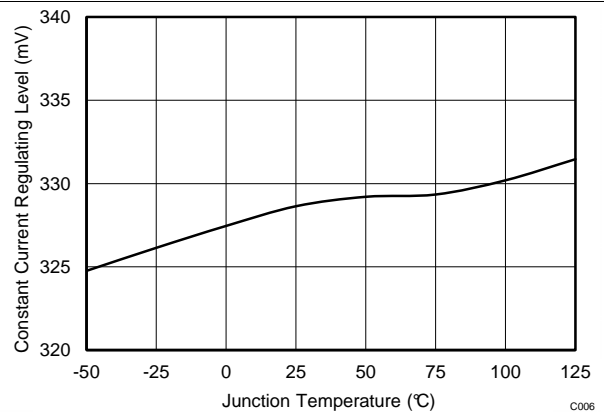

Figure 6. Constant Current Regulation Level vs. Junction Temperature

Typical Characteristics (continued)

VDD = 25 V, unless otherwise noted.

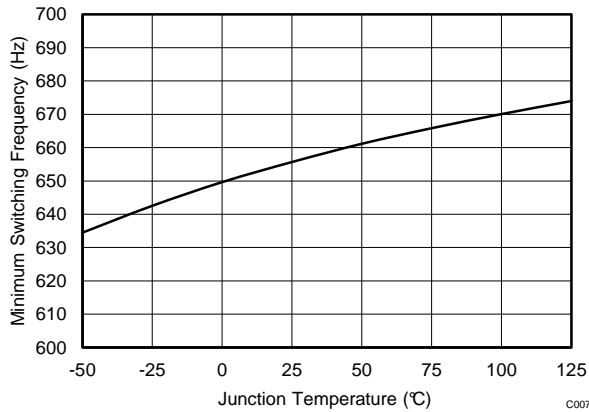

Figure 7. Minimum Switching Frequency vs. Junction Temperature

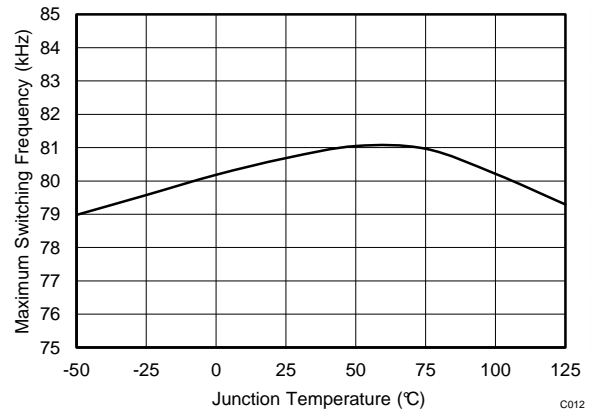

Figure 8. Maximum Switching Frequency vs. Junction Temperature

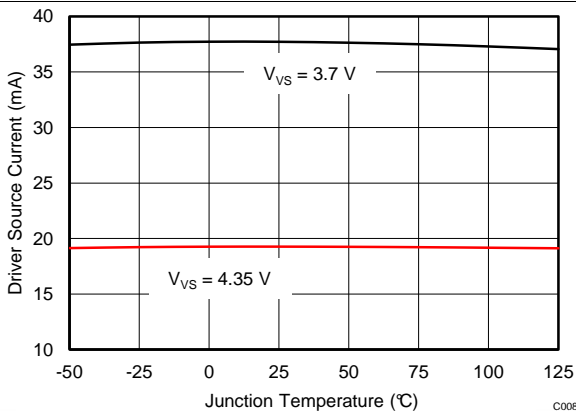

Figure 9. Driver Output Source Current vs. Junction Temperature

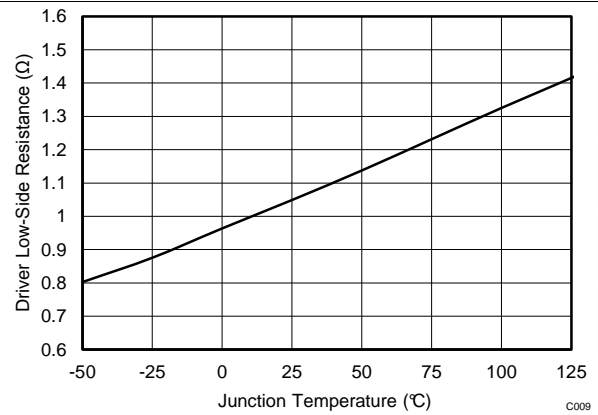

Figure 10. Driver Pull Down Resistance vs. Junction Temperature

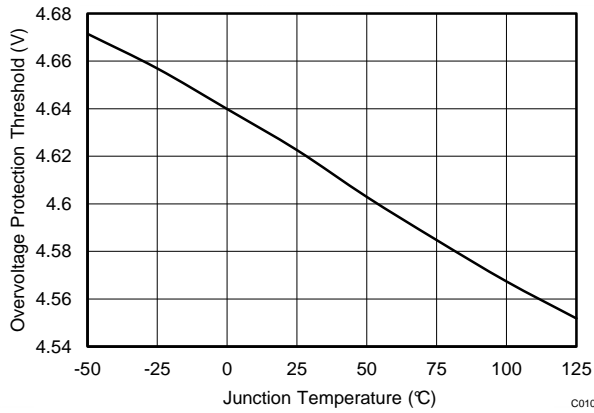

Figure 11. Over Voltage Protection Threshold vs. Junction Temperature

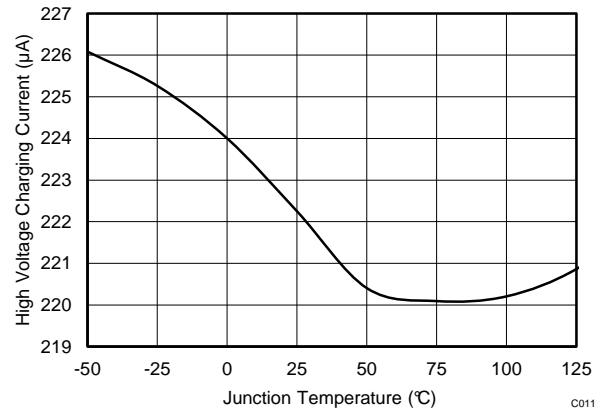

Figure 12. HV Charging Current vs. Junction Temperature

7 Detailed Description

7.1 Overview

The UCC28720 is a flyback power supply controller which provides accurate voltage and constant current regulation with primary-side feedback, eliminating the need for opto-coupler feedback circuits. The controller operates in discontinuous conduction mode with valley-switching to minimize switching losses. The modulation scheme is a combination of frequency and primary peak current modulation to provide high conversion efficiency across the load range. The control law provides a wide-dynamic operating range of output power which allows the power designer to achieve the <10-mW stand-by power requirement.

During low-power operating ranges the device has power management features to reduce the device operating current at operating frequencies below 28 kHz. Accurate voltage and constant current regulation, fast dynamic response, and fault protection are achieved with primary-side control. A complete charger solution can be realized with a straightforward design process, low cost and low component count.

7.2 Functional Block Diagram

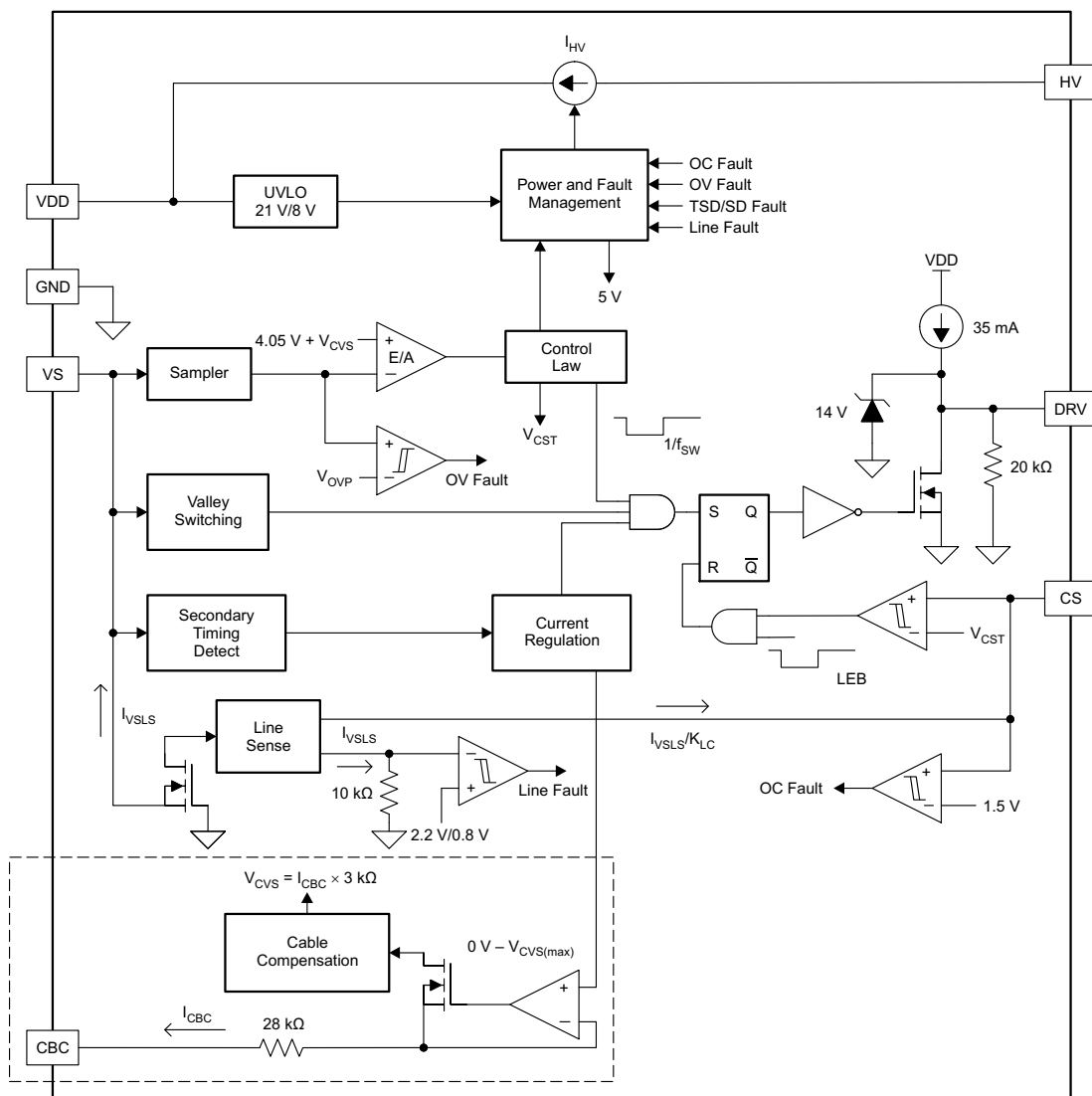

UDG-13094

7.3 Feature Description

7.3.1 Detailed Pin Description

VDD (Device Bias Voltage Supply): The VDD pin is connected to a bypass capacitor to ground. The VDD turn-on UVLO threshold is 21 V and turn-off UVLO threshold is 8.1 V, with an available operating range up to 35 V on VDD. The USB charging specification requires the output current to operate in constant-current mode from 5 V to a minimum of 2 V; this is easily achieved with a nominal VDD of approximately 25 V. The additional VDD headroom up to 35 V allows for VDD to rise due to the leakage energy delivered to the VDD capacitor in high-load conditions.

GND (Ground): There is a single ground reference external to the device for the base drive current and analog signal reference. Place the VDD bypass capacitor close to GND and VDD with short traces to minimize noise on the VS and CS signal pins.

HV (High Voltage Start-up): The HV pin is connected directly to the bulk capacitor to provide start-up current to the VDD capacitor. The typical start-up current is ~300 μ A which provides fast charging of the VDD capacitor. The internal HV start-up device is active until VDD exceeds the turn-on UVLO threshold at which time the HV start-up device is turned off. In the off state the leakage current is very low to minimize standby losses of the controller. When VDD falls below the UVLO turn-off threshold the HV start-up device is turned on.

VS (Voltage-Sense): The VS pin is connected to a resistor divider from the auxiliary winding to ground. The output-voltage feedback information is sampled at the end of the transformer secondary current demagnetization time to provide an accurate representation of the output voltage. Timing information to achieve valley-switching and to control the duty cycle of the secondary transformer current is determined by the waveform on the VS pin. Avoid placing a filter capacitor on this input which would interfere with accurate sensing of this waveform.

The VS pin also senses the bulk capacitor voltage to provide for AC-input run and stop thresholds, and to compensate the current-sense threshold across the AC-input range. During the transistor on-time the VS pin is clamped to approximately 250 mV below GND and the current out of the VS pin is sensed. For the AC-input run/stop function, the run threshold on VS is 225 μ A and the stop threshold is 80 μ A. The values for the auxiliary voltage divider upper-resistor R_{S1} and lower-resistor R_{S2} can be determined by the equations below.

$$R_{S1} = \frac{V_{IN(run)} \times \sqrt{2}}{N_{PA} \times I_{VSL(run)}}$$

where

- N_{PA} is the transformer primary-to-auxiliary turns ratio,
 - $V_{IN(run)}$ is the AC RMS voltage to enable turn-on of the controller (run),
 - $I_{VSL(run)}$ is the run-threshold for the current pulled out of the VS pin during the switch on-time. (see [Electrical Characteristics](#))
- (1)

$$R_{S2} = \frac{R_{S1} \times V_{VSR}}{N_{AS} \times (V_{OCV} + V_F) - V_{VSR}}$$

where

- V_{OCV} is the converter regulated output voltage,
 - V_F is the output rectifier forward drop at near-zero current,
 - N_{AS} is the transformer auxiliary to secondary turns ratio,
 - R_{S1} is the VS divider high-side resistance,
 - V_{VSR} is the CV regulating level at the VS input (see [Electrical Characteristics](#)).
- (2)

DRV (Base Drive): The DRV pin is connected to the NPN transistor base pin. The driver provides a base drive signal limited to 7 V. The turn-on characteristic of the driver is a 15 mA to 35-mA current source that is scaled with the current sense threshold dictated by the operating point in the control scheme. When the minimum current sense threshold is being used, the base drive current is also at its minimum value. As the current sense threshold is increased to the maximum, the base drive current scales linearly with it to its maximum of 35 mA typical. The turn-off current is determined by the low-side driver $R_{DS(on)}$

Feature Description (continued)

CS (Current Sense): The current-sense pin is connected through a series resistor (R_{LC}) to the current-sense resistor (R_{CS}). The current-sense threshold is 0.78 V for $I_{PP(max)}$ and 0.195 V for $I_{PP(min)}$. The series resistor R_{LC} provides the function of feed-forward line compensation to eliminate change in I_{PP} due to change in di/dt and the propagation delay of the internal comparator and NPN transistor turn-off time. There is an internal leading-edge blanking time of approximately 300 ns to eliminate sensitivity to the turn-on current spike. It should not be necessary to place a bypass capacitor on the CS pin. The value of R_{CS} is determined by the target output current in Constant Current (CC) regulation. The values of R_{CS} and R_{LC} can be determined by the equations below. The term η_{XFMR} is intended to account for the energy stored in the transformer but not delivered to the secondary. This includes transformer resistance and core loss, bias power, and primary-to-secondary leakage ratio.

Example: With a transformer core and winding loss of 5%, primary-to-secondary leakage inductance of 3.5%, and bias power to output power ratio of 1.5%. The η_{XFMR} value is approximately: $1 - 0.05 - 0.035 - 0.015 = 0.9$.

$$R_{CS} = \frac{V_{CCR} \times N_{PS}}{2I_{OCC}} \times \sqrt{\eta_{XFMR}}$$

where

- V_{CCR} is a current regulation constant (see [Electrical Characteristics](#)),
- N_{PS} is the transformer primary-to-secondary turns ratio (a ratio of 13 to 15 is recommended for 5-V output),
- I_{OCC} is the target output current in constant-current regulation,
- η_{XFMR} is the transformer efficiency. (3)

$$R_{LC} = \frac{K_{LC} \times R_{S1} \times R_{CS} \times t_D \times N_{PA}}{L_P}$$

where

- R_{S1} is the VS pin high-side resistor value,
- R_{CS} is the current-sense resistor value,
- t_D is the current-sense delay including NPN transistor turn-off delay, add ~50 ns to transistor delay,
- N_{PA} is the transformer primary-to-auxiliary turns ratio,
- L_P is the transformer primary inductance,
- K_{LC} is a current-scaling constant (see [Electrical Characteristics](#)). (4)

CBC (Cable Compensation): The cable compensation pin is connected to a resistor to ground to program the amount of output voltage compensation to offset cable resistance. The cable compensation block provides a 0-V to 3-V voltage level on the CBC pin corresponding to $I_{OCC(max)}$ output current. Connecting a resistance from CBC to GND programs a current that is summed into the VS feedback divider, increasing the regulation voltage as I_{OUT} increases. There is an internal series resistance of 28 k Ω to the CBC pin which sets a maximum cable compensation of a 5-V output to 400 mV when CBC is shorted to ground. The CBC resistance value can be determined by the equation below.

$$R_{CBC} = \frac{V_{CBC(max)} \times 3 \text{ k}\Omega \times (V_{OCV} + V_F)}{V_{VSR} \times V_{OCBC}} - 28 \text{ k}\Omega$$

where

- V_{OCV} is the regulated output voltage,
- V_F is the diode forward voltage in V,
- V_{OCBC} is the target cable compensation voltage at the output terminals,
- $V_{CBC(max)}$ is the maximum voltage at the cable compensation pin at the maximum converter output current (see [Electrical Characteristics](#)),
- V_{VSR} is the CV regulating level at the VS input (see [Electrical Characteristics](#)). (5)

7.4 Device Functional Modes

7.4.1 Primary-Side Voltage Regulation

Figure 13 illustrates a simplified flyback converter with the main voltage regulation blocks of the device shown. The power train operation is the same as any DCM flyback circuit but accurate output voltage and current sensing is the key to primary-side control.

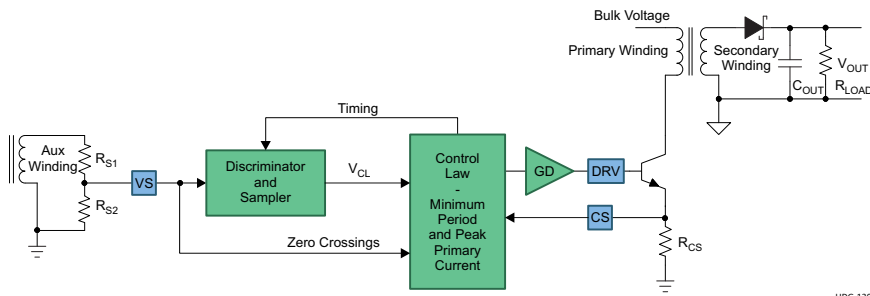

Figure 13. Simplified Flyback Converter (with the Main Voltage Regulation Blocks)

In primary-side control, the output voltage is sensed on the auxiliary winding during the transfer of transformer energy to the secondary. As shown in Figure 14 it is clear there is a down slope representing a decreasing total rectifier V_F and resistance voltage drop ($I_S R_S$) as the secondary current decreases to zero. To achieve an accurate representation of the secondary output voltage on the auxiliary winding, the discriminator reliably recognizes the leakage inductance reset and ringing and ignores it, continuously samples the auxiliary voltage during the down slope after the ringing is diminished, and captures the error signal at the time the secondary winding reaches zero current. The internal reference on VS is 4.05 V. Temperature compensation on the VS reference voltage of $-0.8\text{-mV}/^\circ\text{C}$ offsets the change in the output rectifier forward voltage with temperature. The resistor divider is selected as outlined in the VS pin description.

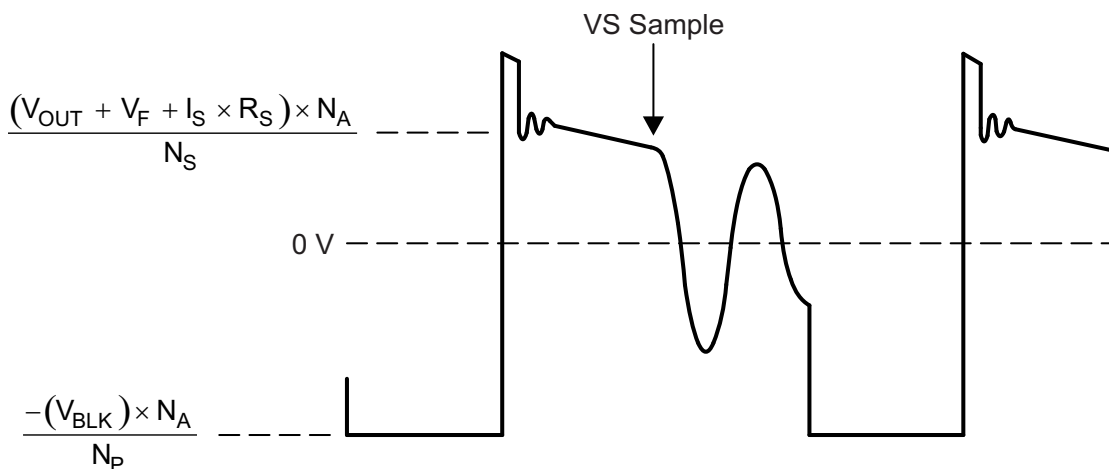

Figure 14. Auxiliary Winding Voltage

The UCC28720 includes a VS signal sampler that uses discrimination methods to ensure an accurate sample of the output voltage from the auxiliary winding. There are some conditions that must be met on the auxiliary winding signal to ensure reliable operation. These conditions are the reset time of the leakage inductance and the duration of any subsequent leakage inductance ring. Refer to Figure 15 below for a detailed illustration of waveform criteria to ensure a reliable sample on the VS pin. The first detail to examine is the duration of the leakage inductance reset pedestal, t_{LK_RESET} in Figure 15. Because this can mimic the waveform of the secondary current decay, followed by a sharp downslope, it is important to keep the leakage reset time less than 600 ns for I_{PRI} minimum, and less than 2.2 μs for I_{PRI} maximum. The second detail is the amplitude of ringing on

Device Functional Modes (continued)

the V_{AUX} waveform following t_{LK_RESET} . The peak-to-peak voltage at the VS pin should be less than approximately 100 mV_{p-p} at least 200 ns before the end of the demagnetization time, t_{DM} . If there is a concern with excessive ringing, it usually occurs during light or no-load conditions, when t_{DM} is at the minimum. The tolerable ripple on VS scales up when measured at the auxiliary winding by R_{S1} and R_{S2} , and is equal to $100\text{ mV} \times (R_{S1} + R_{S2}) / R_{S2}$ when measured directly at the auxilliary winding.

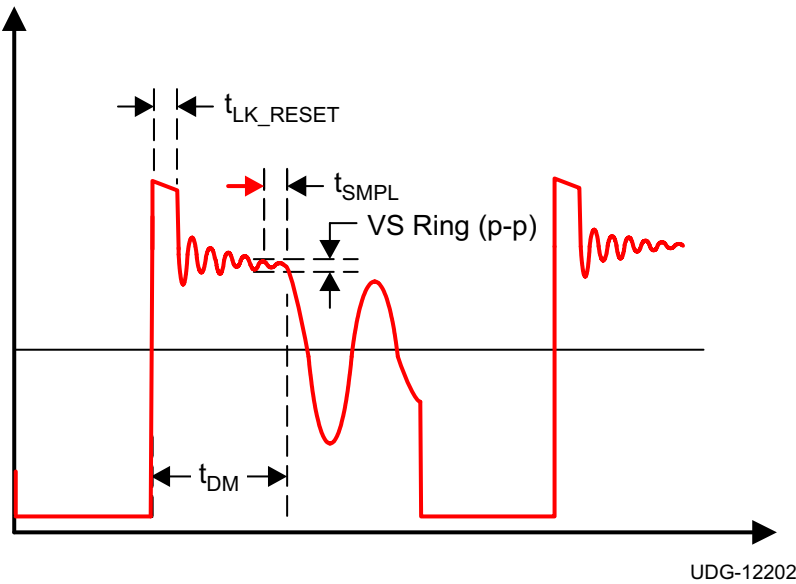

Figure 15. Auxiliary Waveform Details

During voltage regulation, the controller operates in frequency modulation mode and amplitude modulation mode as illustrated in Figure 16 below. The internal operating frequency limits of the device are 80 kHz , $f_{SW(max)}$ and 65 Hz , $f_{SW(min)}$. The transformer primary inductance and primary peak current chosen sets the maximum operating frequency of the converter. The output preload resistor and efficiency at low power determines the converter minimum operating frequency. There is no stability compensation required for the UCC28720.

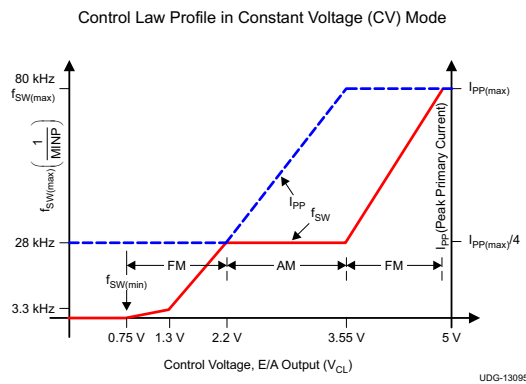
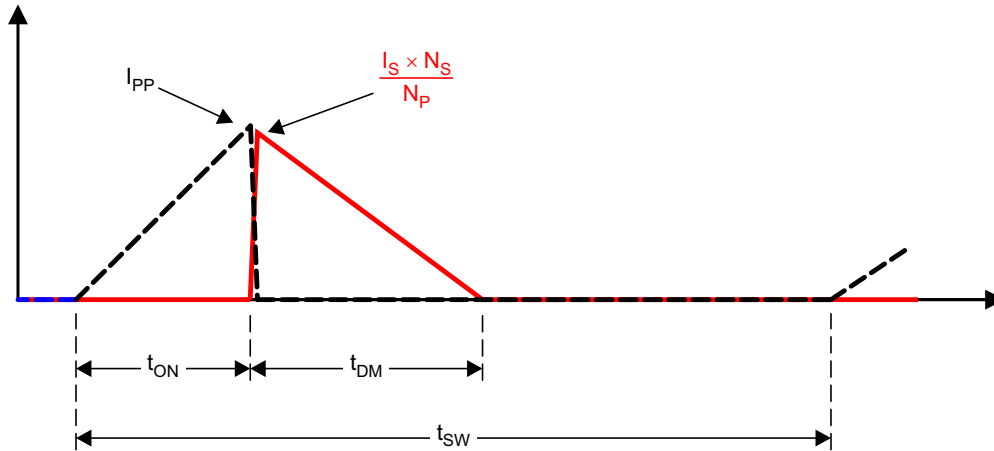

Figure 16. Frequency and Amplitude Modulation Modes (during Voltage Regulation)

Device Functional Modes (continued)

7.4.2 Primary-Side Current Regulation

Timing information at the VS pin and current information at the CS pin allow accurate regulation of the secondary average current. The control law dictates that as power is increased in CV regulation and approaching CC regulation the primary-peak current is at $I_{PP(max)}$. Referring to Figure 17 below, the primary-peak current, turns ratio, secondary demagnetization time (t_{DM}), and switching period (t_{SW}) determine the secondary average output current. Ignoring leakage inductance effects, the average output current is given by Equation 6. When the average output current reaches the regulation reference in the current control block, the controller operates in frequency modulation mode to control the output current at any output voltage at or below the voltage regulation target as long as the auxiliary winding can keep VDD above the UVLO turn-off threshold.



UDG-12203

Figure 17. Transformer Currents

$$I_{OUT} = \frac{I_{PP}}{2} \times \frac{N_P}{N_S} \times \frac{t_{DM}}{t_{SW}} \quad (6)$$

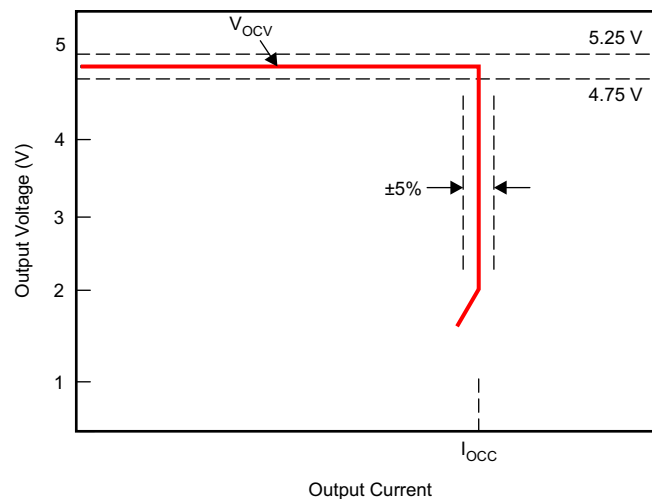

UDG-12201

Figure 18. Typical Target Output V-I Characteristic

7.4.3 Valley Switching

The UCC28720 utilizes valley switching to reduce switching losses in the transistor, to reduce induced-EMI, and to minimize the turn-on current spike at the sense resistor. The controller operates in valley-switching in all load conditions unless the collector voltage (V_C) ringing has subsided.

Device Functional Modes (continued)

Referring to [Figure 19](#) below, the UCC28720 operates in a valley-skipping mode in most load conditions to maintain an accurate voltage or current regulation point and still switch on the lowest available V_C .

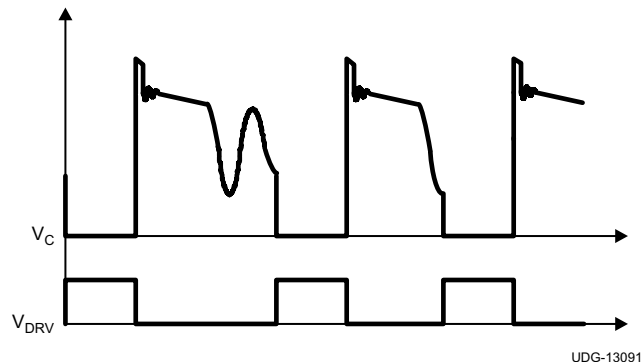

Figure 19. Valley-Skipping Mode

7.4.4 Start-Up Operation

The internal high-voltage start-up switch connected to the bulk capacitor voltage (V_{BLK}) through the HV pin charges the VDD capacitor. During start up there is typically 300 μA available to charge the VDD capacitor. When VDD reaches the 21-V UVLO turn-on threshold, the controller is enabled, the converter starts switching and the start-up switch is turned off. The initial three cycles are limited to $I_{PP(\text{min})}$. After the initial three cycles at minimum $I_{PP(\text{min})}$, the controller responds to the condition dictated by the control law. The converter will remain in discontinuous mode during charging of the output capacitor(s), maintaining a constant output current until the output voltage is in regulation.

7.4.5 Fault Protection

The UCC28720 provides comprehensive fault protection. Protection functions include:

- Output over-voltage fault
- Input under-voltage fault
- Internal over-temperature fault
- Primary over-current fault
- CS pin fault
- VS pin fault

A UVLO reset and restart sequence applies for all fault protection events.

The output over-voltage function is determined by the voltage feedback on the VS pin. If the voltage sample on VS exceeds 115% of the nominal V_{OUT} , the device stops switching and the internal current consumption is I_{FAULT} which discharges the VDD capacitor to the UVLO turn-off threshold. After that, the device returns to the start state and a start-up sequence ensues.

The UCC28720 always operates with cycle-by-cycle primary peak current control. The normal operating range of the CS pin is 0.78 V to 0.195 V. There is additional protection if the CS pin reaches 1.5 V. This results in a UVLO reset and restart sequence.

The line input run and stop thresholds are determined by current information at the VS pin during the transistor on-time. While the VS pin is clamped close to GND during the transistor on-time, the current through R_{S1} is monitored to determine a sample of the bulk capacitor voltage. A wide separation of run and stop thresholds allows clean start-up and shut-down of the power supply with the line voltage. The run current threshold is 225 μA and the stop current threshold is 80 μA .

The internal over-temperature protection threshold is 165°C. If the junction temperature reaches this threshold the device initiates a UVLO reset cycle. If the temperature is still high at the end of the UVLO cycle, the protection cycle repeats.

Device Functional Modes (continued)

Protection is included in the event of component failures on the VS pin. If complete loss of feedback information on the VS pin occurs, the controller stops switching and restarts.

8 Application and Implementation

NOTE

Information in the following applications sections is not part of the TI component specification, and TI does not warrant its accuracy or completeness. TI's customers are responsible for determining suitability of components for their purposes. Customers should validate and test their design implementation to confirm system functionality.

8.1 Application Information

The UCC28720 flyback power supply controller provides constant voltage (CV) and constant current (CC) output regulation to help meet USB-compliant adaptors and charger requirements. This device uses the information obtained from auxiliary winding sensing (VS) to control the output voltage and does not require optocoupler/TL431 feedback circuitry. Not requiring optocoupler feedback reduces the component count and makes the design more cost effective and efficient.

8.2 Typical Application

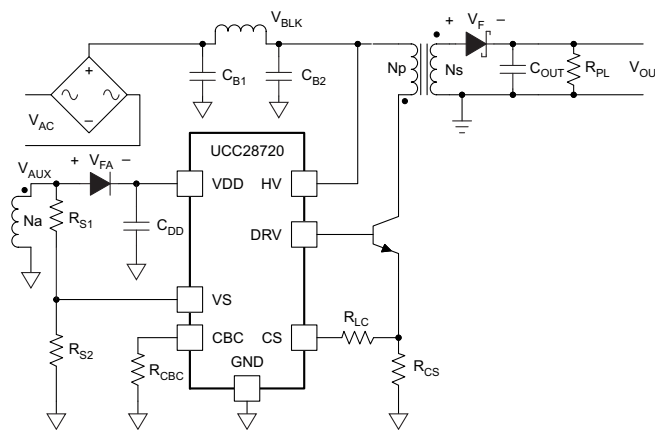

UDG-13092

Figure 20. Design Procedure Application Example

Typical Application (continued)

8.2.1 Design Requirements

The design parameters are listed in [Table 1](#).

Table 1. Design Parameters

PARAMETER	TEST CONDITIONS	MIN	NOM	MAX	UNIT		
INPUT CHARACTERISTICS							
V _{IN}	RMS Input Voltage	100 (V _{IN(MIN)})	115/230	240	V		
f _{LINE}	Line Frequency	47	50/60	64	Hz		
P _{SB_CONV}	No Load Input Power	V _{IN} = Nom, I _{OUT} = 0 A		10	mW		
V _{IN(RUN)}	Brownout Voltage	I _{OUT} = Nom		70	V		
OUTPUT CHARACTERISTICS							
V _{OCV}	Output Voltage	V _{IN} = Nom, I _{OUT} = NOM		4.75	5	5.25	V
V _{RIPPLE}	Output Voltage Ripple	V _{IN} = Nom, I _O = Max		0.1		V	
I _{OUT}	Output Current	V _{IN} = Min to Max		1	1.05	A	
	Output OVP	I _{OUT} = Min to Max		5.75		V	
	Transient Response						
	Load Step (I _{TRAN} = 0.6 A)	(0.1 to 0.6 A) or (0.6 to 0.1 A) V _{OD} = 0.9 V for Calculations		4.1	5	5	V
SYSTEMS CHARACTERISTICS							
f _{MAX}	Switching Frequency			70		kHz	
η	Full Load Efficiency (115/230 V RMS input)	I _{OUT} = 1 A		74%			

8.2.2 Detailed Design Procedure

This procedure outlines the steps to design a constant-voltage, constant-current flyback converter using the UCC28720 controller. Refer to the [Figure 20](#) for component names and network locations. The design procedure equations use terms that are defined below.

8.2.2.1 Stand-by Power Estimate

Assuming no-load stand-by power is a critical design parameter, determine estimated no-load power based on target converter maximum switching frequency and output power rating.

The following equation estimates the stand-by power of the converter.

$$P_{SB_CONV} = \frac{P_{OUT} \times f_{MIN}}{\eta_{SB} \times K_{AM}^2 \times f_{MAX}} \quad (7)$$

For a typical USB charger application, the bias power during no-load is approximately 2.5 mW. This is based on 25-V VDD and 100-μA bias current. The output preload resistor can be estimated by V_{OCV} and the difference in the converter stand-by power and the bias power. The equation for output preload resistance accounts for bias power estimated at 2.5 mW.

$$R_{PL} = \frac{V_{OCV}^2}{P_{SB_CONV} - 2.5 \text{ mW}} \quad (8)$$

The capacitor bulk voltage for the loss estimation is the highest voltage for the stand-by power measurement, typically 325 V_{DC}.

For the total stand-by power estimation add an estimated 2.5 mW for snubber loss to the converter stand-by power loss.

$$P_{SB} = P_{SB_CONV} + 2.5 \text{ mW} \quad (9)$$

8.2.2.2 Input Bulk Capacitance and Minimum Bulk Voltage

Determine the minimum voltage on the input capacitance, C_{B1} and C_{B2} total, in order to determine the maximum N_p to N_s turns ratio of the transformer. The input power of the converter based on target full-load efficiency, minimum input RMS voltage, and minimum AC input frequency are used to determine the input capacitance requirement.

Maximum input power is determined based on V_{OCV} , I_{OCC} , and the full-load efficiency target.

$$P_{IN} = \frac{V_{OCV} \times I_{OCC}}{\eta} \quad (10)$$

The below equation provides an accurate solution for input capacitance based on a target minimum bulk capacitor voltage. To target a given input capacitance value, iterate the minimum capacitor voltage to achieve the target capacitance.

$$C_{BULK} = \frac{2P_{IN} \times \left(0.25 + \frac{1}{2\pi} \times \arcsin \left(\frac{V_{BULK(min)}}{\sqrt{2} \times V_{IN(min)}} \right) \right)}{\left(2V_{IN(min)}^2 - V_{BULK(min)}^2 \right) \times f_{LINE}} \quad (11)$$

8.2.2.3 Transformer Turns Ratio, Inductance, Primary-Peak Current

The maximum primary-to-secondary turns ratio can be determined by the target maximum switching frequency at full load, the minimum input capacitor bulk voltage, and the estimated DCM quasi-resonant time.

Initially determine the maximum available total duty cycle of the on time and secondary conduction time based on target switching frequency and DCM resonant time. For DCM resonant time, assume 500 kHz if you do not have an estimate from previous designs. For the transition mode operation limit, the period required from the end of secondary current conduction to the first valley of the V_{CE} voltage is $\frac{1}{2}$ of the DCM resonant period, or 1 μ s assuming 500-kHz resonant frequency. D_{MAX} can be determined using the equation below.

$$D_{MAX} = 1 - \left(\frac{t_R}{2} \times f_{MAX} \right) - D_{MAGCC} \quad (12)$$

Once D_{MAX} is known, the maximum turns ratio of the primary to secondary can be determined with the equation below. D_{MAGCC} is defined as the secondary diode conduction duty cycle during constant-current, CC, operation. It is set internally by the UCC28720 at 0.425. The total voltage on the secondary winding needs to be determined; which is the sum of V_{OCV} , the secondary rectifier V_F , and the cable compensation voltage (V_{OCBC}). For the 5-V USB charger applications, a turns ratio range of 13 to 15 is typically used.

$$N_{PS(max)} = \frac{D_{MAX} \times V_{BULK(min)}}{D_{MAGCC} \times (V_{OCV} + V_F + V_{OCBC})} \quad (13)$$

Once an optimum turns ratio is determined from a detailed transformer design, use this ratio for the following parameters.

The UCC28720 constant-current regulation is achieved by maintaining a maximum D_{MAG} duty cycle of 0.425 at the maximum primary current setting. The transformer turns ratio and constant-current regulating voltage determine the current sense resistor for a target constant current.

Since not all of the energy stored in the transformer is transferred to the secondary, a transformer efficiency term is included. This efficiency number includes the core and winding losses, leakage inductance ratio, and bias power ratio to rated output power. For a 5-V, 1-A charger example, bias power of 1.5% is a good estimate. An overall transformer efficiency of 0.9 is a good estimate to include 3.5% leakage inductance, 5% core and winding loss, and 1.5% bias power.

$$R_{CS} = \frac{V_{CCR} \times N_{PS}}{2I_{OCC}} \times \sqrt{\eta_{XFMR}} \quad (14)$$

The primary transformer inductance can be calculated using the standard energy storage equation for flyback transformers. Primary current, maximum switching frequency and output and transformer power losses are included in the equation below. Initially determine transformer primary current.

Primary current is simply the maximum current sense threshold divided by the current sense resistance.

$$I_{PP(max)} = \frac{V_{CST(max)}}{R_{CS}} \quad (15)$$

$$L_P = \frac{2(V_{OCV} + V_F + V_{OCBC}) \times I_{OCC}}{\eta_{XFMR} \times I_{PP(max)}^2 \times f_{MAX}} \quad (16)$$

The secondary winding to auxiliary winding transformer turns ratio (N_{AS}) is determined by the lowest target operating output voltage in constant-current regulation and the VDD UVLO of the UCC28720. There is additional energy supplied to VDD from the transformer leakage inductance energy which allows a lower turns ratio to be used in many designs.

$$N_{AS} = \frac{V_{DD(off)} + V_{FA}}{V_{OCC} + V_F} \quad (17)$$

8.2.2.4 Transformer Parameter Verification

The transformer turns ratio selected affects the transistor V_C and secondary rectifier reverse voltage so these should be reviewed. The UCC28720 does require a minimum on time of the transistor (t_{ON}) and minimum D_{MAG} time (t_{DMAG}) of the secondary rectifier in the high line, minimum load condition. The selection of f_{MAX} , L_P and R_{CS} affects the minimum t_{ON} and t_{DMAG} .

The secondary rectifier and transistor voltage stress can be determined by the equations below.

$$V_{REV} = \frac{V_{IN(max)} \times \sqrt{2}}{N_{PS}} + V_{OCV} + V_{OCBC} \quad (18)$$

For the transistor V_C voltage stress, an estimated leakage inductance voltage spike (V_{LK}) needs to be included.

$$V_{CPK} = (V_{IN(max)} \times \sqrt{2}) + (V_{OCV} + V_F + V_{OCBC}) \times N_{PS} + V_{LK} \quad (19)$$

Equation 20 and Equation 21 are used to determine if the minimum t_{ON} target of 300 ns and minimum t_{DMAG} target of 1.2 μ s is achieved.

$$t_{ON(min)} = \frac{L_P}{V_{IN(max)} \times \sqrt{2}} \times \frac{I_{PP(max)} \times V_{CST(min)}}{V_{CST(max)}} \quad (20)$$

$$t_{DMAG(min)} = \frac{t_{ON} \times V_{IN(max)} \times \sqrt{2}}{N_{PS} \times (V_{OCV} + V_F)} \quad (21)$$

8.2.2.5 Output Capacitance

The output capacitance value is typically determined by the transient response requirement from no-load. For example, in some USB charger applications there is a requirement to maintain a minimum V_O of 4.1 V with a load-step transient of 0 mA to 500 mA. The equation below assumes that the switching frequency can be at the UCC28720 minimum of $f_{SW(min)}$.

$$C_{OUT} = \frac{I_{TRAN} \left(\frac{1}{f_{SW(min)}} + 150 \mu s \right)}{V_{O\Delta}} \quad (22)$$

Another consideration of the output capacitor(s) is the ripple voltage requirement which is reviewed based on secondary peak current and ESR. A margin of 20% is added to the capacitor ESR requirement in the equation below.

$$R_{ESR} = \frac{V_{RIPPLE} \times 0.8}{I_{PP(max)} \times N_{PS}} \quad (23)$$

8.2.2.6 VDD Capacitance, C_{DD}

The capacitance on VDD needs to supply the device operating current until the output of the converter reaches the target minimum operating voltage in constant-current regulation. At this time the auxiliary winding can sustain the voltage to the UCC28720. The total output current available to the load and to charge the output capacitors is the constant-current regulation target. The equation below assumes the output current of the flyback is available to charge the output capacitance until the minimum output voltage is achieved. There is 1 V of margin added to VDD in the calculation.

$$C_{DD} = \frac{\left(I_{RUN} + I_{DRS(max)} \times (1 - D_{magcc}) \right) \times \frac{C_{OUT} \times V_{OCC}}{I_{OCC}}}{(V_{DD(on)} - V_{DD(off)}) - 1 \text{ V}} \quad (24)$$

8.2.2.7 VS Resistor Divider, Line Compensation, and Cable Compensation

The VS divider resistors determine the output voltage regulation point of the flyback converter, also the high-side divider resistor (R_{S1}) determines the line voltage at which the controller enables continuous DRV operation. R_{S1} is initially determined based on transformer auxiliary to primary turns ratio and desired input voltage operating threshold.

$$R_{S1} = \frac{V_{IN(run)} \times \sqrt{2}}{N_{PA} \times I_{VSL(run)}} \quad (25)$$

The low-side VS pin resistor is selected based on desired V_O regulation voltage.

$$R_{S2} = \frac{R_{S1} \times V_{VSR}}{N_{AS} \times (V_{OCV} + V_F) - V_{VSR}} \quad (26)$$

The UCC28720 can maintain tight constant-current regulation over input line by utilizing the line compensation feature. The line compensation resistor (R_{LC}) value is determined by current flowing in R_{S1} and expected base drive and transistor turn-off delay. Assume a 50-ns internal delay in the UCC28720.

$$R_{LC} = \frac{K_{LC} \times R_{S1} \times R_{CS} \times t_D \times N_{PA}}{L_P} \quad (27)$$

The UCC28720 has adjustable cable drop compensation. The resistance for the desired compensation level at the output terminals can be determined using [Equation 28](#).

$$R_{CBC} = \frac{V_{CBC(max)} \times 3 \text{ k}\Omega \times (V_{OCV} + V_F)}{V_{VSR} \times V_{OCBC}} - 28 \text{ k}\Omega \quad (28)$$

8.2.3 Application Curves

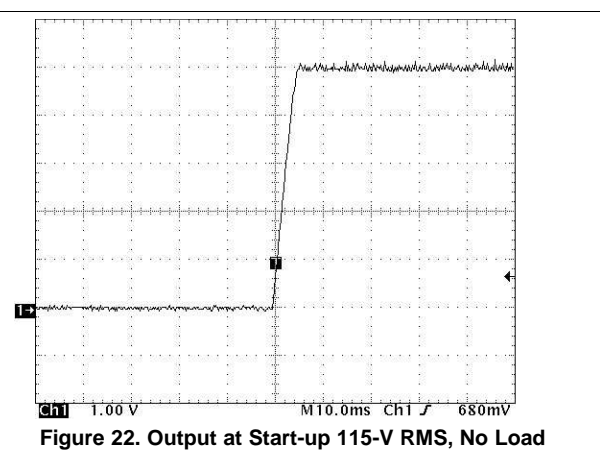
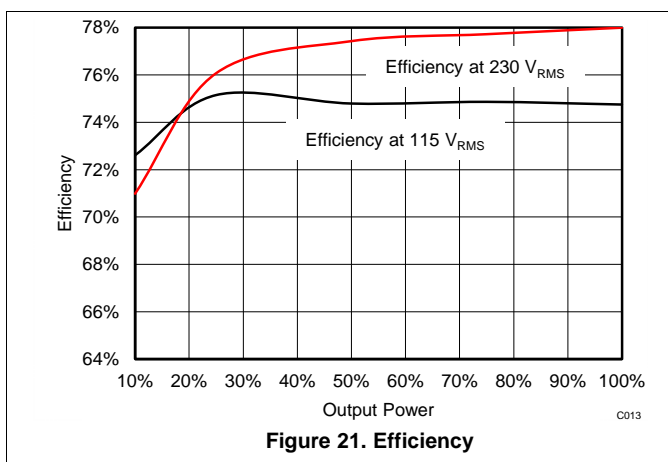

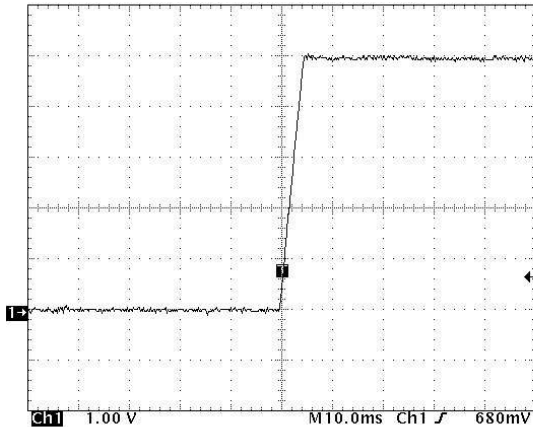

Figure 23. Output at Start-up 115-V RMS, 5-Ω Load

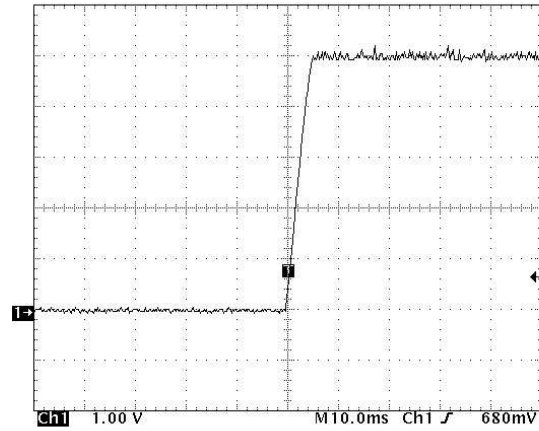

Figure 24. Output at Start-up 230-V RMS, No Load

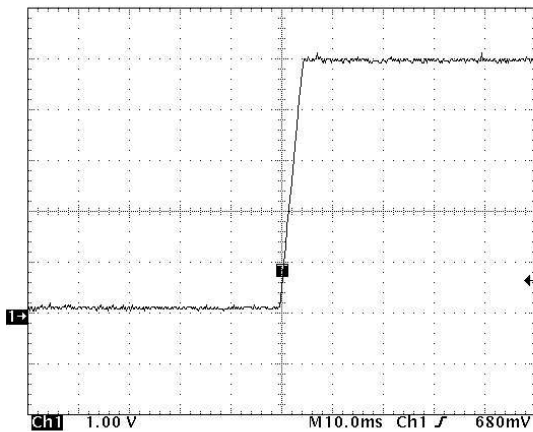
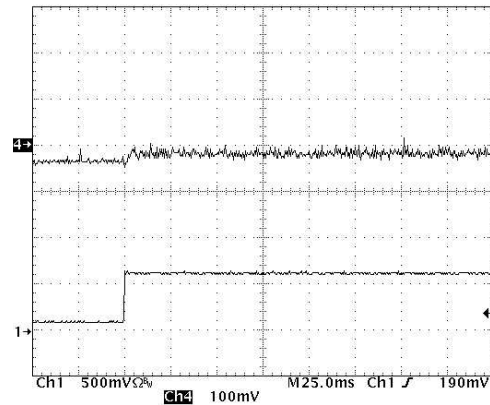
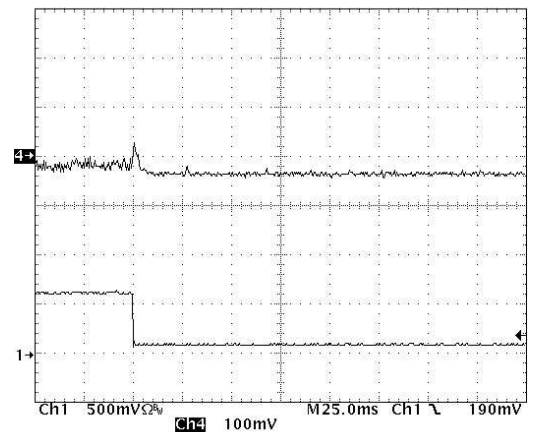

Figure 25. Output at Start-up 230-V RMS, 5-Ω Load



CH4 = V_{OCV} with 5-V offset, CH1 = I_{OUT}
Figure 26. Load Transients (0.1- to 0.6-A Load Step)



CH4 = V_{OCV} with 5-V offset, CH1 = I_{OUT}
Figure 27. Load Transient (0.6- to 0.1-A Load Step)

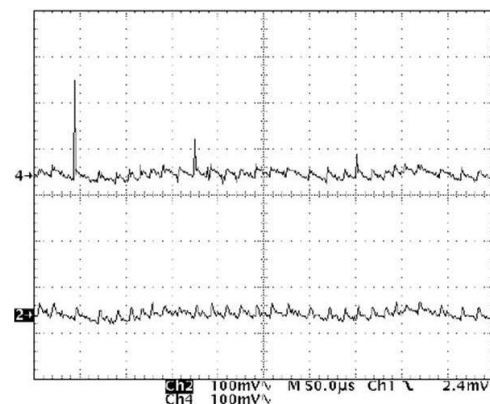

CH2 = V_{OCV} at the end of 3M cable and 1 μ F of capacitance.
The output ripple at the end of the cables is less than 50 mV.
Figure 28. Output Ripple CH4 = V_{OCV} at Supply Output

9 Power Supply Recommendations

The UCC28720 is intended for AC/DC adapters and chargers with input voltage range of 85 VAC_(rms) to 265 VAC_(rms) using Flyback topology. It can be used in other applications and converter topologies with different input voltages. Be sure that all voltages and currents are within the recommended operating conditions and absolute maximum ratings of the device. To maintain output current regulation over the entire input voltage range, design the converter to operate close to f_{MAX} when in full-load conditions. To improve thermal performance increase the copper area connected to GND pins.

10 Layout

10.1 Layout Guidelines

- High frequency bypass Capacitor C5 must be placed across Pin 1 and 4 as close as you can get it to the pins.
- Resistor R4 and C5 form a low pass filter and the connection of R4 and C5 must be as close to the VDD pin as possible.
- The VS pin controls the output voltage through the transformer turns ratio and the voltage divider of R5 and R11. Note the trace length between the R5, R11 and VS pin should be as short as possible to reduce or eliminate possible EMI coupling.
- The IC ground and power ground must meet at the bulk capacitor's (C6 and C7) return. Try to ensure that high frequency/high current from the power stage does not go through the signal ground.
 - o The high frequency/high current path that you need to be cautious of on the primary is C7 +, T1 (P5, P3), Q1d, Q1s, R8 to the return of C6 and C7. Try to keep all high current loops as short as possible.
- Try to keep all high current loops as short as possible.
- Keep all high current/high frequency traces away from or perpendicular to other traces in the design.
- Traces on the voltage clamp formed by D1, R2, D3 and C2 as short as possible.
- C6 return needs to be as close to the bulk capacitor supply as possible. This reduces the magnitude of dv/dt caused by large di/dt.
- Avoid mounting semiconductors under magnetics.

10.2 Layout Example

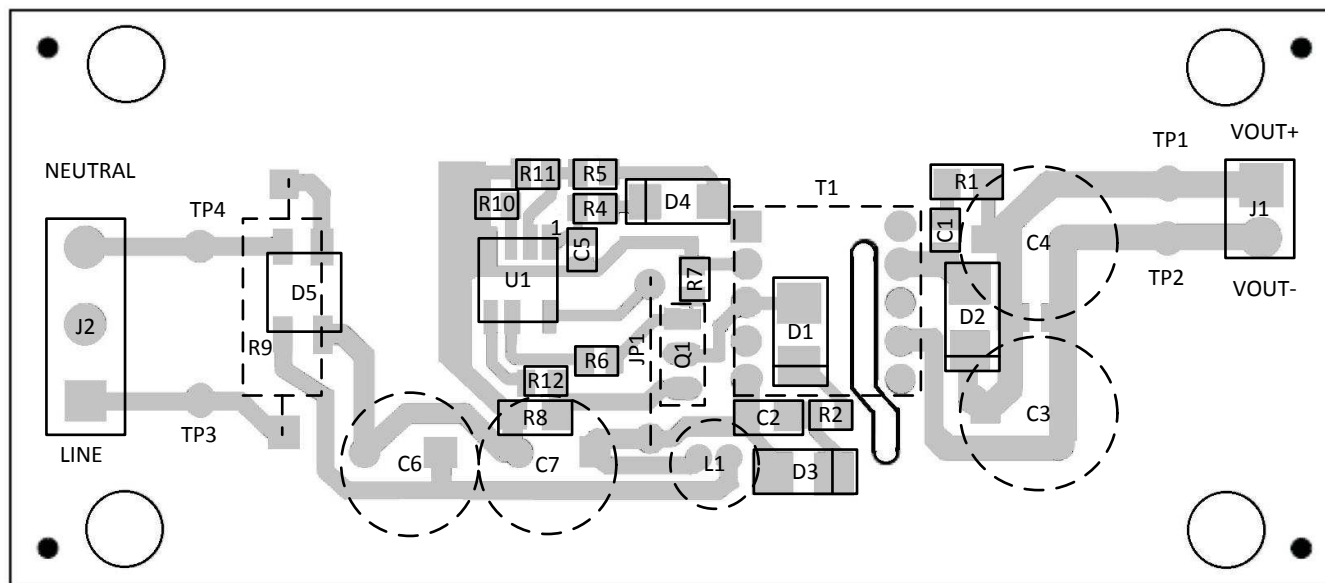

Figure 29. Layout

Layout Example (continued)

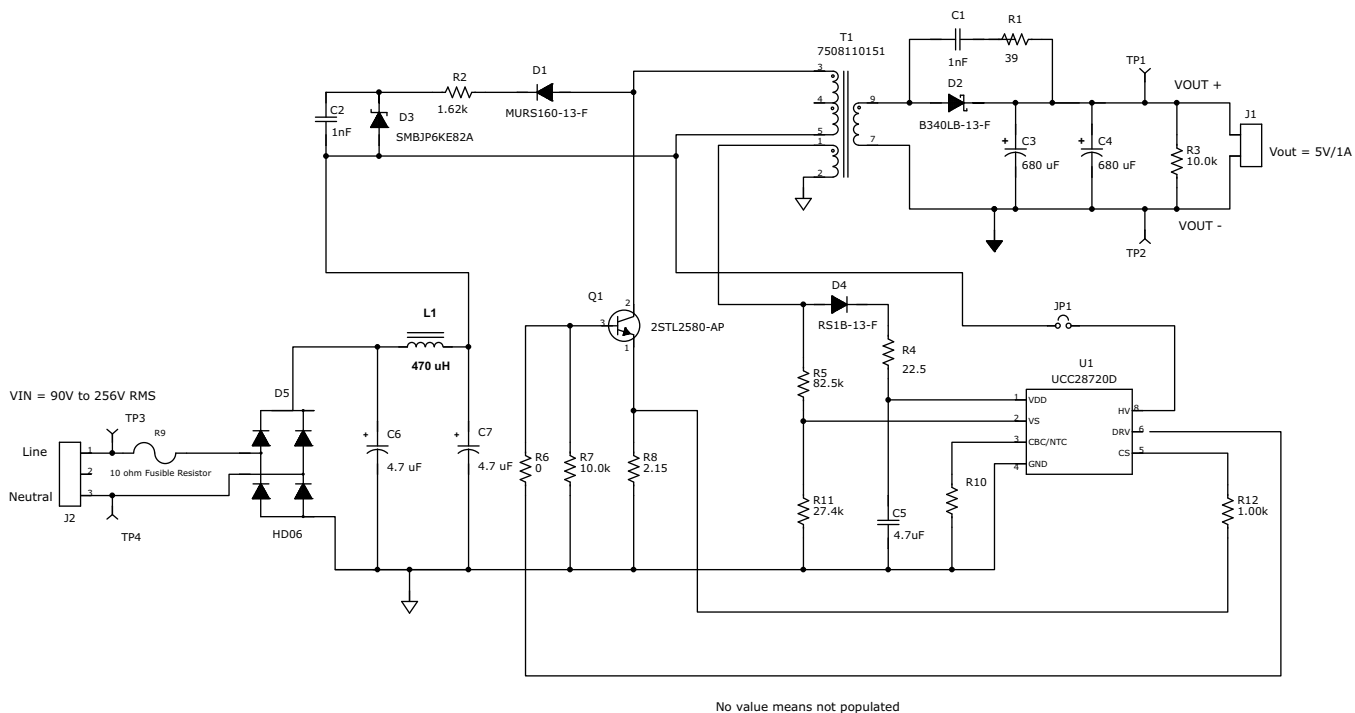

Figure 30. 5W USB Adapter Schematic

11 Device and Documentation Support

11.1 Device Support

11.1.1 Device Nomenclature

11.1.1.1 Definition of Terms

11.1.1.1.1 Capacitance Terms in Farads

- C_{BULK} : total input capacitance of C_{B1} and C_{B2} .
- C_{DD} : minimum required capacitance on the VDD pin.
- C_{OUT} : minimum output capacitance required.

11.1.1.1.2 Duty Cycle Terms

- D_{MAGCC} : secondary diode conduction duty cycle in CC, 0.425.
- D_{MAX} : transistor on-time duty cycle.

11.1.1.1.3 Frequency Terms in Hertz

- f_{LINE} : minimum line frequency.
- f_{MAX} : target full-load maximum switching frequency of the converter.
- f_{MIN} : minimum switching frequency of the converter, add 15% margin over the $f_{SW(min)}$ limit of the device.
- $f_{SW(min)}$: minimum switching frequency (see [Electrical Characteristics](#)).

11.1.1.1.4 Current Terms in Amperes

- I_{OCC} : converter output constant-current target.
- $I_{PP(max)}$: maximum transformer primary current.
- I_{START} : start-up bias supply current (see [Electrical Characteristics](#)).
- I_{TRAN} : required positive load-step current.
- $I_{VSL(run)}$: VS pin run current (see [Electrical Characteristics](#)).
- I_{DRS} : Driver source current (see [Electrical Characteristics](#)).

11.1.1.1.5 Current and Voltage Scaling Terms

- K_{AM} : maximum-to-minimum peak primary current ratio (see [Electrical Characteristics](#)).
- K_{LC} : current-scaling constant (see [Electrical Characteristics](#)).

11.1.1.1.6 Transformer Terms

- L_P : transformer primary inductance.
- N_{AS} : transformer auxiliary-to-secondary turns ratio.
- N_{PA} : transformer primary-to-auxiliary turns ratio.
- N_{PS} : transformer primary-to-secondary turns ratio.

11.1.1.1.7 Power Terms in Watts

- P_{IN} : converter maximum input power.
- P_{OUT} : full-load output power of the converter.
- P_{SB} : total stand-by power.
- P_{SB_CONV} : P_{SB} minus start-up resistor and snubber losses.

11.1.1.1.8 Resistance Terms in Ω

- R_{CS} : primary current programming resistance.
- R_{ESR} : total ESR of the output capacitor(s).
- R_{PL} : preload resistance on the output of the converter.
- R_{S1} : high-side VS pin resistance.
- R_{S2} : low-side VS pin resistance.

Device Support (continued)

11.1.1.1.9 Timing Terms in Seconds

- t_D : current-sense delay including transistor turn-off delay; add 50 ns to transistor delay.
- $t_{DMAG(min)}$: minimum secondary rectifier conduction time.
- $t_{ON(min)}$: minimum transistor on time.
- t_R : resonant frequency during the DCM (discontinuous conduction mode) time.

11.1.1.1.10 Voltage Terms in Volts

- V_{BLK} : highest bulk capacitor voltage for stand-by power measurement.
- $V_{BULK(min)}$: minimum voltage on C_{B1} and C_{B2} at full power.
- V_{OCBC} : target cable compensation voltage at the output terminals.
- $V_{CBC(max)}$: maximum voltage at the CBC pin at the maximum converter output current (see [Electrical Characteristics](#)).
- V_{CCR} : constant-current regulating voltage (see [Electrical Characteristics](#)).
- $V_{CST(max)}$: CS pin maximum current-sense threshold (see [Electrical Characteristics](#)).
- $V_{CST(min)}$: CS pin minimum current-sense threshold (see [Electrical Characteristics](#)).
- $V_{DD(off)}$: UVLO turn-off voltage (see [Electrical Characteristics](#)).
- $V_{DD(on)}$: UVLO turn-on voltage (see [Electrical Characteristics](#)).
- $V_{OΔ}$: output voltage drop allowed during the load-step transient.
- V_{CPK} : peak transistor collector to emitter voltage at high line.
- V_F : secondary rectifier forward voltage drop at near-zero current.
- V_{FA} : auxiliary rectifier forward voltage drop.
- V_{LK} : estimated leakage inductance energy reset voltage.
- V_{OCV} : regulated output voltage of the converter.
- V_{OCC} : target lowest converter output voltage in constant-current regulation.
- V_{REV} : peak reverse voltage on the secondary rectifier.
- V_{RIPPLE} : output peak-to-peak ripple voltage at full-load.
- V_{VSR} : CV regulating level at the VS input (see [Electrical Characteristics](#)).

11.1.1.1.11 AC Voltage Terms in V_{RMS}

- $V_{IN(max)}$: maximum input voltage to the converter.
- $V_{IN(min)}$: minimum input voltage to the converter.
- $V_{IN(run)}$: converter input start-up (run) voltage.

11.1.1.1.12 Efficiency Terms

- η_{SB} : estimated efficiency of the converter at no-load condition, not including start-up resistance or bias losses. For a 5-V USB charger application, 60% to 65% is a good initial estimate.
- η : converter overall efficiency.
- η_{XFMR} : transformer primary-to-secondary power transfer efficiency.

11.2 Documentation Support

11.2.1 Related Documentation

See the following: *Using the UCC28720EVM-212, Evaluation Module*, [SLUUA92](#).

11.3 Community Resources

The following links connect to TI community resources. Linked contents are provided "AS IS" by the respective contributors. They do not constitute TI specifications and do not necessarily reflect TI's views; see TI's [Terms of Use](#).

TI E2E™ Online Community *TI's Engineer-to-Engineer (E2E) Community*. Created to foster collaboration among engineers. At e2e.ti.com, you can ask questions, share knowledge, explore ideas and help solve problems with fellow engineers.

Design Support *TI's Design Support* Quickly find helpful E2E forums along with design support tools and contact information for technical support.

11.4 Trademarks

E2E is a trademark of Texas Instruments.
All other trademarks are the property of their respective owners.

11.5 Electrostatic Discharge Caution



These devices have limited built-in ESD protection. The leads should be shorted together or the device placed in conductive foam during storage or handling to prevent electrostatic damage to the MOS gates.

11.6 Glossary

[SLYZ022](#) — *TI Glossary*.

This glossary lists and explains terms, acronyms, and definitions.

12 Mechanical, Packaging, and Orderable Information

The following pages include mechanical, packaging, and orderable information. This information is the most current data available for the designated devices. This data is subject to change without notice and revision of this document. For browser-based versions of this data sheet, refer to the left-hand navigation.

PACKAGING INFORMATION

Orderable Device	Status (1)	Package Type	Package Drawing	Pins	Package Qty	Eco Plan (2)	Lead/Ball Finish (6)	MSL Peak Temp (3)	Op Temp (°C)	Device Marking (4/5)	Samples
UCC28720D	ACTIVE	SOIC	D	7	75	Green (RoHS & no Sb/Br)	CU NIPDAU	Level-1-260C-UNLIM	-40 to 125	U28720	Samples
UCC28720DR	ACTIVE	SOIC	D	7	2500	Green (RoHS & no Sb/Br)	CU NIPDAU	Level-1-260C-UNLIM	-40 to 125	U28720	Samples

(1) The marketing status values are defined as follows:

ACTIVE: Product device recommended for new designs.

LIFEBUY: TI has announced that the device will be discontinued, and a lifetime-buy period is in effect.

NRND: Not recommended for new designs. Device is in production to support existing customers, but TI does not recommend using this part in a new design.

PREVIEW: Device has been announced but is not in production. Samples may or may not be available.

OBsolete: TI has discontinued the production of the device.

(2) Eco Plan - The planned eco-friendly classification: Pb-Free (RoHS), Pb-Free (RoHS Exempt), or Green (RoHS & no Sb/Br) - please check <http://www.ti.com/productcontent> for the latest availability information and additional product content details.

TBD: The Pb-Free/Green conversion plan has not been defined.

Pb-Free (RoHS): TI's terms "Lead-Free" or "Pb-Free" mean semiconductor products that are compatible with the current RoHS requirements for all 6 substances, including the requirement that lead not exceed 0.1% by weight in homogeneous materials. Where designed to be soldered at high temperatures, TI Pb-Free products are suitable for use in specified lead-free processes.

Pb-Free (RoHS Exempt): This component has a RoHS exemption for either 1) lead-based flip-chip solder bumps used between the die and package, or 2) lead-based die adhesive used between the die and leadframe. The component is otherwise considered Pb-Free (RoHS compatible) as defined above.

Green (RoHS & no Sb/Br): TI defines "Green" to mean Pb-Free (RoHS compatible), and free of Bromine (Br) and Antimony (Sb) based flame retardants (Br or Sb do not exceed 0.1% by weight in homogeneous material)

(3) MSL, Peak Temp. - The Moisture Sensitivity Level rating according to the JEDEC industry standard classifications, and peak solder temperature.

(4) There may be additional marking, which relates to the logo, the lot trace code information, or the environmental category on the device.

(5) Multiple Device Markings will be inside parentheses. Only one Device Marking contained in parentheses and separated by a "~" will appear on a device. If a line is indented then it is a continuation of the previous line and the two combined represent the entire Device Marking for that device.

(6) Lead/Ball Finish - Orderable Devices may have multiple material finish options. Finish options are separated by a vertical ruled line. Lead/Ball Finish values may wrap to two lines if the finish value exceeds the maximum column width.

Important Information and Disclaimer: The information provided on this page represents TI's knowledge and belief as of the date that it is provided. TI bases its knowledge and belief on information provided by third parties, and makes no representation or warranty as to the accuracy of such information. Efforts are underway to better integrate information from third parties. TI has taken and continues to take reasonable steps to provide representative and accurate information but may not have conducted destructive testing or chemical analysis on incoming materials and chemicals. TI and TI suppliers consider certain information to be proprietary, and thus CAS numbers and other limited information may not be available for release.

In no event shall TI's liability arising out of such information exceed the total purchase price of the TI part(s) at issue in this document sold by TI to Customer on an annual basis.

TAPE AND REEL INFORMATION



QUADRANT ASSIGNMENTS FOR PIN 1 ORIENTATION IN TAPE



*All dimensions are nominal

Device	Package Type	Package Drawing	Pins	SPQ	Reel Diameter (mm)	Reel Width W1 (mm)	A0 (mm)	B0 (mm)	K0 (mm)	P1 (mm)	W (mm)	Pin1 Quadrant
UCC28720DR	SOIC	D	7	2500	330.0	12.4	6.4	5.2	2.1	8.0	12.0	Q1

TAPE AND REEL BOX DIMENSIONS



*All dimensions are nominal

Device	Package Type	Package Drawing	Pins	SPQ	Length (mm)	Width (mm)	Height (mm)
UCC28720DR	SOIC	D	7	2500	367.0	367.0	35.0

D (R-PDSO-G7)

PLASTIC SMALL OUTLINE

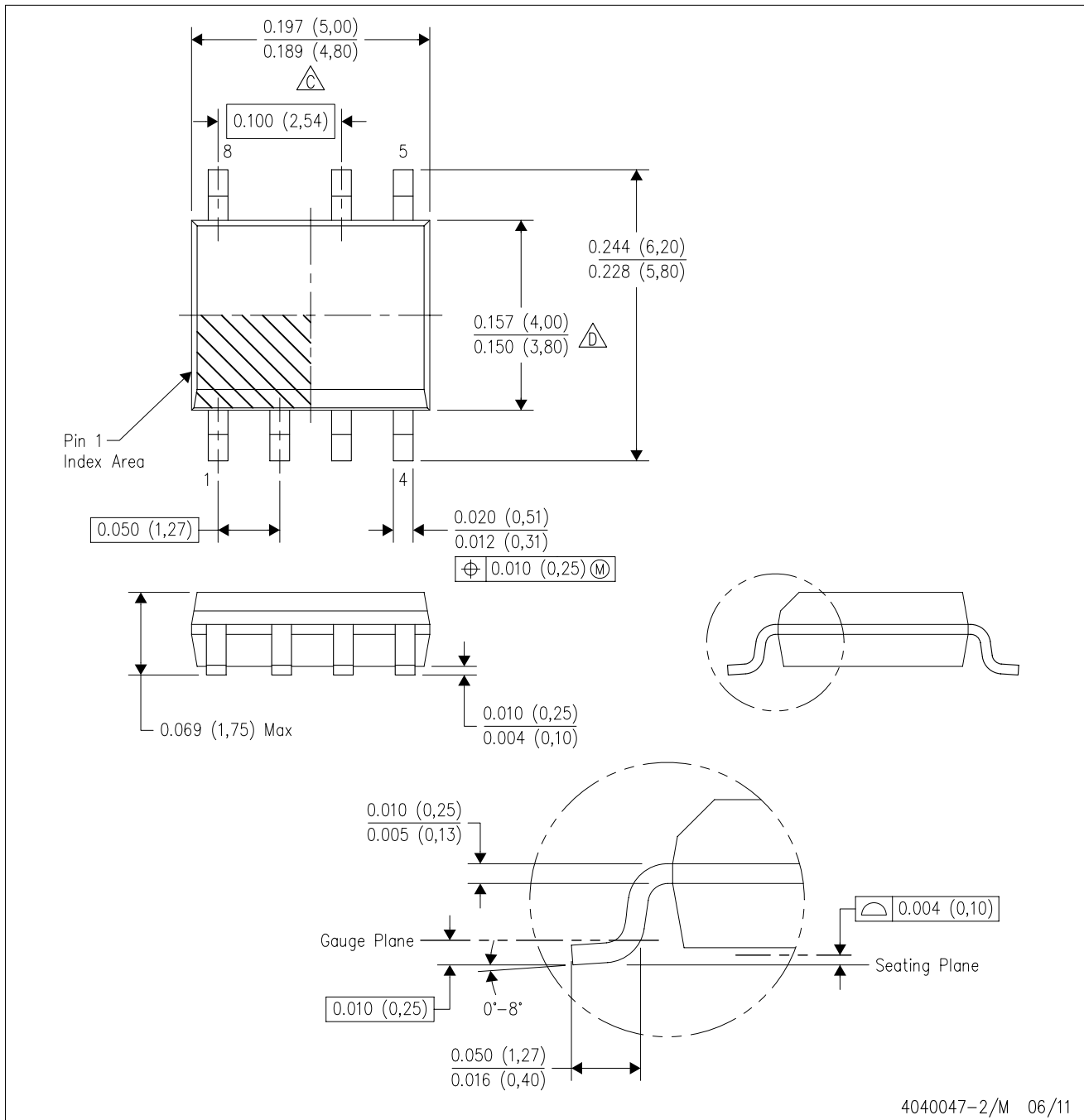

- NOTES:
- A. All linear dimensions are in inches (millimeters).
 - B. This drawing is subject to change without notice.
 - C. Body length does not include mold flash, protrusions, or gate burrs. Mold flash, protrusions, or gate burrs shall not exceed 0.006 (0,15) each side.
 - D. Body width does not include interlead flash. Interlead flash shall not exceed 0.017 (0,43) each side.
 - E. Reference JEDEC MS-012 variation AA.

IMPORTANT NOTICE

Texas Instruments Incorporated and its subsidiaries (TI) reserve the right to make corrections, enhancements, improvements and other changes to its semiconductor products and services per JESD46, latest issue, and to discontinue any product or service per JESD48, latest issue. Buyers should obtain the latest relevant information before placing orders and should verify that such information is current and complete. All semiconductor products (also referred to herein as "components") are sold subject to TI's terms and conditions of sale supplied at the time of order acknowledgment.

TI warrants performance of its components to the specifications applicable at the time of sale, in accordance with the warranty in TI's terms and conditions of sale of semiconductor products. Testing and other quality control techniques are used to the extent TI deems necessary to support this warranty. Except where mandated by applicable law, testing of all parameters of each component is not necessarily performed.

TI assumes no liability for applications assistance or the design of Buyers' products. Buyers are responsible for their products and applications using TI components. To minimize the risks associated with Buyers' products and applications, Buyers should provide adequate design and operating safeguards.

TI does not warrant or represent that any license, either express or implied, is granted under any patent right, copyright, mask work right, or other intellectual property right relating to any combination, machine, or process in which TI components or services are used. Information published by TI regarding third-party products or services does not constitute a license to use such products or services or a warranty or endorsement thereof. Use of such information may require a license from a third party under the patents or other intellectual property of the third party, or a license from TI under the patents or other intellectual property of TI.

Reproduction of significant portions of TI information in TI data books or data sheets is permissible only if reproduction is without alteration and is accompanied by all associated warranties, conditions, limitations, and notices. TI is not responsible or liable for such altered documentation. Information of third parties may be subject to additional restrictions.

Resale of TI components or services with statements different from or beyond the parameters stated by TI for that component or service voids all express and any implied warranties for the associated TI component or service and is an unfair and deceptive business practice. TI is not responsible or liable for any such statements.

Buyer acknowledges and agrees that it is solely responsible for compliance with all legal, regulatory and safety-related requirements concerning its products, and any use of TI components in its applications, notwithstanding any applications-related information or support that may be provided by TI. Buyer represents and agrees that it has all the necessary expertise to create and implement safeguards which anticipate dangerous consequences of failures, monitor failures and their consequences, lessen the likelihood of failures that might cause harm and take appropriate remedial actions. Buyer will fully indemnify TI and its representatives against any damages arising out of the use of any TI components in safety-critical applications.

In some cases, TI components may be promoted specifically to facilitate safety-related applications. With such components, TI's goal is to help enable customers to design and create their own end-product solutions that meet applicable functional safety standards and requirements. Nonetheless, such components are subject to these terms.

No TI components are authorized for use in FDA Class III (or similar life-critical medical equipment) unless authorized officers of the parties have executed a special agreement specifically governing such use.

Only those TI components which TI has specifically designated as military grade or "enhanced plastic" are designed and intended for use in military/aerospace applications or environments. Buyer acknowledges and agrees that any military or aerospace use of TI components which have **not** been so designated is solely at the Buyer's risk, and that Buyer is solely responsible for compliance with all legal and regulatory requirements in connection with such use.

TI has specifically designated certain components as meeting ISO/TS16949 requirements, mainly for automotive use. In any case of use of non-designated products, TI will not be responsible for any failure to meet ISO/TS16949.

Products

Audio	www.ti.com/audio
Amplifiers	amplifier.ti.com
Data Converters	dataconverter.ti.com
DLP® Products	www.dlp.com
DSP	dsp.ti.com
Clocks and Timers	www.ti.com/clocks
Interface	interface.ti.com
Logic	logic.ti.com
Power Mgmt	power.ti.com
Microcontrollers	microcontroller.ti.com
RFID	www.ti-rfid.com
OMAP Applications Processors	www.ti.com/omap
Wireless Connectivity	www.ti.com/wirelessconnectivity

Applications

Automotive and Transportation	www.ti.com/automotive
Communications and Telecom	www.ti.com/communications
Computers and Peripherals	www.ti.com/computers
Consumer Electronics	www.ti.com/consumer-apps
Energy and Lighting	www.ti.com/energy
Industrial	www.ti.com/industrial
Medical	www.ti.com/medical
Security	www.ti.com/security
Space, Avionics and Defense	www.ti.com/space-avionics-defense
Video and Imaging	www.ti.com/video

TI E2E Community

e2e.ti.com