

1.6V Nanopower Comparator with Internal Reference

FEATURES

- ◆ Improved Electrical Performance over MAX9117-MAX9118
- ◆ Guaranteed to Operate Down to +1.6V
- ◆ Ultra-Low Supply Current: 600nA
- ◆ Internal 1.252V \pm 1% Reference
- ◆ Input Voltage Range Extends 200mV Outside-the-Rails
- ◆ No Phase Reversal for Overdriven Inputs
- ◆ Output Stage: Push-pull (TS9001-1)
Open-Drain (TS9001-2)
- ◆ Crowbar-Current-Free Switching
- ◆ Internal Hysteresis for Clean Switching
- ◆ 5-pin SC70 Packaging

APPLICATIONS

2-Cell Battery Monitoring/Management
 Medical Instruments
 Threshold Detectors/Discriminators
 Sensing at Ground or Supply Line
 Ultra-Low-Power Systems
 Mobile Communications
 Telemetry and Remote Systems

DESCRIPTION

The nanopower TS9001-1/2 analog comparators guarantee +1.6V operation, draw very little supply current, and have robust input stages that can tolerate input voltages beyond the power supply. Both products are the first analog comparator products in the “NanoWatt Analog” high-performance analog integrated circuits portfolio. The TS9001-1/2 draws 600nA of supply current and includes an on-board +1.252V \pm 1% reference. These comparators are also electrically and form-factor identical to the MAX9117 and the MAX9118 family of analog comparators. Both comparators offer a 33% improvement in voltage reference initial accuracy and the TS9001-1 offers 73% higher output current drive.

The TS9001-1's push-pull output drivers were designed to drive 5mA loads from one supply rail to the other supply rail. The TS9001-2's open-drain output stage make it easy to incorporate this analog comparator into systems that operate on different supply voltages. Both devices are available in an ultra-small 5-pin SC70 package.

TYPICAL APPLICATION CIRCUIT

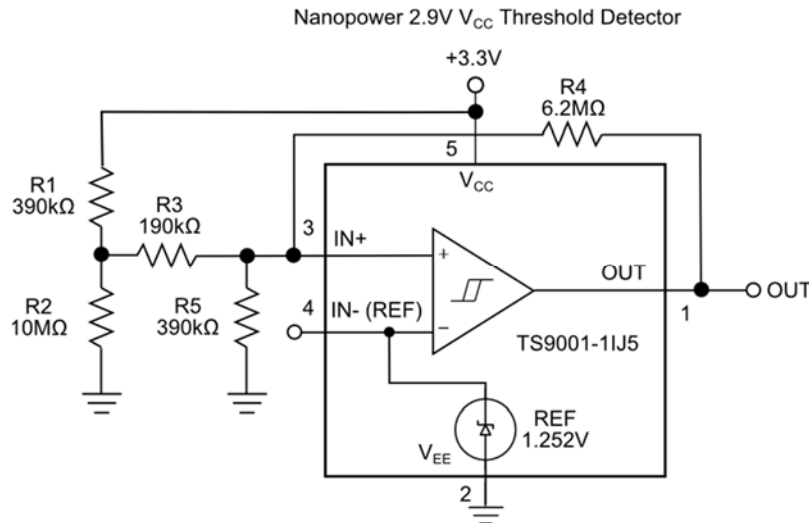

PART	INTERNAL REFERENCE	OUTPUT STAGE	IN-Connection	SUPPLY CURRENT (nA)
TS9001-1	Yes	Push-Pull	REF	600
TS9001-2	Yes	Open-Drain	REF	600

ABSOLUTE MAXIMUM RATINGS

Supply Voltage (V_{CC} to V_{EE}) +6V
 Voltage Inputs ($IN+$, $IN-$, REF) ($V_{EE} - 0.3V$) to ($V_{CC} + 0.3V$)
 Output Voltage
 TS9001-1 ($V_{EE} - 0.3V$) to ($V_{CC} + 0.3V$)
 TS9001-2 ($V_{EE} - 0.3V$) to +6V
 Current Into Input Pins $\pm 20mA$
 Output Current $\pm 50mA$
 Output Short-Circuit Duration 10s

Continuous Power Dissipation ($T_A = +70^\circ C$)
 5-Pin SC70 (Derate 2.5mW/ $^\circ C$ above $+70^\circ C$) 200 mW
 Operating Temperature Range $-40^\circ C$ to $+85^\circ C$
 Junction Temperature $+150^\circ C$
 Storage Temperature Range $-65^\circ C$ to $+150^\circ C$
 Lead Temperature (soldering, 10s) $+300^\circ$

Electrical and thermal stresses beyond those listed under “Absolute Maximum Ratings” may cause permanent damage to the device. These are stress ratings only and functional operation of the device at these or any other condition beyond those indicated in the operational sections of the specifications is not implied. Exposure to any absolute maximum rating conditions for extended periods may affect device reliability and lifetime.

PACKAGE/ORDERING INFORMATION

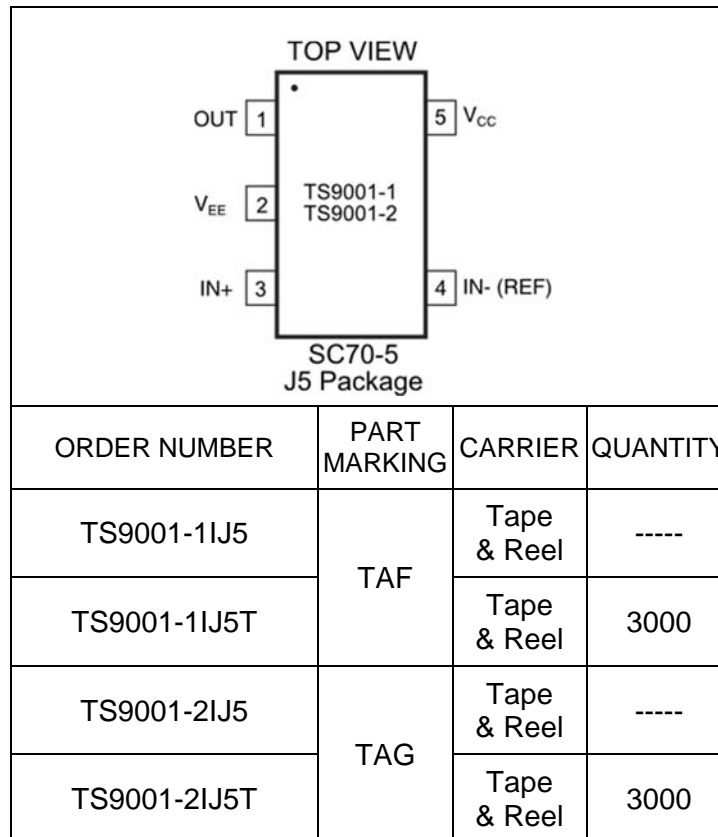

Lead-free Program: Silicon Labs supplies only lead-free packaging.

Please consult Silicon Labs for products specified with wider operating temperature ranges.

ELECTRICAL CHARACTERISTICS: TS9001-1/2

$V_{CC} = +5V$, $V_{EE} = 0V$, $V_{IN+} = V_{REF}$, $T_A = -40^{\circ}C$ to $+85^{\circ}C$, unless otherwise noted. Typical values are at $T_A = +25^{\circ}C$. See Note 1

PARAMETER	SYMBOL	CONDITIONS	MIN	TYP	MAX	UNITS	
Supply Voltage Range	V_{CC}	Inferred from the PSRR test	$T_A = T_{MIN}$ to T_{MAX}	1.6		5.5	V
Supply Current	I_{CC}	$V_{CC} = 1.6V$	$T_A = +25^{\circ}C$		0.6	1	μA
		$V_{CC} = 5V$	$T_A = +25^{\circ}C$		0.68	1.30	
			$T_A = T_{MIN}$ to T_{MAX}			1.60	
IN+ Voltage Range	V_{IN+}	Inferred from the output swing test		$V_{EE} - 0.2$		$V_{CC} + 0.2$	V
Input Offset Voltage	V_{OS}	(Note 2)	$T_A = +25^{\circ}C$		2	5	mV
			$T_A = T_{MIN}$ to T_{MAX}			10	
Input-Referred Hysteresis	V_{HB}	(Note 3)			4		mV
Input Bias Current	I_B	$T_A = +25^{\circ}C$			0.15	1	nA
		$T_A = T_{MIN}$ to T_{MAX}				2	
Power-Supply Rejection Ratio	PSRR	$V_{CC} = 1.6V$ to $5.5V$, $T_A = T_{MIN}$ to T_{MAX}				1	mV/V
Output-Voltage Swing High	$V_{CC} - V_{OH}$	TS9001-1, $V_{CC} = 5V$, $I_{SOURCE} = 5mA$	$T_A = +25^{\circ}C$		200	300	mV
			$T_A = T_{MIN}$ to T_{MAX}			400	
		TS9001-1, $I_{SOURCE} = 1mA$	$V_{CC} = 1.6V$, $T_A = +25^{\circ}C$		100	150	
$V_{CC} = 1.6V$, $T_A = T_{MIN}$ to T_{MAX}				200			
Output-Voltage Swing Low	V_{OL}	$V_{CC} = 5V$, $I_{SINK} = 5mA$	$T_A = +25^{\circ}C$		110	200	mV
			$T_A = T_{MIN}$ to T_{MAX}			300	
		$I_{SINK} = 1mA$	$V_{CC} = 1.6V$, $T_A = +25^{\circ}C$		50	100	
			$V_{CC} = 1.6V$, $T_A = T_{MIN}$ to T_{MAX}			150	
Output Leakage Current	I_{LEAK}	TS9001-2 only, $V_O = 5.5V$		0.002	1	μA	
Output Short-Circuit Current	I_{SC}	Sourcing, $V_O = V_{EE}$	$V_{CC} = 5V$		60		mA
			$V_{CC} = 1.6V$		6		
		Sinking, $V_O = V_{CC}$	$V_{CC} = 5V$		90		
			$V_{CC} = 1.6V$		10		
High-to-Low Propagation Delay (Note 4)	t_{PD-}	$V_{CC} = 1.6V$		12		μs	
		$V_{CC} = 5V$		15			
Low-to-High Propagation Delay (Note 4)	t_{PD+}	TS9001-1 only	$V_{CC} = 1.6V$		25		μs
			$V_{CC} = 5V$		50		
		TS9001-2 only	$V_{CC} = 1.6V$, $R_{PULLUP} = 100k\Omega$		21		
			$V_{CC} = 5V$, $R_{PULLUP} = 100k\Omega$		28		
Rise Time	t_{RISE}	TS9001-1 only, $C_L = 15pF$		3.5		μs	
Fall Time	t_{FALL}	$C_L = 15pF$		2		μs	
Power-Up Time	t_{ON}			1.2		ms	
Reference Voltage	V_{REF}	$T_A = +25^{\circ}C$		1.239	1.252	1.264	V
		$T_A = T_{MIN}$ to T_{MAX}		1.233		1.270	
Reference Voltage Temperature Coefficient	TCV_{REF}			10		ppm/ $^{\circ}C$	
Reference Output Voltage Noise	e_n	$BW = 10Hz$ to $100kHz$		1		mV_{RMS}	
		$BW = 10Hz$ to $100kHz$, $C_{REF} = 1nF$		0.2			
Reference Line Regulation	$\Delta V_{REF} / \Delta V_{CC}$	$V_{CC} = 1.6V$ to $5.5V$		0.1		mV/V	
Reference Load Regulation	$\Delta V_{REF} / \Delta I_{OUT}$	$\Delta I_{OUT} = 10nA$		± 0.2		mV/nA	

Note 1: All specifications are 100% tested at $T_A = +25^{\circ}C$. Specification limits over temperature ($T_A = T_{MIN}$ to T_{MAX}) are guaranteed by device characterization, not production tested.

Note 2: V_{OS} is defined as the center of the hysteresis band at the input.

Note 3: The hysteresis-related trip points are defined by the edges of the hysteresis band and measured with respect to the center of the hysteresis band (i.e., V_{OS}). See Figure 2.

Note 4: The propagation delays are specified with an input overdrive ($V_{OVERDRIVE}$) of 100mV and an output load capacitance of $C_L = 15pF$. $V_{OVERDRIVE}$ is defined above and is beyond the offset voltage and hysteresis of the comparator input. Reference voltage error should also be included.

TYPICAL PERFORMANCE CHARACTERISTICS

$V_{CC} = +5V$; $V_{EE} = 0V$; $C_L = 15pF$; $V_{OVERDRIVE} = 100mV$; $T_A = +25^\circ C$, unless otherwise noted.

Supply Current vs Supply Voltage and Temperature

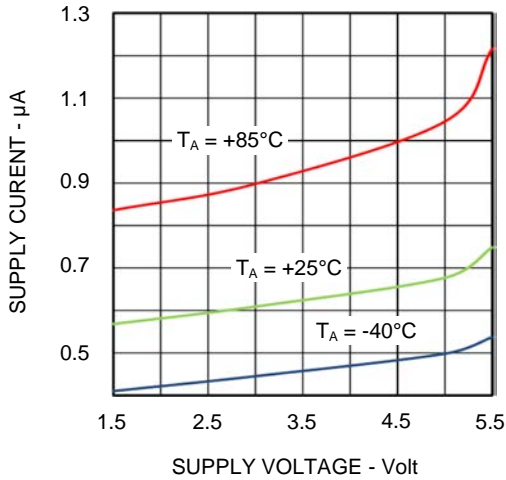

Supply Current vs Temperature

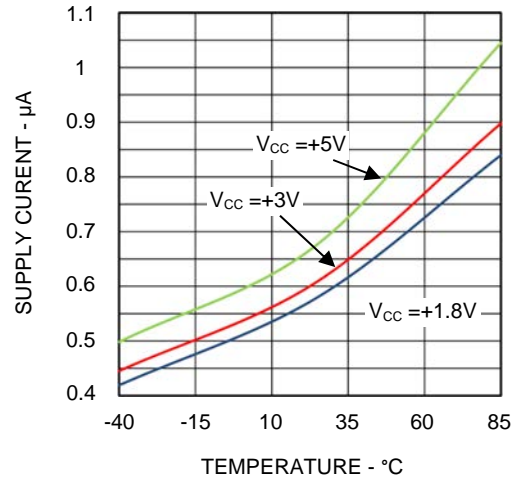

Supply Current vs Output Transition Frequency

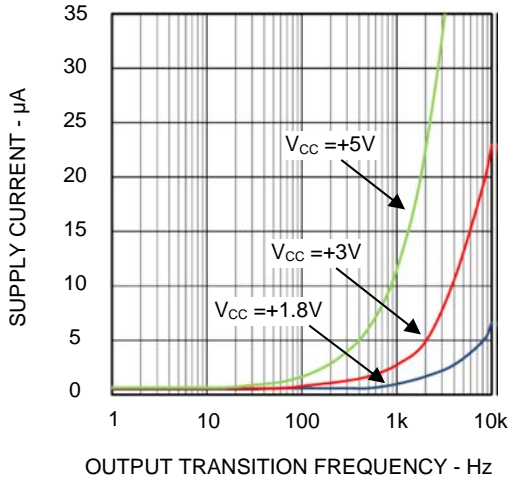

Output Voltage Low vs. Sink Current

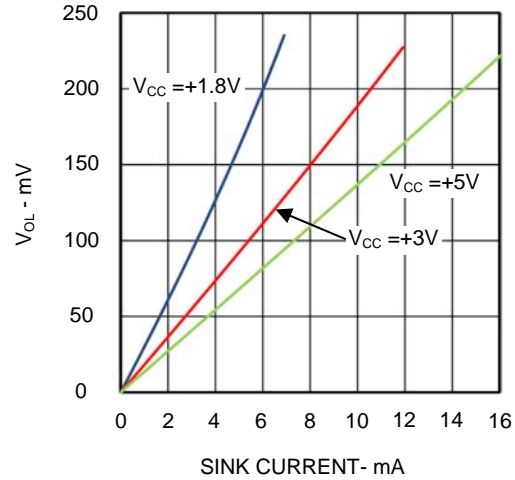

Output Voltage Low vs. Sink Current and Temperature

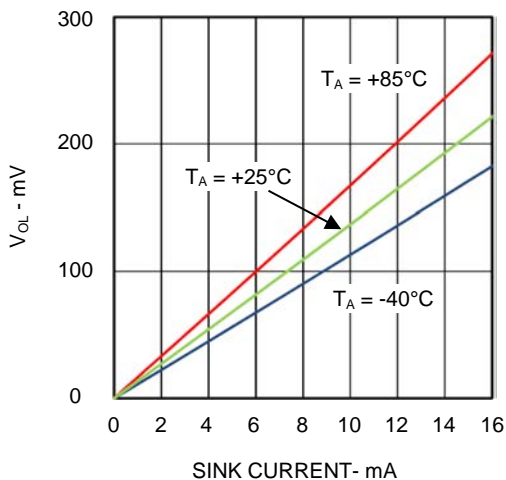

TS9001-1 Output Voltage High vs Source Current

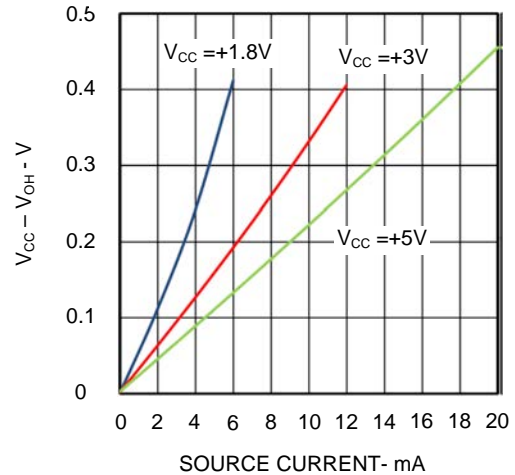



TYPICAL PERFORMANCE CHARACTERISTICS

$V_{CC} = +5V$; $V_{EE} = 0V$; $C_L = 15pF$; $V_{OVERDRIVE} = 100mV$; $T_A = +25^\circ C$, unless otherwise noted.

TS9001-1 Output Voltage High vs Source Current and Temperature

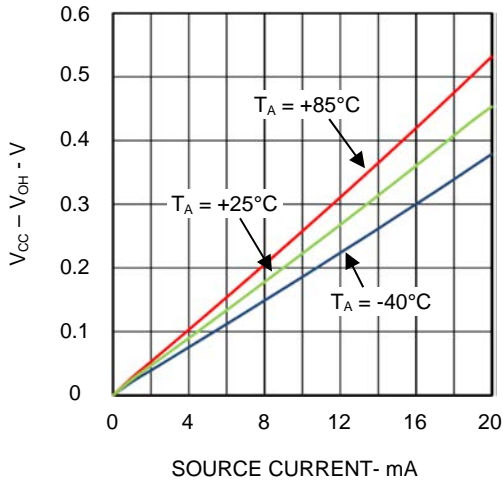

Short-Circuit Sink Current vs Temperature

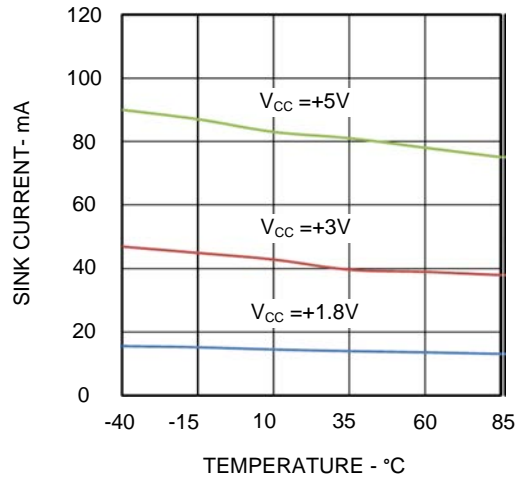

Short-Circuit Source Current vs Temperature

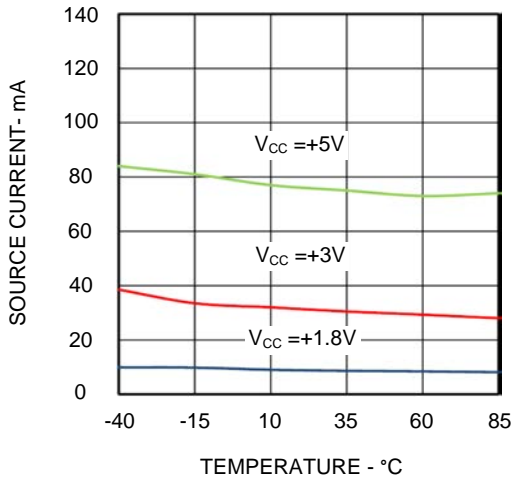

Offset Voltage vs Temperature

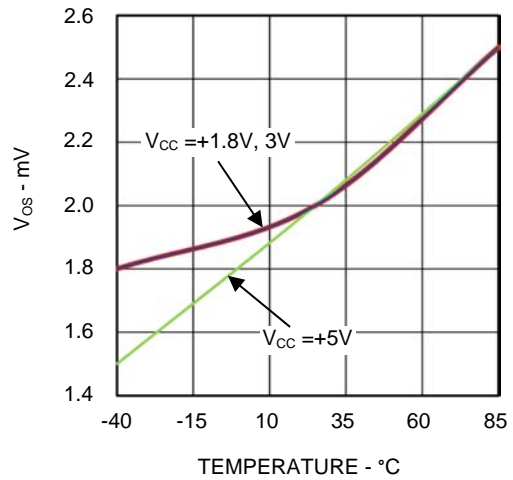

Hysteresis Voltage vs Temperature

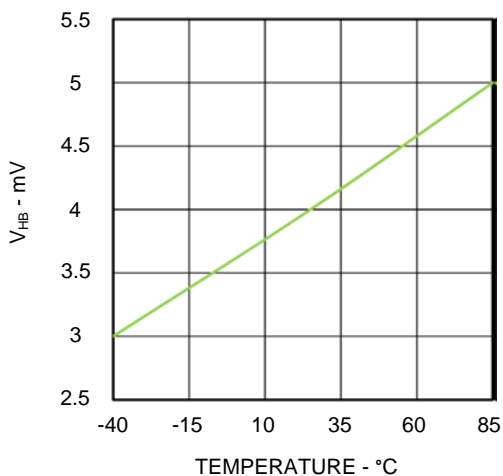

Reference Voltage vs Temperature

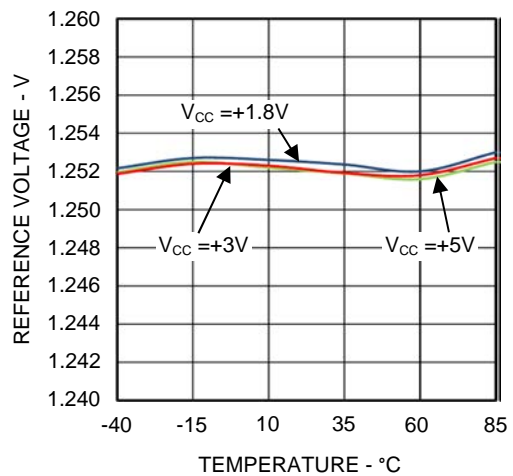

TYPICAL PERFORMANCE CHARACTERISTICS

$V_{CC} = +5V$; $V_{EE} = 0V$; $C_L = 15pF$; $V_{OVERDRIVE} = 100mV$; $T_A = +25^{\circ}C$, unless otherwise noted.

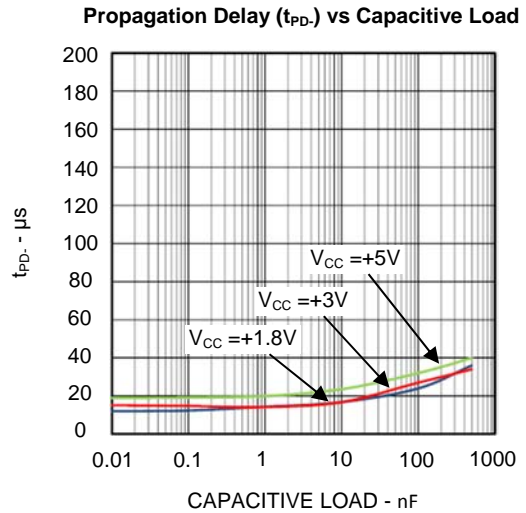
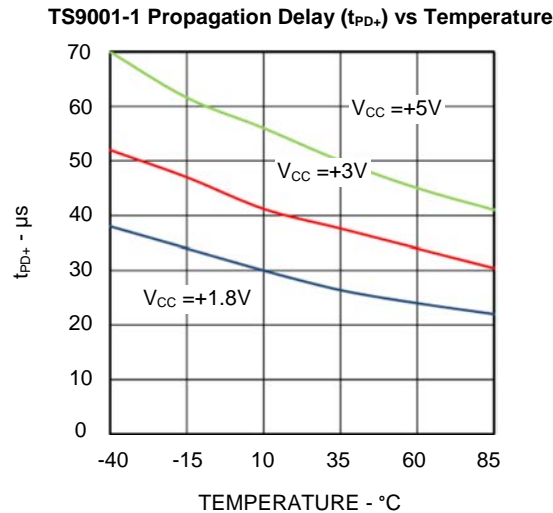
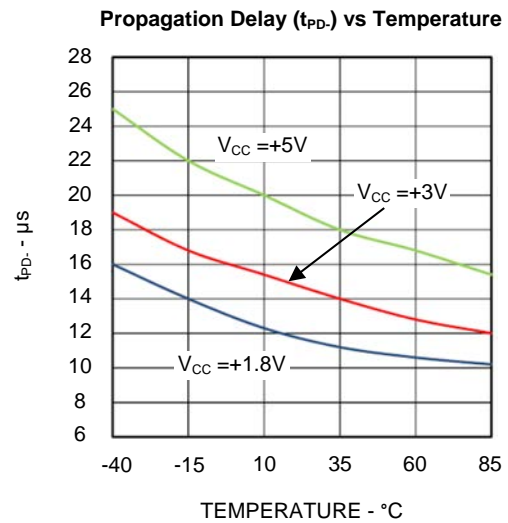
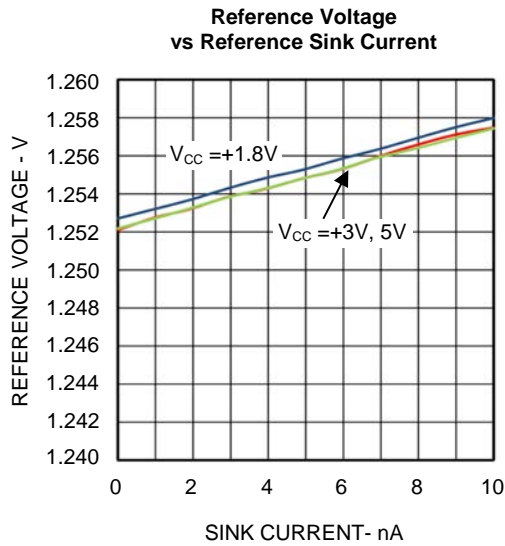
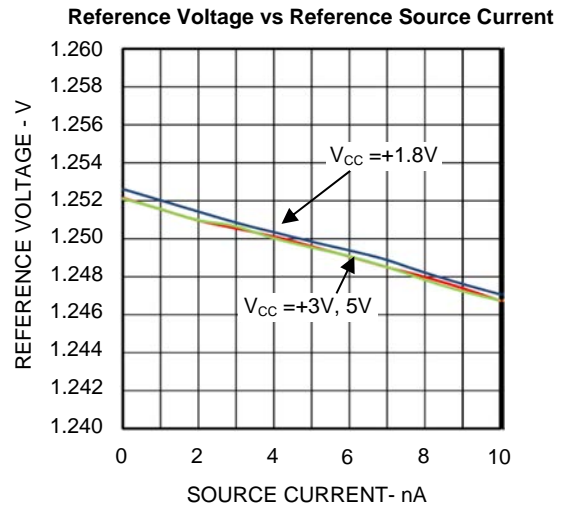
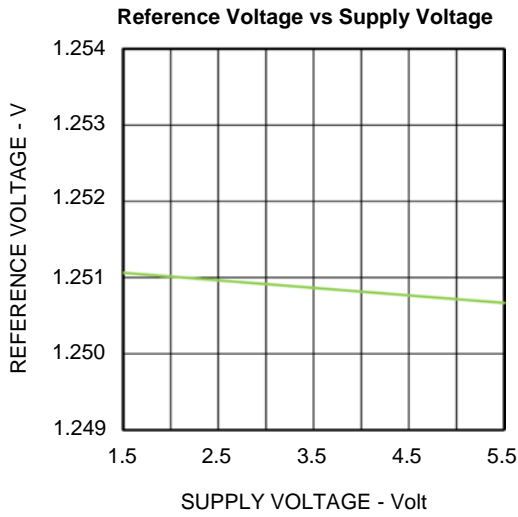



TYPICAL PERFORMANCE CHARACTERISTICS

$V_{CC} = +5V$; $V_{EE} = 0V$; $C_L = 15pF$; $V_{OVERDRIVE} = 100mV$; $T_A = +25^{\circ}C$, unless otherwise noted.

TS9001-1 Propagation Delay (t_{PD+}) vs Capacitive Load

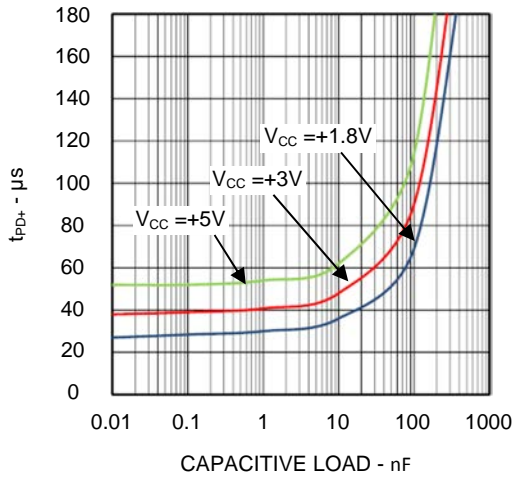

Propagation Delay (t_{PD-}) vs Input Overdrive

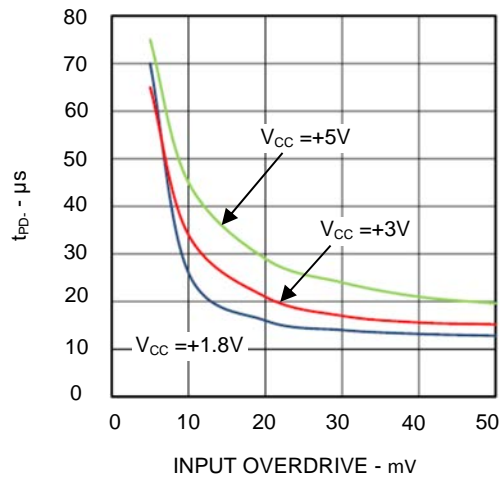

TS9001-1 Propagation Delay (t_{PD+}) vs Input Overdrive

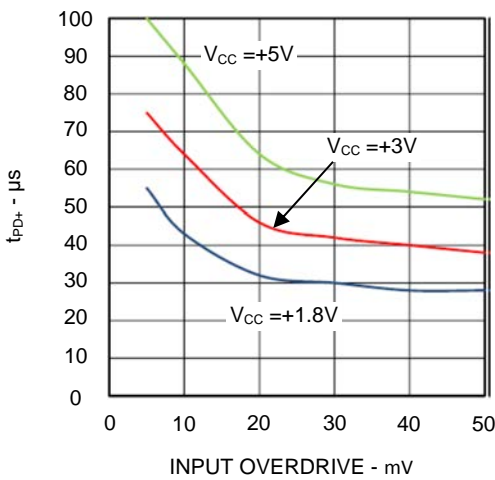

TS9001-2 Propagation Delay (t_{PD-}) vs Pullup Resistance

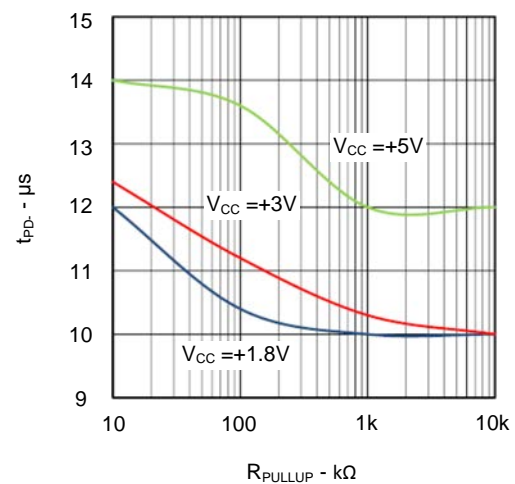

TS9001-2 Propagation Delay (t_{PD+}) vs Pullup Resistance

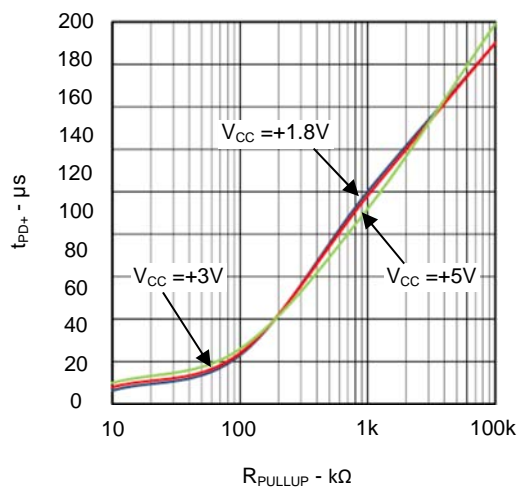

Propagation Delay (t_{PD-}) at $V_{CC} = +5V$

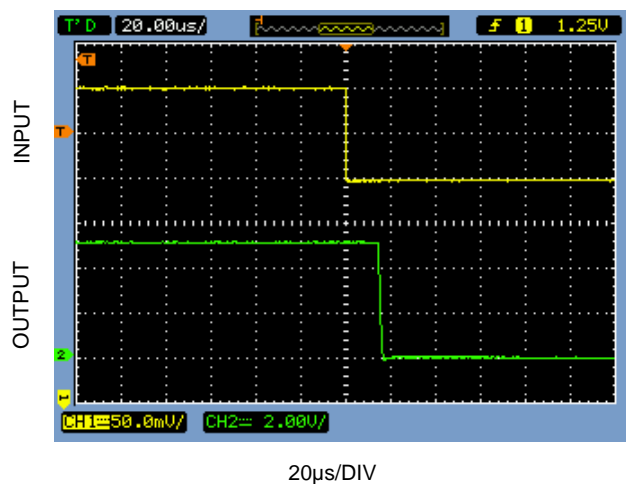

TYPICAL PERFORMANCE CHARACTERISTICS

$V_{CC} = +5V$; $V_{EE} = 0V$; $C_L = 15pF$; $V_{OVERDRIVE} = 100mV$; $T_A = +25^{\circ}C$, unless otherwise noted.

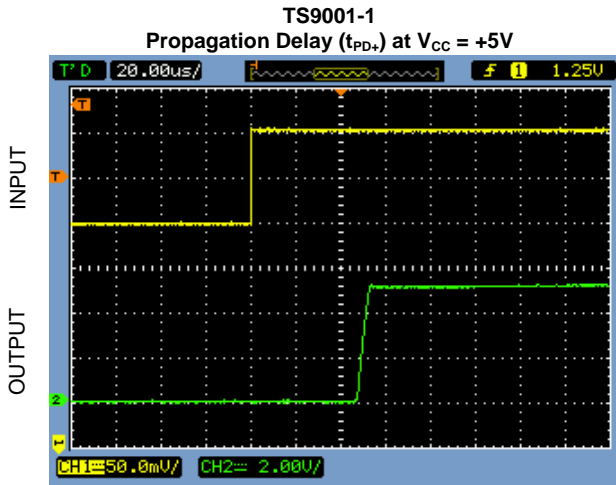

20µs/DIV

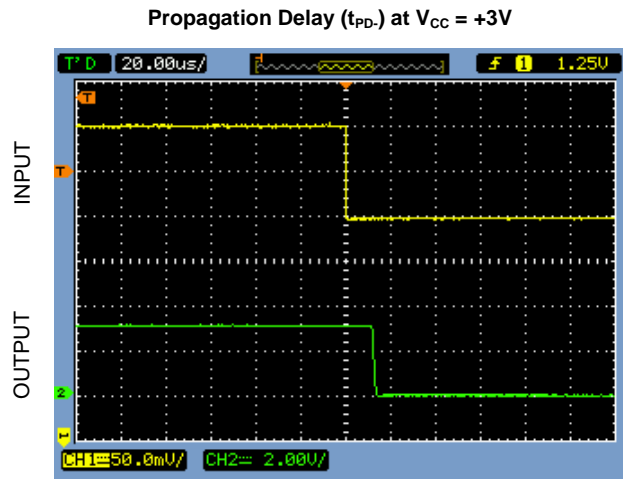

20µs/DIV

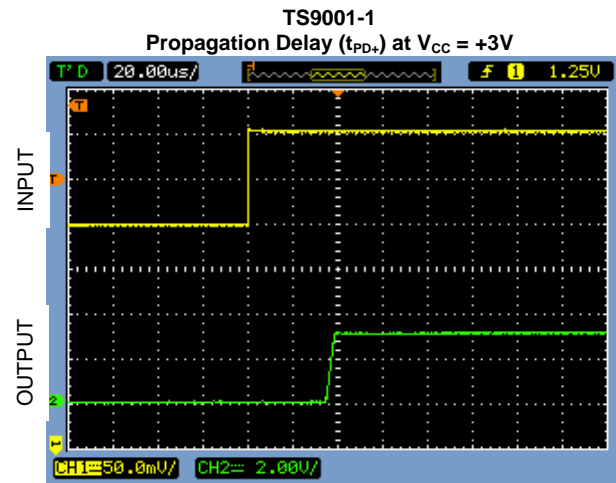

20µs/DIV

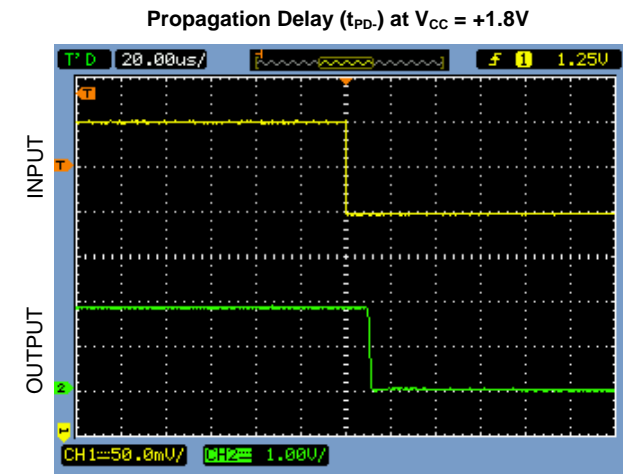

20µs/DIV

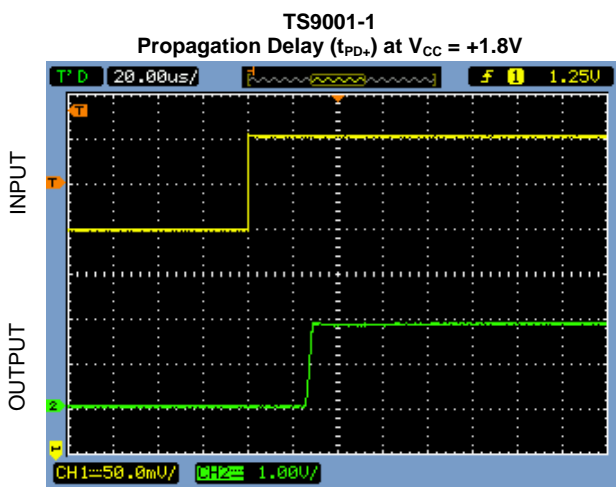

20µs/DIV

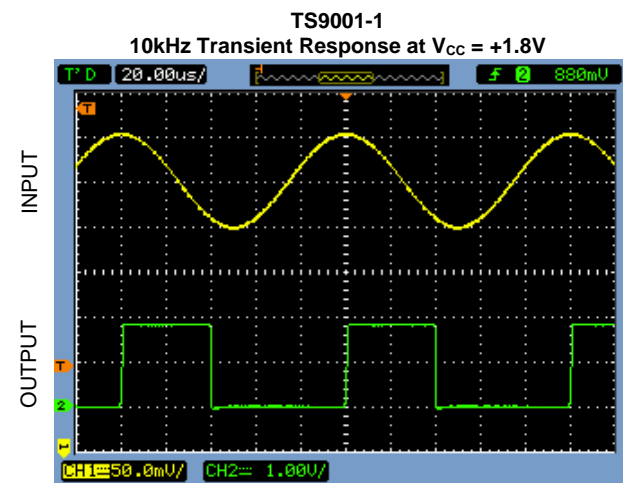

20µs/DIV



TYPICAL PERFORMANCE CHARACTERISTICS

$V_{CC} = +5V$; $V_{EE} = 0V$; $C_L = 15pF$; $V_{OVERDRIVE} = 100mV$; $T_A = +25^{\circ}C$, unless otherwise noted.

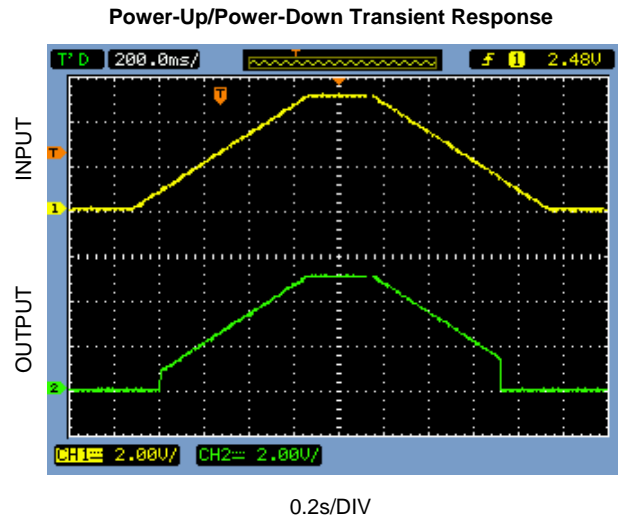
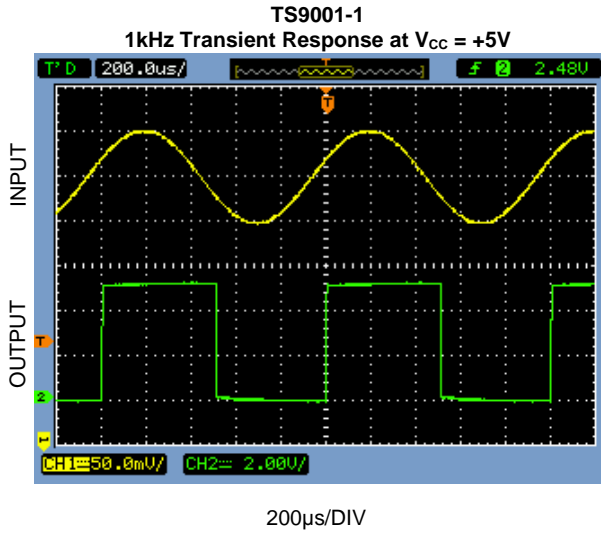

PIN FUNCTIONS

TS9001-1 TS9001-2 SC70-5	NAME	FUNCTION
1	OUT	Comparator Output
2	VEE	Negative Supply Voltage
3	IN+	Comparator Noninverting Input
4	REF/IN-	1.252V Reference Output/Comparator Inverting Input
—	REF	1.252V Reference Output
5	VCC	Positive Supply Voltage
—	IN-	Comparator Inverting Input

BLOCK DIAGRAMS

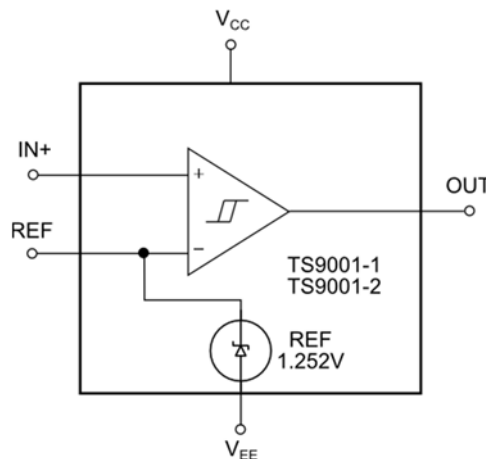

DESCRIPTION OF OPERATION

Guaranteed to operate from +1.6V supplies, the TS9001-1 and the TS9001-2 analog comparators only draw 600nA supply current, feature a robust input stage that can tolerate input voltages 200mV beyond the power supply rails, and include an on-board +1.252V $\pm 1\%$ voltage reference. To insure clean output switching behavior, both analog comparators feature 4mV internal hysteresis. The TS9001-1's push-pull output drivers were designed to minimize supply-current surges while driving $\pm 5\text{mA}$ loads with rail-to-rail output swings. The open-drain output stage TS9001-2 can be connected to supply voltages above V_{CC} to an absolute maximum of 6V above V_{EE} . Where wired-OR logic connections are needed, their open-drain output stages make it easy to use this analog comparator.

Input Stage Circuitry

The robust design of the analog comparators' input stage can accommodate any differential input voltage from $V_{EE} - 0.2\text{V}$ to $V_{CC} + 0.2\text{V}$. Input bias currents are typically $\pm 0.15\text{nA}$ so long as the applied input voltage remains between the supply rails. ESD protection diodes - connected internally to the supply rails - protect comparator inputs against overvoltage conditions. However, if the applied input voltage exceeds either or both supply rails, an increase in input current can occur when these ESD protection diodes start to conduct.

Output Stage Circuitry

Many conventional analog comparators can draw orders of magnitude higher supply current when switching. Because of this behavior, additional power supply bypass capacitance may be required to provide additional charge storage during switching. The design of the TS9001-1's rail-to-rail output stage implements a technique that virtually eliminates supply-current surges when output transitions occur. The supply-current change as a function of output transition frequency exhibited by these analog comparators is very small. Material benefits of this attribute to battery-power applications are the increase in operating time and in reducing the size of power-supply filter capacitors.

Internal Voltage Reference

The TS9001-1/2's internal +1.252V voltage reference exhibits a typical temperature coefficient of 40ppm/°C over the full -40°C to +85°C temperature range. An equivalent circuit for the reference section is illustrated in Figure 1. Since the output impedance of the voltage reference is typically 200kΩ, its output can be bypassed with a low-leakage capacitor and is stable for any capacitive load.

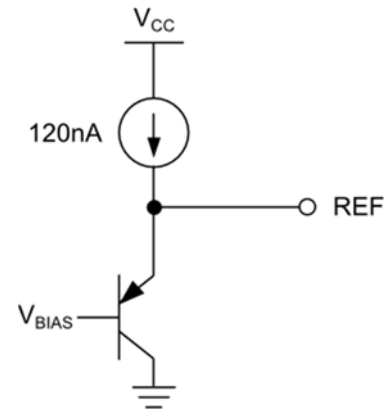

Figure 1: TS9001's Internal V_{REF} Output Equivalent Circuit

An external buffer – such as the TS1001 – can be used to buffer the voltage reference output for higher output current drive or to reduce reference output impedance.

APPLICATIONS INFORMATION

Low-Voltage, Low-Power Operation

Because they were designed specifically for low-power, battery-operated applications, the TS9001-1/2 comparators are an excellent choice. Under nominal conditions, approximate operating times for this analog comparator family is illustrated in Table 1 for a number of battery types and their corresponding charge capacities.

Internal Hysteresis

As a result of circuit noise or unintended parasitic feedback, many analog comparators often break into oscillation within their linear region of operation

especially when the applied differential input voltage approaches 0V (zero volt). Externally-introduced hysteresis is a well-established technique to stabilizing analog comparator behavior and requires external components. As shown in Figure 2, adding comparator hysteresis creates two trip points: V_{THR} (for the rising input voltage) and V_{THF} (for the falling input voltage). The hysteresis band (V_{HB}) is defined as the voltage difference between the two trip points. When a comparator's input voltages are equal, hysteresis effectively forces one comparator input to move quickly past the other input, moving the input

Table 1: Battery Applications using the TS9001

BATTERY TYPE	RECHARGEABLE	V_{FRESH} (V)	$V_{END-OF-LIFE}$ (V)	CAPACITY, AA SIZE (mA-h)	TS9001 OPERATING TIME (hrs)
Alkaline (2 Cells)	No	3.0	1.8	2000	2.5×10^6
Nickel-Cadmium (2 Cells)	Yes	2.4	1.8	750	937,500
Lithium-Ion (1 Cell)	Yes	3.5	2.7	1000	1.25×10^6
Nickel-Metal- Hydride (2 Cells)	Yes	2.4	1.8	1000	1.25×10^6

out of the region where oscillation occurs. Figure 2 illustrates the case in which an IN- input is a fixed voltage and an IN+ is varied. If the input signals were reversed, the figure would be the same with an inverted output. To save cost and external pcb area, an internal 4mV hysteresis circuit was added to the TS9001-1/2.

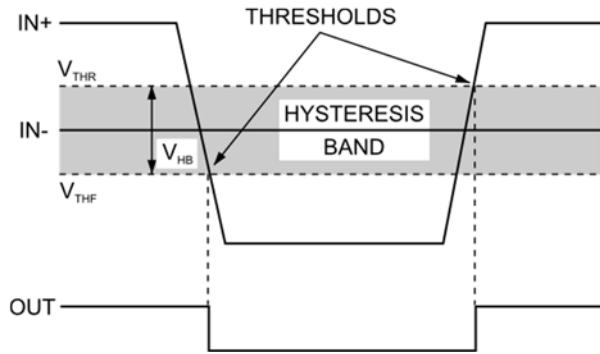

Figure 2: TS9001 Threshold Hysteresis Band

Adding Hysteresis to the TS9001-1 Push-pull Output Option

The TS9001-1 exhibits an internal hysteresis band (V_{HYSB}) of 4mV. Additional hysteresis can be

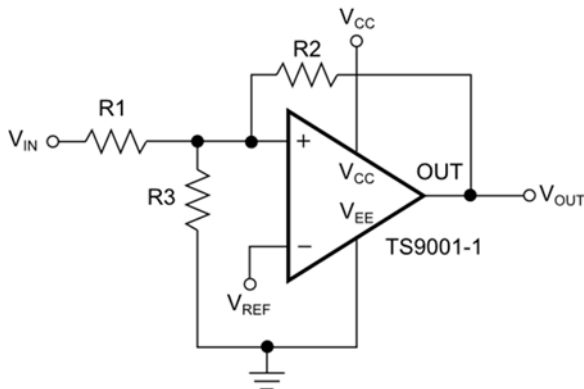

Figure 3: Using Three Resistors Introduces Additional Hysteresis in the TS9001-1.

generated with three external resistors using positive feedback as shown in Figure 3. Unfortunately, this method also reduces the hysteresis response time. The procedure to calculate the resistor values for the TS9001-1 is as follows:

- 1) Setting R2. As the leakage current at the IN pin is less than 2nA, the current through R2 should be at least 0.2µA to minimize offset voltage errors caused by the input leakage current. The current through R2 at the trip

point is $(V_{REF} - V_{OUT})/R2$.

In solving for R2, there are two formulas – one each for the two possible output states:

$$R2 = V_{REF}/I_{R2}$$

or

$$R2 = (V_{CC} - V_{REF})/I_{R2}$$

From the results of the two formulae, the smaller of the two resulting resistor values is chosen. For example, when using the TS9001-1 ($V_{REF} = 1.252V$) at a $V_{CC} = 3.3V$ and if $I_{R2} = 0.2\mu A$ is chosen, then the formulae above produce two resistor values: 6.26MΩ and 10.24MΩ - the 6.2MΩ standard value for R2 is selected.

- 2) Next, the desired hysteresis band (V_{HYSB}) is set. In this example, V_{HYSB} is set to 100mV.
- 3) Resistor R1 is calculated according to the following equation:

$$R1 = R2 \times (V_{HYSB}/V_{CC})$$

and substituting the values selected in 1) and 2) above yields:

$$R1 = 6.2M\Omega \times (100mV/3.3V) = 187.88k\Omega.$$

The 187kΩ standard value for R1 is chosen.

- 4) The trip point for V_{IN} rising (V_{THR}) is chosen such that $V_{THR} > V_{REF} \times (R1 + R2)/R2$ (V_{THF} is the trip point for V_{IN} falling). This is the threshold voltage at which the comparator switches its output from low to high as V_{IN} rises above the trip point. In this example, V_{THR} is set to 3V.
- 5) With the V_{THR} from Step 4 above, resistor R3 is then computed as follows:

$$R3 = 1/[V_{THR}/(V_{REF} \times R1) - (1/R1) - (1/R2)]$$

$$R3 = 1/[3V/(1.252V \times 187k\Omega) - (1/187k\Omega) - (1/6.2M\Omega)] = 136.9k\Omega$$

In this example, a 137kΩ, 1% standard value resistor is selected for R3..

- The last step is to verify the trip voltages and hysteresis band using the standard resistance values:

For V_{IN} rising:

$$V_{THR} = V_{REF} \times R1 \left[\frac{1}{R1} + \frac{1}{R2} + \frac{1}{R3} \right] = 3V$$

For V_{IN} falling:

$$V_{THF} = V_{THR} - (R1 \times V_{CC}/R2) = 2.9V$$

and Hysteresis Band = $V_{THR} - V_{THF} = 100mV$

Adding Hysteresis to the TS9001-2 Open-Drain Option

The TS9001-2 has open-drain output and requires an external pull-up resistor to V_{CC} as shown in Figure 4. Additional hysteresis can be generated

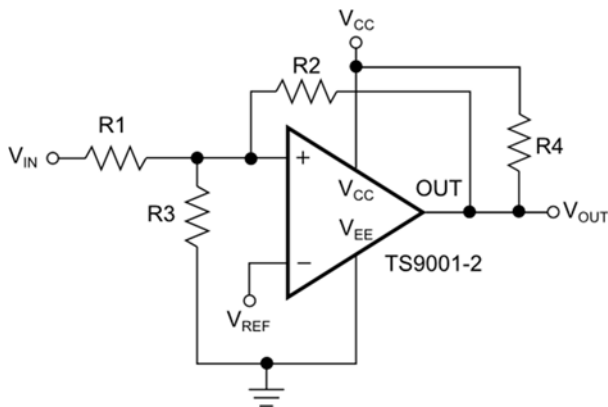

Figure 4: Using Four Resistors Introduces Additional Hysteresis in the TS9001-2.

using positive feedback; however, the formulae differ slightly from those of the push-pull option TS9001-1. The procedure to calculate the resistor values for the TS9001-2 is as follows:

- As in the previous section, resistor R2 is chosen according to the formulae:

$$R2 = V_{REF}/0.2\mu A$$

or

$$R2 = (V_{CC} - V_{REF})/0.2\mu A - R4$$

where the smaller of the two resulting resistor values is the best starting value.

- As before, the desired hysteresis band (V_{HYSB}) is set to 100mV.

- Next, resistor R1 is then computed according to the following equation:

$$R1 = (R2 + R4) \times (V_{HYSB}/V_{CC})$$

- The trip point for V_{IN} rising (V_{THR}) is chosen (again, remember that V_{THF} is the trip point for V_{IN} falling). This is the threshold voltage at which the comparator switches its output from low to high as V_{IN} rises above the trip point.

- With the V_{THR} from Step 4 above, resistor R3 is computed as follows:

$$R3 = 1/[V_{THR}/(V_{REF} \times R1) - (1/R1) - (1/R2)]$$

- As before, the last step is to verify the trip voltages and hysteresis band with the standard resistor values used in the circuit:

For V_{IN} rising:

$$V_{THR} = V_{REF} \times R1 \times (1/R1 + 1/R2 + 1/R3)$$

For V_{IN} falling:

$$V_{THF} = V_{REF} \times R1 \times (1/R1 + 1/R3 + 1/(R2 + R4)) - (R1/(R2 + R4)) \times V_{CC}$$

and Hysteresis Band is given by $V_{THR} - V_{THF}$

PC Board Layout and Power-Supply Bypassing

While power-supply bypass capacitors are not typically required, it is good engineering practice to use 0.1uF bypass capacitors close to the device's power supply pins when the power supply impedance is high, the power supply leads are long, or there is excessive noise on the power supply traces. To reduce stray capacitance, it is also good engineering practice to make signal trace lengths as short as possible. Also recommended are a ground plane and surface mount resistors and capacitors.

PACKAGE OUTLINE DRAWING

5-Pin SC70 Package Outline Drawing

(N.B., Drawings are not to scale)

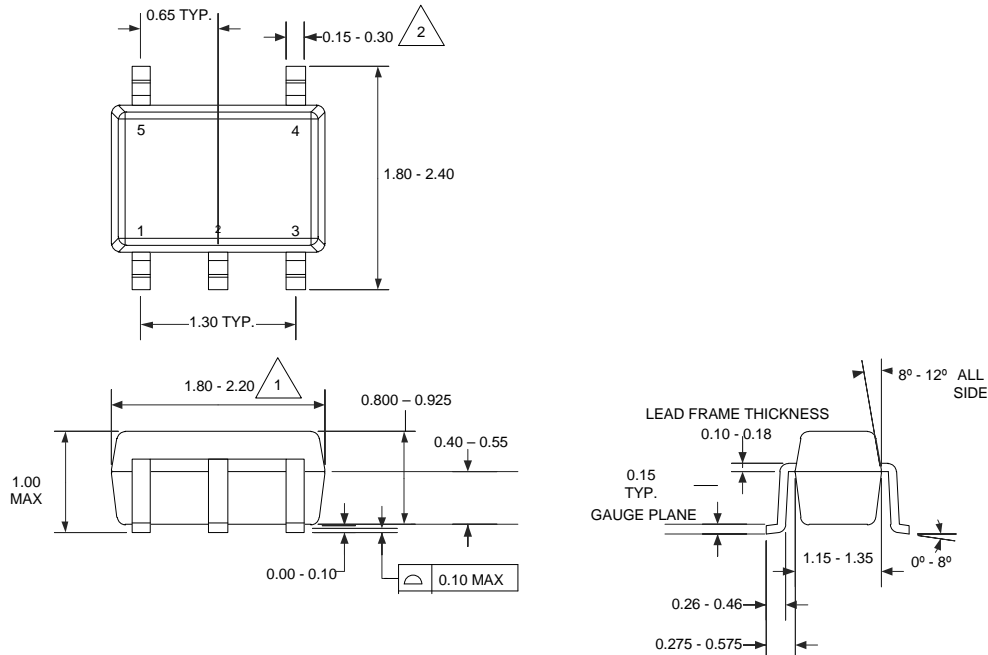

NOTES:

- 1. DOES NOT INCLUDE MOLD FLASH, PROTRUSIONS OR GATE BURRS.
- 2. DOES NOT INCLUDE INTER-LEAD FLASH OR PROTRUSIONS.
- 3. DIE IS FACING UP FOR MOLDING. DIE IS FACING DOWN FOR TRIM/FORM.
- 4. ALL SPECIFICATION COMPLY TO JEDEC SPEC MO-203 AA
- 5. CONTROLLING DIMENSIONS IN MILLIMETERS.
- 6. ALL SPECIFICATIONS REFER TO JEDEC MO-203 AA
- 7. LEAD SPAN/STAND OFF HEIGHT/COPLANARITY ARE CONSIDERED AS SPECIAL CHARACTERISTIC

Patent Notice

Silicon Labs invests in research and development to help our customers differentiate in the market with innovative low-power, small size, analog-intensive mixed-signal solutions. Silicon Labs' extensive patent portfolio is a testament to our unique approach and world-class engineering team.

The information in this document is believed to be accurate in all respects at the time of publication but is subject to change without notice. Silicon Laboratories assumes no responsibility for errors and omissions, and disclaims responsibility for any consequences resulting from the use of information included herein. Additionally, Silicon Laboratories assumes no responsibility for the functioning of undescribed features or parameters. Silicon Laboratories reserves the right to make changes without further notice. Silicon Laboratories makes no warranty, representation or guarantee regarding the suitability of its products for any particular purpose, nor does Silicon Laboratories assume any liability arising out of the application or use of any product or circuit, and specifically disclaims any and all liability, including without limitation consequential or incidental damages. Silicon Laboratories products are not designed, intended, or authorized for use in applications intended to support or sustain life, or for any other application in which the failure of the Silicon Laboratories product could create a situation where personal injury or death may occur. Should Buyer purchase or use Silicon Laboratories products for any such unintended or unauthorized application, Buyer shall indemnify and hold Silicon Laboratories harmless against all claims and damages.

Silicon Laboratories and Silicon Labs are trademarks of Silicon Laboratories Inc.
Other products or brandnames mentioned herein are trademarks or registered trademarks of their respective holders.

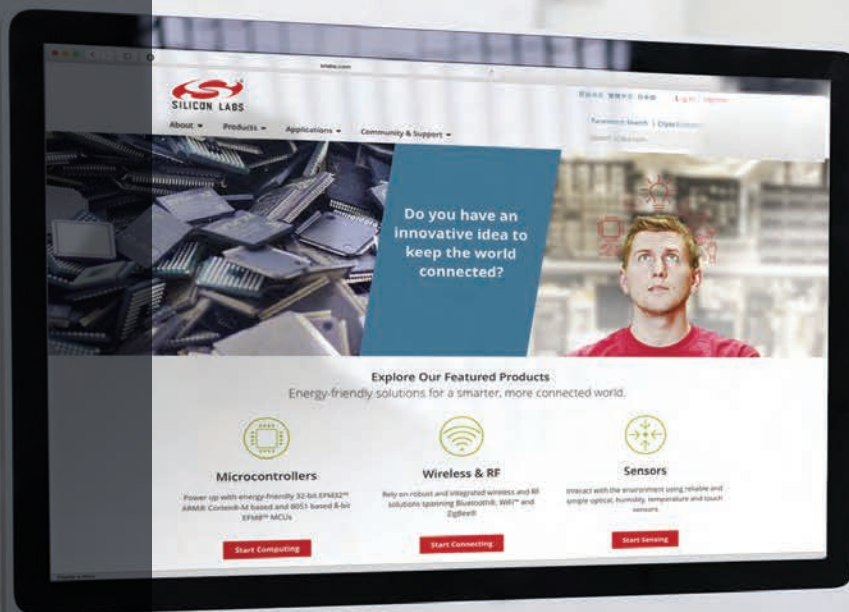

Smart.
Connected.
Energy-Friendly



Products
www.silabs.com/products



Quality
www.silabs.com/quality



Support and Community
community.silabs.com

Disclaimer

Silicon Laboratories intends to provide customers with the latest, accurate, and in-depth documentation of all peripherals and modules available for system and software implementers using or intending to use the Silicon Laboratories products. Characterization data, available modules and peripherals, memory sizes and memory addresses refer to each specific device, and "Typical" parameters provided can and do vary in different applications. Application examples described herein are for illustrative purposes only. Silicon Laboratories reserves the right to make changes without further notice and limitation to product information, specifications, and descriptions herein, and does not give warranties as to the accuracy or completeness of the included information. Silicon Laboratories shall have no liability for the consequences of use of the information supplied herein. This document does not imply or express copyright licenses granted hereunder to design or fabricate any integrated circuits. The products must not be used within any Life Support System without the specific written consent of Silicon Laboratories. A "Life Support System" is any product or system intended to support or sustain life and/or health, which, if it fails, can be reasonably expected to result in significant personal injury or death. Silicon Laboratories products are generally not intended for military applications. Silicon Laboratories products shall under no circumstances be used in weapons of mass destruction including (but not limited to) nuclear, biological or chemical weapons, or missiles capable of delivering such weapons.

Trademark Information

Silicon Laboratories Inc., Silicon Laboratories, Silicon Labs, SiLabs and the Silicon Labs logo, CMEMS®, EFM, EFM32, EFR, Energy Micro, Energy Micro logo and combinations thereof, "the world's most energy friendly microcontrollers", Ember®, EZLink®, EZMac®, EZRadio®, EZRadioPRO®, DSPLL®, ISOmodem®, Precision32®, ProSLIC®, SiPHY®, USBXpress® and others are trademarks or registered trademarks of Silicon Laboratories Inc. ARM, CORTEX, Cortex-M3 and THUMB are trademarks or registered trademarks of ARM Holdings. Keil is a registered trademark of ARM Limited. All other products or brand names mentioned herein are trademarks of their respective holders.



Silicon Laboratories Inc.
400 West Cesar Chavez
Austin, TX 78701
USA

<http://www.silabs.com>