



Is Now Part of



ON Semiconductor®

To learn more about ON Semiconductor, please visit our website at
www.onsemi.com

ON Semiconductor and the ON Semiconductor logo are trademarks of Semiconductor Components Industries, LLC dba ON Semiconductor or its subsidiaries in the United States and/or other countries. ON Semiconductor owns the rights to a number of patents, trademarks, copyrights, trade secrets, and other intellectual property. A listing of ON Semiconductor's product/patent coverage may be accessed at www.onsemi.com/site/pdf/Patent-Marking.pdf. ON Semiconductor reserves the right to make changes without further notice to any products herein. ON Semiconductor makes no warranty, representation or guarantee regarding the suitability of its products for any particular purpose, nor does ON Semiconductor assume any liability arising out of the application or use of any product or circuit, and specifically disclaims any and all liability, including without limitation special, consequential or incidental damages. Buyer is responsible for its products and applications using ON Semiconductor products, including compliance with all laws, regulations and safety requirements or standards, regardless of any support or applications information provided by ON Semiconductor. "Typical" parameters which may be provided in ON Semiconductor data sheets and/or specifications can and do vary in different applications and actual performance may vary over time. All operating parameters, including "Typicals" must be validated for each customer application by customer's technical experts. ON Semiconductor does not convey any license under its patent rights nor the rights of others. ON Semiconductor products are not designed, intended, or authorized for use as a critical component in life support systems or any FDA Class 3 medical devices or medical devices with a same or similar classification in a foreign jurisdiction or any devices intended for implantation in the human body. Should Buyer purchase or use ON Semiconductor products for any such unintended or unauthorized application, Buyer shall indemnify and hold ON Semiconductor and its officers, employees, subsidiaries, affiliates, and distributors harmless against all claims, costs, damages, and expenses, and reasonable attorney fees arising out of, directly or indirectly, any claim of personal injury or death associated with such unintended or unauthorized use, even if such claim alleges that ON Semiconductor was negligent regarding the design or manufacture of the part. ON Semiconductor is an Equal Opportunity/Affirmative Action Employer. This literature is subject to all applicable copyright laws and is not for resale in any manner.



December 2014

4N38M, H11D1M, H11D3M, MOC8204M 6-Pin DIP High Voltage Phototransistor Optocouplers

Features

- High Voltage:
 - MOC8204M, $BV_{CEO} = 400\text{ V}$
 - H11D1M, $BV_{CEO} = 300\text{ V}$
 - H11D3M, $BV_{CEO} = 200\text{ V}$
- Safety and Regulatory Approvals:
 - UL1577, 4,170 VAC_{RMS} for 1 Minute
- DIN-EN/IEC60747-5-5, 850 V Peak Working Insulation Voltage

Applications

- Power Supply Regulators
- Digital Logic Inputs
- Microprocessor Inputs
- Appliance Sensor Systems
- Industrial Controls

Description

The 4N38M, H11D1M, H11D3M, and MOC8204M are phototransistor-type optically coupled optoisolators. A gallium arsenide infrared emitting diode is coupled with a high voltage NPN silicon phototransistor. The device is supplied in a standard plastic six-pin dual-in-line package.

Schematic



Figure 1. Schematic

Package Outlines

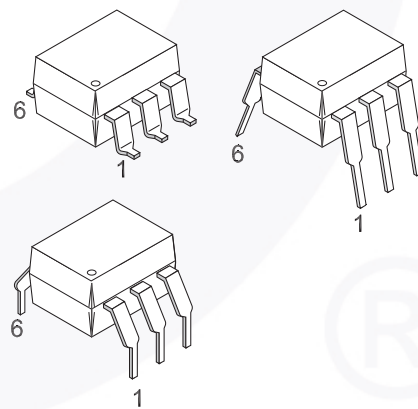

Figure 2. Package Outlines

4N38M, H11D1M, H11D3M, MOC8204M — 6-Pin DIP High Voltage Phototransistor Optocouplers

Safety and Insulation Ratings

As per DIN EN/IEC 60747-5-5, this optocoupler is suitable for “safe electrical insulation” only within the safety limit data. Compliance with the safety ratings shall be ensured by means of protective circuits.

Parameter		Characteristics
Installation Classifications per DIN VDE 0110/1.89 Table 1, For Rated Mains Voltage	< 150 V _{RMS}	I–IV
	< 300 V _{RMS}	I–IV
Climatic Classification		55/100/21
Pollution Degree (DIN VDE 0110/1.89)		2
Comparative Tracking Index		175

Symbol	Parameter	Value	Unit
V _{PR}	Input-to-Output Test Voltage, Method A, V _{IORM} × 1.6 = V _{PR} , Type and Sample Test with t _m = 10 s, Partial Discharge < 5 pC	1360	V _{peak}
	Input-to-Output Test Voltage, Method B, V _{IORM} × 1.875 = V _{PR} , 100% Production Test with t _m = 1 s, Partial Discharge < 5 pC	1594	V _{peak}
V _{IORM}	Maximum Working Insulation Voltage	850	V _{peak}
V _{IOTM}	Highest Allowable Over-Voltage	6000	V _{peak}
	External Creepage	≥ 7	mm
	External Clearance	≥ 7	mm
	External Clearance (for Option TV, 0.4" Lead Spacing)	≥ 10	mm
DTI	Distance Through Insulation (Insulation Thickness)	≥ 0.5	mm
T _S	Case Temperature ⁽¹⁾	175	°C
I _{S,INPUT}	Input Current ⁽¹⁾	350	mA
P _{S,OUTPUT}	Output Power ⁽¹⁾	800	mW
R _{IO}	Insulation Resistance at T _S , V _{IO} = 500 V ⁽¹⁾	> 10 ⁹	Ω

Note:

1. Safety limit values – maximum values allowed in the event of a failure.

Absolute Maximum Ratings

Stresses exceeding the absolute maximum ratings may damage the device. The device may not function or be operable above the recommended operating conditions and stressing the parts to these levels is not recommended. In addition, extended exposure to stresses above the recommended operating conditions may affect device reliability. The absolute maximum ratings are stress ratings only.

Symbol	Parameter	Device	Value	Unit
TOTAL DEVICE				
T _{STG}	Storage Temperature	All	-40 to +125	°C
T _{OPR}	Operating Temperature	All	-40 to +100	°C
T _J	Junction Temperature	All	-40 to +125	°C
T _{SOL}	Lead Solder Temperature	All	260 for 10 seconds	°C
P _D	Total Device Power Dissipation @ T _A = 25°C	All	420	mW
	Derate Above 25°C		3.5	mW/°C
EMITTER				
I _F	Forward DC Current ⁽²⁾	All	80	mA
V _R	Reverse Input Voltage ⁽²⁾	All	6.0	V
I _{F(pk)}	Forward Current – Peak (1 μs pulse, 300pps) ⁽²⁾	All	3.0	A
P _D	LED Power Dissipation @ T _A = 25°C ⁽²⁾	All	120	mW
	Derate Above 25°C		1.41	mW/°C
DETECTOR				
P _D	Power Dissipation @ T _A = 25°C	All	300	mW
	Derate linearly above 25°C		4.0	mW/°C
V _{CEO}	Collector to Emitter Voltage ⁽²⁾	MOC8204M	400	V
		H11D1M	300	V
		H11D3M	200	V
		4N38M	80	V
V _{CB0}	Collector Base Voltage ⁽²⁾	MOC8204M	400	V
		H11D1M	300	V
		H11D3M	200	V
		4N38M	80	V
V _{ECO}	Emitter to Collector Voltage ⁽²⁾	H11D1M, H11D3M, MOC8204M	7	V
I _C	Collector Current (Continuous)	All	100	mA

Note:

2. Parameters meet or exceed JEDEC registered data (for 4N38M only).

Electrical Characteristics

$T_A = 25^\circ\text{C}$ unless otherwise specified.

Individual Component Characteristics

Symbol	Characteristic	Test Conditions	Device	Min.	Typ.	Max.	Unit
EMITTER							
V_F	Forward Voltage ⁽³⁾	$I_F = 10\text{ mA}$	All		1.15	1.50	V
$\frac{\Delta V_F}{\Delta T_A}$	Forward Voltage Temperature Coefficient		All		-1.8		mV/°C
BV_R	Reverse Breakdown Voltage	$I_R = 10\text{ }\mu\text{A}$	All	6	25		V
C_J	Junction Capacitance	$V_F = 0\text{ V}, f = 1\text{ MHz}$	All		50		pF
		$V_F = 1\text{ V}, f = 1\text{ MHz}$			65		pF
I_R	Reverse Leakage Current ⁽³⁾	$V_R = 6\text{ V}$	All		0.05	10	μA
DETECTOR							
BV_{CEO}	Breakdown Voltage Collector-to-Emitter ⁽³⁾	$R_{BE} = 1\text{ M}\Omega,$ $I_C = 1.0\text{ mA}, I_F = 0$	MOC8204M	400			V
			H11D1M	300			V
			H11D3M	200			V
			No RBE, $I_C = 1.0\text{ mA}$	4N38M	80		
BV_{CBO}	Collector to Base ⁽³⁾	$I_C = 100\text{ }\mu\text{A}, I_F = 0$	MOC8204M	400			V
			H11D1M	300			V
			H11D3M	200			V
			4N38M	80			V
BV_{EBO}	Emitter to Base	$I_E = 100\text{ }\mu\text{A}, I_F = 0$	4N38M	7			V
BV_{ECO}	Emitter to Collector	$I_E = 100\text{ }\mu\text{A}, I_F = 0$	All	7	10		V
I_{CEO}	Leakage Current Collector to Emitter ⁽³⁾ ($R_{BE} = 1\text{ M}\Omega$)	$V_{CE} = 300\text{ V}, I_F = 0,$ $T_A = 25^\circ\text{C}$	MOC8204M			100	nA
		$V_{CE} = 300\text{ V}, I_F = 0,$ $T_A = 100^\circ\text{C}$				250	μA
		$V_{CE} = 200\text{ V}, I_F = 0,$ $T_A = 25^\circ\text{C}$	H11D1M			100	nA
		$V_{CE} = 200\text{ V}, I_F = 0,$ $T_A = 100^\circ\text{C}$				250	μA
		$V_{CE} = 100\text{ V}, I_F = 0,$ $T_A = 25^\circ\text{C}$	H11D3M			100	nA
		$V_{CE} = 100\text{ V}, I_F = 0,$ $T_A = 100^\circ\text{C}$				250	μA
			No $R_{BE}, V_{CE} = 60\text{ V},$ $I_F = 0, T_A = 25^\circ\text{C}$	4N38M			50

Note:

3. Parameters meet or exceed JEDEC registered data (for 4N38M only).

Electrical Characteristics (Continued) $T_A = 25^\circ\text{C}$ unless otherwise specified.**Transfer Characteristics**

Symbol	Characteristics	Test Conditions	Device	Min.	Typ.	Max.	Unit
EMITTER							
CTR	Current Transfer Ratio, Collector-to-Emitter	$I_F = 10\text{ mA}, V_{CE} = 10\text{ V}, R_{BE} = 1\text{ M}\Omega$	H11D1M, H11D3M, MOC8204M	2 (20)			mA (%)
		$I_F = 10\text{ mA}, V_{CE} = 10\text{ V}$	4N38M	2 (20)			mA (%)
$V_{CE(SAT)}$	Saturation Voltage ⁽⁴⁾	$I_F = 10\text{ mA}, I_C = 0.5\text{ mA}, R_{BE} = 1\text{ M}\Omega$	H11D1M, H11D3M, MOC8204M		0.1	0.4	V
		$I_F = 20\text{ mA}, I_C = 4\text{ mA}$	4N38M			1.0	V
SWITCHING TIMES							
t_{ON}	Non-Saturated Turn-on Time	$V_{CE} = 10\text{ V}, I_C = 2\text{ mA}, R_L = 100\ \Omega$	All		5		μs
t_{OFF}	Turn-off Time		All		5		μs

Note:

4. Parameters meet or exceed JEDEC registered data (for 4N38M only).

Isolation Characteristics

Symbol	Characteristic	Test Conditions	Min.	Typ.	Max.	Unit
V_{ISO}	Input-Output Isolation Voltage	$t = 1\text{ Minute}$	4170			$V_{AC(RMS)}$
C_{ISO}	Isolation Capacitance	$V_{I-O} = 0\text{ V}, f = 1\text{ MHz}$		0.2		pF
R_{ISO}	Isolation Resistance	$V_{I-O} = \pm 500\text{ VDC}, T_A = 25^\circ\text{C}$	10^{11}			Ω

Typical Performance Curves

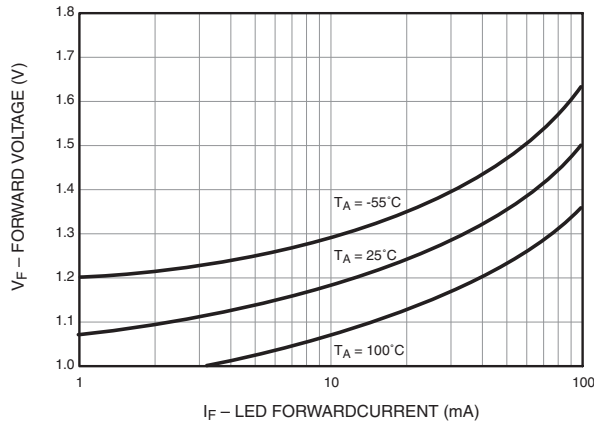

Figure 3. LED Forward Voltage vs. Forward Current

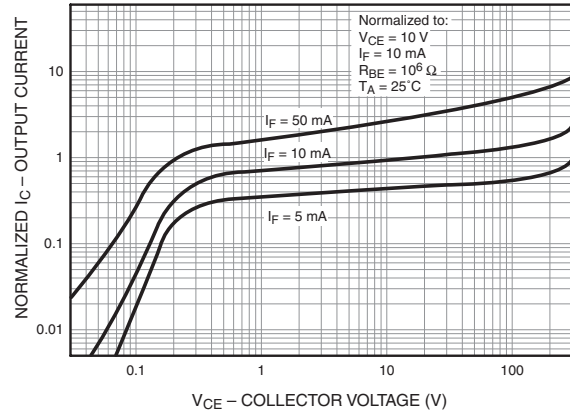

Figure 4. Normalized Output Characteristics

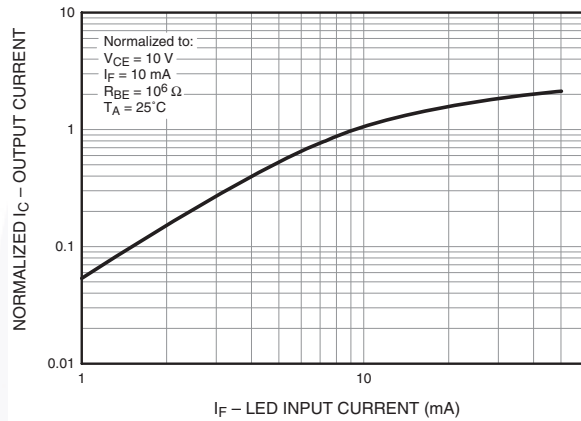

Figure 5. Normalized Output Current vs. LED Input Current

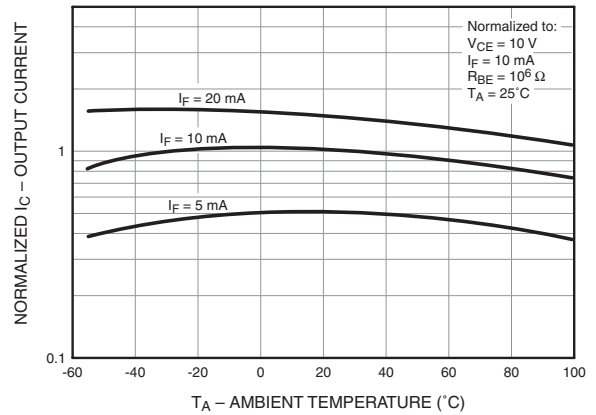

Figure 6. Normalized Output Current vs. Temperature

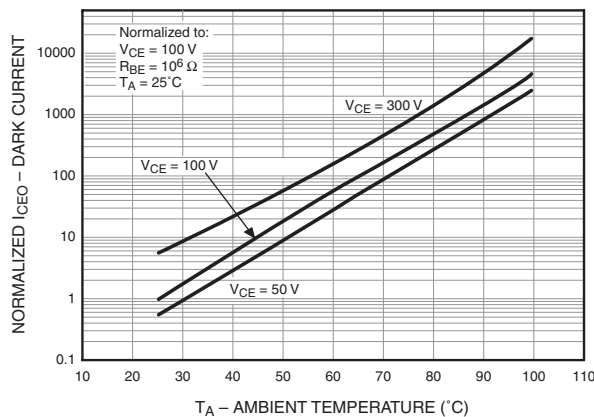

Figure 7. Normalized Dark Current vs. Ambient Temperature

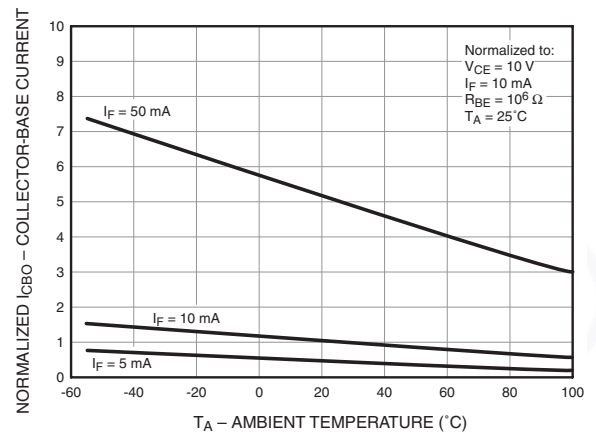

Figure 8. Normalized Collector-Base Current vs. Temperature

Reflow Profile



Figure 9. Reflow Profile

Ordering Information

Part Number	Package	Packing Method
H11D1M	DIP 6-Pin	Tube (50 Units)
H11D1SM	SMT 6-Pin (Lead Bend)	Tube (50 Units)
H11D1SR2M	SMT 6-Pin (Lead Bend)	Tape and Reel (1000 Units)
H11D1VM	DIP 6-Pin, DIN EN/IEC60747-5-5 Option	Tube (50 Units)
H11D1SVM	SMT 6-Pin (Lead Bend), DIN EN/IEC60747-5-5 Option	Tube (50 Units)
H11D1SR2VM	SMT 6-Pin (Lead Bend), DIN EN/IEC60747-5-5 Option	Tape and Reel (1000 Units)
H11D1TVM	DIP 6-Pin, 0.4" Lead Spacing, DIN EN/IEC60747-5-5 Option	Tube (50 Units)

Note:

2. The product orderable part number system listed in this table also applies to the 4N38M, H11D3M, and MOC8204M devices.

Marking Information



Figure 10. 12. Top Mark

Table 1. Top Mark Definitions

1	Fairchild Logo
2	Device Number
3	DIN EN/IEC60747-5-5 Option (only appears on component ordered with this option)
4	One-Digit Year Code, e.g., "4"
5	Digit Work Week, Ranging from "01" to "53"
6	Assembly Package Code



NOTES:

- A) NO STANDARD APPLIES TO THIS PACKAGE.
- B) ALL DIMENSIONS ARE IN MILLIMETERS.
- C) DIMENSIONS ARE EXCLUSIVE OF BURRS, MOLD FLASH, AND TIE BAR EXTRUSION
- D) DRAWING FILENAME AND REVISION: MKT-N06BREV4.





LAND PATTERN RECOMMENDATION



NOTES:

- A) NO STANDARD APPLIES TO THIS PACKAGE.
- B) ALL DIMENSIONS ARE IN MILLIMETERS.
- C) DIMENSIONS ARE EXCLUSIVE OF BURRS, MOLD FLASH, AND TIE BAR EXTRUSION
- D) DRAWING FILENAME AND REVISION : MKT-N06CREV4.





NOTES:

- A) NO STANDARD APPLIES TO THIS PACKAGE.
- B) ALL DIMENSIONS ARE IN MILLIMETERS.
- C) DIMENSIONS ARE EXCLUSIVE OF BURRS, MOLD FLASH, AND TIE BAR EXTRUSION
- D) DRAWING FILENAME AND REVISION: MKT-N06Drev4



ON Semiconductor and  are trademarks of Semiconductor Components Industries, LLC dba ON Semiconductor or its subsidiaries in the United States and/or other countries. ON Semiconductor owns the rights to a number of patents, trademarks, copyrights, trade secrets, and other intellectual property. A listing of ON Semiconductor's product/patent coverage may be accessed at www.onsemi.com/site/pdf/Patent-Marking.pdf. ON Semiconductor reserves the right to make changes without further notice to any products herein. ON Semiconductor makes no warranty, representation or guarantee regarding the suitability of its products for any particular purpose, nor does ON Semiconductor assume any liability arising out of the application or use of any product or circuit, and specifically disclaims any and all liability, including without limitation special, consequential or incidental damages. Buyer is responsible for its products and applications using ON Semiconductor products, including compliance with all laws, regulations and safety requirements or standards, regardless of any support or applications information provided by ON Semiconductor. "Typical" parameters which may be provided in ON Semiconductor data sheets and/or specifications can and do vary in different applications and actual performance may vary over time. All operating parameters, including "Typicals" must be validated for each customer application by customer's technical experts. ON Semiconductor does not convey any license under its patent rights nor the rights of others. ON Semiconductor products are not designed, intended, or authorized for use as a critical component in life support systems or any FDA Class 3 medical devices or medical devices with a same or similar classification in a foreign jurisdiction or any devices intended for implantation in the human body. Should Buyer purchase or use ON Semiconductor products for any such unintended or unauthorized application, Buyer shall indemnify and hold ON Semiconductor and its officers, employees, subsidiaries, affiliates, and distributors harmless against all claims, costs, damages, and expenses, and reasonable attorney fees arising out of, directly or indirectly, any claim of personal injury or death associated with such unintended or unauthorized use, even if such claim alleges that ON Semiconductor was negligent regarding the design or manufacture of the part. ON Semiconductor is an Equal Opportunity/Affirmative Action Employer. This literature is subject to all applicable copyright laws and is not for resale in any manner.

PUBLICATION ORDERING INFORMATION

LITERATURE FULFILLMENT:

Literature Distribution Center for ON Semiconductor
19521 E. 32nd Pkwy, Aurora, Colorado 80011 USA
Phone: 303-675-2175 or 800-344-3860 Toll Free USA/Canada
Fax: 303-675-2176 or 800-344-3867 Toll Free USA/Canada
Email: orderlit@onsemi.com

N. American Technical Support: 800-282-9855 Toll Free
USA/Canada
Europe, Middle East and Africa Technical Support:
Phone: 421 33 790 2910
Japan Customer Focus Center
Phone: 81-3-5817-1050

ON Semiconductor Website: www.onsemi.com
Order Literature: <http://www.onsemi.com/orderlit>
For additional information, please contact your local
Sales Representative