

Analog Devices Welcomes Hittite Microwave Corporation

NO CONTENT ON THE ATTACHED DOCUMENT HAS CHANGED



HMC583* Product Page Quick Links

Last Content Update: 11/01/2016

[Comparable Parts](#)

View a parametric search of comparable parts

[Evaluation Kits](#)

- HMC583LP5 Evaluation Board.

[Documentation](#)

Data Sheet

- HMC583 Data Sheet

[Reference Materials](#)

Quality Documentation

- Package/Assembly Qualification Test Report: 32L 5x5mm QFN Package (QTR: 10009 REV: 05)
- Package/Assembly Qualification Test Report: LP3, LP4, LP5 & LP5G (QTR: 2014-00145)
- Package/Assembly Qualification Test Report: Plastic Encapsulated QFN (QTR: 05006 REV: 02)
- Semiconductor Qualification Test Report: GaAs HBT-A (QTR: 2013-00228)

[Design Resources](#)

- HMC583 Material Declaration
- PCN-PDN Information
- Quality And Reliability
- Symbols and Footprints

[Discussions](#)

View all HMC583 EngineerZone Discussions

[Sample and Buy](#)

Visit the product page to see pricing options

[Technical Support](#)

Submit a technical question or find your regional support number

THIS PAGE INTENTIONALLY LEFT BLANK

Typical Applications

Low noise MMIC VCO w/Half Frequency, Divide-by-4 Outputs for:

- Point to Point/Multipoint Radio
- Test Equipment & Industrial Controls
- SATCOM
- Military End-Use

Features

Dual Output: $F_o = 11.5 - 12.8$ GHz
 $F_o/2 = 5.75 - 6.4$ GHz

Pout: +11 dBm

Phase Noise: -110 dBc/Hz @100 kHz Typ.

No External Resonator Needed

32 Lead 5x5mm SMT Package: 25mm²

Functional Diagram

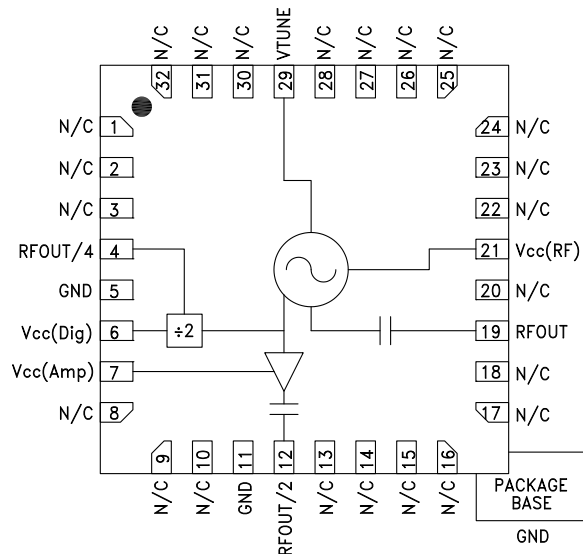

General Description

The HMC583LP5 & HMC583LP5E are GaAs InGaP Heterojunction Bipolar Transistor (HBT) MMIC VCOs. The HMC583LP5 & HMC583LP5E integrate resonators, negative resistance devices, varactor diodes and feature half frequency and divide-by-4 outputs. The VCO's phase noise performance is excellent over temperature, shock, and process due to the oscillator's monolithic structure. Power output is +11 dBm typical from a +5V supply voltage. The prescaler and RF/2 functions can be disabled to conserve current if not required. The voltage controlled oscillator is packaged in a leadless QFN 5x5 mm surface mount package, and requires no external matching components.

Electrical Specifications, $T_A = +25^\circ C$, $V_{cc} (Dig)$, $V_{cc} (Amp)$, $V_{cc} (RF) = +5V$

Parameter	Min.	Typ.	Max.	Units	
Frequency Range	F_o $F_o/2$	11.5 - 12.8 5.75 - 6.4		GHz GHz	
Power Output	RFOUT RFOUT/2 RFOUT/4	+7 +9 -9	+13 +15 -3	dBm dBm dBm	
SSB Phase Noise @ 100 kHz Offset, Vtune= +5V @ RFOUT		-110		dBc/Hz	
Tune Voltage	Vtune	2	12	V	
Supply Current	$I_{cc}(Dig) + I_{cc}(Amp) + I_{cc}(RF)$	310	350	390	mA
Tune Port Leakage Current (Vtune= 12V)			10	μA	
Output Return Loss		2		dB	
Harmonics/Subharmonics	1/2 2nd 3rd	26 22 30		dBc dBc dBc	
Pulling (into a 2.0:1 VSWR)		3		MHz pp	
Pushing @ Vtune= 5V		20		MHz/V	
Frequency Drift Rate		1.0		MHz/ $^\circ C$	

For price, delivery and to place orders: Hittite Microwave Corporation, 20 Alpha Road, Chelmsford, MA 01824

Phone: 978-250-3343 Fax: 978-250-3373 Order On-line at www.hittite.com

Application Support: Phone: 978-250-3343 or apps@hittite.com

MMIC VCO w/ HALF FREQUENCY OUTPUT & DIVIDE-BY-4, 11.5 - 12.8 GHz

Frequency vs. Tuning Voltage, Vcc = +5V

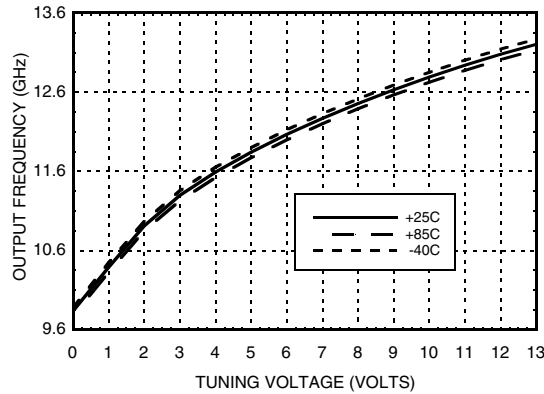

Frequency vs. Tuning Voltage, T = 25°C

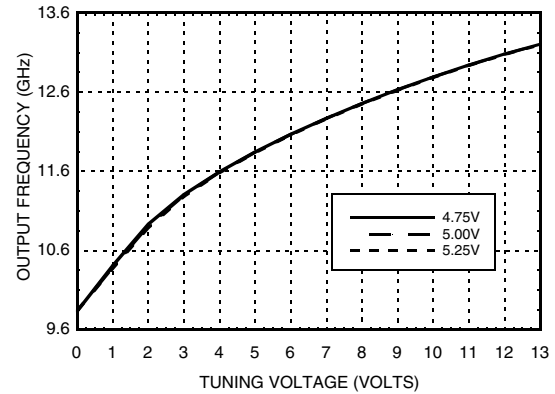

Sensitivity vs. Tuning Voltage, Vcc = +5V

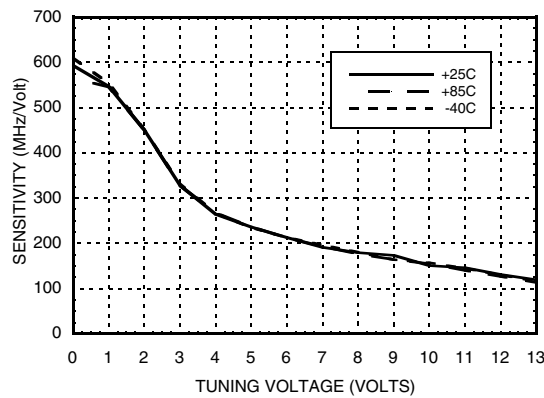

Output Power vs. Tuning Voltage, Vcc = +5V

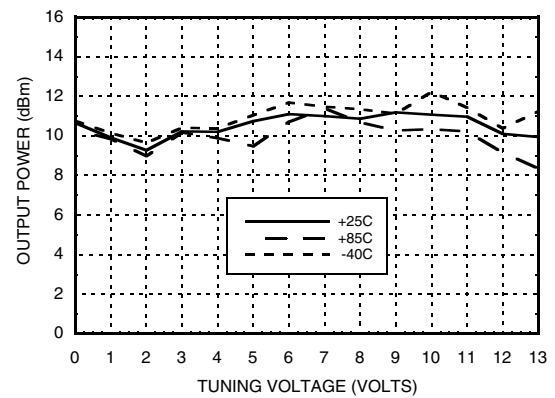

SSB Phase Noise vs. Tuning Voltage

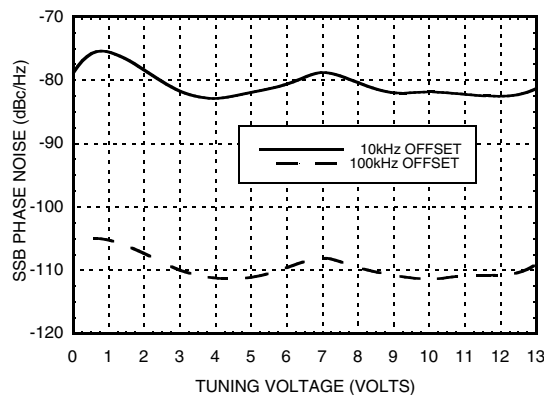

SSB Phase Noise @ Vtune = +5V

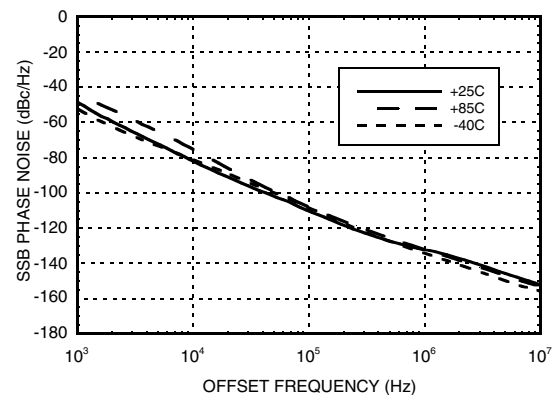



MMIC VCO w/ HALF FREQUENCY OUTPUT & DIVIDE-BY-4, 11.5 - 12.8 GHz

RFOUT/2 Frequency vs. Tuning Voltage, Vcc = +5V

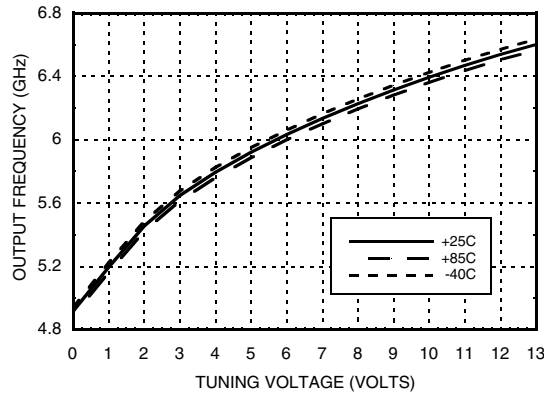

RFOUT/2 Output Power vs. Tuning Voltage, Vcc = +5V

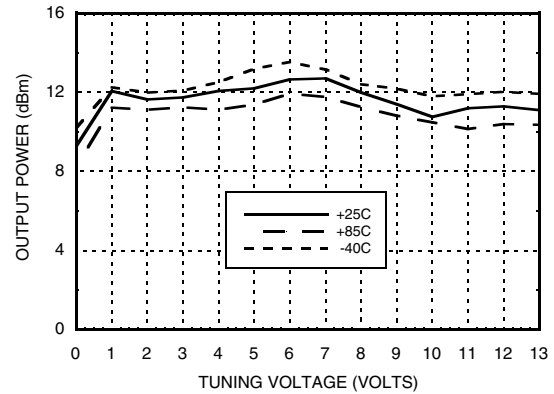

Divide-by-4 Frequency vs. Tuning Voltage, Vcc = +5V

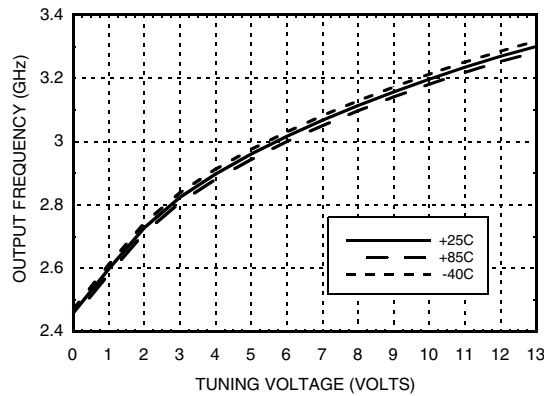

Divide-by-4 Output Power vs. Tuning Voltage, Vcc = +5V

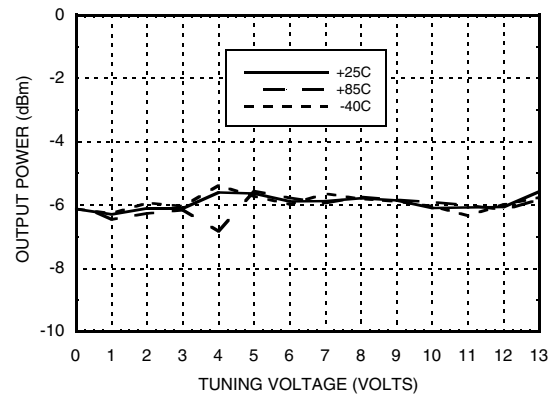

Absolute Maximum Ratings

Vcc(Dig), Vcc(Amp), Vcc(RF)	+5.5 Vdc
Vtune	0 to +15V
Junction Temperature	135 °C
Continuous Pdiss (T=85 °C) (derate 43.5 mW/C above 85 °C)	2.17 W
Thermal Resistance (junction to ground paddle)	23 °C/W
Storage Temperature	-65 to +150 °C
Operating Temperature	-40 to +85 °C
ESD Sensitivity (HBM)	Class 1A

Typical Supply Current vs. Vcc

Vcc (V)	Icc (mA)
4.75	320
5.00	350
5.25	380

Note: VCO will operate over full voltage range shown above.



**ELECTROSTATIC SENSITIVE DEVICE
OBSERVE HANDLING PRECAUTIONS**

MMIC VCO w/ HALF FREQUENCY OUTPUT & DIVIDE-BY-4, 11.5 - 12.8 GHz

Outline Drawing

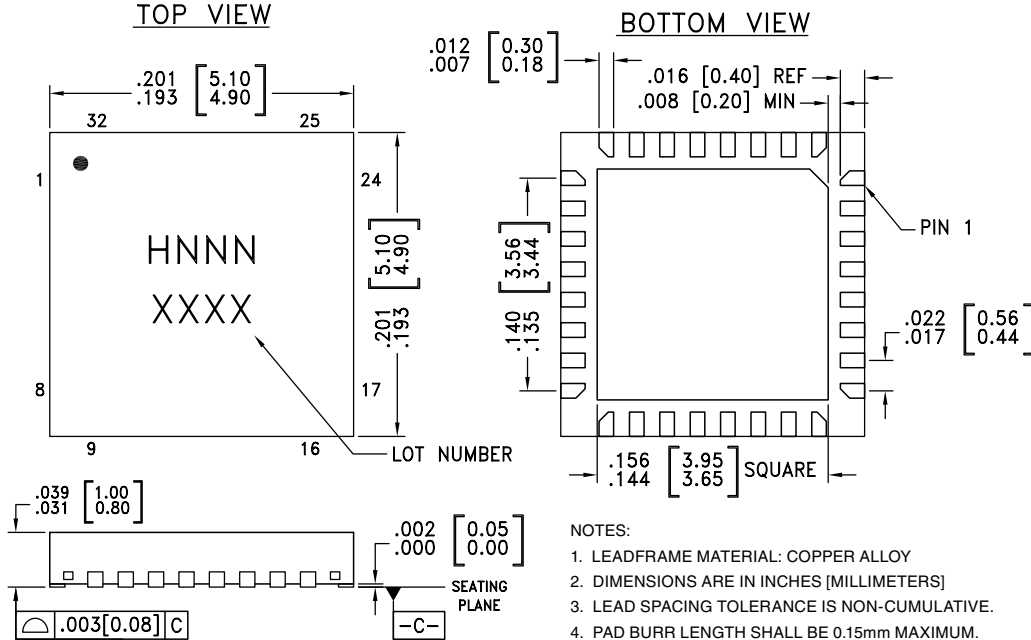

- NOTES:
1. LEADFRAME MATERIAL: COPPER ALLOY
 2. DIMENSIONS ARE IN INCHES [MILLIMETERS]
 3. LEAD SPACING TOLERANCE IS NON-CUMULATIVE.
 4. PAD BURR LENGTH SHALL BE 0.15mm MAXIMUM. PAD BURR HEIGHT SHALL BE 0.05mm MAXIMUM.
 5. PACKAGE WARP SHALL NOT EXCEED 0.05mm.
 6. ALL GROUND LEADS AND GROUND PADDLE MUST BE SOLDERED TO PCB RF GROUND.
 7. REFER TO HITTITE APPLICATION NOTE FOR SUGGESTED LAND PATTERN.

Package Information

Part Number	Package Body Material	Lead Finish	MSL Rating	Package Marking ^[3]
HMC583LP5	Low Stress Injection Molded Plastic	Sn/Pb Solder	MSL3 ^[1]	H583 XXXX
HMC583LP5E	RoHS-compliant Low Stress Injection Molded Plastic	100% matte Sn	MSL3 ^[2]	H583 XXXX

- [1] Max peak reflow temperature of 235 °C
 [2] Max peak reflow temperature of 260 °C
 [3] 4-Digit lot number XXXX



Pin Descriptions

Pin Number	Function	Description	Interface Schematic
1 - 3, 8 - 10, 13 - 18, 20, 22 - 28, 30 - 32	N/C	No Connection. These pins may be connected to RF/DC ground. Performance will not be affected.	
4	RFOUT/4	Divide-by-4 output. DC block required.	
6	Vcc (Dig)	Supply voltage for prescaler. If prescaler is not required, this pin may be left open to conserve approximately 65 mA of current.	

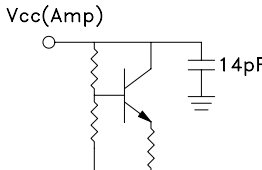
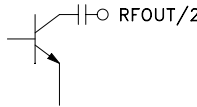
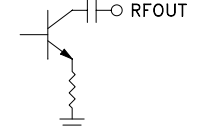
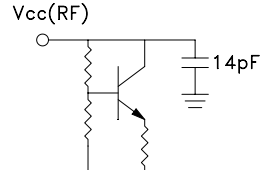
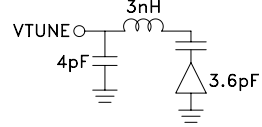

**MMIC VCO w/ HALF FREQUENCY OUTPUT
& DIVIDE-BY-4, 11.5 - 12.8 GHz**

Pin Descriptions

Pin Number	Function	Description	Interface Schematic
7	Vcc (Amp)	Supply voltage, for RFOUT/2 output. If RFOUT/2 is not required, this pin may be left open to conserve approximately 30 mA of current.	
12	RFOUT/2	Half frequency output (AC coupled).	
19	RF OUT	RF output (AC coupled).	
21	Vcc (RF)	Supply Voltage, +5V	
29	VTUNE	Control voltage and modulation input. Modulation bandwidth dependent on drive source impedance. See "Determining the FM Bandwidth of a Wideband Varactor Tuned VCO" application note.	
5, 11, Paddle	GND	Package bottom has an exposed metal paddle that must be connected to RF/DC ground.	

Typical Application Circuit

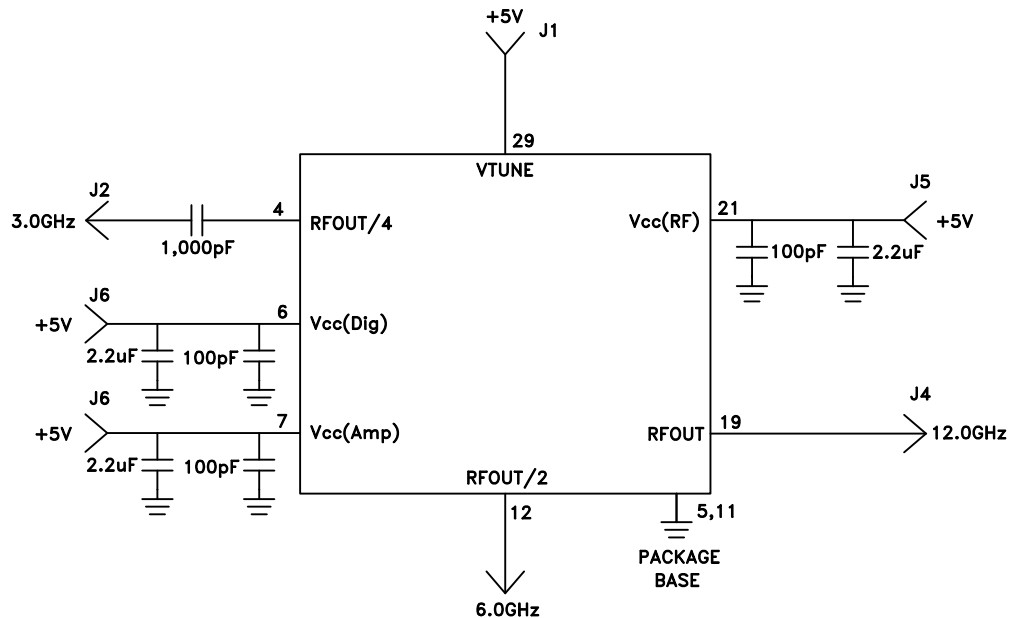

Evaluation PCB

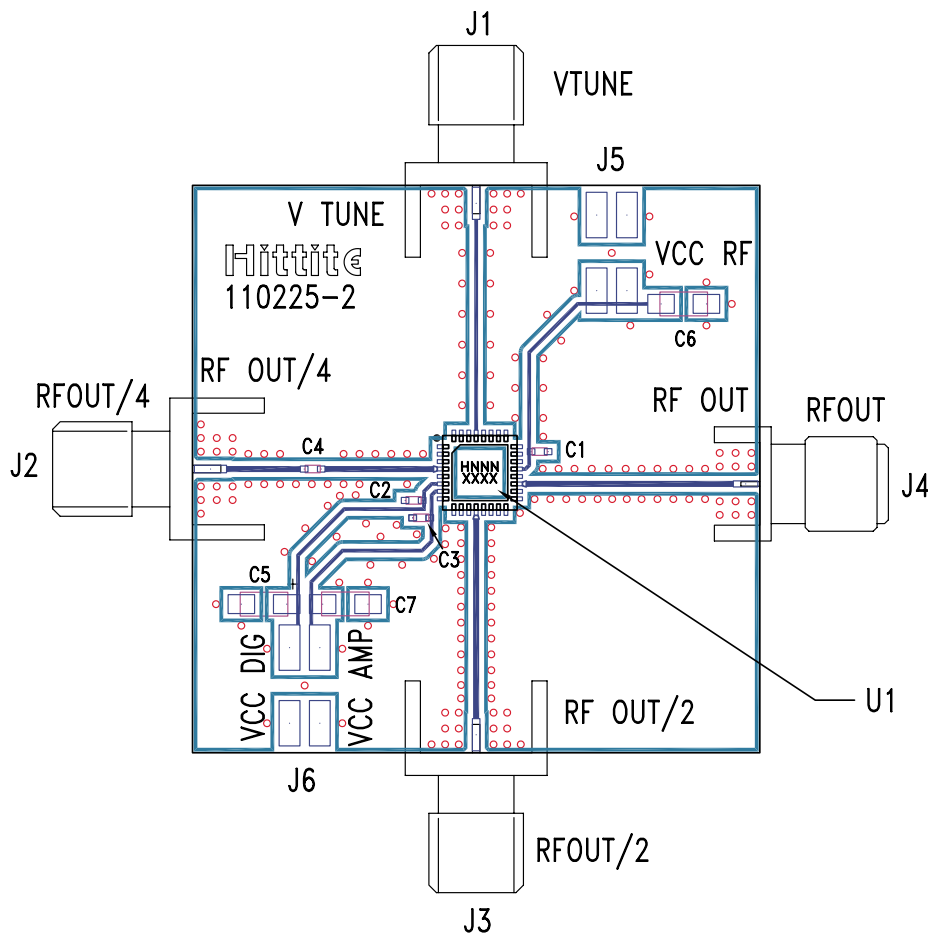

List of Materials for Evaluation PCB 110227 [1]

Item	Description
J1 - J4	PCB Mount SMA RF Connector
J5 - J6	2 mm DC Header
C1 - C3	100 pF Capacitor, 0402 Pkg.
C4	1,000 pF Capacitor, 0402 Pkg.
C5 - C7	2.2 μ F Tantalum Capacitor
U1	HMC583LP5 / HMC583LP5E VCO
PCB [2]	110225 Eval Board

[1] Reference this number when ordering complete evaluation PCB

[2] Circuit Board Material: Rogers 4350

The circuit board used in the application should use RF circuit design techniques. Signal lines should have 50 Ohm impedance while the package ground leads and backside ground paddle should be connected directly to the ground plane similar to that shown. A sufficient number of via holes should be used to connect the top and bottom ground planes. The evaluation circuit board shown is available from Hittite upon request.