

FEATURES

Low drift 2.5 V reference: 2 ppm/°C typical
 Tiny package: 3 mm × 3 mm, 16-lead LFCSP
 Total unadjusted error (TUE): ±0.1% of full-scale range (FSR) maximum

Offset error: ±1.5 mV maximum
 Gain error: ±0.1% of FSR maximum
 High drive capability: 20 mA, 0.5 V from supply rails
 User selectable gain of 1 or 2 (GAIN pin)
 Reset to zero scale or midscale (RSTSEL pin)
 1.8 V logic compatibility
 Low glitch: 0.5 nV-sec
 400 kHz I²C-compatible serial interface
 Robust 3.5 kV HBM and 1.5 kV FICDM ESD rating
 Low power: 3.3 mW at 3 V
 2.7 V to 5.5 V power supply
 -40°C to +105°C temperature range

APPLICATIONS

Optical transceivers
 Base station power amplifiers
 Process controls (programmable logic controller [PLC] I/O cards)
 Industrial automation
 Data acquisition systems

GENERAL DESCRIPTION

The AD5338R, a member of the *nano*DAC® family, is a low power, dual, 10-bit buffered voltage output digital-to-analog converter (DAC). The device includes a 2.5 V, 2 ppm/°C internal reference (enabled by default) and a gain select pin giving a full-scale output of 2.5 V (gain = 1) or 5 V (gain = 2). The AD5338R operates from a single 2.7 V to 5.5 V supply, is guaranteed monotonic by design, and exhibits less than 0.1% FSR gain error and 1.5 mV offset error performance. The device is available in a 3 mm × 3 mm LFCSP and a TSSOP package.

The AD5338R also incorporates a power-on reset circuit and a RSTSEL pin that ensures that the DAC outputs power up to zero scale or midscale and remain there until a valid write takes place. It contains a per channel power-down feature that reduces the current consumption of the device to 4 μA at 3 V while in power-down mode.

The AD5338R uses a versatile 2-wire serial interface that operates at clock rates up to 400 kHz and includes a V_{LOGIC} pin intended for 1.8 V/3 V/5 V logic.

Rev. 0

[Document Feedback](#)

Information furnished by Analog Devices is believed to be accurate and reliable. However, no responsibility is assumed by Analog Devices for its use, nor for any infringements of patents or other rights of third parties that may result from its use. Specifications subject to change without notice. No license is granted by implication or otherwise under any patent or patent rights of Analog Devices. Trademarks and registered trademarks are the property of their respective owners.

FUNCTIONAL BLOCK DIAGRAM

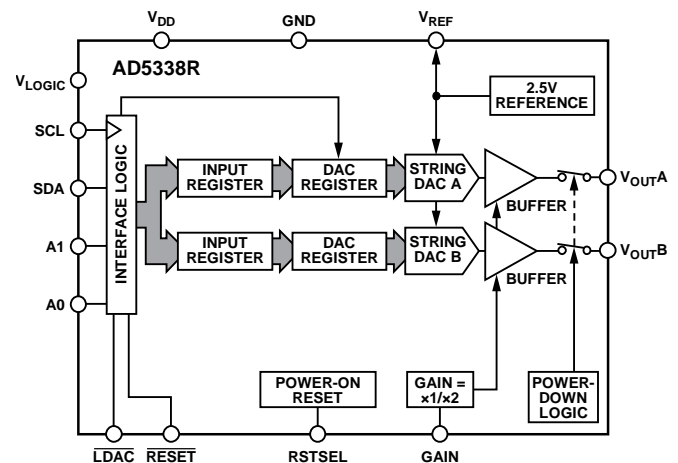

Figure 1.

Table 1. Related Devices

Interface	Reference	12-Bit	10-Bit
SPI	Internal	AD5687R	AD5313R ¹
	External	AD5687	AD5313 ¹
I ² C	Internal	AD5697R	AD5338R ¹
	External		AD5338 ¹

¹ The AD5338R and the AD5338 are not pin-to-pin or software compatible. The AD5313R and the AD5313 are not pin-to-pin or software compatible.

PRODUCT HIGHLIGHTS

- Precision DC Performance.
 - TUE: ±0.1% of FSR maximum
 - Offset error: ±1.5 mV maximum
 - Gain error: ±0.1% of FSR maximum
- Low Drift 2.5 V On-Chip Reference.
 - 2 ppm/°C typical temperature coefficient
 - 5 ppm/°C maximum temperature coefficient
- Two Package Options.
 - 3 mm × 3 mm, 16-lead LFCSP
 - 16-lead TSSOP

AD5338R* Product Page Quick Links

Last Content Update: 11/01/2016

[Comparable Parts](#)

View a parametric search of comparable parts

[Documentation](#)

Data Sheet

- AD5338R: Dual, 10-Bit nanoDAC with 2 ppm/°C Reference, I2C Interface Data Sheet

[Reference Materials](#)

Press

- Analog Devices' nanoDAC+™ Converters Expand Industry's Best D/A Converter Performance and Smallest Packages

[Design Resources](#)

- AD5338R Material Declaration
- PCN-PDN Information
- Quality And Reliability
- Symbols and Footprints

[Discussions](#)

View all AD5338R EngineerZone Discussions

[Sample and Buy](#)

Visit the product page to see pricing options

[Technical Support](#)

Submit a technical question or find your regional support number

* This page was dynamically generated by Analog Devices, Inc. and inserted into this data sheet. Note: Dynamic changes to the content on this page does not constitute a change to the revision number of the product data sheet. This content may be frequently modified.

TABLE OF CONTENTS

Features	1	Serial Operation	19
Applications	1	Write Operation.....	19
Functional Block Diagram	1	Read Operation.....	20
General Description	1	Multiple DAC Readback Sequence	20
Product Highlights	1	Power-Down Operation	21
Revision History	2	Load DAC (Hardware $\overline{\text{LDAC}}$ Pin).....	22
Specifications.....	3	$\overline{\text{LDAC}}$ Mask Register	22
AC Characteristics.....	5	Hardware Reset ($\overline{\text{RESET}}$)	23
Timing Characteristics	6	Reset Select Pin (RSTSEL)	23
Absolute Maximum Ratings.....	7	Internal Reference Setup	23
ESD Caution.....	7	Solder Heat Reflow.....	23
Pin Configurations and Function Descriptions	8	Long-Term Temperature Drift	23
Typical Performance Characteristics	9	Thermal Hysteresis	24
Terminology	15	Applications Information	25
Theory of Operation	17	Microprocessor Interfacing.....	25
Digital-to-Analog Converter	17	AD5338R to ADSP-BF531 Interface	25
Transfer Function	17	Layout Guidelines.....	25
DAC Architecture.....	17	Galvanically Isolated Interface	25
Serial Interface	18	Outline Dimensions	26
Write and Update Commands.....	18	Ordering Guide	26

REVISION HISTORY

2/13—Revision 0: Initial Version

SPECIFICATIONS

$V_{DD} = 2.7\text{ V to }5.5\text{ V}$; $1.8\text{ V} \leq V_{LOGIC} \leq 5.5\text{ V}$; and all specifications T_{MIN} to T_{MAX} , unless otherwise noted. $R_L = 2\text{ k}\Omega$; and $C_L = 200\text{ pF}$.

Table 2.

Parameter	Min	Typ	Max	Unit	Test Conditions/Comments
STATIC PERFORMANCE¹					
Resolution	10			Bits	
Relative Accuracy		± 0.12	± 0.5	LSB	
Differential Nonlinearity			± 0.5	LSB	Guaranteed monotonic by design
Zero-Code Error		0.4	1.5	mV	All 0s loaded to DAC register
Offset Error		+0.1	± 1.5	mV	
Full-Scale Error		+0.01	± 0.1	% of FSR	All 1s loaded to DAC register
Gain Error		± 0.02	± 0.1	% of FSR	
Total Unadjusted Error		± 0.01	± 0.1	% of FSR	External reference; gain = 2; TSSOP
			± 0.2	% of FSR	Internal reference; gain = 1; TSSOP
Offset Error Drift ²		± 1		$\mu\text{V}/^\circ\text{C}$	
Gain Temperature Coefficient ²		± 1		ppm	Of FSR/ $^\circ\text{C}$
DC Power Supply Rejection Ratio ²		0.15		mV/V	DAC code = midscale; $V_{DD} = 5\text{ V} \pm 10\%$
DC Crosstalk ²					
		± 2		μV	Due to single channel, full-scale output change
		± 3		$\mu\text{V}/\text{mA}$	Due to load current change
		± 2		μV	Due to powering down (per channel)
OUTPUT CHARACTERISTICS²					
Output Voltage Range	0		V_{REF}	V	Gain = 1
	0		$2 \times V_{REF}$	V	Gain = 2, see Figure 26
Capacitive Load Stability		2		nF	$R_L = \infty$
		10		nF	$R_L = 1\text{ k}\Omega$
Resistive Load ³	1			k Ω	
Load Regulation		80		$\mu\text{V}/\text{mA}$	$5\text{ V} \pm 10\%$, DAC code = midscale; $-30\text{ mA} \leq I_{OUT} \leq +30\text{ mA}$
		80		$\mu\text{V}/\text{mA}$	$3\text{ V} \pm 10\%$, DAC code = midscale; $-20\text{ mA} \leq I_{OUT} \leq +20\text{ mA}$
Short-Circuit Current ⁴		40		mA	
Load Impedance at Rails ⁵		25		Ω	See Figure 26
Power-Up Time		2.5		μs	Coming out of power-down mode; $V_{DD} = 5\text{ V}$
REFERENCE OUTPUT					
Output Voltage ⁶	2.4975		2.5025	V	At ambient
Reference Temperature Coefficient ^{7,8}		2	5	ppm/ $^\circ\text{C}$	See the Terminology section
Output Impedance ²		0.04		Ω	
Output Voltage Noise ²		12		$\mu\text{V p-p}$	0.1 Hz to 10 Hz
Output Voltage Noise Density ²		240		nV/ $\sqrt{\text{Hz}}$	At ambient; $f = 10\text{ kHz}$, $C_L = 10\text{ nF}$
Load Regulation Sourcing ²		20		$\mu\text{V}/\text{mA}$	At ambient
Load Regulation Sinking ²		40		$\mu\text{V}/\text{mA}$	At ambient
Output Current Load Capability ²		± 5		mA	$V_{DD} \geq 3\text{ V}$
Line Regulation ²		100		$\mu\text{V}/\text{V}$	At ambient
Long-Term Stability/Drift ²		12		ppm	After 1000 hours at 125°C
Thermal Hysteresis ²		125		ppm	First cycle
		25		ppm	Additional cycles
LOGIC INPUTS²					
Input Current			± 2	μA	Per pin
Input Low Voltage, V_{INL}			$0.3 \times V_{LOGIC}$	V	
Input High Voltage, V_{INH}	$0.7 \times V_{LOGIC}$			V	
Pin Capacitance		2		pF	

Parameter	Min	Typ	Max	Unit	Test Conditions/Comments
LOGIC OUTPUTS (SDA) ²					
Output Low Voltage, V_{OL}			0.4	V	$I_{SINK} = 3 \text{ mA}$
Floating State Output Capacitance		4		pF	
POWER REQUIREMENTS					
V_{LOGIC}	1.8		5.5	V	Gain = 1 Gain = 2 $V_{IH} = V_{DD}$, $V_{IL} = \text{GND}$, $V_{DD} = 2.7 \text{ V to } 5.5 \text{ V}$ Internal reference off Internal reference on, at full scale –40°C to +85°C –40°C to +105°C
I_{LOGIC}			3	μA	
V_{DD}	2.7		5.5	V	
I_{DD}	$V_{REF} + 1.5$		5.5	V	
Normal Mode ⁹		0.59	0.7	mA	
		1.1	1.3	mA	
All Power-Down Modes ¹⁰		1	4	μA	
			6	μA	

¹ DC specifications tested with the outputs unloaded, unless otherwise noted. Upper dead band = 10 mV and exists only when $V_{REF} = V_{DD}$ with gain = 1 or when $V_{REF}/2 = V_{DD}$ with gain = 2. Linearity calculated using a reduced code range of 4 to 1020.

² Guaranteed by design and characterization; not production tested.

³ Channel A can have an output current of up to 30 mA. Similarly, Channel B can have an output current of up to 30 mA up to a junction temperature of 100°C.

⁴ $V_{DD} = 5 \text{ V}$. The device includes current limiting that is intended to protect the device during temporary overload conditions. Junction temperature can be exceeded during current limit. Operation above the specified maximum operation junction temperature may impair device reliability.

⁵ When drawing a load current at either rail, the output voltage headroom with respect to that rail is limited by the 25 Ω typical channel resistance of the output device. For example, when sinking 1 mA, the minimum output voltage = $25 \Omega \times 1 \text{ mA} = 25 \text{ mV}$ (see Figure 26).

⁶ Initial accuracy presolder reflow is $\pm 750 \mu\text{V}$; output voltage includes the effects of preconditioning drift. See the Internal Reference Setup section.

⁷ Reference is trimmed and tested at two temperatures and is characterized from –40°C to +105°C.

⁸ Reference temperature coefficient is calculated as per the box method. See the Terminology section for further information.

⁹ Interface inactive. Both DACs active. DAC outputs unloaded.

¹⁰ Both DACs powered down.

AC CHARACTERISTICS

$V_{DD} = 2.7\text{ V to }5.5\text{ V}$; $R_L = 2\text{ k}\Omega$ to GND; $C_L = 200\text{ pF}$ to GND; $1.8\text{ V} \leq V_{LOGIC} \leq 5.5\text{ V}$; all specifications T_{MIN} to T_{MAX} , unless otherwise noted. Guaranteed by design and characterization; not production tested.

Table 3.

Parameter ¹	Min	Typ	Max	Unit	Test Conditions/Comments ²
Output Voltage Settling Time		5	7	μs	$\frac{1}{4}$ to $\frac{3}{4}$ scale settling to ± 2 LSB
Slew Rate		0.8		$\text{V}/\mu\text{s}$	
Digital-to-Analog Glitch Impulse		0.5		$\text{nV}\cdot\text{sec}$	1 LSB change around major carry
Digital Feedthrough		0.13		$\text{nV}\cdot\text{sec}$	
Digital Crosstalk		0.1		$\text{nV}\cdot\text{sec}$	
Analog Crosstalk		0.2		$\text{nV}\cdot\text{sec}$	
DAC-to-DAC Crosstalk		0.3		$\text{nV}\cdot\text{sec}$	
Total Harmonic Distortion (THD) ³		-80		dB	At ambient, bandwidth = 20 kHz, $V_{DD} = 5\text{ V}$, $f_{OUT} = 1\text{ kHz}$
Output Noise Spectral Density		300		$\text{nV}/\sqrt{\text{Hz}}$	DAC code = midscale, 10 kHz; gain = 2
Output Noise		6		$\mu\text{V p-p}$	0.1 Hz to 10 Hz
Signal-to-Noise Ratio (SNR)		90		dB	At ambient, bandwidth = 20 kHz, $V_{DD} = 5\text{ V}$, $f_{OUT} = 1\text{ kHz}$
Spurious-Free Dynamic Range (SFDR)		83		dB	At ambient, bandwidth = 20 kHz, $V_{DD} = 5\text{ V}$, $f_{OUT} = 1\text{ kHz}$
Signal-to-Noise-and-Distortion Ratio (SINAD)		80		dB	At ambient, bandwidth = 20 kHz, $V_{DD} = 5\text{ V}$, $f_{OUT} = 1\text{ kHz}$

¹ See the Terminology section.

² Temperature range is -40°C to $+105^\circ\text{C}$, typical at 25°C .

³ Digitally generated sine wave at 1 kHz.

TIMING CHARACTERISTICS

$V_{DD} = 2.5\text{ V to }5.5\text{ V}$; $1.8\text{ V} \leq V_{LOGIC} \leq 5.5\text{ V}$; all specifications T_{MIN} to T_{MAX} , unless otherwise noted. See Figure 2.

Table 4.

Parameter ¹	Min	Max	Unit	Test Conditions/Comments
t_1	2.5		μs	SCL cycle time
t_2	0.6		μs	SCL high time, t_{HIGH}
t_3	1.3		μs	SCL low time, t_{LOW}
t_4	0.6		μs	Start/repeated start condition hold time, $t_{HD,STA}$
t_5	100		ns	Data setup time, $t_{SU,DAT}$
t_6^2	0	0.9	μs	Data hold time, $t_{HD,DAT}$
t_7	0.6		μs	Setup time for repeated start, $t_{SU,STA}$
t_8	0.6		μs	Stop condition setup time, $t_{SU,STO}$
t_9	1.3		μs	Bus free time between a stop and a start condition, t_{BUF}
t_{10}	0	300	ns	Rise time of SCL and SDA when receiving, t_R
t_{11}	$20 + 0.1C_B^3$	300	ns	Fall time of SDA and SCL when transmitting/receiving, t_F
t_{12}	20		ns	LDAC pulse width
t_{13}	400		ns	SCL rising edge to LDAC rising edge
C_B^3		400	pF	Capacitive load for each bus line

¹ Guaranteed by design and characterization; not production tested.

² A master device must provide a hold time of at least 300 ns for the SDA signal (referred to the V_{IH} minimum of the SCL signal) to bridge the undefined region of the falling edge of the SCL.

³ C_B is the total capacitance of one bus line in pF. t_R and t_F measured between $0.3 V_{DD}$ and $0.7 V_{DD}$.

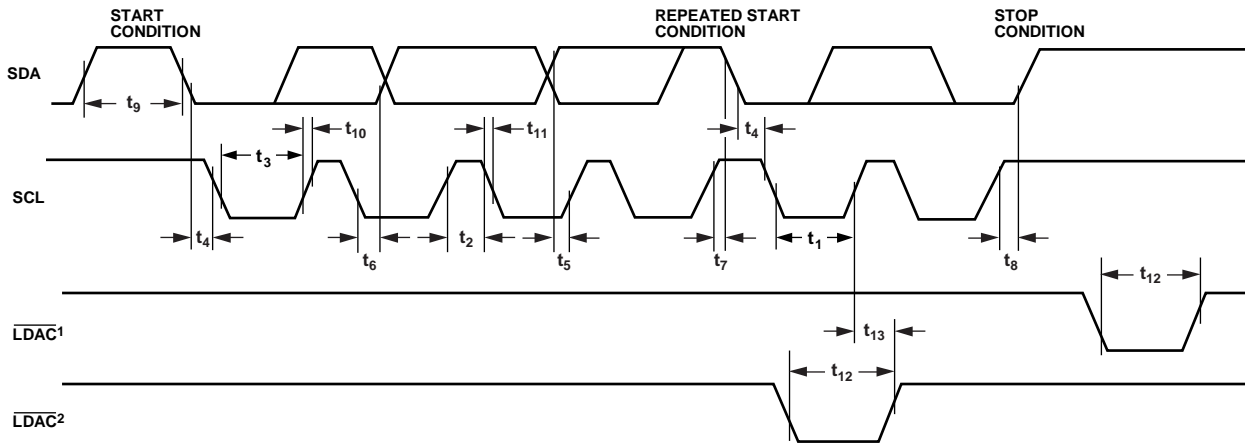

NOTES
¹ASYNCHRONOUS LDAC UPDATE MODE.
²SYNCHRONOUS LDAC UPDATE MODE.

Figure 2. 2-Wire Serial Interface Timing Diagram

11252-002

ABSOLUTE MAXIMUM RATINGS

$T_A = 25^\circ\text{C}$, unless otherwise noted.

Table 5.

Parameter	Rating
V_{DD} to GND	-0.3 V to +7 V
V_{LOGIC} to GND	-0.3 V to +7 V
V_{OUT} to GND	-0.3 V to $V_{DD} + 0.3$ V
V_{REF} to GND	-0.3 V to $V_{DD} + 0.3$ V
Digital Input Voltage to GND ¹	-0.3 V to $V_{LOGIC} + 0.3$ V
SDA and SCL to GND	-0.3 V to +7 V
Operating Temperature Range	-40°C to +105°C
Storage Temperature Range	-65°C to +150°C
Junction Temperature	125°C
16-Lead TSSOP, θ_{JA} Thermal Impedance, 0 Airflow (4-Layer Board)	112.6°C/W
16-Lead LFCSP, θ_{JA} Thermal Impedance, 0 Airflow (4-Layer Board)	70°C/W
Reflow Soldering Peak Temperature, Pb Free (J-STD-020)	260°C
ESD ²	3.5 kV
FICDM	1.5 kV

¹ Excluding SDA and SCL.

² Human body model (HBM) classification.

Stresses above those listed under Absolute Maximum Ratings may cause permanent damage to the device. This is a stress rating only; functional operation of the device at these or any other conditions above those indicated in the operational section of this specification is not implied. Exposure to absolute maximum rating conditions for extended periods may affect device reliability.

ESD CAUTION



ESD (electrostatic discharge) sensitive device. Charged devices and circuit boards can discharge without detection. Although this product features patented or proprietary protection circuitry, damage may occur on devices subjected to high energy ESD. Therefore, proper ESD precautions should be taken to avoid performance degradation or loss of functionality.

PIN CONFIGURATIONS AND FUNCTION DESCRIPTIONS

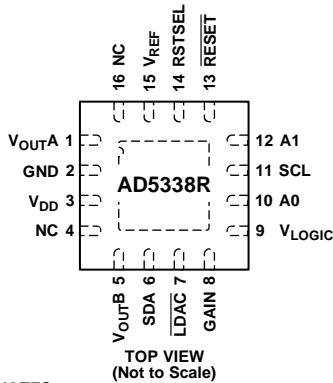

NOTES
 1. NC = NO CONNECT. DO NOT CONNECT TO THIS PIN.
 2. THE EXPOSED PAD MUST BE TIED TO GND.

Figure 3. 16-Lead LFCSP Pin Configuration

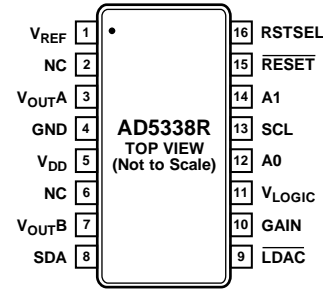

NOTES
 1. NC = NO CONNECT. DO NOT CONNECT TO THIS PIN.

Figure 4. 16-Lead TSSOP Pin Configuration

Table 6. Pin Function Descriptions

Pin No.		Mnemonic	Description
LFCSP	TSSOP		
1	3	V _{OUTA}	Analog Output Voltage from DAC A. The output amplifier has rail-to-rail operation.
16	2	NC	No Connect. Do not connect to this pin.
2	4	GND	Ground Reference Point for All Circuitry on the Part.
3	5	V _{DD}	Power Supply Input. This part can be operated from 2.7 V to 5.5 V. Decouple the supply with a 10 μF capacitor in parallel with a 0.1 μF capacitor to GND.
4	6	NC	No Connect. Do not connect to this pin.
5	7	V _{OUTB}	Analog Output Voltage from DAC B. The output amplifier has rail-to-rail operation.
6	8	SDA	Serial Data Input. This pin is used in conjunction with the SCL line to clock data into or out of the 24-bit input shift register. SDA is a bidirectional, open-drain data line that should be pulled to the supply with an external pull-up resistor.
7	9	LDAC	LDAC can be operated in two modes, asynchronous and synchronous. Pulsing this pin low allows any or all DAC registers to be updated if the input registers have new data. This allows both DAC outputs to simultaneously update. This pin can also be tied permanently low.
8	10	GAIN	Gain Select. When this pin is tied to GND, both DAC outputs have a span from 0 V to V _{REF} . If this pin is tied to V _{LOGIC} , both DACs output a span of 0 V to 2 × V _{REF} .
9	11	V _{LOGIC}	Digital Power Supply. Voltage ranges from 1.8 V to 5.5 V.
10	12	A0	Address Input. Sets the first LSB of the 7-bit slave address.
11	13	SCL	Serial Clock Line. This is used in conjunction with the SDA line to clock data into or out of the 24-bit input register.
12	14	A1	Address Input. Sets the second LSB of the 7-bit slave address.
13	15	RESET	Asynchronous Reset Input. The RESET input is falling edge sensitive. When RESET is low, all LDAC pulses are ignored. When RESET is activated, the input register and the DAC register are updated with zero scale or midscale, depending on the state of the RSTSEL pin.
14	16	RSTSEL	Power-On Reset Select. Tying this pin to GND powers up both DACs to zero scale. Tying this pin to V _{LOGIC} powers up both DACs to midscale.
15	1	V _{REF}	Reference Voltage. The AD5338R has a common reference pin. When using the internal reference, this is the reference output pin. When using an external reference, this is the reference input pin. The default for this pin is as a reference output.
	Not applicable	EPAD	Exposed Pad. The exposed pad must be tied to GND.

TYPICAL PERFORMANCE CHARACTERISTICS

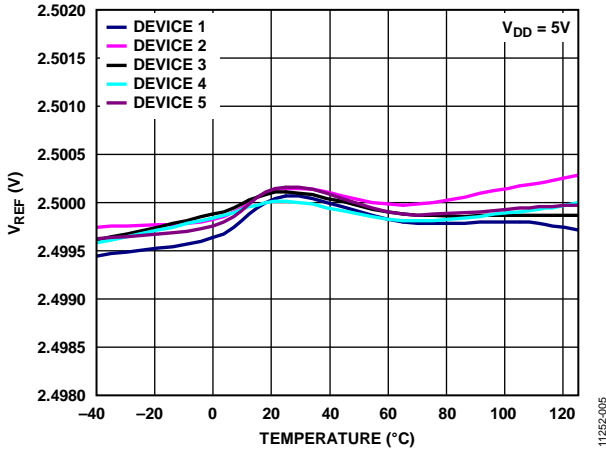

Figure 5. Internal Reference Voltage vs. Temperature

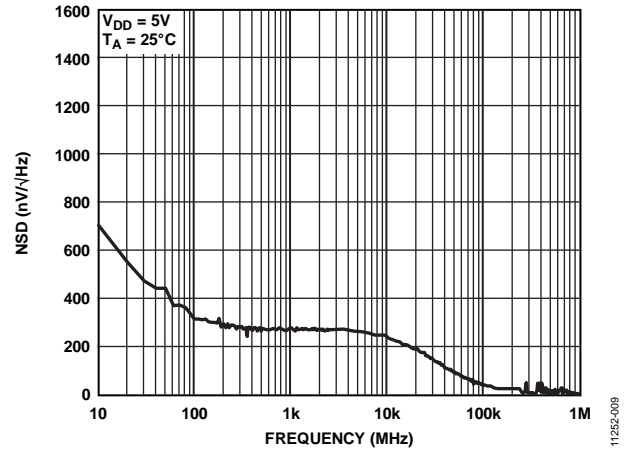

Figure 8. Internal Reference Noise Spectral Density vs. Frequency

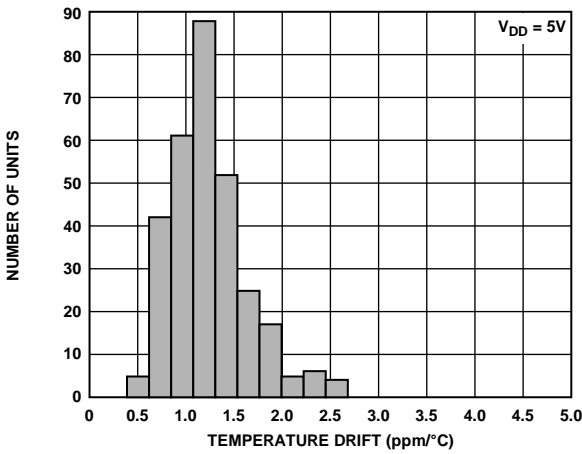

Figure 6. Reference Output Temperature Drift Histogram

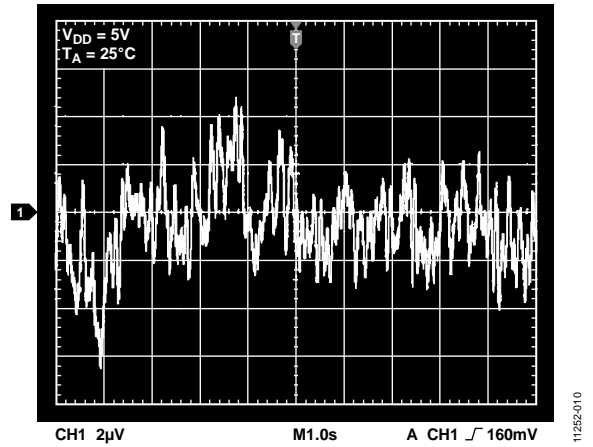

Figure 9. Internal Reference Noise, 0.1 Hz to 10 Hz

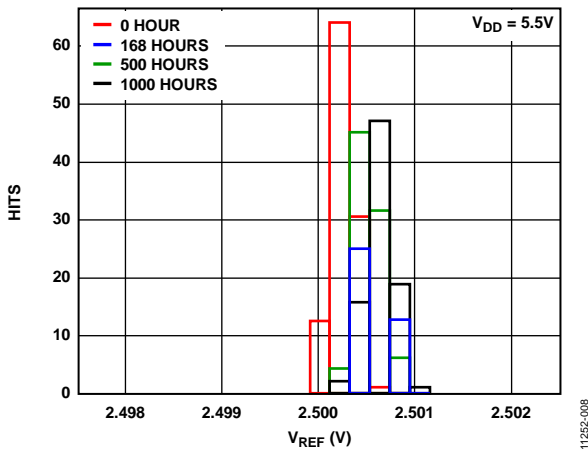

Figure 7. Reference Long-Term Stability/Drift

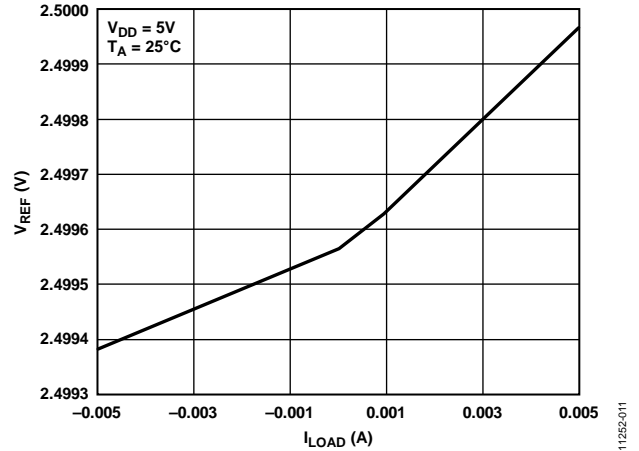

Figure 10. Internal Reference Voltage vs. Load Current

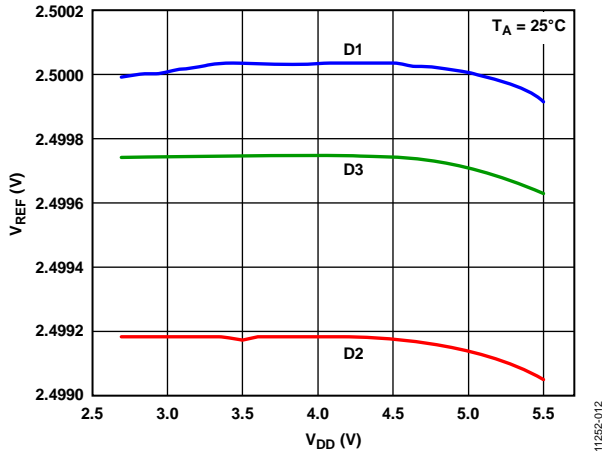

Figure 11. Internal Reference Voltage vs. Supply Voltage

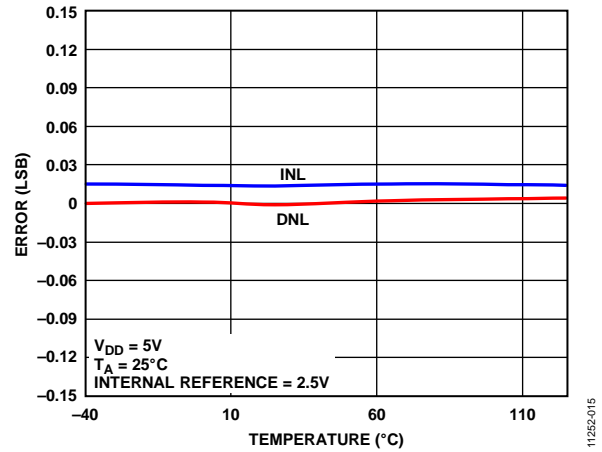

Figure 14. INL Error and DNL Error vs. Temperature

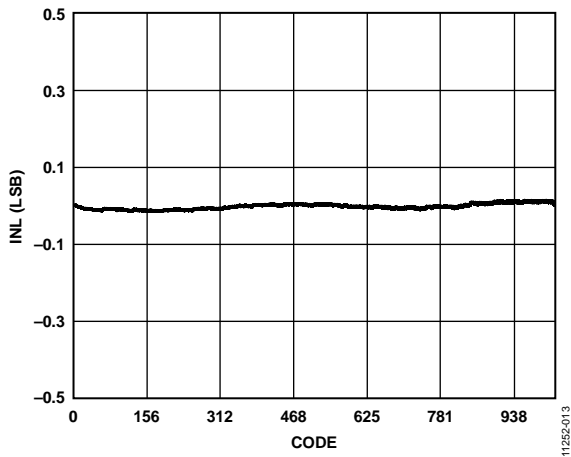

Figure 12. Integral Nonlinearity (INL)

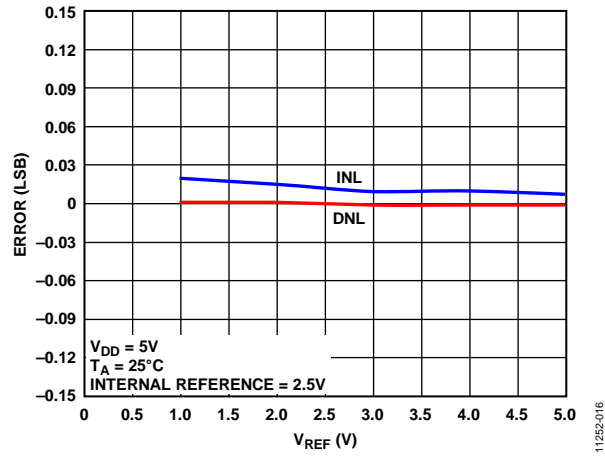

Figure 15. INL Error and DNL Error vs. V_{REF}

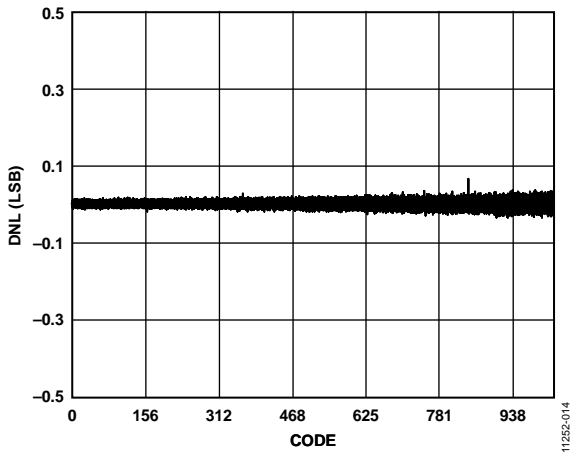

Figure 13. Differential Nonlinearity (DNL)

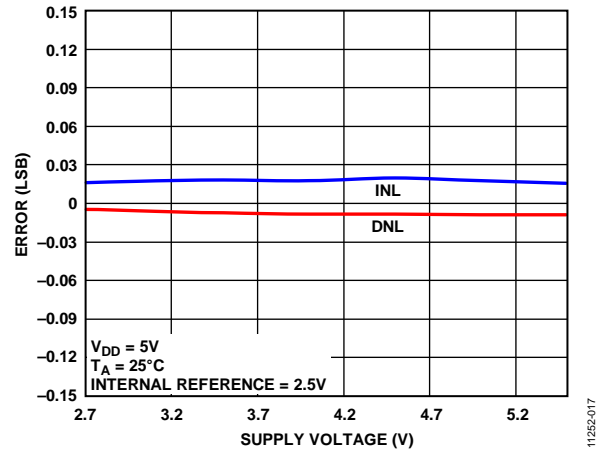

Figure 16. INL Error and DNL Error vs. Supply Voltage

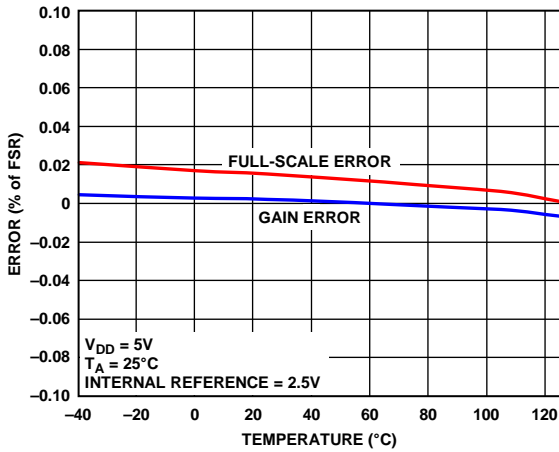

Figure 17. Gain Error and Full-Scale Error vs. Temperature

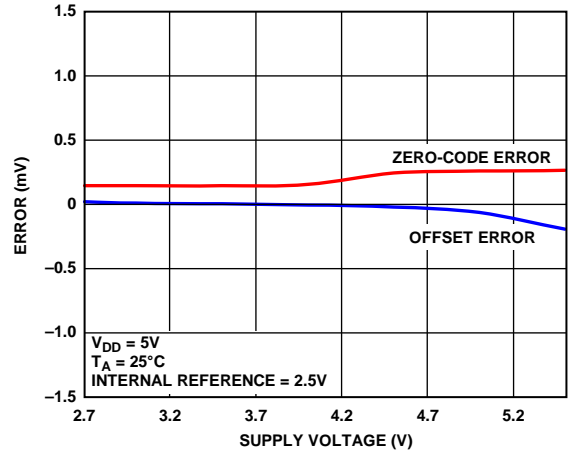

Figure 20. Zero-Code Error and Offset Error vs. Supply Voltage

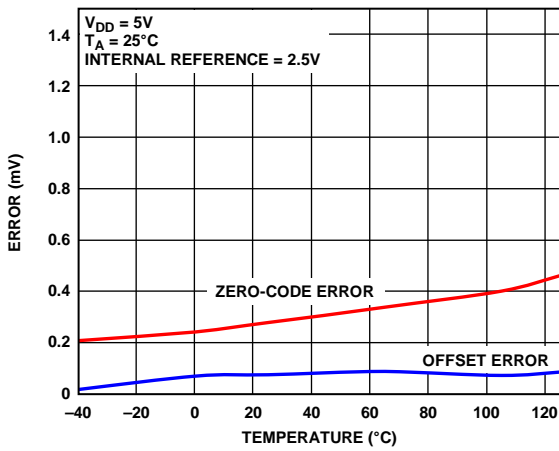

Figure 18. Zero-Code Error and Offset Error vs. Temperature

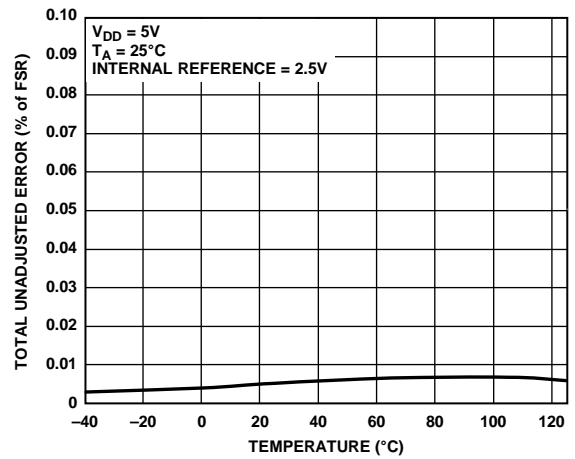

Figure 21. Total Unadjusted Error vs. Temperature

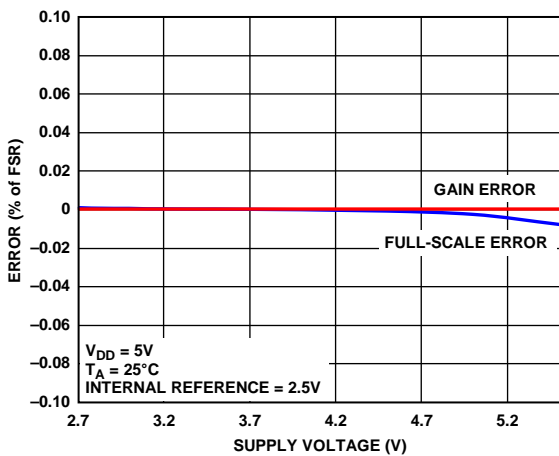

Figure 19. Gain Error and Full-Scale Error vs. Supply Voltage

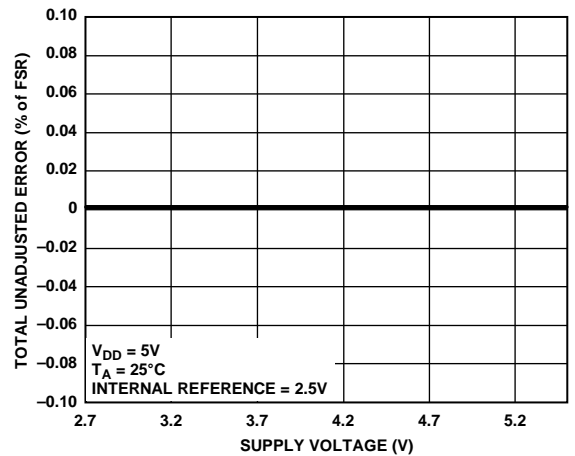

Figure 22. Total Unadjusted Error vs. Supply Voltage, Gain = 1

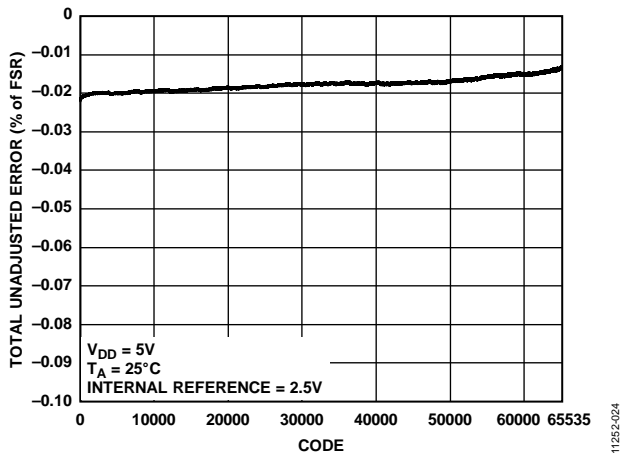

Figure 23. Total Unadjusted Error vs. Code

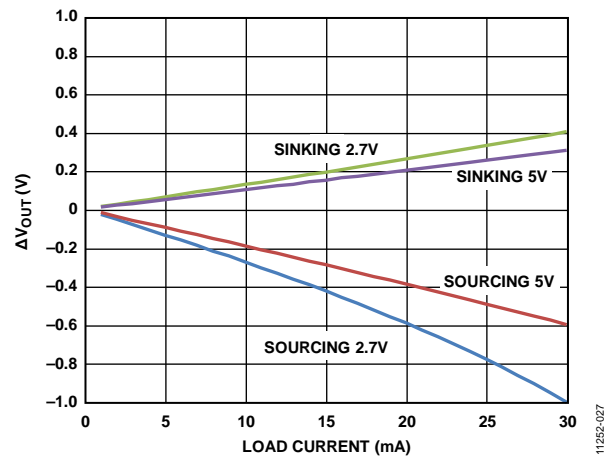

Figure 26. Headroom/Footroom vs. Load Current

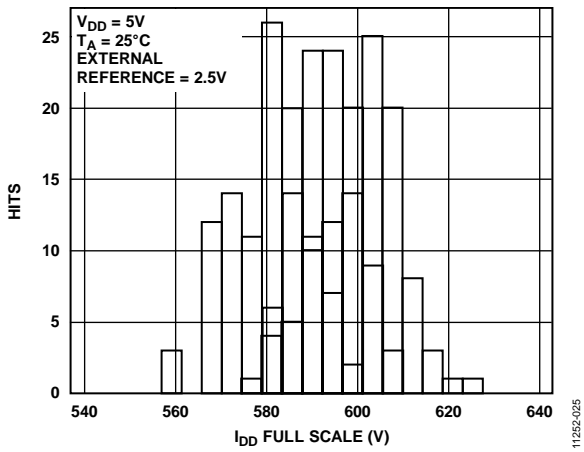

Figure 24. I_{DD} Histogram with External Reference

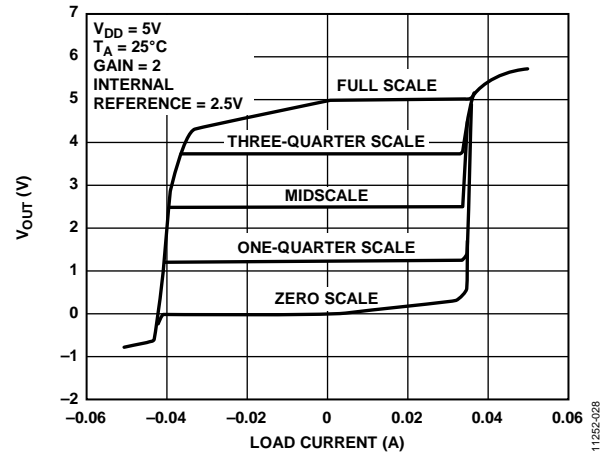

Figure 27. Source and Sink Capability at $V_{DD} = 5V$

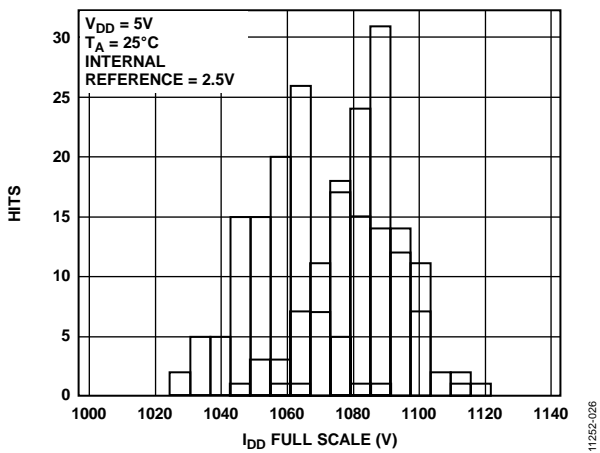

Figure 25. I_{DD} Histogram with Internal Reference, $V_{REFOUT} = 2.5V$, Gain = 2

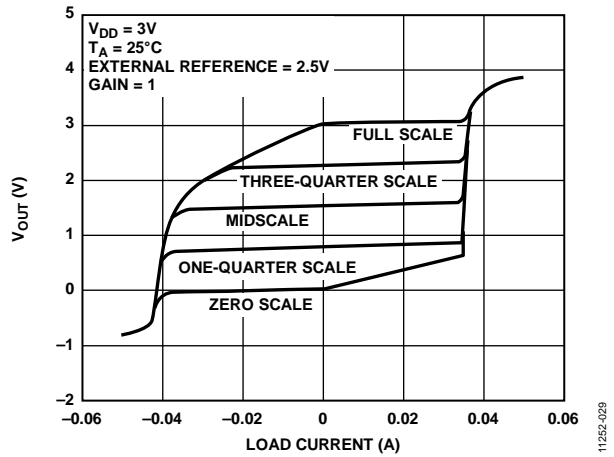

Figure 28. Source and Sink Capability at $V_{DD} = 3V$

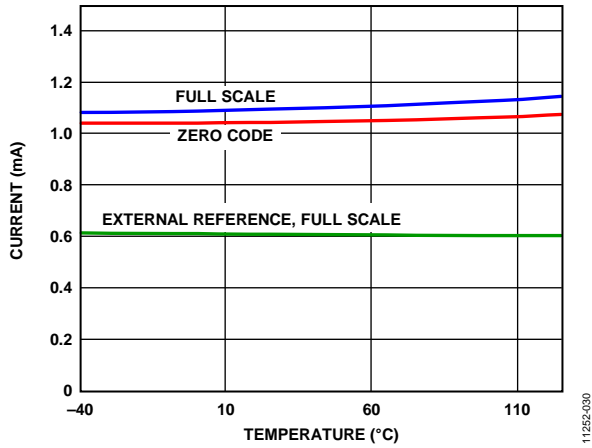

Figure 29. Supply Current vs. Temperature

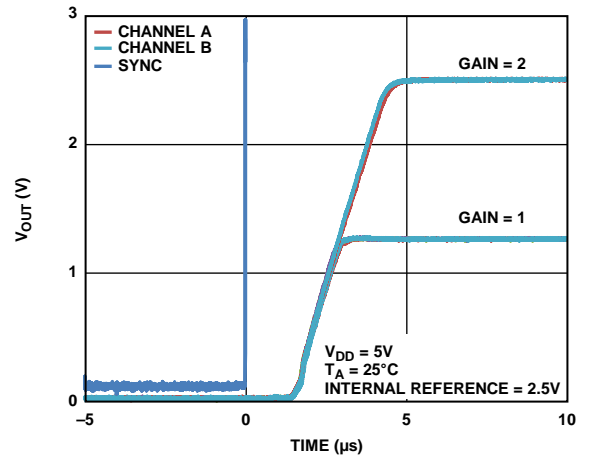

Figure 32. Exiting Power-Down to Midscale

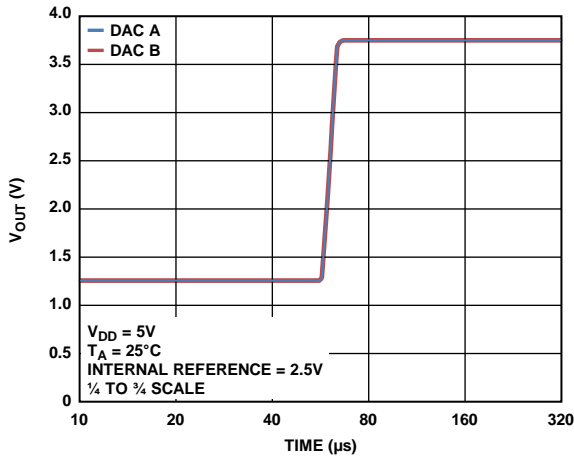

Figure 30. Settling Time

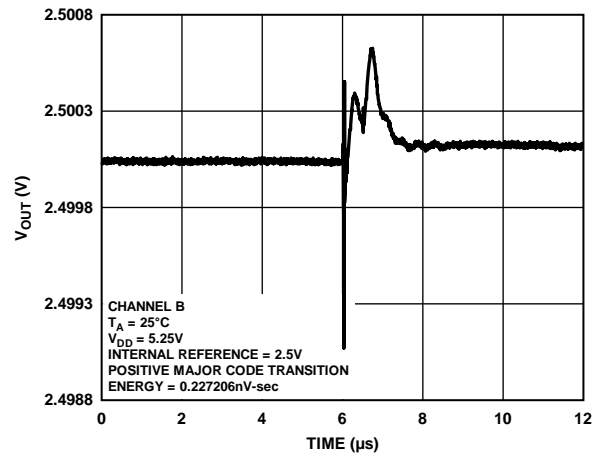

Figure 33. Digital-to-Analog Glitch Impulse

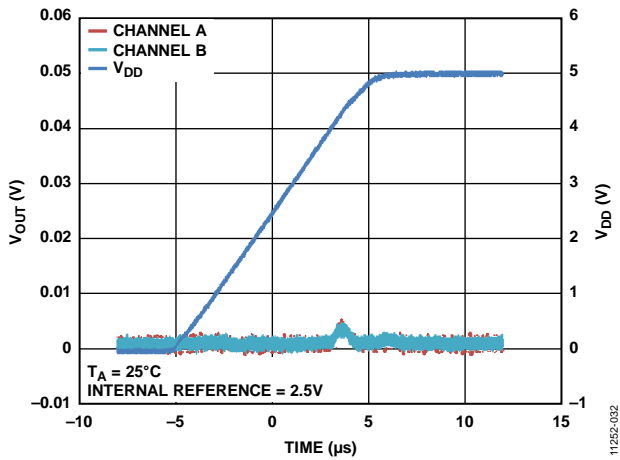

Figure 31. Power-On Reset to 0V

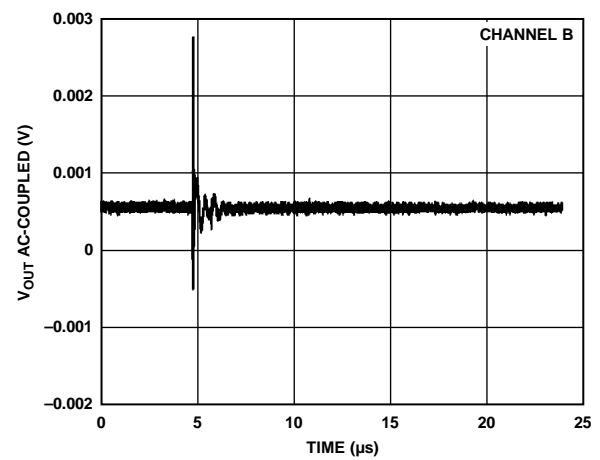

Figure 34. Analog Crosstalk, Channel A

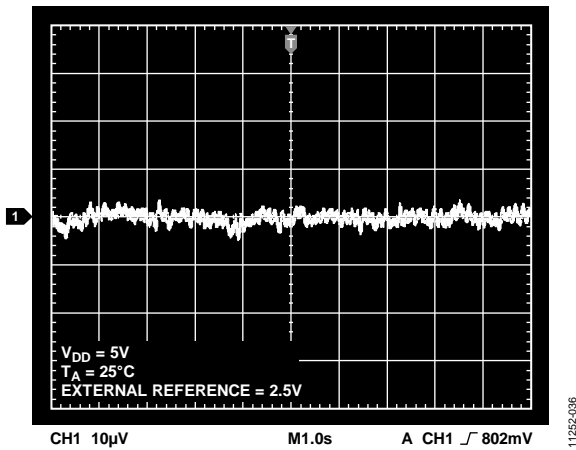

Figure 35. 0.1 Hz to 10 Hz Output Noise Plot, External Reference

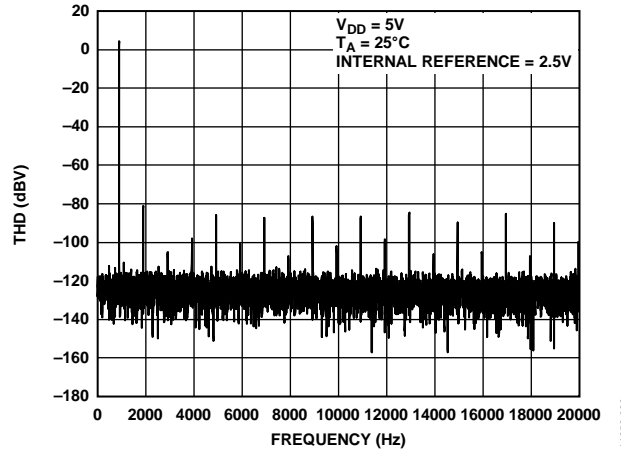

Figure 38. Total Harmonic Distortion at 1 kHz

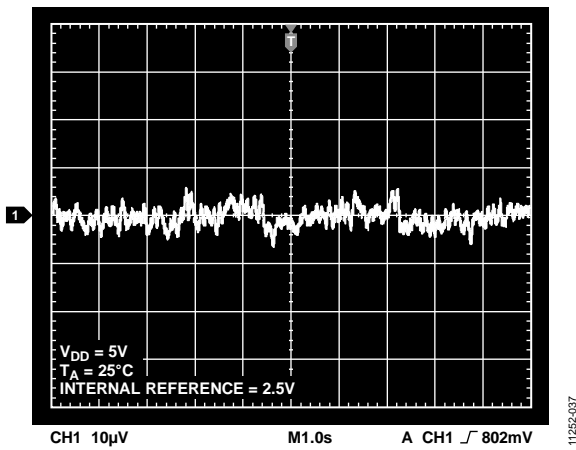

Figure 36. 0.1 Hz to 10 Hz Output Noise Plot, 2.5 V Internal Reference

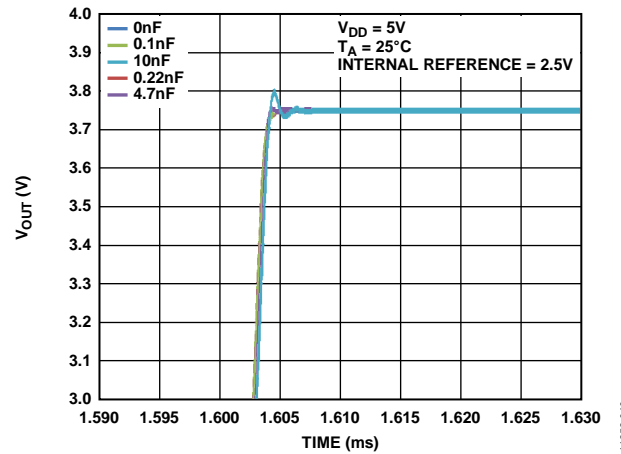

Figure 39. Settling Time vs. Capacitive Load

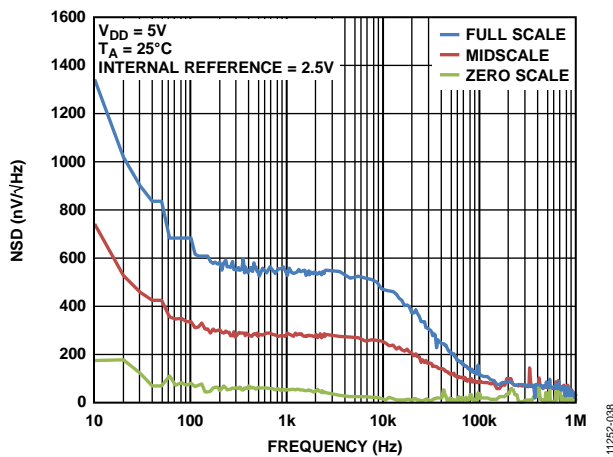

Figure 37. Noise Spectral Density

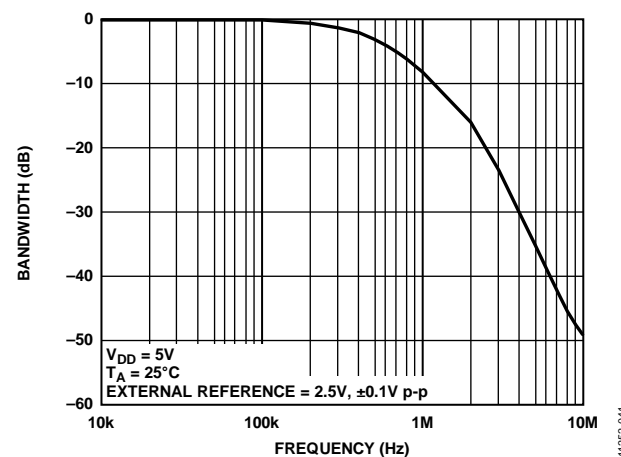

Figure 40. Multiplying Bandwidth, External Reference = 2.5 V, ±0.1 V p-p, 10 kHz to 10 MHz

TERMINOLOGY

Relative Accuracy or Integral Nonlinearity (INL)

For the DAC, relative accuracy or integral nonlinearity is a measurement of the maximum deviation, in LSBs, from a straight line passing through the endpoints of the DAC transfer function. A typical INL vs. code plot is shown in Figure 12.

Differential Nonlinearity (DNL)

Differential nonlinearity is the difference between the measured change and the ideal 1 LSB change between any two adjacent codes. A specified differential nonlinearity of ± 1 LSB maximum ensures monotonicity. This DAC is guaranteed monotonic by design. A typical DNL vs. code plot can be seen in Figure 13.

Zero-Code Error

Zero-code error is a measurement of the output error when zero code (0x0000) is loaded to the DAC register. Ideally, the output should be 0 V. The zero-code error is always positive in the AD5338R because the output of the DAC cannot go less than 0 V due to a combination of the offset errors in the DAC and the output amplifier. Zero-code error is expressed in mV. A plot of the zero-code error vs. the temperature can be seen in Figure 18.

Full-Scale Error

Full-scale error is a measurement of the output error when full-scale code is loaded to the DAC register. Ideally, the output should be $V_{DD} - 1$ LSB. Full-scale error is expressed in percent of full-scale range (% of FSR). A plot of the full-scale error vs. the temperature can be seen in Figure 17.

Gain Error

This is a measure of the span error of the DAC. It is the deviation in slope of the DAC transfer characteristic from the ideal expressed as % of FSR.

Offset Error Drift

This is a measurement of the change in offset error with a change in temperature. It is expressed in $\mu\text{V}/^\circ\text{C}$.

Gain Temperature Coefficient

This is a measurement of the change in gain error with changes in temperature. It is expressed in ppm of FSR/ $^\circ\text{C}$.

Offset Error

Offset error is a measure of the difference between V_{OUT} (actual) and V_{OUT} (ideal) expressed in mV in the linear region of the transfer function. Offset error is measured on the AD5338R with Code 8 loaded in the DAC register. It can be negative or positive.

DC Power Supply Rejection Ratio (PSRR)

This indicates how the output of the DAC is affected by changes in the supply voltage. PSRR is the ratio of the change in V_{OUT} to a change in V_{DD} for full-scale output of the DAC. It is measured in mV/V . V_{REF} is held at 2 V, and V_{DD} is varied by $\pm 10\%$.

Output Voltage Settling Time

Output voltage settling time is the time it takes for the output of a DAC to settle to a specified level for a $\frac{1}{4}$ to $\frac{3}{4}$ full-scale input change.

Digital-to-Analog Glitch Impulse

Digital-to-analog glitch impulse is the impulse injected into the analog output when the input code in the DAC register changes state. It is normally specified as the area of the glitch in nV-sec, and is measured when the digital input code is changed by 1 LSB at the major carry transition, 0x7FFF to 0x8000, (see Figure 33).

Digital Feedthrough

Digital feedthrough is a measure of the impulse injected into the analog output of the DAC from the digital inputs of the DAC, but is measured when the DAC output is not updated. It is specified in nV-sec, and measured with a full-scale code change on the data bus, that is, from all 0s to all 1s and vice versa.

Reference Feedthrough

Reference feedthrough is the ratio of the amplitude of the signal at the DAC output to the reference input when the DAC output is not being updated. It is expressed in dB.

Noise Spectral Density

This is a measurement of the internally generated random noise. Random noise is characterized as a spectral density ($\text{nV}/\sqrt{\text{Hz}}$). It is measured by loading the DAC to midscale and measuring noise at the output. It is measured in $\text{nV}/\sqrt{\text{Hz}}$. A plot of noise spectral density is shown in Figure 37.

DC Crosstalk

DC crosstalk is the dc change in the output level of one DAC in response to a change in the output of another DAC. It is measured with a full-scale output change on one DAC (or soft power-down and power-up) while monitoring another DAC kept at midscale. It is expressed in μV .

DC crosstalk due to load current change is a measure of the impact that a change in load current on one DAC has to another DAC kept at midscale. It is expressed in $\mu\text{V}/\text{mA}$.

Digital Crosstalk

This is the glitch impulse transferred to the output of one DAC at midscale in response to a full-scale code change (all 0s to all 1s and vice versa) in the input register of another DAC. It is measured in standalone mode and is expressed in nV-sec.

Analog Crosstalk

This is the glitch impulse transferred to the output of one DAC due to a change in the output of another DAC. It is measured by loading one of the input registers with a full-scale code change (all 0s to all 1s and vice versa). Then execute a software LDAC and monitor the output of the DAC whose digital code was not changed. The area of the glitch is expressed in nV-sec.

DAC-to-DAC Crosstalk

This is the glitch impulse transferred to the output of one DAC due to a digital code change and subsequent analog output change of another DAC. It is measured by loading the attack channel with a full-scale code change (all 0s to all 1s and vice versa), using the write to and update commands while monitoring the output of the victim channel that is at midscale. The energy of the glitch is expressed in nV-sec.

Multiplying Bandwidth

The amplifiers within the DAC have a finite bandwidth. The multiplying bandwidth is a measure of this. A sine wave on the reference (with full-scale code loaded to the DAC) appears on the output. The multiplying bandwidth is the frequency at which the output amplitude falls to 3 dB below the input.

Total Harmonic Distortion (THD)

THD is the difference between an ideal sine wave and its attenuated version using the DAC. The sine wave is used as the reference for the DAC, and the THD is a measurement of the harmonics present on the DAC output. It is measured in dB.

Voltage Reference Temperature Coefficient (TC)

Voltage reference TC is a measure of the change in the reference output voltage with a change in temperature. The reference TC is calculated using the box method, which defines the TC as the maximum change in the reference output over a given temperature range expressed in ppm/°C as follows;

$$TC = \left[\frac{V_{REFmax} - V_{REFmin}}{V_{REFnom} \times TempRange} \right] \times 10^6$$

where:

V_{REFmax} is the maximum reference output measured over the total temperature range.

V_{REFmin} is the minimum reference output measured over the total temperature range.

V_{REFnom} is the nominal reference output voltage, 2.5 V.

$TempRange$ is the specified temperature range of -40°C to +105°C.

THEORY OF OPERATION

DIGITAL-TO-ANALOG CONVERTER

The AD5338R is a dual, 10-bit, serial input, voltage output DAC with an internal reference. The part operates from supply voltages of 2.7 V to 5.5 V. Data is written to the AD5338R in a 24-bit word format via a 2-wire serial interface. The AD5338R incorporates a power-on reset circuit to ensure that the DAC output powers up to a known output state. The device also has a software power-down mode that reduces the typical current consumption to 4 μ A.

TRANSFER FUNCTION

The internal reference is on by default. To use an external reference, only a nonreference option is available. Because the input coding to the DAC is straight binary, the ideal output voltage when using an external reference is given by

$$V_{OUT} = V_{REF} \times Gain \left[\frac{D}{2^N} \right]$$

where:

Gain is the gain of the output amplifier and is set to 1 by default. This can be set to $\times 1$ or $\times 2$ using the gain select pin. When this pin is tied to GND, both DAC outputs have a span from 0 V to V_{REF} . If this pin is tied to V_{LOGIC} , both DACs output a span of 0 V to $2 \times V_{REF}$.

D is the decimal equivalent of the binary code that is loaded to the DAC register as 0 to 1,023 for the 10-bit device.

N is the DAC resolution.

DAC ARCHITECTURE

The DAC architecture consists of a string DAC followed by an output amplifier. Figure 41 shows a block diagram of the DAC architecture.

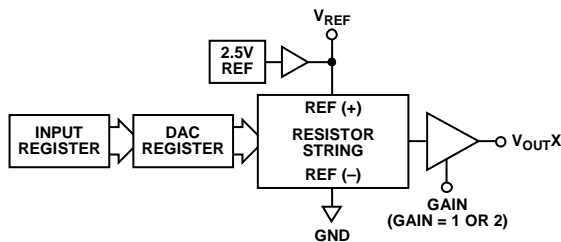

Figure 41. Single DAC Channel Architecture Block Diagram

The resistor string structure is shown in Figure 42. It is a string of resistors, each of Value R. The code loaded to the DAC register determines the node on the string where the voltage is to be tapped off and fed into the output amplifier. The voltage is tapped off by closing one of the switches connecting the string to the amplifier. Because it is a string of resistors, it is guaranteed monotonic.

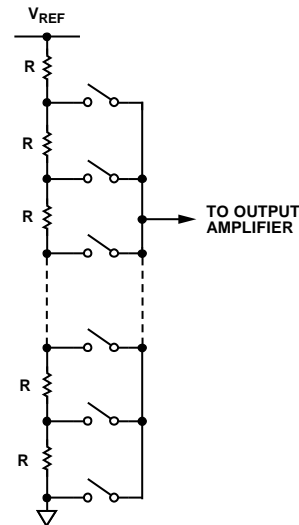

Figure 42. Resistor String Structure

Internal Reference

The AD5338R on-chip reference is on at power-up but can be disabled via a write to a control register. See the Internal Reference Setup section for details.

The AD5338R has a 2.5 V, 2 ppm/ $^{\circ}$ C reference, giving a full-scale output of 2.5 V or 5 V depending on the state of the GAIN pin. The internal reference associated with the device is available at the V_{REF} pin. This buffered reference is capable of driving external loads of up to 10 mA.

Output Amplifiers

The output buffer amplifier can generate rail-to-rail voltages on its output, which gives an output range of 0 V to V_{DD} . The actual range depends on the value of V_{REF} , the GAIN pin, the offset error, and the gain error. The GAIN pin selects the gain of the output.

- If GAIN is tied to GND, both outputs have a gain of 1, and the output range is 0 V to V_{REF} .
- If GAIN is tied to V_{LOGIC} , both outputs have a gain of 2, and the output range is 0 V to $2 \times V_{REF}$.

These amplifiers are capable of driving a load of 1 k Ω in parallel with 2 nF to GND. The slew rate is 0.8 V/ μ s with a $\frac{1}{4}$ to $\frac{3}{4}$ scale settling time of 5 μ s.

SERIAL INTERFACE

The AD5338R has a 2-wire I²C-compatible serial interface (refer to *I²C-Bus Specification*, Version 2.1, January 2000, available from Philips Semiconductor). See Figure 2 for a timing diagram of a typical write sequence. The AD5338R can be connected to an I²C bus as a slave device, under the control of a master device. The AD5338R can support standard (100 kHz) and fast (400 kHz) data transfer modes. Support is not provided for 10-bit addressing and general call addressing.

Input Shift Register

The input shift register of the AD5338R is 24 bits wide. Data is loaded into the device as a 24-bit word under the control of a serial clock input, SCL. The first eight MSBs make up the command byte. The first four bits are the command bits (C3, C2, C1, and C0) that control the mode of operation of the device (see Table 7). The last four bits of the first byte are the address bits (DAC B, 0, 0, and DAC A, see Table 8).

The data-word comprises 10-bit input code, followed by six don't care bits for the AD5338R. These data bits are transferred to the input register on the 24 falling edges of SCL.

Commands can be executed on the individual DAC channels or on both DACs, depending on the address bits selected.

Table 7. Command Definitions

Command				Description
C3	C2	C1	C0	
0	0	0	0	No operation
0	0	0	1	Write to Input Register n (dependent on $\overline{\text{LDAC}}$)
0	0	1	0	Update DAC Register n with contents of Input Register n
0	0	1	1	Write to and update DAC Channel n
0	1	0	0	Power down/power up DAC
0	1	0	1	Hardware $\overline{\text{LDAC}}$ mask register
0	1	1	0	Software reset (power-on reset)
0	1	1	1	Internal reference setup register
1	0	0	0	Reserved
...	Reserved
1	1	1	1	Reserved

Table 8. Address Commands

Selected DAC Channel				
DAC B	DB18	DB17	DAC A	Description
0	0	0	1	DAC A
1	0	0	0	DAC B
1	0	0	1	DAC A and DAC B

WRITE AND UPDATE COMMANDS

Write to Input Register n (Dependent on $\overline{\text{LDAC}}$)

Command 0001 allows the user to write to the dedicated input register of each DAC individually. When $\overline{\text{LDAC}}$ is low, the input register is transparent (if not controlled by the LDAC mask register).

Update DAC Register n with Contents of Input Register n

Command 0010 loads the DAC registers/outputs with the contents of the input registers selected and updates the DAC outputs directly.

Write to and Update DAC Channel n (Independent of $\overline{\text{LDAC}}$)

Command 0011 allows the user to write to the DAC registers and update the DAC outputs directly.

DB23	DB22	DB21	DB20	DB19	DB18	DB17	DB16	DB15	DB14	DB13	DB12	DB11	DB10	DB9	DB8	DB7	DB6	DB5	DB4	DB3	DB2	DB1	DB0
C3	C2	C1	C0	DAC B	0	0	DAC A	D9	D8	D7	D6	D5	D4	D3	D2	D1	D0	X	X	X	X	X	X
COMMAND				DAC ADDRESS				DAC DATA								DAC DATA							
COMMAND BYTE								DATA HIGH BYTE								DATA LOW BYTE							

Figure 43. Input Shift Register Content

11252-044

SERIAL OPERATION

The AD5338R has a 7-bit slave address. The five MSBs are 00011 and the two LSBs (A1 and A0) are set by the state of the A0 and A1 address pins. The ability to make hardwired changes to A0 and A1 allows the user to incorporate up to four of these devices on one bus, as outlined in Table 9.

Table 9. Device Address Selection

A0 Pin Connection	A1 Pin Connection	A0	A1
GND	GND	0	0
V _{LOGIC}	GND	1	0
GND	V _{LOGIC}	0	1
V _{LOGIC}	V _{LOGIC}	1	1

The 2-wire serial bus protocol operates as follows:

1. The master initiates data transfer by establishing a start condition when a high-to-low transition on the SDA line occurs while SCL is high. The following byte is the address byte, which consists of the 7-bit slave address. The slave address corresponding to the transmitted address responds by pulling SDA low during the 9th clock pulse (this is termed the acknowledge bit). At this stage, all other devices on the bus remain idle while the selected device waits for data to be written to, or read from, its shift register.

2. Data is transmitted over the serial bus in sequences of nine clock pulses (eight data bits followed by an acknowledge bit). The transitions on the SDA line must occur during the low period of SCL and remain stable during the high period of SCL.
3. When all data bits have been read or written, a stop condition is established. In write mode, the master pulls the SDA line high during the 10th clock pulse to establish a stop condition. In read mode, the master issues a no acknowledge for the 9th clock pulse (that is, the SDA line remains high). The master then brings the SDA line low before the 10th clock pulse, and then high during the 10th clock pulse to establish a stop condition.

WRITE OPERATION

When writing to the AD5338R, the user must begin with a start command followed by an address byte (R/W = 0), after which the DAC acknowledges that it is prepared to receive data by pulling SDA low. The AD5338R requires two bytes of data for the DAC and a command byte that controls various DAC functions. Three bytes of data must, therefore, be written to the DAC with the command byte followed by the most significant data byte and the least significant data byte, as shown in Figure 44. All these data bytes are acknowledged by the AD5338R. A stop condition follows.

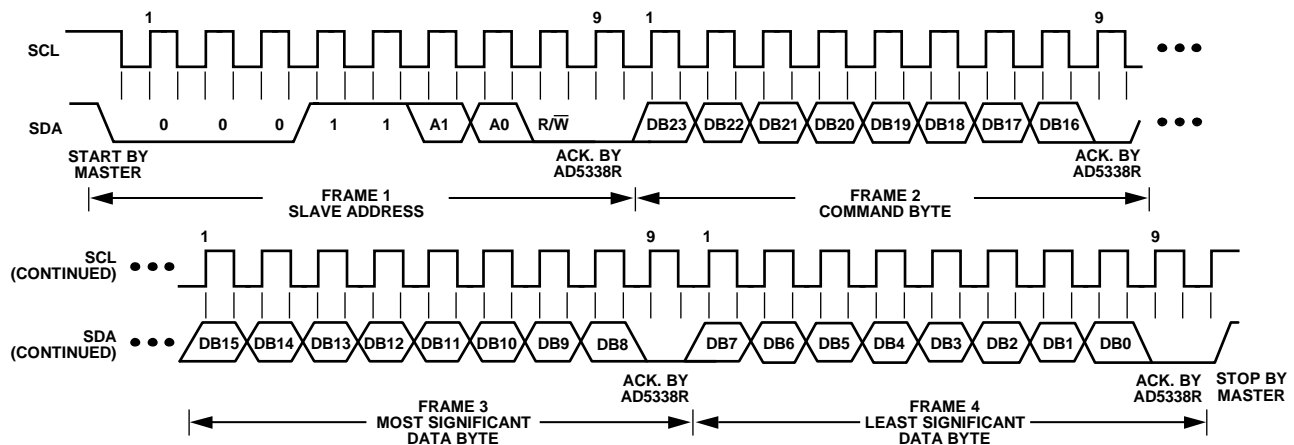

Figure 44. I²C Write Operation

11252-045

READ OPERATION

When reading data back from the AD5338R DACs, the user begins with an address byte ($R/\overline{W} = 0$), after which the DAC acknowledges that it is prepared to receive data by pulling SDA low. This address byte must be followed by the control byte that determines both the read command that is to follow and the pointer address to read from, which is also acknowledged by the DAC. The user configures which channel to read back and sets the readback command to active using the control byte. Following this, there is a repeated start condition by the master and the address is resent with $R/\overline{W} = 1$. This is acknowledged by the DAC, indicating that it is prepared to transmit data. Two bytes of data are then read from the DAC, as shown in Figure 45. A NACK condition from the master, followed by a STOP condition, completes the read sequence. Default readback is Channel A if both DACs are selected.

MULTIPLE DAC READBACK SEQUENCE

The user begins with an address byte ($R/\overline{W} = 0$), after which the DAC acknowledges that it is prepared to receive data by pulling SDA low. This address byte must be followed by the control byte, which is also acknowledged by the DAC. The user configures which channel to start the readback using the control byte. Following this, there is a repeated start condition by the master, and the address is resent with $R/\overline{W} = 1$. This is acknowledged by the DAC, indicating that it is prepared to transmit data. The first two bytes of data are then read from DAC Input Register A that is selected using the control byte, most significant byte first, as shown in Figure 45. The next four bytes read back are don't care bytes, and the next two bytes of data are the contents of DAC Input Register B. Data continues to be read from the DAC input registers in this auto-incremental fashion, until a NACK followed by a stop condition follows. If the contents of DAC Input Register B are read out, the next bytes of data that are read are from the contents of DAC Input Register A.

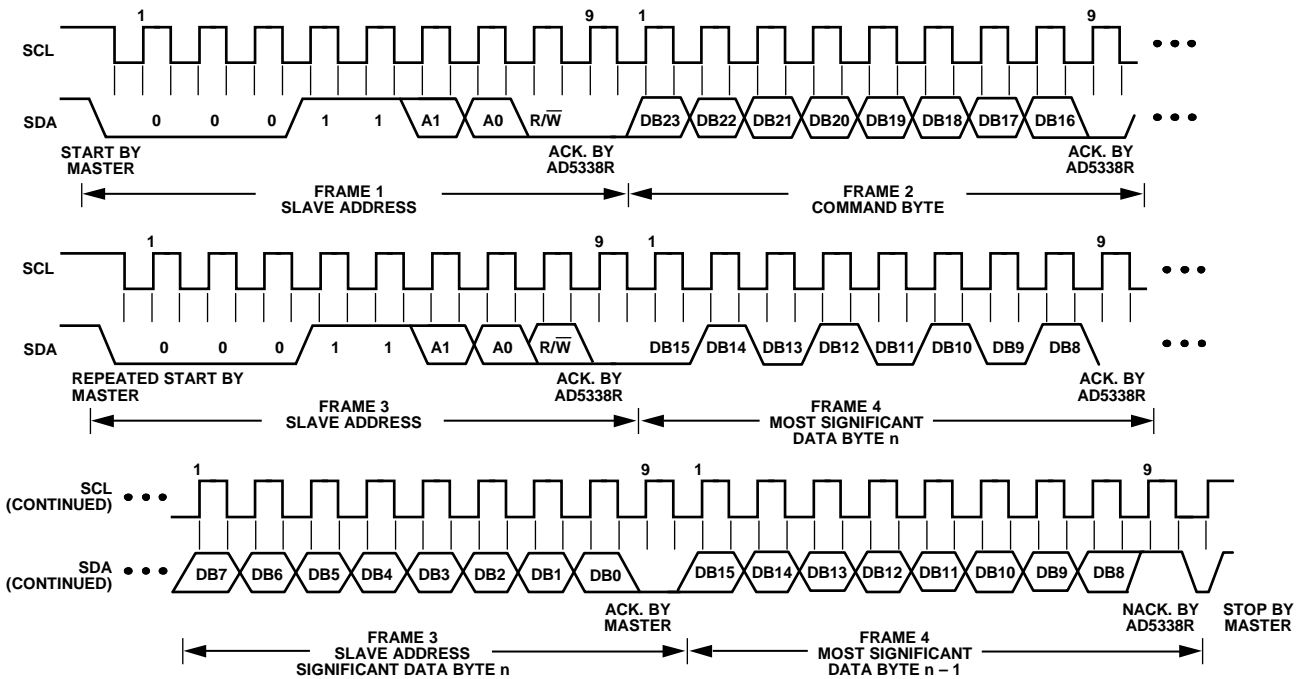

Figure 45. I²C Read Operation

11252-046

POWER-DOWN OPERATION

The AD5338R contains three separate power-down modes. Command 0100 is designated for the power-down function (see Table 7). These power-down modes are software programmable by setting eight bits, Bit DB7 to Bit DB0, in the shift register. There are two bits associated with each DAC channel. Table 10 shows how the state of the two bits corresponds to the mode of operation of the device.

Table 10. Modes of Operation

Operating Mode	PDx1	PDx0
Normal Operation	0	0
Power-Down Modes		
1 kΩ to GND	0	1
100 kΩ to GND	1	0
Three-State	1	1

Either or both DACs (DAC A and DAC B) can be powered down to the selected mode by setting the corresponding bits. See Table 11 for the contents of the input shift register during the power-down/ power-up operation.

When both Bit PDx1 and Bit PDx0 (where x is the channel selected) in the input shift register are set to 0, the part works normally with its normal power consumption of 4 mA at 5 V. However, for the three power-down modes, the supply current falls to 4 μA at 5 V. Not only does the supply current fall, but also the output stage is also internally switched from the output of

the amplifier to a resistor network of known values. This has the advantage that the output impedance of the part is known while the part is in power-down mode. There are three different power-down options. The output is connected internally to GND through either a 1 kΩ or a 100 kΩ resistor, or it is left open-circuited (three-state). The output stage is illustrated in Figure 46.

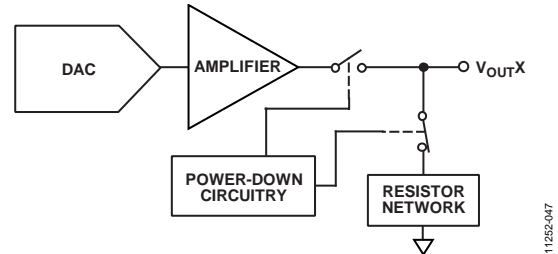

Figure 46. Output Stage During Power-Down

The bias generator, output amplifier, resistor string, and other associated linear circuitry are shut down when the power-down mode is activated. However, the contents of the DAC register are unaffected when in power-down. The DAC register can be updated while the device is in power-down mode. The time required to exit power-down is typically 4.5 μs for V_{DD} = 5 V.

To reduce the current consumption further, the on-chip reference can be powered off. See the Internal Reference Setup section.

Table 11. 24-Bit Input Shift Register Contents of Power-Down/Power-Up Operation¹

DB23 (MSB)	DB22	DB21	DB20	DB19 to DB16	DB15 to DB8	DB7	DB6	DB5	DB4	DB3	DB2	DB1	DB0 (LSB)
0	1	0	0	X	X	PDB1	PDB0	1	1	1	1	PDA1	PDA0
Command bits (C3 to C0)				Address bits, don't care			Power-Down, select DAC B						Power-Down, select DAC A

¹ X = don't care.

LOAD DAC (HARDWARE $\overline{\text{LDAC}}$ PIN)

The AD5338R DACs have double buffered interfaces consisting of two banks of registers: input registers and DAC registers. The user can write to any combination of the input registers. Updates to the DAC register are controlled by the $\overline{\text{LDAC}}$ pin.

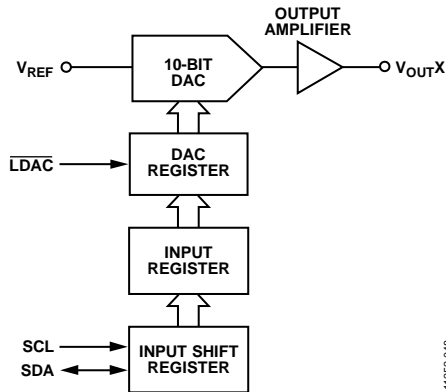

Figure 47. Simplified Diagram of Input Loading Circuitry for a Single DAC

Instantaneous DAC Updating ($\overline{\text{LDAC}}$ Held Low)

$\overline{\text{LDAC}}$ is held low while data is clocked into the input register using Command 0001. Both the addressed input register and the DAC register are updated on the 24th clock, and the output begins to change (see Table 14).

Deferred DAC Updating ($\overline{\text{LDAC}}$ is Pulsed Low)

$\overline{\text{LDAC}}$ is held high while data is clocked into the input register using Command 0001. Both DAC outputs are asynchronously updated by taking $\overline{\text{LDAC}}$ low after the 24th clock. The update now occurs on the falling edge of $\overline{\text{LDAC}}$.

Table 13. 24-Bit Input Shift Register Contents for $\overline{\text{LDAC}}$ Operation¹

DB23 (MSB)	DB22	DB21	DB20	DB19	DB18	DB17	DB16	DBB15 to DB4	DB3	DB2	DB1	DB0 (LSB)
0	0	0	1	X	X	X	X	X	DAC B	0	0	DAC A
Command bits (C3 to C0)				Address bits, don't care				Don't care	Setting $\overline{\text{LDAC}}$ to 1 overrides the $\overline{\text{LDAC}}$ pin			

¹ X = don't care.

Table 14. Write Commands and $\overline{\text{LDAC}}$ Pin Truth Table¹

Command	Description	Hardware $\overline{\text{LDAC}}$ Pin State	Input Register Contents	DAC Register Contents
0001	Write to Input Register n (dependent on $\overline{\text{LDAC}}$)	V _{LOGIC}	Data update	No change (no update)
		GND ²	Data update	Data update
0010	Update DAC Register n with contents of Input Register n	V _{LOGIC}	No change	Updated with input register contents
		GND	No change	Updated with input register contents
0011	Write to and update DAC Channel n	V _{LOGIC}	Data update	Data update
		GND	Data update	Data update

¹ A high-to-low hardware $\overline{\text{LDAC}}$ pin transition always updates the contents of the DAC register with the contents of the input register on channels that are not masked (blocked) by the $\overline{\text{LDAC}}$ mask register.

² When the $\overline{\text{LDAC}}$ pin is permanently tied low, the $\overline{\text{LDAC}}$ mask bits are ignored.

$\overline{\text{LDAC}}$ MASK REGISTER

Command 0101 is reserved for this software $\overline{\text{LDAC}}$ mask function, which allows the address bits to be ignored. Writing to the DAC using Command 0101, loads the 4-bit $\overline{\text{LDAC}}$ register (DB3 to DB0). The default for each channel is 0; that is, the $\overline{\text{LDAC}}$ pin works normally. Setting the bits to 1 forces this DAC channel to ignore transitions on the $\overline{\text{LDAC}}$ pin, regardless of the state of the hardware $\overline{\text{LDAC}}$ pin. This flexibility is useful in applications where the user wishes to select which channels respond to the $\overline{\text{LDAC}}$ pin.

Table 12. $\overline{\text{LDAC}}$ Overwrite Definition

Load $\overline{\text{LDAC}}$ Register		$\overline{\text{LDAC}}$ Operation
$\overline{\text{LDAC}}$ Bits (DB3 or DB0)	$\overline{\text{LDAC}}$ Pin	
0	1 or 0	Determined by the $\overline{\text{LDAC}}$ pin.
1	X ¹	DAC channels update and override the $\overline{\text{LDAC}}$ pin. DAC channels see $\overline{\text{LDAC}}$ pin as 1.

¹ X = don't care.

The $\overline{\text{LDAC}}$ register gives the user extra flexibility and control over the hardware $\overline{\text{LDAC}}$ pin (see Table 12). Setting the $\overline{\text{LDAC}}$ bits (DB0 or DB3) to 0 for a DAC channel means that the update of the channel is controlled by the hardware $\overline{\text{LDAC}}$ pin.

HARDWARE RESET ($\overline{\text{RESET}}$)

$\overline{\text{RESET}}$ is an active low reset that allows the outputs to be cleared to either zero scale or midscale. The clear code value is user selectable via the power-on reset select (RSTSEL) pin. It is necessary to keep $\overline{\text{RESET}}$ low for a minimum amount of time to complete the operation. When the $\overline{\text{RESET}}$ signal is returned high, the output remains at the cleared value until a new value is programmed. The outputs cannot be updated with a new value while the $\overline{\text{RESET}}$ pin is low. Also, a software executable reset function can reset the DAC to the power-on reset code. Command 0110 is designated for this software reset function (see Table 7). Any events on $\overline{\text{LDAC}}$ or $\overline{\text{RESET}}$ during power-on reset are ignored.

RESET SELECT PIN (RSTSEL)

The AD5338R contains a power-on reset circuit that controls the output voltage during power-up. By connecting the RSTSEL pin low, the output powers up to zero scale. Note that this is outside the linear region of the DAC; by connecting the RSTSEL pin high, V_{OUT} powers up to midscale. The output remains powered up at this level until a valid write sequence is made to the DAC.

INTERNAL REFERENCE SETUP

Command 0111 is reserved for setting up the internal reference (see Table 7). By default, the on-chip reference is on at power-up. To reduce the supply current, this reference can be turned off by setting the software-programmable bit, DB0, as shown in Table 16. Table 15 shows how the state of the bit corresponds to the mode of operation.

Table 15. Reference Setup Register

Internal Reference Setup Register (DB0)	Action
0	Reference on (default)
1	Reference off

Table 16. 24-Bit Input Shift Register Contents for Internal Reference Setup Command¹

DB23 (MSB)	DB22	DB21	DB20	DB19	DB18	DB17	DB16	DB15 to DB1	DB0 (LSB)
0	1	1	1	X	X	X	X	X	0/1
Command bits (C3 to C0)				Address bits (A3 to A0)				Don't care	Reference setup register

¹ X = don't care.

SOLDER HEAT REFLOW

As with all IC reference voltage circuits, the reference value experiences a shift induced by the soldering process. Analog Devices, Inc., performs a reliability test called precondition to mimic the effect of soldering a device to a board. The output voltage specification quoted in Table 3 includes the effect of this reliability test.

Figure 48 shows the effect of solder heat reflow (SHR) as measured through the reliability test (precondition).

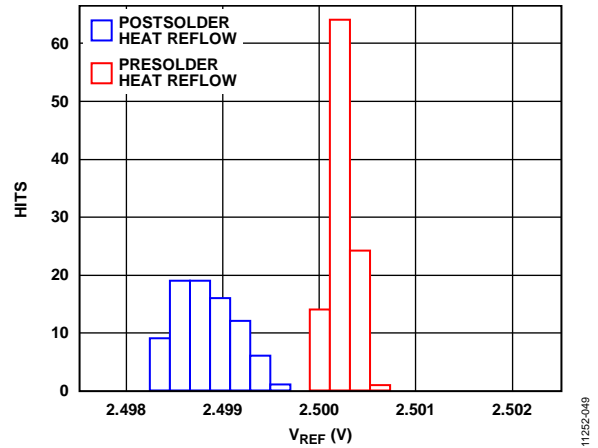

Figure 48. SHR Reference Voltage Shift

LONG-TERM TEMPERATURE DRIFT

Figure 49 shows the change in V_{REF} value after 1000 hours in life test at 150°C.

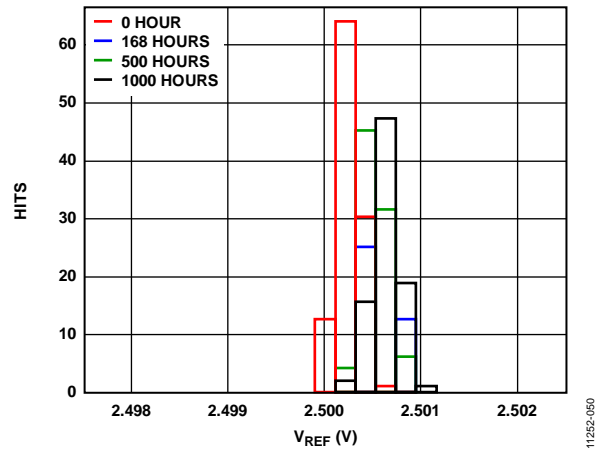

Figure 49. Reference Drift Through to 1000 Hours

THERMAL HYSTERESIS

Thermal hysteresis is the voltage difference induced on the reference voltage by sweeping the temperature from ambient to cold, to hot, and then back to ambient.

Thermal hysteresis data is shown in Figure 50. It is measured by sweeping temperature from ambient to -40°C, then to +105°C, and returning to ambient. The V_{REF} delta is then measured between the two ambient measurements and shown in blue in Figure 50. The same temperature sweep and measurements are immediately repeated, and the results are shown in red in Figure 50.

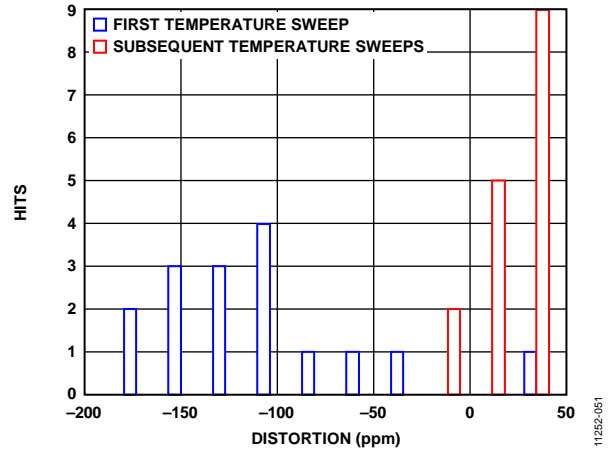

Figure 50. Thermal Hysteresis

APPLICATIONS INFORMATION

MICROPROCESSOR INTERFACING

Microprocessor interfacing to the AD5338R is via a serial bus that uses a standard protocol that is compatible with DSP processors and microcontrollers. The communications channel requires a 2-wire interface consisting of a clock signal and a data signal.

AD5338R TO ADSP-BF531 INTERFACE

The I²C interface of the AD5338R is designed to be easily connected to industry-standard DSPs and microcontrollers. Figure 51 shows the AD5338R connected to the Analog Devices Blackfin[®] DSP (ADSP-BF531). The Blackfin has an integrated I²C port that can be connected directly to the I²C pins of the AD5338R.

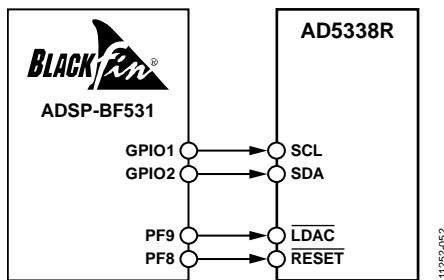

Figure 51. ADSP-BF531 Interface to the AD5338R

LAYOUT GUIDELINES

In any circuit where accuracy is important, careful consideration of the power supply and ground return layout helps to ensure the rated performance. Design the printed circuit board (PCB) on which the AD5338R is mounted so that the AD5338R lies on the analog plane.

The AD5338R must have ample supply bypassing of 10 μ F in parallel with 0.1 μ F on each supply, located as close to the package as possible, ideally right up against the device. The 10 μ F capacitor is the tantalum bead type. The 0.1 μ F capacitor must have low effective series resistance (ESR) and low effective series inductance (ESI), such as the common ceramic types that provide a low impedance path to ground at high frequencies to handle transient currents due to internal logic switching.

In systems where there are many devices on one board, it is often useful to provide some heat sinking capability to allow the power to dissipate easily.

The AD5338R LFCSP model has an exposed paddle beneath the device. Connect this paddle to the GND supply for the part. For optimum performance, use special considerations to design the motherboard and to mount the package. For enhanced thermal, electrical, and board level performance, solder the exposed paddle on the bottom of the package to the corresponding thermal land paddle on the PCB. Design thermal vias into the PCB land paddle area to further improve heat dissipation.

The GND plane on the device can be increased (as shown in Figure 52) to provide a natural heat sinking effect.

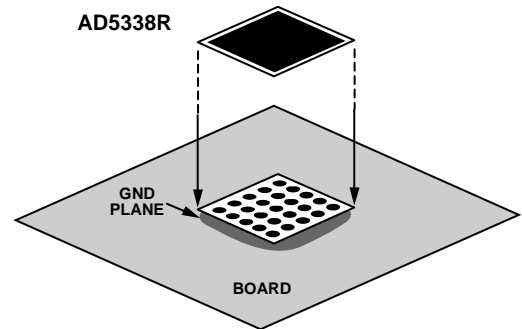
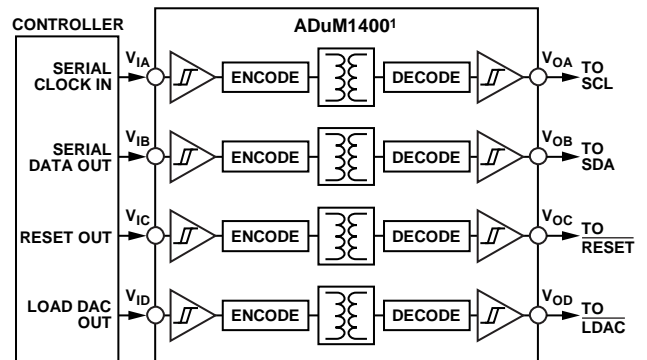

Figure 52. Paddle Connection to Board

GALVANICALLY ISOLATED INTERFACE

In many process control applications, it is necessary to provide an isolation barrier between the controller and the unit being controlled to protect and isolate the controlling circuitry from any hazardous common-mode voltages that may occur. iCoupler[®] products from Analog Devices provide voltage isolation in excess of 2.5 kV. The serial loading structure of the AD5338R makes the part ideal for isolated interfaces because the number of interface lines is kept to a minimum. Figure 53 shows a 4-channel isolated interface to the AD5338R using the ADuM1400. For further information, visit <http://www.analog.com/icouplers>.



¹ADDITIONAL PINS OMITTED FOR CLARITY.

Figure 53. Isolated Interface

OUTLINE DIMENSIONS

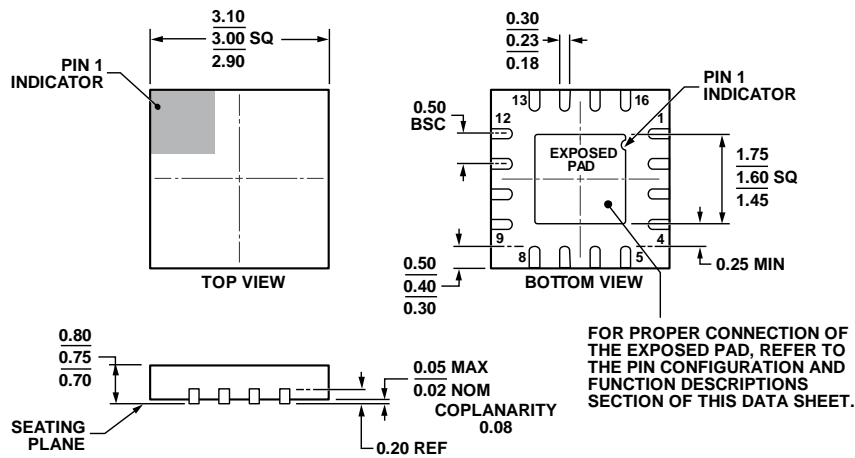

COMPLIANT TO JEDEC STANDARDS MO-220-WEED-6.

Figure 54. 16-Lead Lead Frame Chip Scale Package [LFCSP_WQ]
3 mm × 3 mm Body, Very Very Thin Quad
(CP-16-22)
Dimensions shown in millimeters

08-16-2010-E

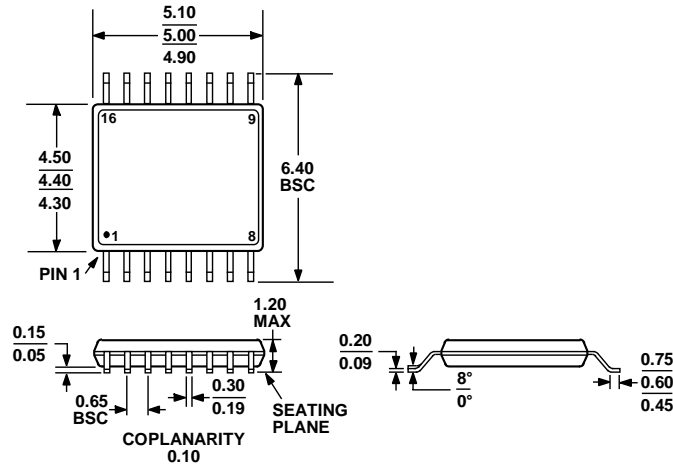

COMPLIANT TO JEDEC STANDARDS MO-153-AB

Figure 55. 16-Lead Thin Shrink Small Outline Package [TSSOP]
(RU-16)
Dimensions shown in millimeters

ORDERING GUIDE

Model ¹	Resolution	Temperature Range	Accuracy	Reference Temperature Coefficient (ppm/°C)	Package Description	Package Option	Branding
AD5338RBCPZ-RL7	10 Bits	-40°C to +105°C	±1 LSB INL	±5 (max)	16-Lead LFCSP_WQ	CP-16-22	DKX
AD5338RBRUZ	10 Bits	-40°C to +105°C	±1 LSB INL	±5 (max)	16-Lead TSSOP	RU-16	
AD5338RBRUZ-RL7	10 Bits	-40°C to +105°C	±1 LSB INL	±5 (max)	16-Lead TSSOP	RU-16	

¹ Z = RoHS Compliant Part.

NOTES

NOTES