

Bulletin PD-20743 rev. A 07/01

International IOR Rectifier

208CNQ060

SCHOTTKY RECTIFIER

200 Amp

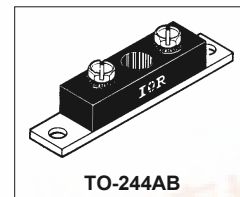

Major Ratings and Characteristics

Characteristics	208CNQ...	Units
$I_{F(AV)}$ Rectangular waveform	200	A
V_{RRM} range	60	V
I_{FSM} @tp = 5 μ s sine	16,000	A
V_F @100Apk, $T_J = 125^\circ\text{C}$ (per leg)	0.59	V
T_J range	-55 to 150	$^\circ\text{C}$

Description/Features

The 208CNQ center tap Schottky rectifier module series has been optimized for low reverse leakage at high temperature. The proprietary barrier technology allows for reliable operation up to 150 $^\circ\text{C}$ junction temperature. Typical applications are in high current switching power supplies, plating power supplies, UPS systems, converters, free-wheeling diodes, welding, and reverse battery protection.

- 150 $^\circ\text{C}$ T_J operation
- Center tap module
- High purity, high temperature epoxy encapsulation for enhanced mechanical strength and moisture resistance
- Low forward voltage drop
- High frequency operation
- Guard ring for enhanced ruggedness and long term reliability

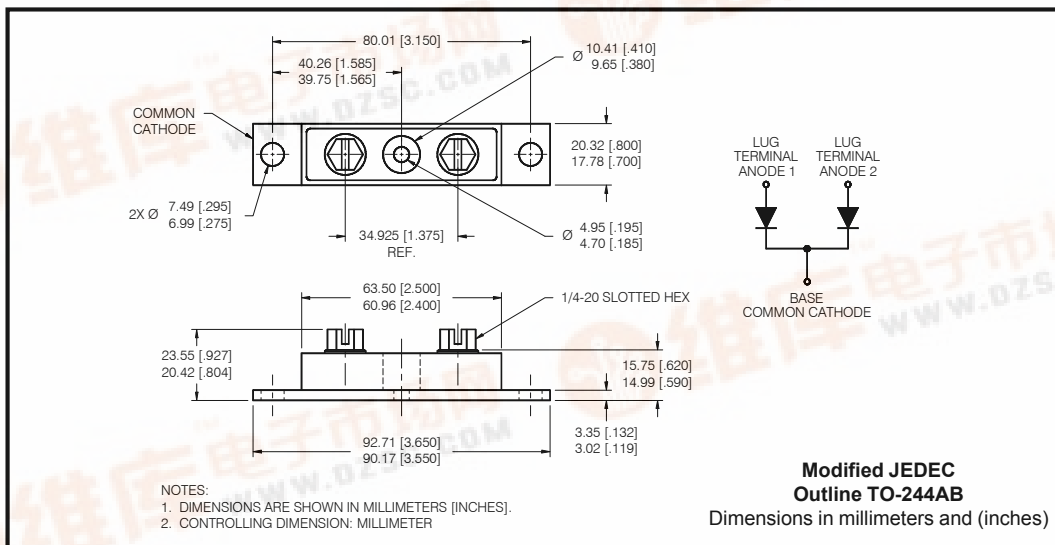

208CNQ060

Bulletin PD-20743 rev. A 07/01



Voltage Ratings

Part number	208CNQ060
V _R Max. DC Reverse Voltage (V)	60
V _{RWM} Max. Working Peak Reverse Voltage (V)	

Absolute Maximum Ratings

Parameters	208CNQ	Units	Conditions
I _{F(AV)} Max. Average Forward Current (Per Leg) * See Fig. 5 (Per Device)	100	A	50% duty cycle @ T _C = 115 °C, rectangular wave form
	200		
I _{FSM} Max. Peak One Cycle Non-Repetitive Surge Current (Per Leg) * See Fig. 7	16,000	A	5µs Sine or 3µs Rect. pulse 10ms Sine or 6ms Rect. pulse Following any rated load condition and with rated V _{RWM} applied
	2,100		
E _{AS} Non-Repetitive Avalanche Energy (Per Leg)	15	mJ	T _J = 25 °C, I _{AS} = 1 Amps, L = 30 mH
I _{AR} Repetitive Avalanche Current (Per Leg)	1	A	Current decaying linearly to zero in 1 µsec Frequency limited by T _J max. V _A = 1.5 x V _R typical

Electrical Specifications

Parameters	208CNQ	Units	Conditions
V _{FM} Max. Forward Voltage Drop (Per Leg) * See Fig. 1 (1)	0.68	V	@ 100A
	0.83	V	@ 200A
	0.59	V	@ 100A
	0.75	V	@ 200A
I _{RM} Max. Reverse Leakage Current (Per Leg) * See Fig. 2 (1)	1.1	mA	T _J = 25 °C
	300	mA	T _J = 125 °C
V _{F(TO)} Threshold Voltage	0.32	V	T _J = T _J max.
r _t Forward Slope Resistance	2.1	mΩ	
C _T Max. Junction Capacitance (Per Leg)	6000	pF	V _R = 5V _{DC} , (test signal range 100Khz to 1Mhz) 25 °C
L _S Typical Series Inductance (Per Leg)	7.0	nH	From top of terminal hole to mounting plane
dv/dt Max. Voltage Rate of Change (Rated V _R)	10000	V/ µs	

Thermal-Mechanical Specifications

(1) Pulse Width < 300µs, Duty Cycle < 2%

Parameters	208CNQ	Units	Conditions
T _J Max. Junction Temperature Range	-55 to 150	°C	
T _{stg} Max. Storage Temperature Range	-55 to 150	°C	
R _{thJC} Max. Thermal Resistance Junction to Case (Per Leg)	0.40	°C/W	DC operation * See Fig. 4
R _{thJC} Max. Thermal Resistance Junction to Case (Per Package)	0.20	°C/W	DC operation
R _{thCS} Typical Thermal Resistance, Case to Heatsink	0.10	°C/W	Mounting surface, smooth and greased
wt Approximate Weight	79 (2.80)	g (oz.)	
T Mounting Torque	Min.	24 (20)	Kg-cm (lbf-in)
	Max.	35 (30)	
	Typ.	13.5 (12)	
	Terminal Torque	Min.	
	Max.	46 (40)	
Case Style	TO-244AB		Modified JEDEC

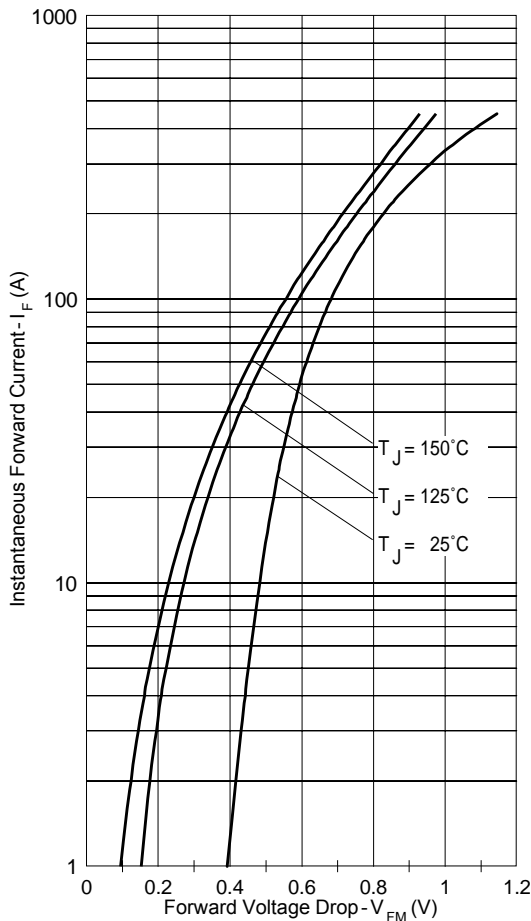

Fig. 1 - Max. Forward Voltage Drop Characteristics

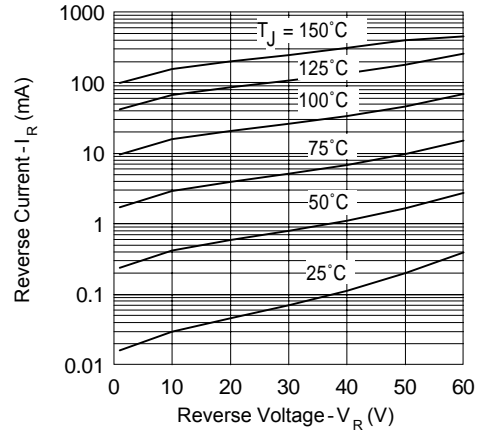

Fig. 2 - Typical Values Of Reverse Current Vs. Reverse Voltage

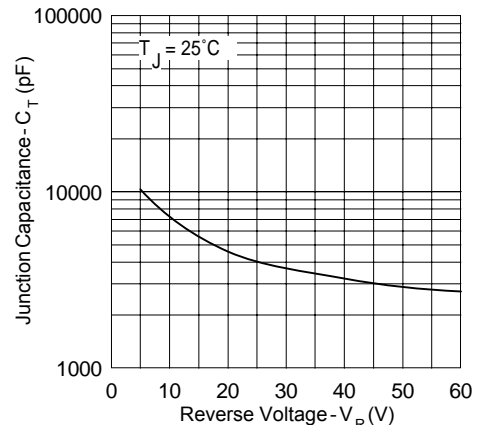

Fig. 3 - Typical Junction Capacitance Vs. Reverse Voltage

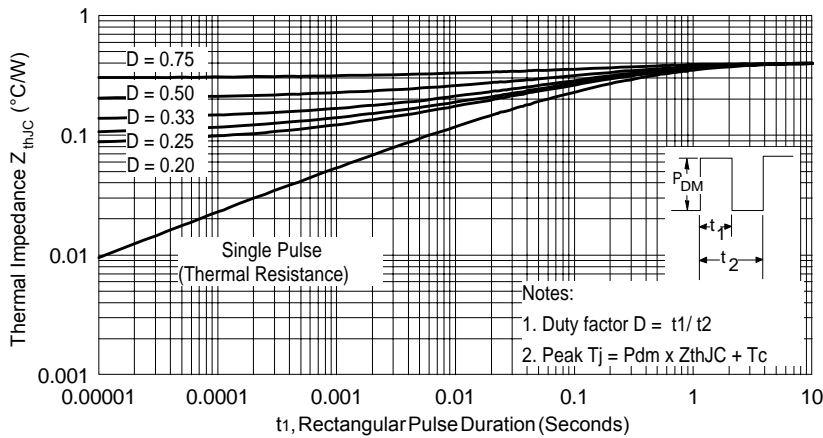

Fig. 4 - Max. Thermal Impedance Z_{thJC} Characteristics (Per Leg)

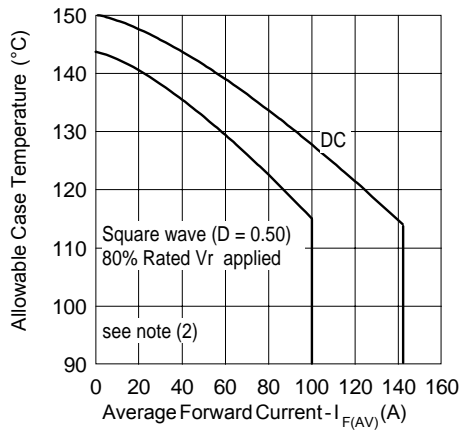

Fig. 5 - Max. Allowable Case Temperature Vs. Average Forward Current

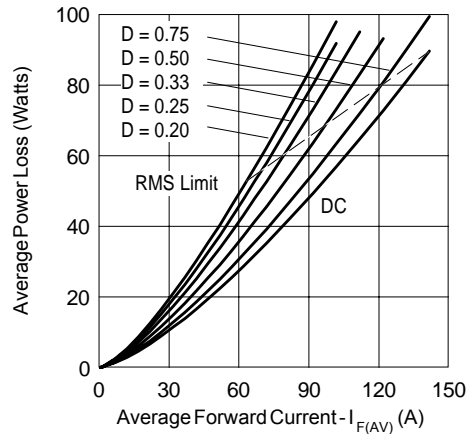

Fig. 6 - Forward Power Loss Characteristics

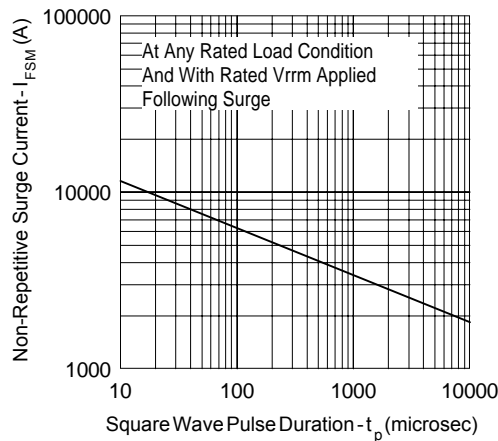

Fig. 7 - Max. Non-Repetitive Surge Current

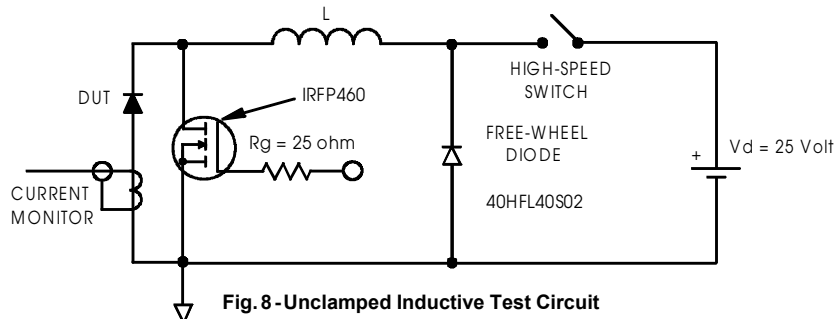

Fig. 8 - Unclamped Inductive Test Circuit

(2) Formula used: $T_c = T_j - (Pd + Pd_{REV}) \times R_{thJC}$
 $Pd = \text{Forward Power Loss} = I_{F(AV)} \times V_{FM} @ (I_{F(AV)} / D)$ (see Fig. 6);
 $Pd_{REV} = \text{Inverse Power Loss} = V_{R1} \times I_R (1 - D)$; $I_R @ V_{R1} = 80\% \text{ rated } V_R$

Data and specifications subject to change without notice.
This product has been designed and qualified for Industrial Level.
Qualification Standards can be found on IR's Web site.

International
IOR Rectifier

IR WORLD HEADQUARTERS: 233 Kansas St., El Segundo, California 90245, USA Tel: (310) 252-7105
TAC Fax: (310) 252-7309
Visit us at www.irf.com for sales contact information. 07/01