

Bulletin I2119 rev. C 03/99

International **IR** Rectifier

QUIETIR Series 20ETF..FP

**FAST SOFT RECOVERY
RECTIFIER DIODE
TO-220 FULLPAK**

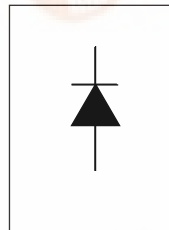

$V_F < 1.2V @ 10A$
 $I_{FSM} = 300A$
 $V_{RRM} 200 \text{ to } 600V$

Description/Features

The 20ETF.. FP soft recovery **QUIETIR** rectifier series has been optimized for combined short reverse recovery time and low forward voltage drop.

The glass passivation ensures stable reliable operation in the most severe temperature and power cycling conditions.

Typical applications are:

- output rectification and freewheeling in inverters, choppers and converters
- and input rectifications where severe restrictions on conducted EMI should be met
- fully isolated package ($V_{INS} = 2500 V_{RMS}$)

UL E78996 approved

Major Ratings and Characteristics

Characteristics	20ETF..FP	Units
$I_{F(AV)}$ Sinusoidal waveform	20	A
V_{RRM}	200to 600	V
I_{FSM}	300	A
$V_F @ 10A, T_J=25^\circ C$	1.2	V
$t_{rr} @ 1A, 100A/\mu s$	60	ns
T_J	-40to150	$^\circ C$

Package Outline

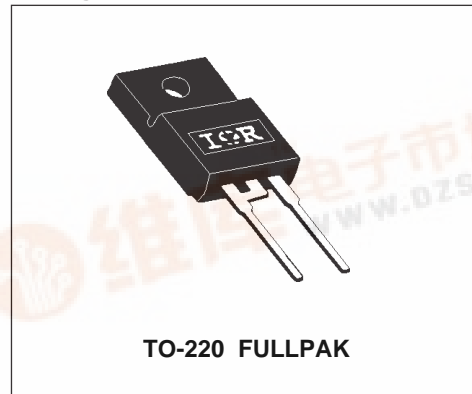

Voltage Ratings

Part Number	V _{RRM} , maximum peak reverse voltage V	V _{RSM} , maximum non repetitive peak reverse voltage V	I _{RRM} 150°C mA
20ETF02FP	200	300	5
20ETF04FP	400	500	
20ETF06FP	600	700	

Absolute Maximum Ratings

Parameters	20ETF..FP	Units	Conditions
I _{F(AV)} Max. Average Forward Current	20	A	@ T _C = 94°C, 180° conduction half sine wave
I _{FSM} Max. Peak One Cycle Non-Repetitive Surge Current	250	A	10ms Sine pulse, rated V _{RRM} applied
	300		10ms Sine pulse, no voltage reappplied
I ² t Max. I ² t for fusing	316	A ² s	10ms Sine pulse, rated V _{RRM} applied
	442		10ms Sine pulse, no voltage reappplied
I ² √t Max. I ² √t for fusing	4420	A ² √s	t = 0.1 to 10ms, no voltage reappplied

Electrical Specifications

Parameters	20ETF..FP	Units	Conditions
V _{FM} Max. Forward Voltage Drop	1.30	V	@ 20A, T _J = 25°C
	1.67	V	@ 60A, T _J = 25°C
r _t Forward slope resistance	12.5	mΩ	
V _{F(TO)} Threshold voltage	0.9	V	T _J = 150 °C
I _{RM} Max. Reverse Leakage Current	0.1	mA	T _J = 25 °C
	5.0	mA	T _J = 150 °C

V_R = rated V_{RRM}

Recovery Characteristics

Parameters	20ETF..FP	Units	Conditions
t _{rr} Reverse Recovery Time	160	ns	I _F @ 20A pk
I _{rr} Reverse Recovery Current	10	A	@ 100A/μs
Q _{rr} Reverse Recovery Charge	1.25	μC	@ 25°C
S Snap Factor	tb/ta	0.6	typical

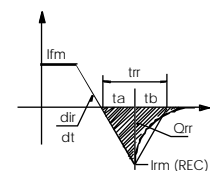

Thermal-Mechanical Specifications

Parameters		20ETF..FP	Units	Conditions
T_J	Max. Junction Temperature Range	-40 to 150	°C	
T_{stg}	Max. Storage Temperature Range	-40 to 150	°C	
R_{thJC}	Max. Thermal Resistance Junction to Case	1.5	°C/W	DC operation
R_{thJA}	Max. Thermal Resistance Junction to Ambient	62	°C/W	
R_{thCS}	Typical Thermal Resistance Case to Heatsink	1.5	°C/W	Mounting surface, smooth and greased
wt	Approximate Weight	2(0.07)	g(oz.)	
T	Mounting Torque	Min.	6(5)	Kg-cm (lbf-in)
		Max.	12(10)	
Case Style		TO-220FULLPAK		

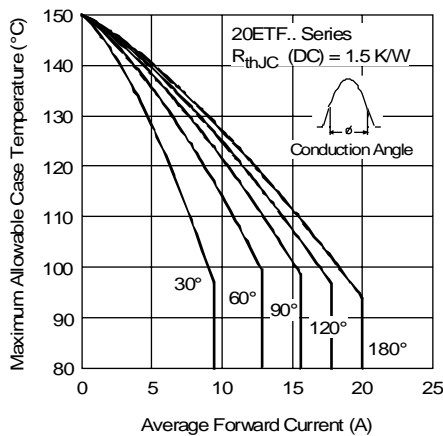

Fig. 1 - Current Rating Characteristics

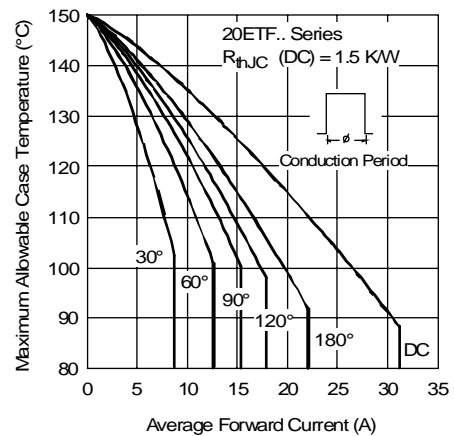

Fig. 2 - Current Rating Characteristics

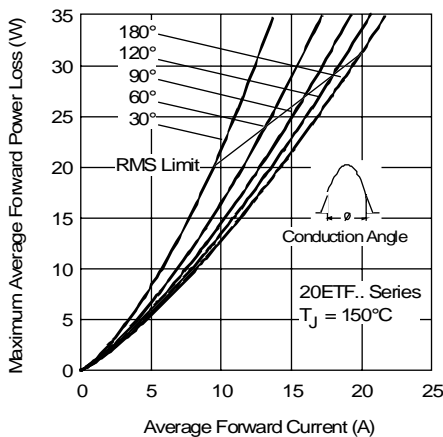

Fig. 3 - Forward Power Loss Characteristics

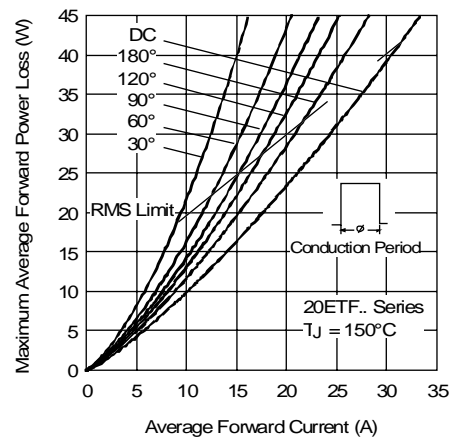

Fig. 4 - Forward Power Loss Characteristics

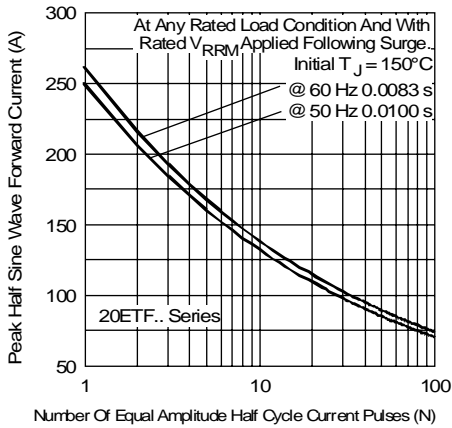

Fig. 5 - Maximum Non-Repetitive Surge Current

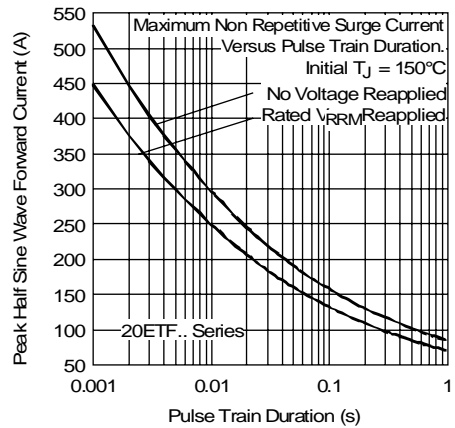

Fig. 6 - Maximum Non-Repetitive Surge Current

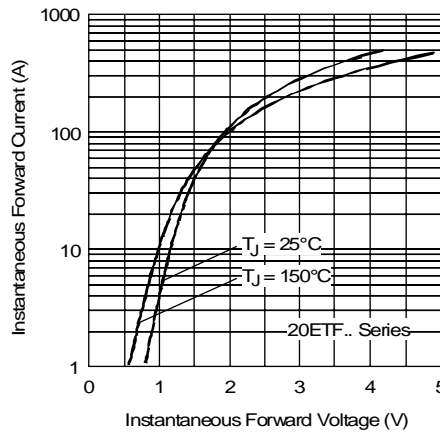

Fig. 7 - Forward Voltage Drop Characteristics

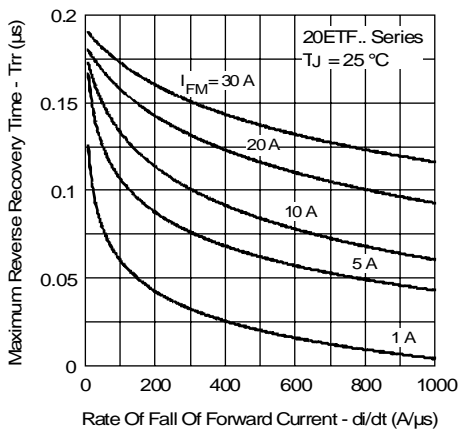

Fig. 8 - Recovery Time Characteristics, $T_J = 25^\circ\text{C}$

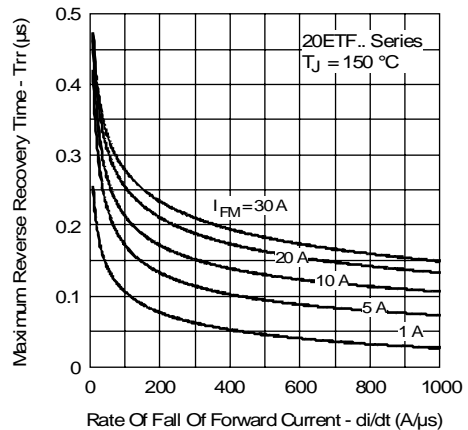

Fig. 9 - Recovery Time Characteristics, $T_J = 150^\circ\text{C}$

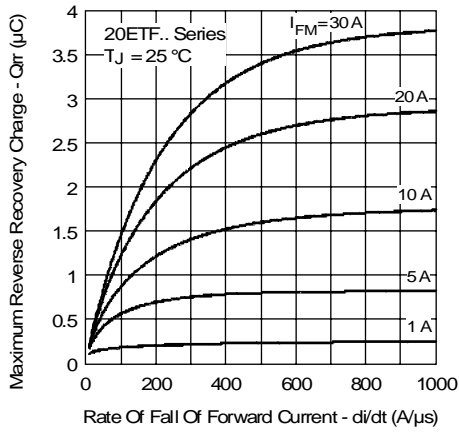

Fig. 10 - Recovery Charge Characteristics, $T_J = 25^\circ\text{C}$

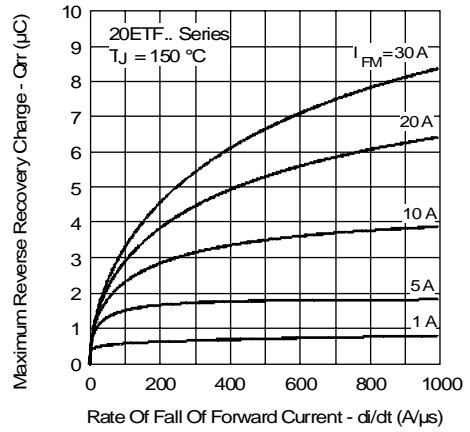

Fig. 11 - Recovery Charge Characteristics, $T_J = 150^\circ\text{C}$

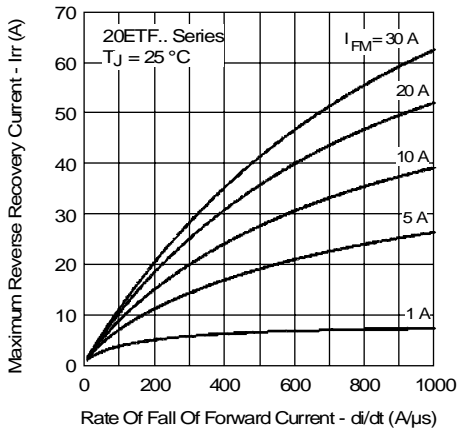

Fig. 12 - Recovery Current Characteristics, $T_J = 25^\circ\text{C}$

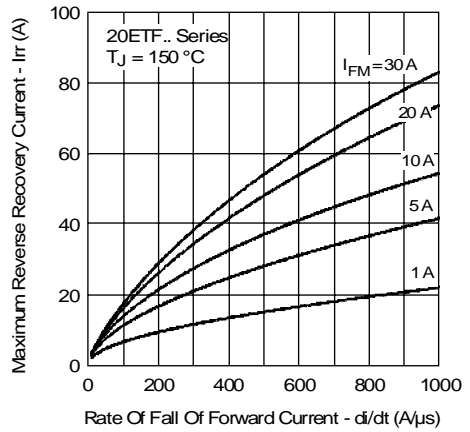

Fig. 13 - Recovery Current Characteristics, $T_J = 150^\circ\text{C}$

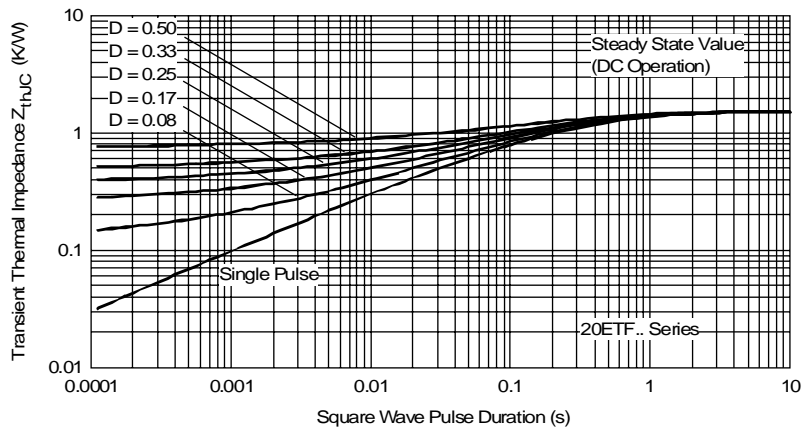
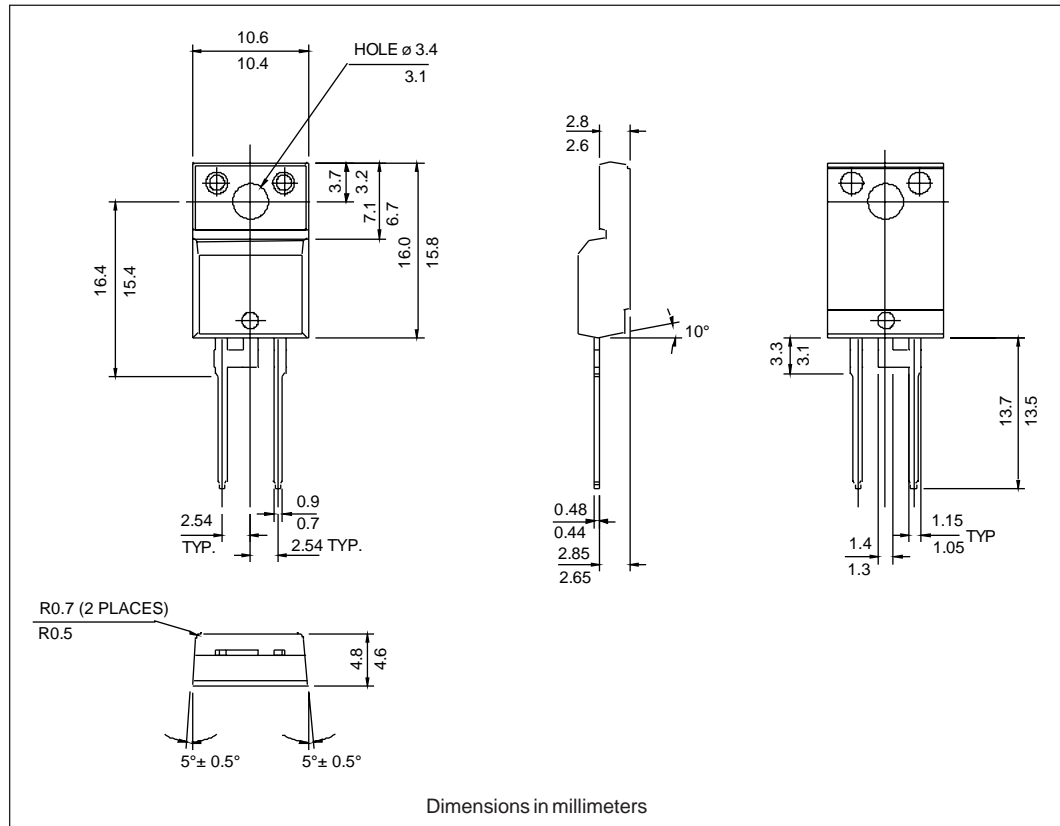
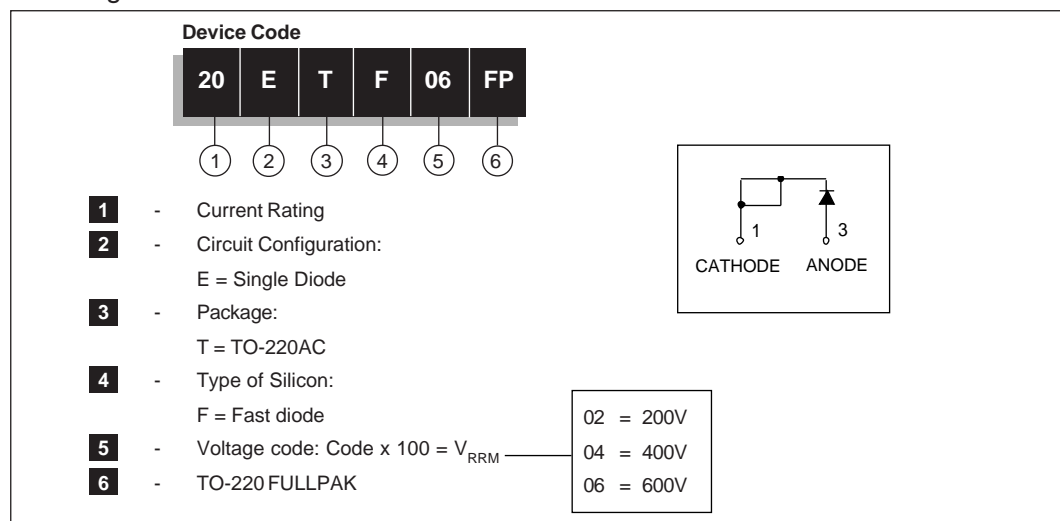

Fig. 14 - Thermal Impedance Z_{thJC} Characteristics

Outline Table



Ordering Information Table



WORLD HEADQUARTERS: 233 Kansas St., El Segundo, California 90245 U.S.A. Tel: (310) 322 3331. Fax: (310) 322 3332.
EUROPEAN HEADQUARTERS: Hurst Green, Oxted, Surrey RH8 9BB, U.K. Tel: ++ 44 1883 732020. Fax: ++ 44 1883 733408.
IR CANADA: 15 Lincoln Court, Brampton, Markham, Ontario L6T3Z2. Tel: (905) 453 2200. Fax: (905) 475 8801.
IR GERMANY: Saalburgstrasse 157, 61350 Bad Homburg. Tel: ++ 49 6172 96590. Fax: ++ 49 6172 965933.
IR ITALY: Via Liguria 49, 10071 Borgaro, Torino. Tel: ++ 39 11 4510111. Fax: ++ 39 11 4510220.
IR FAR EAST: K&H Bldg., 2F, 30-4 Nishi-Ikebukuro 3-Chome, Toshima-Ku, Tokyo, Japan 171. Tel: 81 3 3983 0086.
IR SOUTHEAST ASIA: 1 Kim Seng Promenade, Great World City West Tower, 13-11, Singapore 237994. Tel: ++ 65 838 4630.
IR TAIWAN: 16 Fl. Suite D.207, Sec. 2, Tun Haw South Road, Taipei, 10673, Taiwan. Tel: 886 2 2377 9936.