

> Features

- High Speed Switching
- Low On-Resistance
- No Secondary Breakdown
- Low Driving Power
- High Voltage
- VGS = ± 30V Guarantee
- Avalanche Proof

> Applications

- Switching Regulators
- UPS
- DC-DC converters
- General Purpose Power Amplifier

> Outline Drawing

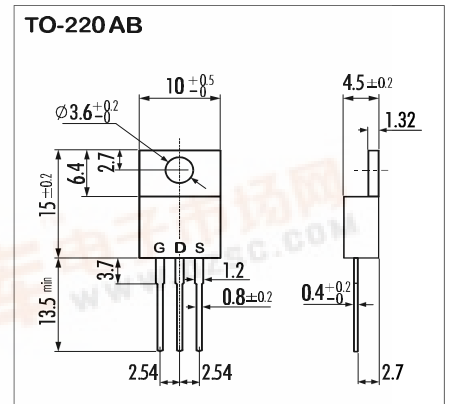

> Maximum Ratings and Characteristics

- Absolute Maximum Ratings (TC=25°C), unless otherwise specified

Item	Symbol	Rating	Unit
Drain-Source-Voltage	V _{DS}	450	V
Drain-Gate-Voltage (R _{GS} =20KΩ)	V _{DGR}	450	V
Continous Drain Current	I _D	9	A
Pulsed Drain Current	I _{D(puls)}	36	A
Gate-Source-Voltage	V _{GS}	±30	V
Max. Power Dissipation	P _D	60	W
Operating and Storage Temperature Range	T _{ch}	150	°C
	T _{stg}	-55 ~ +150	°C

> Equivalent Circuit

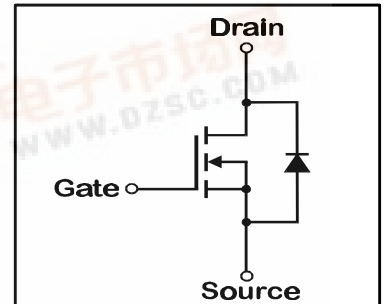

- Electrical Characteristics (TC=25°C), unless otherwise specified

Item	Symbol	Test conditions	Min.	Typ.	Max.	Unit
Drain-Source Breakdown-Voltage	V _{(BR)DSS}	I _D =1mA V _{GS} =0V	450			V
Gate Threshold Voltage	V _{GS(th)}	I _D =1mA V _{DS} =V _{GS}	2,5	3,0	3,5	V
Zero Gate Voltage Drain Current	I _{DSS}	V _{DS} =450V T _{ch} =25°C			500	μA
		V _{GS} =0V T _{ch} =125°C			1,0	mA
Gate Source Leakage Current	I _{GSS}	V _{GS} =±30V V _{DS} =0V		10	100	nA
Drain Source On-State Resistance	R _{DS(on)}	I _D =4,5A V _{GS} =10V		0,87	1,0	Ω
Forward Transconductance	g _{fs}	I _D =4,5A V _{DS} =25V	3,0	6,6		S
Input Capacitance	C _{iss}	V _{DS} =25V		1150	1700	pF
Output Capacitance	C _{oss}	V _{GS} =0V		130	200	pF
Reverse Transfer Capacitance	C _{rss}	f=1MHz		50	75	pF
Turn-On-Time t _{on} (t _{on} =t _{d(on)} +t _r)	t _{d(on)}	V _{CC} =300V		20	30	ns
	t _r	I _D =9A		50	75	ns
Turn-Off-Time t _{off} (t _{off} =t _{d(off)} +t _f)	t _{d(off)}	V _{GS} =10V		60	90	ns
	t _f	R _{GS} =10 Ω		35	55	ns
Avalanche Capability	I _{AV}	L = 100μH T _{ch} =25°C	9,0			A
Diode Forward On-Voltage	V _{SD}	I _F =2I _{DR} V _{GS} =0V T _{ch} =25°C		1,1	1,65	V
Reverse Recovery Time	t _{rr}	I _F =I _{DR} V _{GS} =0V		550		ns
Reverse Recovery Charge	Q _{rr}	-dI _F /dt=100A/μs T _{ch} =25°C		3,9		μC

- Thermal Characteristics

Item	Symbol	Test conditions	Min.	Typ.	Max.	Unit
Thermal Resistance	R _{th(ch-a)}	channel to air			75	°C/W
	R _{th(ch-c)}	channel to case			2,08	°C/W

N-channel MOS-FET			
450V	1Ω	9A	60W

2SK2523-01

FAP-II Series



> Characteristics

Typical Output Characteristics

$I_D = f(V_{DS})$; 80μs pulse test; $T_C = 25^\circ\text{C}$

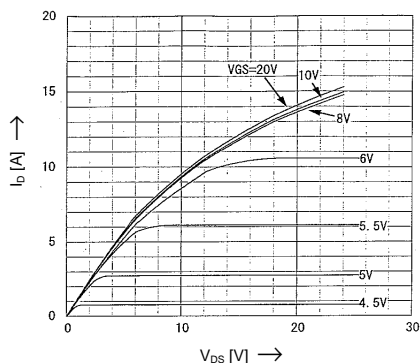

Drain-Source On-State Resistance

$R_{DS(on)} = f(T_{ch})$; $I_D = 4.5\text{A}$; $V_{GS} = 10\text{V}$

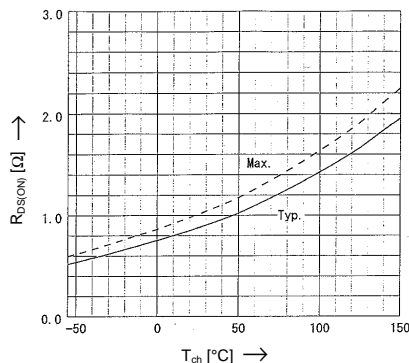

Typical Transfer Characteristics

$I_D = f(V_{GS})$; 80μs pulse test; $V_{DS} = 25\text{V}$; $T_{ch} = 25^\circ\text{C}$

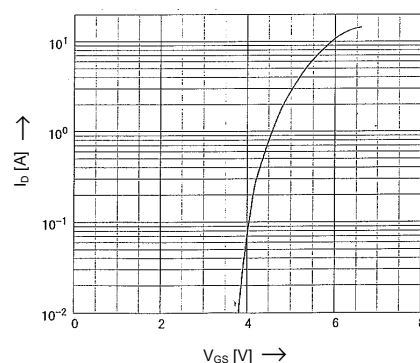

Typical Drain-Source On-State-Resistance

$R_{DS(on)} = f(I_D)$; 80μs pulse test; $T_C = 25^\circ\text{C}$

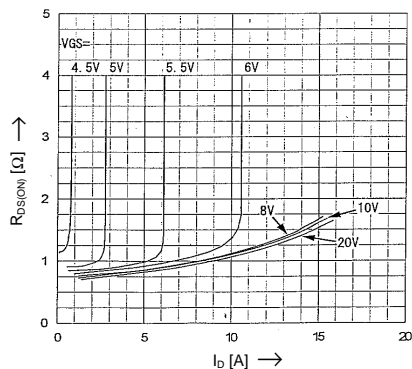

Typical Forward Transconductance

$g_{fs} = f(I_D)$; 80μs pulse test; $V_{DS} = 25\text{V}$; $T_C = 25^\circ\text{C}$

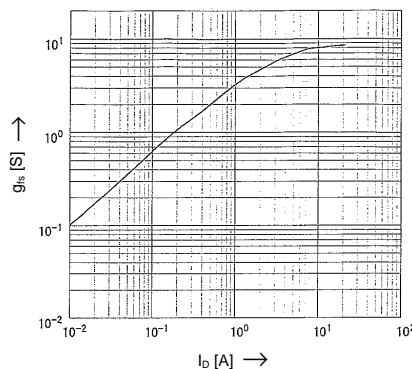

Gate Threshold Voltage

$V_{GS(th)} = f(T_{ch})$; $I_D = 1\text{mA}$; $V_{DS} = V_{GS}$

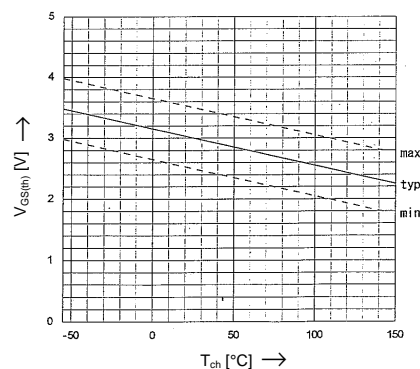

Typical Capacitances

$C = f(V_{DS})$; $V_{GS} = 0\text{V}$; $f = 1\text{MHz}$

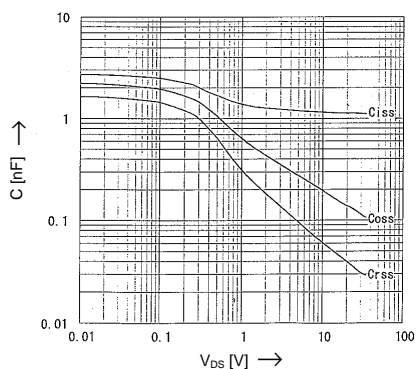

Typical Gate Charge Characteristics

$V_{GS} = f(Q_g)$; $I_D = 9\text{A}$; $T_C = 25^\circ\text{C}$

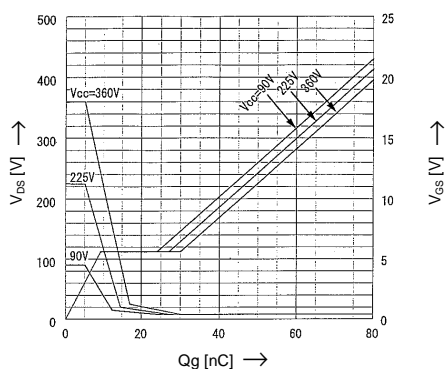

Forward Characteristics of Reverse Diode

$I_F = f(V_{SD})$; 80μs pulse test; $V_{GS} = 0\text{V}$

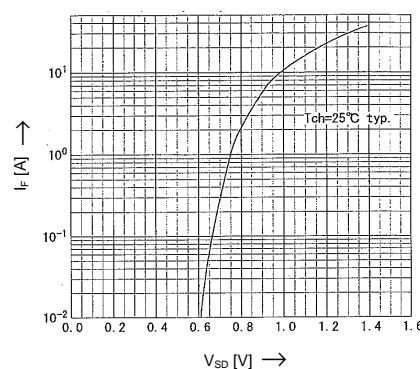

Power Dissipation

$P_D = f(T_C)$

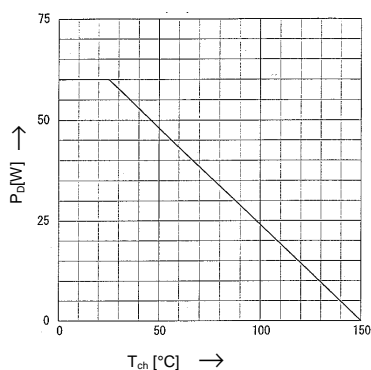

Safe Operation Area

$I_D = f(V_{DS})$; $D = 0.01$; $T_C = 25^\circ\text{C}$

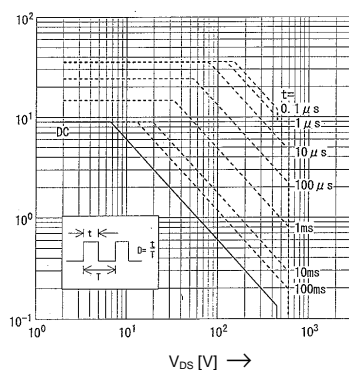

Transient Thermal impedance

$Z_{th(ch-c)} = f(t)$ parameter: $D = t/T$

