

> Features

- High Speed Switching
- Low On-Resistance
- No Secondary Breakdown
- Low Driving Power
- High Voltage
- VGS = ± 30V Guarantee
- Avalanche Proof

> Applications

- Switching Regulators
- UPS
- DC-DC converters
- General Purpose Power Amplifier

> Outline Drawing

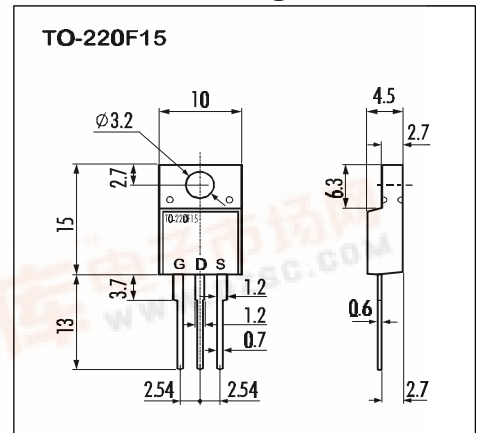

> Maximum Ratings and Characteristics

- Absolute Maximum Ratings (TC=25°C), unless otherwise specified

| Item | Symbol | Rating | Unit |
|---|----------------------|------------|------|
| Drain-Source-Voltage | V _{DS} | 250 | V |
| Drain-Gate-Voltage(R _{GS} =20KΩ) | V _{DGR} | 250 | V |
| Continous Drain Current | I _D | 8 | A |
| Pulsed Drain Current | I _{D(puls)} | 32 | A |
| Gate-Source-Voltage | V _{GS} | ±30 | V |
| Max. Power Dissipation | P _D | 40 | W |
| Operating and Storage Temperature Range | T _{ch} | 150 | °C |
| | T _{stg} | -55 ~ +150 | °C |

> Equivalent Circuit

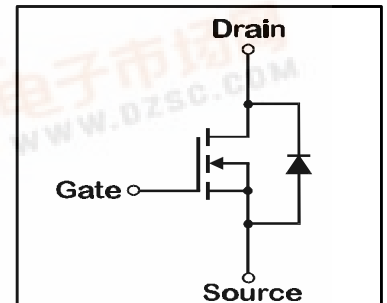

- Electrical Characteristics (TC=25°C), unless otherwise specified

| Item | Symbol | Test conditions | Min. | Typ. | Max. | Unit |
|---|----------------------|--|------|------|------|------|
| Drain-Source Breakdown-Voltage | V _{(BR)DSS} | I _D =1mA V _{GS} =0V | 250 | | | V |
| Gate Threshold Voltage | V _{GS(th)} | I _D =1mA V _{DS} =V _{GS} | 2,5 | 3,0 | 3,5 | V |
| Zero Gate Voltage Drain Current | I _{DSS} | V _{DS} =250V T _{ch} =25°C | | 10 | 500 | μA |
| | | V _{GS} =0V T _{ch} =125°C | | 0,2 | 1,0 | mA |
| Gate Source Leakage Current | I _{GSS} | V _{GS} =±30V V _{DS} =0V | | 10 | 100 | nA |
| Drain Source On-State Resistance | R _{DS(on)} | I _D =4A V _{GS} =10V | | 0,35 | 0,5 | Ω |
| Forward Transconductance | g _{fs} | I _D =4A V _{DS} =25V | 2,5 | 5 | | S |
| Input Capacitance | C _{iss} | V _{DS} =25V | | 750 | 1130 | pF |
| Output Capacitance | C _{oss} | V _{GS} =0V | | 130 | 200 | pF |
| Reverse Transfer Capacitance | C _{rss} | f=1MHz | | 30 | 45 | pF |
| Turn-On-Time t _{on} (t _{on} =t _{d(on)} +t _r) | t _{d(on)} | V _{CC} =150V | | 30 | 45 | ns |
| | t _r | I _D =8A | | 30 | 45 | ns |
| Turn-Off-Time t _{off} (t _{off} =t _{d(off)} +t _f) | t _{d(off)} | V _{GS} =10V | | 40 | 60 | ns |
| | t _f | R _{GS} =10 Ω | | 10 | 15 | ns |
| Avalanche Capability | I _{AV} | L=100μH T _{ch} =25°C | 8 | | | A |
| Continous Reverse Drain Current | I _{DR} | T _C =25°C | | | 8 | A |
| Pulsed Reverse Drain Current | I _{DRM} | T _C =25°C | | | 32 | A |
| Diode Forward On-Voltage | V _{SD} | I _F =2I _{DR} V _{GS} =0V T _{ch} =25°C | | 1 | 1,5 | V |
| Reverse Recovery Time | t _{rr} | I _F =I _{DR} V _{GS} =0V | | 120 | | ns |
| Reverse Recovery Charge | Q _{rr} | -di _F /dt=100A/μs T _{ch} =25°C | | 0,6 | | μC |

- Thermal Characteristics

| Item | Symbol | Test conditions | Min. | Typ. | Max. | Unit |
|--------------------|-----------------------|-----------------|------|------|-------|------|
| Thermal Resistance | R _{th(ch-a)} | channel to air | | | 62,5 | °C/W |
| | R _{th(ch-c)} | channel to case | | | 3,125 | °C/W |

| N-channel MOS-FET | | | |
|-------------------|------|----|-----|
| 250V | 0,5Ω | 8A | 40W |

2SK2253-01MR

FAP-IIA Series



> Characteristics

Typical Output Characteristics

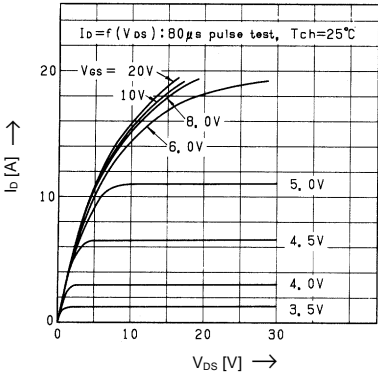

Drain-Source-On-State Resistance vs. T_{ch}

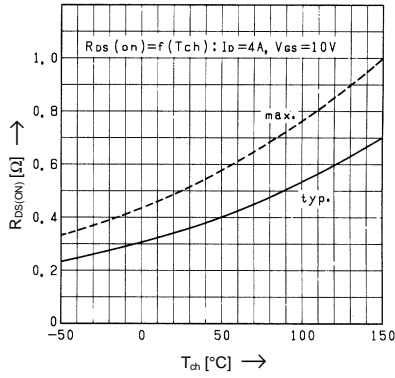

Typical Transfer Characteristics

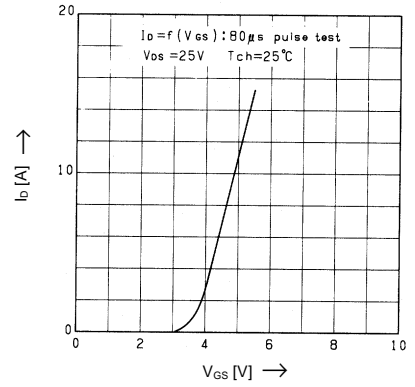

Typical Drain-Source-On-State-Resistance vs. Id

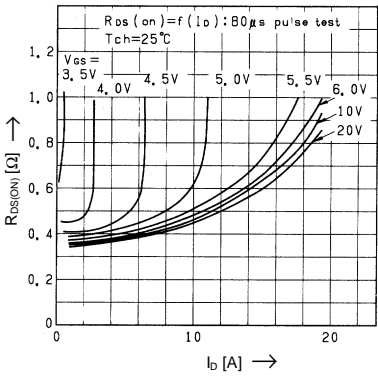

Typical Forward Transconductance vs. Id

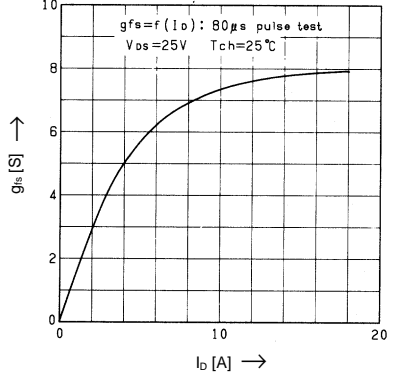

Gate Threshold Voltage vs. T_{ch}

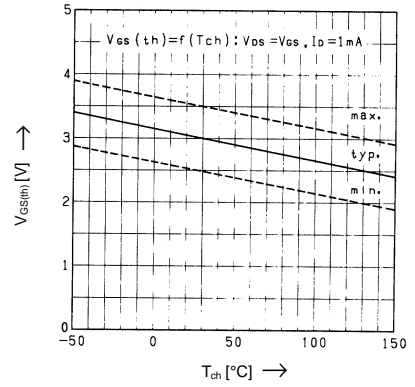

Typical Capacitance vs. V_{DS}

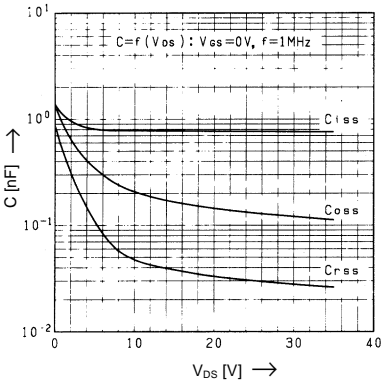

Typical Input Charge

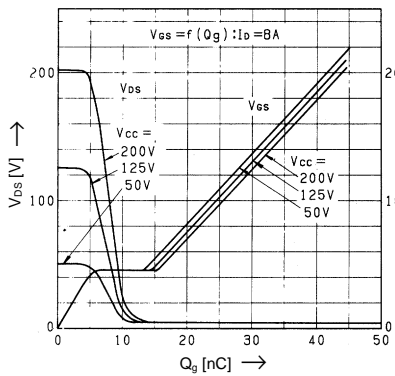

Forward Characteristics of Reverse Diode

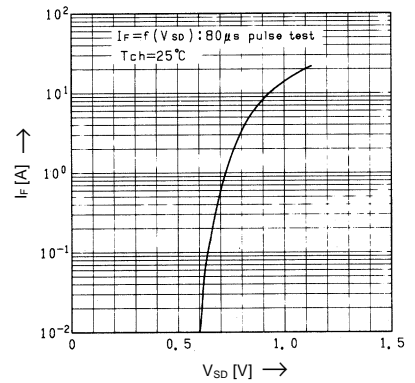

Allowable Power Dissipation vs. T_c

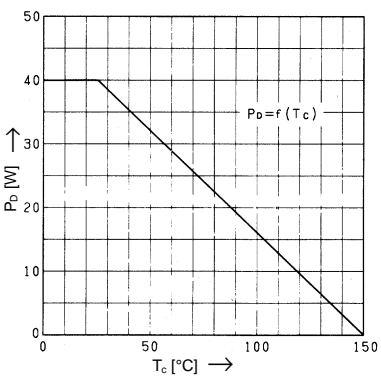

Safe operation area

