



LTC1232

Microprocessor Supervisory Circuit

FEATURES

- *Guaranteed* Reset Assertion at $V_{CC} = 1V$
- 8-Pin SOIC Plastic Package
- 2.0mA Maximum Supply Current
- 4.62V/4.37V Precision Voltage Monitor
- Power OK/Reset Time Delay: 600ms
- Minimum External Component Count
- Superior Upgrade for DS1232

APPLICATIONS

- Critical μP Power Monitoring
- Intelligent Instruments
- Computers and Controllers
- Automotive Systems

DESCRIPTION

The LTC1232 provides power supply monitoring, watchdog timing and external reset for microprocessor systems. A precise internal voltage reference and comparator circuit monitor the power supply line. When an out-of-tolerance condition occurs, the reset outputs are forced to active states. The \overline{RST} output is guaranteed to remain logic low even with V_{CC} as low as 1V.

The LTC1232 has an internal watchdog timer which forces the reset outputs to active states when the \overline{Strobe} input is not forced low prior to a preset time-out period. The watchdog timing can be set to operate on time-out periods of typically 150ms, 600ms or 1.2 seconds.

The LTC1232 performs push-button reset control. The LTC1232 debounces the push-button input and guarantees an active reset pulse width of 250ms minimum.

TYPICAL APPLICATION

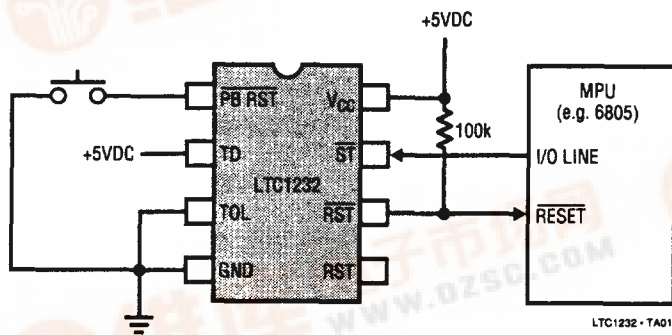

\overline{RST} Output Voltage vs Supply Voltage

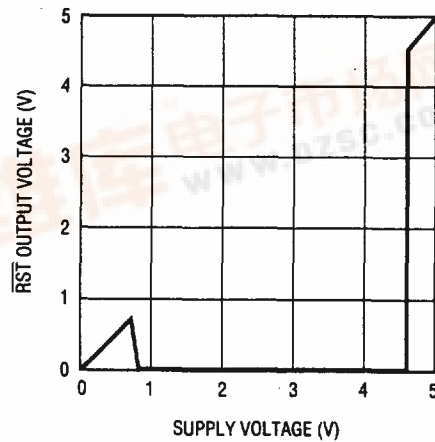

ABSOLUTE MAXIMUM RATINGS

(Notes 1 and 2)

Terminal Voltage

V_{CC} -0.3V to 7.0V

\overline{ST} and \overline{RST} -0.3V to 7.0V

All Other Inputs and Outputs -0.3V to $V_{CC} + 0.3V$

Power Dissipation 500mW

Operating Temperature Range

LTC1232C 0°C to 70°C

LTC1232I -40°C to 85°C

Storage Temperature Range -65°C to 150°C

Lead Temperature (Soldering, 10 sec.) 300°C

PACKAGE/ORDER INFORMATION

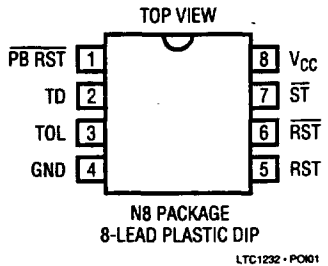
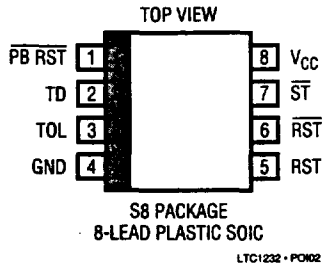
	ORDER PART NUMBER
	LTC1232CN8 LTC1232IN8
	LTC1232CS8 LTC1232IS8
	S8 PART MARKING
	1232 1232I

PRODUCT SELECTION GUIDE

	Pins	Reset	Watchdog Timer	Battery Backup	Power Fail Warning	RAM Write Protect	Push-Button Reset	Conditional Battery Backup
LTC1232	8	X	X				X	
LTC690	8	X	X	X	X			
LTC691	16	X	X	X	X	X		
LTC694	8	X	X	X	X			
LTC695	16	X	X	X	X	X		
LTC699	8	X	X					
LTC1235	16	X	X	X	X	X	X	X

RECOMMENDED OPERATING CONDITIONS V_{CC} = Full Operating Range

SYMBOL	PARAMETER	CONDITIONS	MIN	TYP	MAX	UNITS
V_{CC}	Supply Voltage	●	4.5	5.0	5.5	V
V_{IH}	\overline{ST} and $\overline{PB RST}$ Input High Level	●	2.0		$V_{CC}+0.3$	V
V_{IL}	\overline{ST} and $\overline{PB RST}$ Input Low Level	●	-0.3		0.8	V

DC ELECTRICAL CHARACTERISTICS V_{CC} = Full Operating Range

SYMBOL	PARAMETER	CONDITIONS	MIN	TYP	MAX	UNITS
I_{IL}	Input Leakage	(Note 3) ●	-1.0		1.0	μA
I_{OH}	Output Current at 2.4V	(Note 5) ●	-1.0	-13.0		mA
I_{OL}	Output Current at 0.4V	(Note 5) ●	2.0	6.0		mA
I_{CC}	Supply Current	(Note 4) ●		0.5	2.0	mA
V_{CCTP}	V_{CC} Trip Point	TOL = GND ●	4.50	4.62	4.74	V
V_{CCTP}	V_{CC} Trip Point	TOL = V_{CC} ●	4.25	4.37	4.49	V
V_{HYS}	V_{CC} Trip Point Hysteresis			40		mV
$V_{\overline{RST}}$	\overline{RST} Output Voltage at $V_{CC} = 1V$	$I_{SINK} = 10\mu A$		4	200	mV

AC CHARACTERISTICS V_{CC} = Full Operating Range

SYMBOL	PARAMETER	CONDITIONS	MIN	TYP	MAX	UNITS
t_{PB}	$\overline{PB RST} = V_{IL}$	●	40			ms
t_{RST}	RESET Active Time	●	250	610	1000	ms
t_{ST}	\overline{ST} Pulse Width	●	20			ns
t_{RPD}	V_{CC} Detect to \overline{RST} and \overline{RST}	●			100	ns
t_F	V_{CC} Slew Rate 4.75V-4.25V	●	300			μs
t_{RPU}	V_{CC} Detect to \overline{RST} and \overline{RST} (Reset Active Time)	$t_R = 5\mu s$ ●	250	610	1000	ms
t_R	V_{CC} Slew Rate 4.25V-4.75V	●	0			ns
t_{TD}	\overline{ST} Pin Detect to \overline{RST} and \overline{RST} (Watchdog Time-Out Period)	TD = GND ● TD = Floating ● TD = V_{CC} ●	60 250 500	150 610 1200	250 1000 2000	ms ms ms
C_{IN}	Input Capacitance			5		pF
C_{OUT}	Output Capacitance			5		pF

The ● indicates specifications which apply over the full operating temperature.

Note 1: Absolute maximum ratings are those values beyond which the life of a device may be impaired.

Note 2: All voltage values are with respect to GND.

Note 3: The $\overline{PB RST}$ pin is internally pulled up to V_{CC} with an internal impedance of 10k typical. The TD pin has internal bias current.

Note 4: Measured with outputs open.

Note 5: The \overline{RST} pin is an open drain output.

TIMING DIAGRAMS

Push-Button Reset

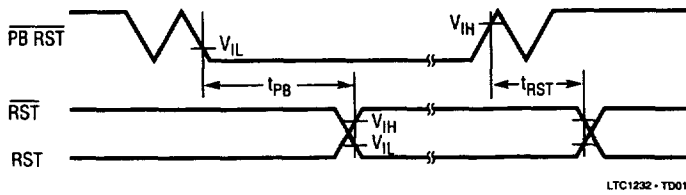

LTC1232 - TD01

Power Down

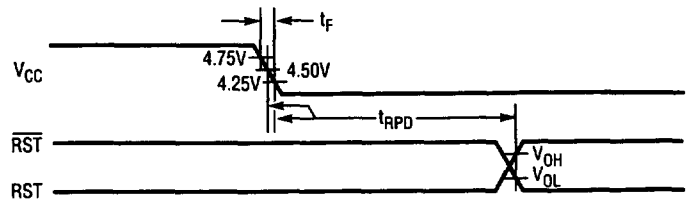

LTC1232 - TD03

Strobe Input

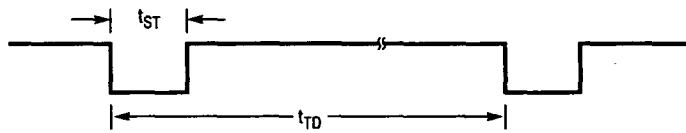

LTC1232 - TD02

Power Up

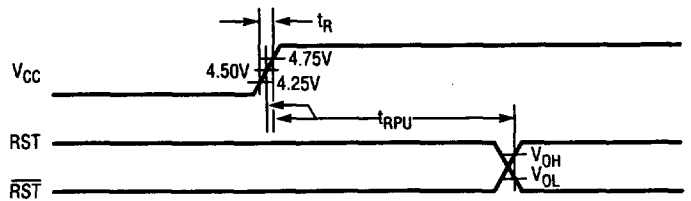

LTC1232 - TD04

BLOCK DIAGRAM

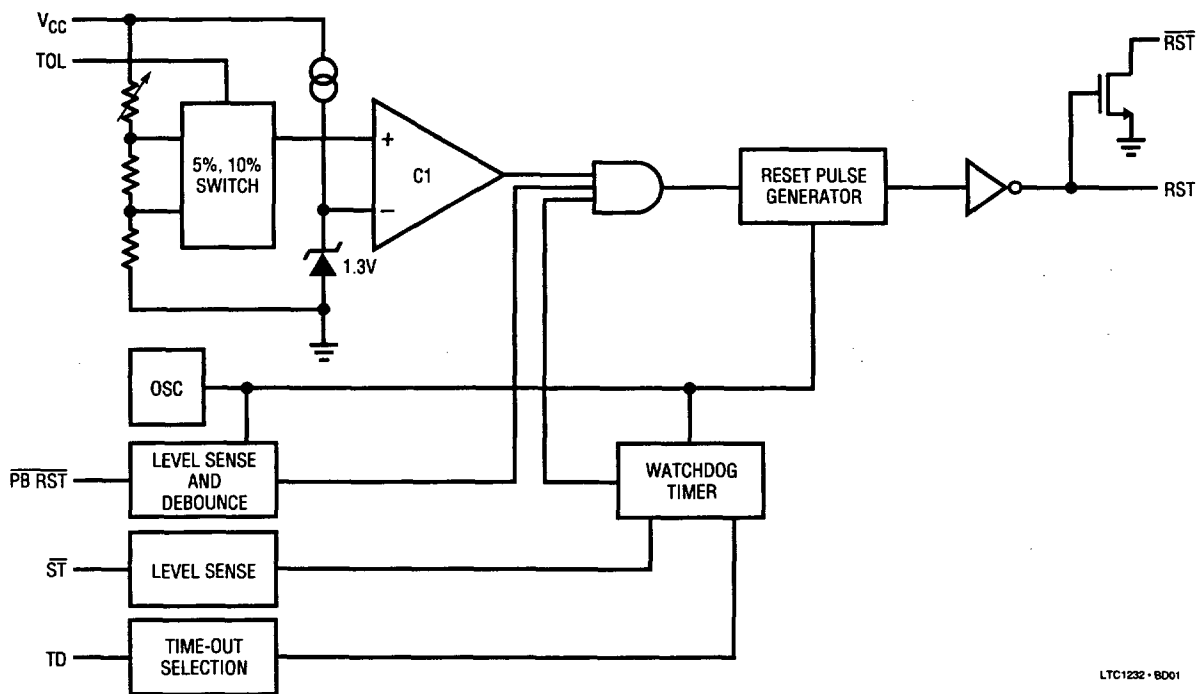

LTC1232 - BD01

TYPICAL PERFORMANCE CHARACTERISTICS

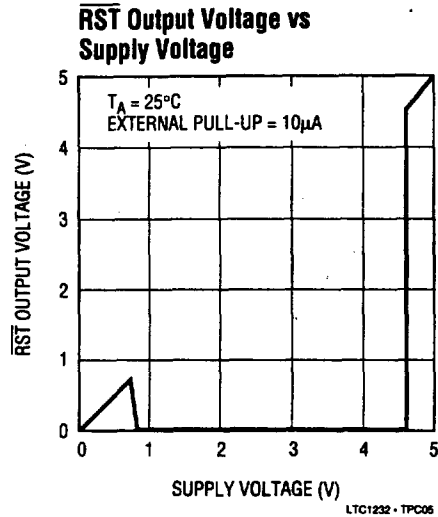
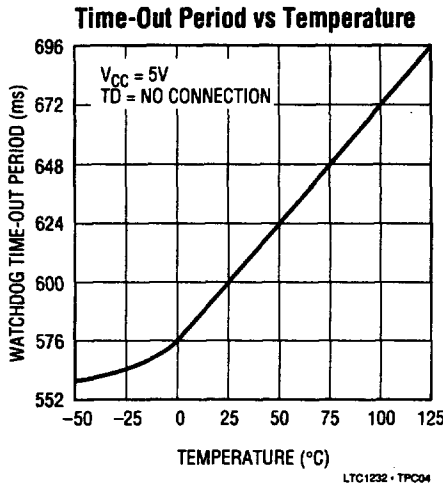
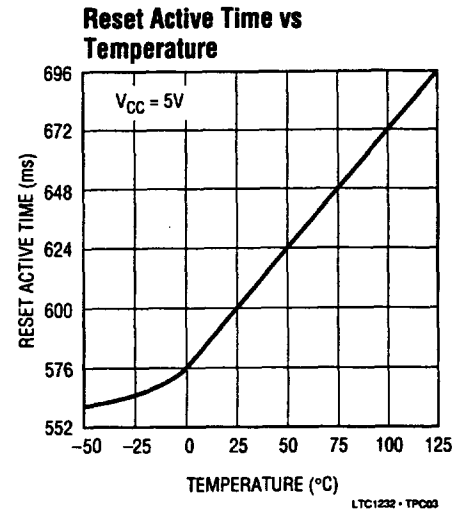
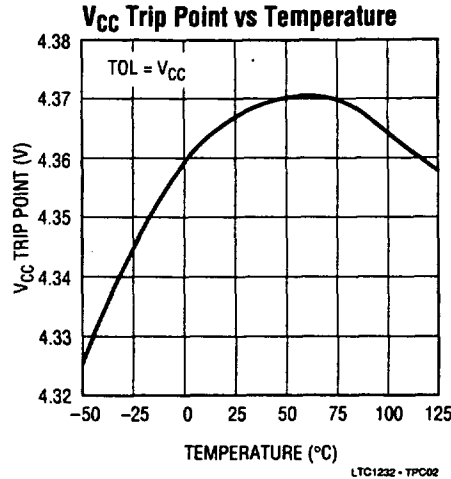
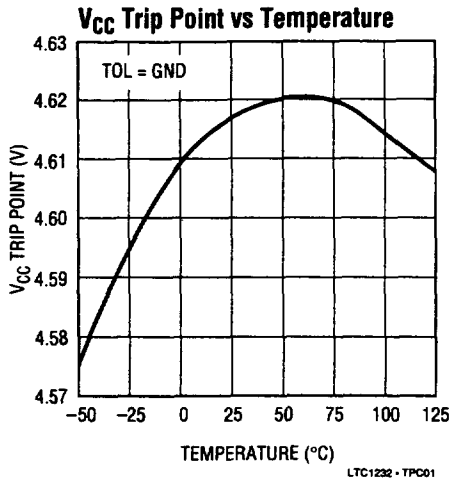

PIN FUNCTIONS

V_{CC}: +5V supply input. The V_{CC} pin should be bypassed with a 0.1μF capacitor.

GND: Ground pin.

PB RST: Logic input to be directly connected to a push-button. The PB RST input requires an active low signal which is debounced and timed for a minimum of 40ms. When this condition is satisfied, the reset pulse generator forces the reset outputs to active states. The reset outputs remain in active states for a minimum of 250ms after PB RST is released from logic low level.

TOL: Input to select 5% or 10% variation on V_{CC}. When TOL is connected to GND, the reset pulse generator forces the reset outputs to active states as V_{CC} falls below 4.75V (4.62V typical). When TOL is connected to V_{CC}, the reset pulse generator forces the reset outputs to active states as V_{CC} falls below 4.5V (4.37V typical).

TD: Time-out Delay, TD is a three level input to select three different time-out periods. The time-out period is set by the TD input to be 150ms with TD connected to GND, 600ms with TD left floating, and 1.2 seconds with TD connected to V_{CC}.

PIN FUNCTIONS

$\overline{\text{RST}}$: Open drain logic output for μP reset control. The LTC1232 provides three ways to generate μP reset. First, when V_{CC} falls below V_{CC} trip point (4.75V with TOL = GND and 4.5V with TOL = V_{CC}), $\overline{\text{RST}}$ goes active low. After V_{CC} returns to 5V, the reset pulse generator forces $\overline{\text{RST}}$ to remain active low for a minimum of 250ms. Second, when the watchdog timer is not serviced prior to a selected time-out period, the reset pulse generator also forces $\overline{\text{RST}}$ to active low for a minimum of 250ms and repeats for every time-out period. Third and the last, when the $\overline{\text{PB RST}}$ pin stays active low for a minimum of 40ms, $\overline{\text{RST}}$ becomes active low. The $\overline{\text{RST}}$ output will remain active low for a

minimum of 250ms from the moment the push-button reset input is released from logic low level.

RST : RST is an active high logic output. It is the inverse of $\overline{\text{RST}}$.

$\overline{\text{ST}}$: Logic input to reset the watchdog timer. Driving $\overline{\text{ST}}$ either high or low longer than the time-out period set by the TD input, forces the reset outputs to active states for a minimum of 250ms. The timer resets itself and begins to time-out again with each high to low transition on the $\overline{\text{ST}}$ input (see Figure 2).

APPLICATIONS INFORMATION

Power Monitoring

The LTC1232 uses a bandgap voltage reference and a precision voltage comparator, C1, to monitor the 5V supply input on V_{CC} (see BLOCK DIAGRAM). When V_{CC} falls below the V_{CC} trip point (4.62V typical with TOL = GND and 4.37V typical with TOL = V_{CC}), the reset outputs are forced to active states. The V_{CC} trip point accounts for a 5% or 10% variation on V_{CC} , so the reset outputs become active when V_{CC} falls below the V_{CC} trip point. On power-up, the reset signals are held in active states for a minimum of 250ms after the V_{CC} trip point is reached to allow the power supply and microprocessor to stabilize. On power-down, the $\overline{\text{RST}}$ signal remains active low even with V_{CC} as low as 1V. This capability helps hold the

microprocessor in stable shutdown condition. Figure 1 shows the timing diagram of the $\overline{\text{RST}}$ signal.

The precision voltage comparator, C1, typically has 40mV of hysteresis which ensures that glitches at V_{CC} pin do not activate the reset outputs. Response time is typically 10 μs . To help prevent mitriggering due to transient loads, V_{CC} pin should be bypassed with a 0.1 μF capacitor with the leads trimmed as short as possible.

Push-Button Reset

The LTC1232 provides a logic input pin, $\overline{\text{PB RST}}$, for direct connection to a push-button. This push-button reset input requires an active low signal. Internally, this input signal is debounced and timed for a minimum of 40ms. When

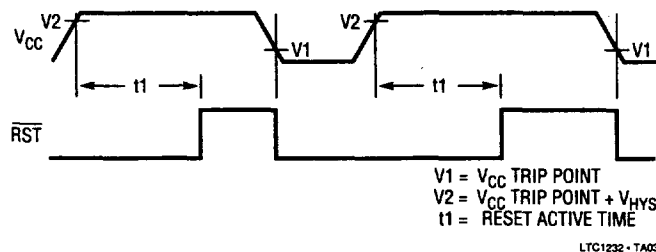

Figure 1. Reset Active Time

APPLICATIONS INFORMATION

this condition is satisfied, the reset pulse generator forces the reset outputs to active states. The reset signals will remain active for a minimum of 250ms from the moment the push-button reset input is released from logic low level (see TIMING DIAGRAM).

Watchdog Timer

The LTC1232 provides a watchdog timer function to monitor the activity of the microprocessor. If the microprocessor does not stimulate the strobe input, \overline{ST} , within a selected time-out period, the reset outputs are forced to active states for a minimum of 250ms. The time-out period is selected by the Time-out Delay input, TD, to be 150ms with TD connected to GND, 600ms with TD left floating, and 1.2 seconds with TD connected to V_{CC} . The 1.2 second time-out period is adequate for many systems to serve the watchdog timer immediately after a reset. Figure 2 shows the timing diagram of watchdog time-out period and reset active time. The watchdog time-out period is restarted as

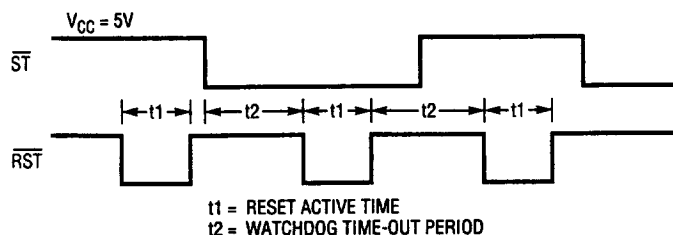

LTC1232 - TA04

Figure 2. Watchdog Time-Out Period and Reset Active Time

soon as the reset outputs are inactive. When a high-to-low transition occurs at the \overline{ST} pin prior to time-out, the watchdog time is reset and begins to time-out again. To ensure the watchdog time does not time-out, a high-to-low transition on the \overline{ST} pin must occur at or less than the minimum time-out period. If the input to the \overline{ST} pin remains either high or low, reset pulses will be issued for every time-out period selected by the TD pin. The watchdog timer is disabled when V_{CC} falls below the V_{CC} trip point.