



250MHz, Broadcast-Quality, Low-Power Video Op Amps

General Description

The MAX4102/MAX4103 op amps combine high-speed performance and ultra-low differential gain and phase while drawing only 5mA of supply current. The MAX4102 is compensated for unity-gain stability, while the MAX4103 is compensated for a closed-loop gain (A_{VCL}) of 2V/V or greater.

The MAX4102/MAX4103 deliver a 250MHz -3dB bandwidth (MAX4102) or a 180MHz -3dB bandwidth (MAX4103). Differential gain and phase are an ultra-low 0.002%/0.002° (MAX4102) and 0.008%/0.003° (MAX4103), making these amplifiers ideal for composite video applications.

These high-speed op amps have a wide output voltage swing of $\pm 3.4V$ ($R_L = 100\Omega$) and 80mA current-drive capability.

Applications

Broadcast and High-Definition TV Systems

Pulse/RF Amplifier

ADC/DAC Amplifier

Features

- ◆ 250MHz -3dB Bandwidth (MAX4102)
180MHz -3dB Bandwidth (MAX4103)
- ◆ Unity-Gain Stable (MAX4102)
- ◆ 350V/ μs Slew Rate
- ◆ Lowest Differential Gain/Phase ($R_L = 150\Omega$)
MAX4102: 0.002%/0.002°
MAX4103: 0.008%/0.003°
- ◆ Low Distortion (SFDR 5MHz): -78dBc
- ◆ 100dB Open-Loop Gain
- ◆ High Output Drive: 80mA
- ◆ Low Power: 5mA Supply Current

Ordering Information

PART	TEMP. RANGE	PIN-PACKAGE
MAX4102ESA	-40°C to +85°C	8 SO
MAX4103ESA	-40°C to +85°C	8 SO

Typical Application Circuit

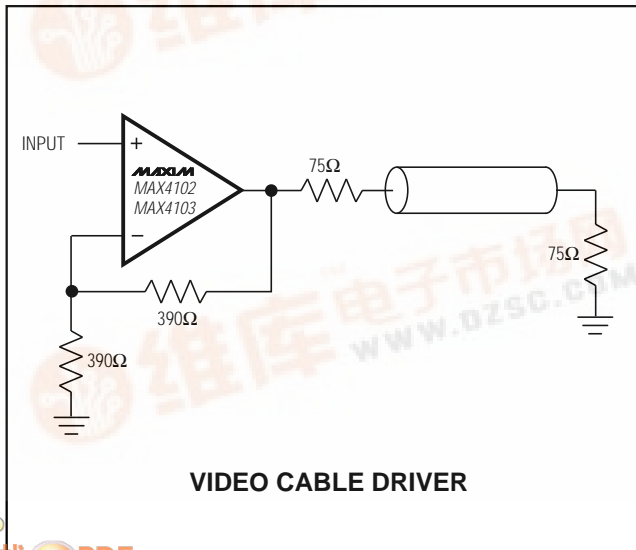

Pin Configuration

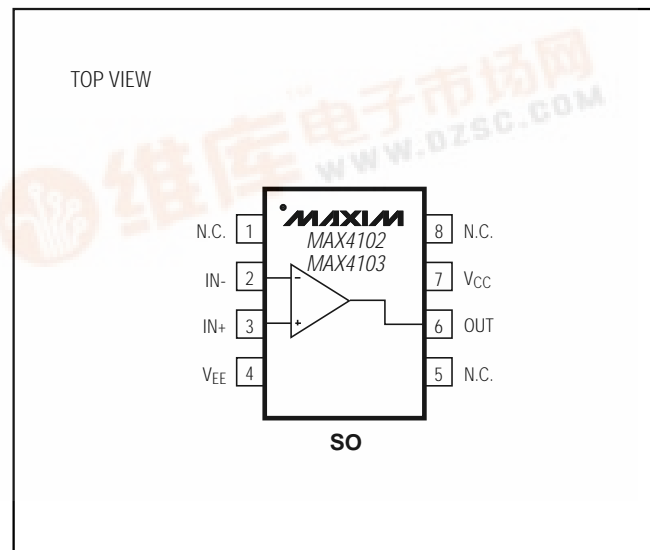

MAX4102/MAX4103

250MHz, Broadcast-Quality, Low-Power Video Op Amps

ABSOLUTE MAXIMUM RATINGS

Supply Voltage (V_{CC} to V_{EE})12V
 Voltage on Any Pin to Ground or Any Other Pin V_{CC} to V_{EE}
 Short-Circuit Duration (V_{OUT} to GND)Continuous
 Continuous Power Dissipation ($T_A = +70^\circ\text{C}$)
 SO (derate 5.88mW/ $^\circ\text{C}$ above $+70^\circ\text{C}$)471mW

Operating Temperature Range
 MAX4102ESA/MAX4103ESA -40°C to $+85^\circ\text{C}$
 Storage Temperature Range -65°C to $+160^\circ\text{C}$
 Lead Temperature (soldering, 10sec) $+300^\circ\text{C}$

Stresses beyond those listed under "Absolute Maximum Ratings" may cause permanent damage to the device. These are stress ratings only, and functional operation of the device at these or any other conditions beyond those indicated in the operational sections of the specifications is not implied. Exposure to absolute maximum rating conditions for extended periods may affect device reliability.

DC ELECTRICAL CHARACTERISTICS

($V_{CC} = 5\text{V}$, $V_{EE} = -5\text{V}$, $T_A = T_{MIN}$ to T_{MAX} , unless otherwise noted. Typical values are at $T_A = +25^\circ\text{C}$.)

PARAMETER	SYMBOL	CONDITIONS	MIN	TYP	MAX	UNITS
DC SPECIFICATIONS						
Input Offset Voltage	V_{OS}	$V_{OUT} = 0\text{V}$		0.5	8	mV
Input Offset Voltage Drift	TCV_{OS}	$V_{OUT} = 0\text{V}$		5		$\mu\text{V}/^\circ\text{C}$
Input Bias Current	I_B	$V_{OUT} = 0\text{V}$, $V_{IN} = -V_{OS}$		3	9	μA
Input Offset Current	I_{OS}	$V_{OUT} = 0\text{V}$, $V_{IN} = -V_{OS}$		0.04	0.5	μA
Common-Mode Input Resistance	R_{INCM}	Either input		5		$\text{M}\Omega$
Common-Mode Input Capacitance	C_{INCM}	Either input		1		pF
Input Voltage Noise	e_n	$f = 100\text{kHz}$	MAX4102	7		$\text{nV}/\sqrt{\text{Hz}}$
			MAX4103	5		
Integrated Voltage Noise		$f = 1\text{MHz to } 100\text{MHz}$	MAX4102	88		μVRMS
			MAX4103	63		
Input Current Noise	i_n	$f = 100\text{kHz}$	MAX4102	1.0		$\text{pA}/\sqrt{\text{Hz}}$
			MAX4103	1.0		
Integrated Current Noise		$f = 1\text{MHz to } 100\text{MHz}$	MAX4102	12.5		nARMS
			MAX4103	12.5		
Common-Mode Input Voltage	V_{CM}		-2.5		2.5	V
Common-Mode Rejection	CMR	$V_{CM} = \pm 2.5\text{V}$	75	100		dB
Power-Supply Rejection	PSR	$V_S = \pm 4.5\text{V to } \pm 5.5\text{V}$	70	100		dB
Open-Loop Voltage Gain	AVOL	$V_{OUT} = \pm 2.0\text{V}$, $V_{CM} = 0\text{V}$	$R_L = \infty$	66	96	dB
			$R_L = 100\Omega$	70	100	
Quiescent Supply Current	I_{SY}	$V_{IN} = 0\text{V}$		4.6	6	mA
Output Voltage Swing	V_{OUT}	$R_L = \infty$	± 3.3	± 3.7	V	
		$R_L = 100\Omega$	± 3.1	± 3.4		
Output Current		$R_L = 30\Omega$, $T_A = 0^\circ\text{C to } +85^\circ\text{C}$	65	80		mA
Short-Circuit Output Current	I_{SC}	Short to ground or either supply voltage		90		mA

250MHz, Broadcast-Quality, Low-Power Video Op Amps

MAX4102/MAX4103

AC ELECTRICAL CHARACTERISTICS

($V_{CC} = 5V$, $V_{EE} = -5V$, $R_L = 100\Omega$, $A_{VCL} = +1$ (MAX4102), $A_{VCL} = +2$ (MAX4103), $T_A = +25^\circ C$, unless otherwise noted.)

PARAMETER	SYMBOL	CONDITIONS		MIN	TYP	MAX	UNITS
AC SPECIFICATIONS							
-3dB Bandwidth	BW	$V_{OUT} \leq 0.1V_{RMS}$	MAX4102		250		MHz
			MAX4103		180		
0.1dB Bandwidth			MAX4102		130		MHz
			MAX4103		80		
Slew Rate	SR	$-2V \leq V_{OUT} \leq 2V$			350		V/ μs
Settling Time	t_s	$-1V \leq V_{OUT} \leq 1V$		to 0.1%	18		ns
				to 0.01%	30		
Rise/Fall Times	t_R, t_F	$10\% \text{ to } 90\%, -2V \leq V_{OUT} \leq 2V$			13		ns
		$10\% \text{ to } 90\%, -50mV \leq V_{OUT} \leq 50mV$			1.5		
Differential Gain	DG	$f = 3.58MHz$, $R_L = 150\Omega$	MAX4102		0.002		%
			MAX4103		0.008		
Differential Phase	DP	$f = 3.58MHz$, $R_L = 150\Omega$	MAX4102		0.002		degrees
			MAX4103		0.003		
Input Capacitance	C_{IN}				2		pF
Output Resistance	R_{OUT}	$f = 10MHz$	MAX4102		0.7		Ω
			MAX4103		0.7		
Spurious-Free Dynamic Range	SFDR	$f_C = 5MHz$, $V_{OUT} = 2V_{p-p}$	MAX4102		-78		dBc
			MAX4103		-76		

Typical Operating Characteristics

($V_{CC} = 5V$, $V_{EE} = -5V$, $R_L = 100\Omega$, $T_A = +25^\circ C$, unless otherwise noted.)

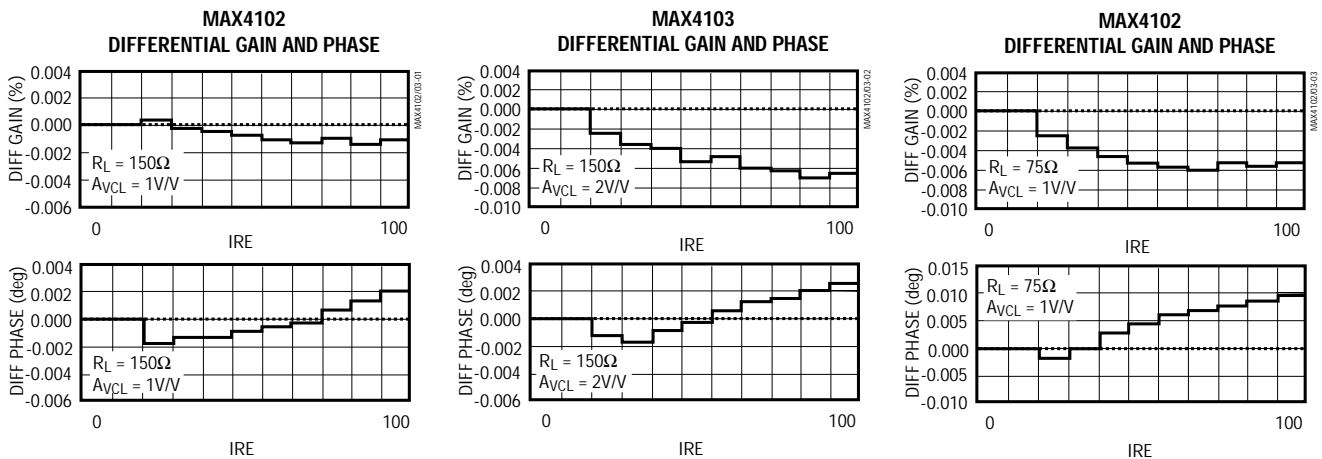

250MHz, Broadcast-Quality, Low-Power Video Op Amps

Typical Operating Characteristics (continued)

($V_{CC} = 5V$, $V_{EE} = -5V$, $R_L = 100\Omega$, $T_A = +25^\circ C$, unless otherwise noted.)

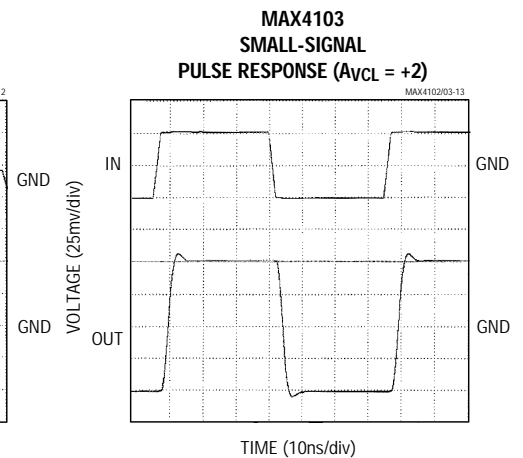
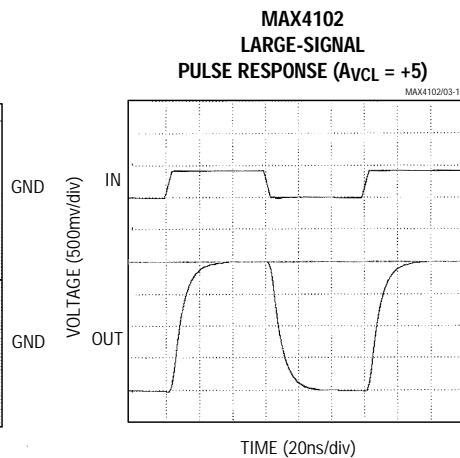
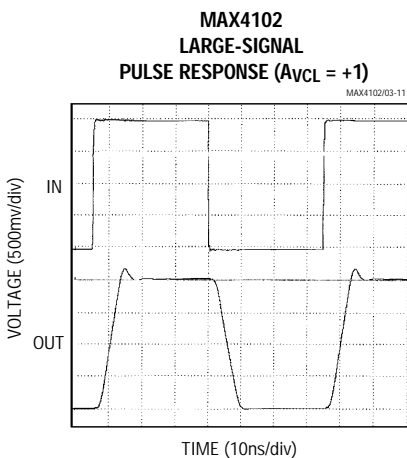
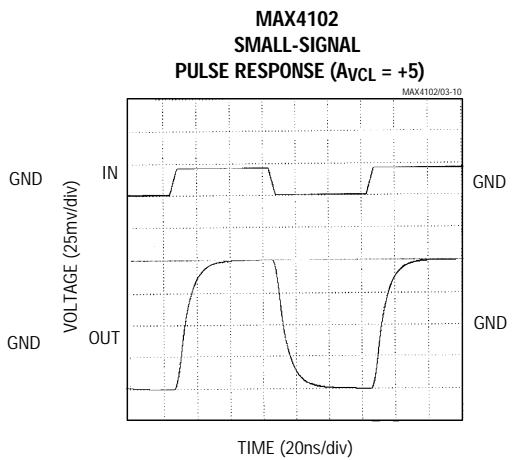
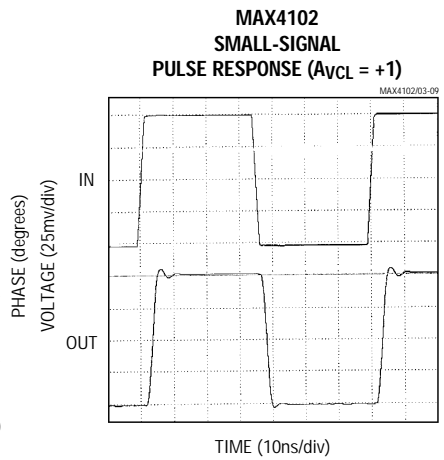
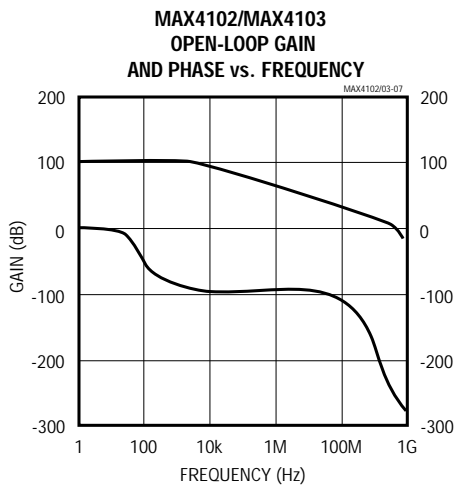
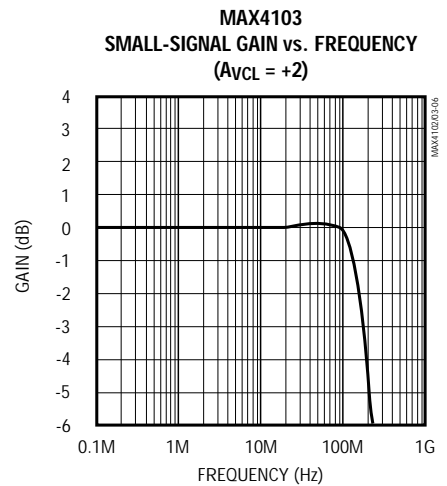
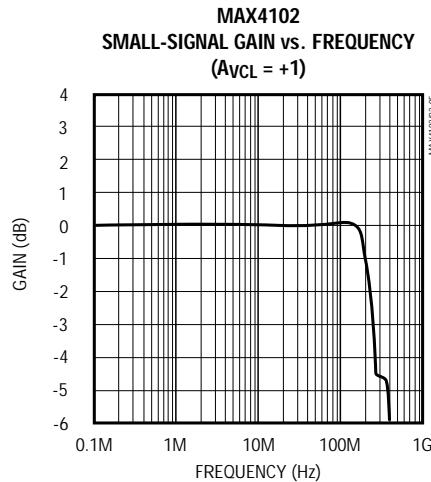
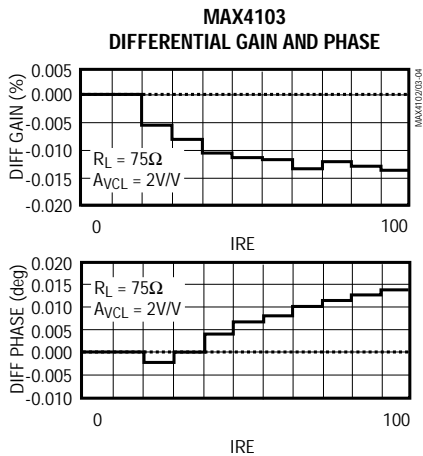

250MHz, Broadcast-Quality, Low-Power Video Op Amps

Typical Operating Characteristics (continued)

($V_{CC} = 5V$, $V_{EE} = -5V$, $R_L = 100\Omega$, $T_A = +25^\circ C$, unless otherwise noted.)

MAX4102/MAX4103

MAX4103
SMALL-SIGNAL
PULSE RESPONSE ($A_{VCL} = +10$)

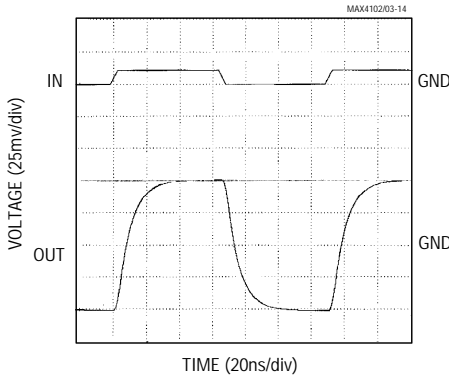

MAX4103
LARGE-SIGNAL
PULSE RESPONSE ($A_{VCL} = +2$)

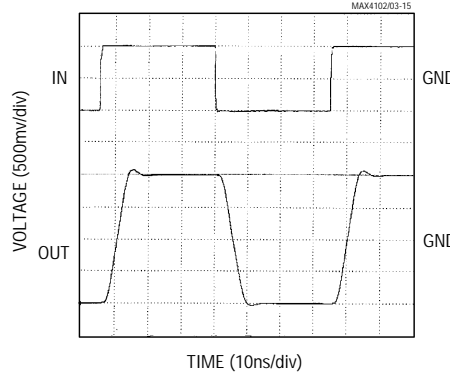

MAX4103
LARGE-SIGNAL
PULSE RESPONSE ($A_{VCL} = +10$)

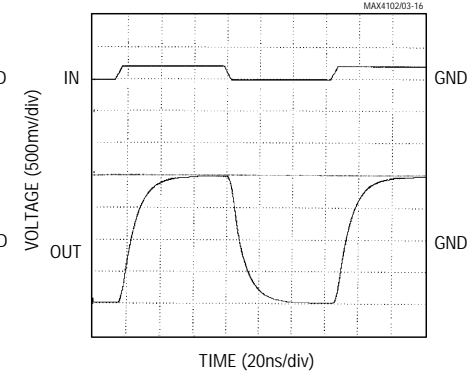

MAX4102
DISTORTION vs. FREQUENCY
($A_{VCL} = +1$)

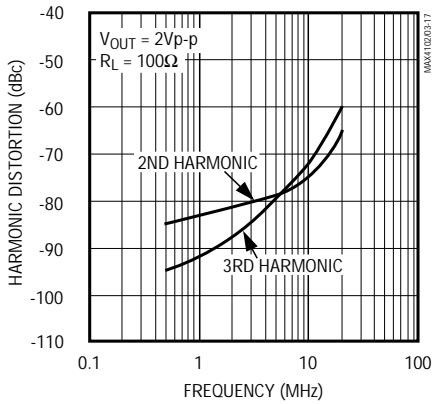

MAX4102
TOTAL HARMONIC DISTORTION
vs. FREQUENCY

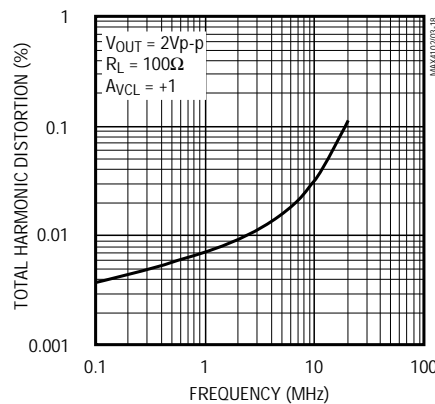

MAX4103
DISTORTION vs. FREQUENCY
($A_{VCL} = +2$)

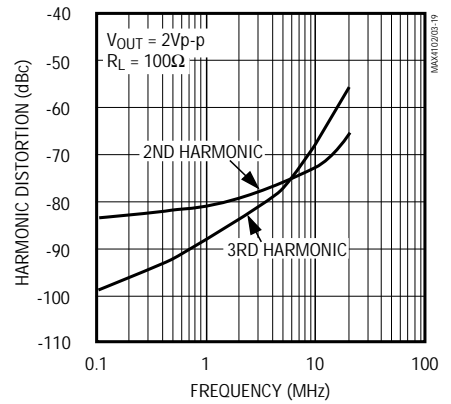

MAX4103
TOTAL HARMONIC DISTORTION
vs. FREQUENCY

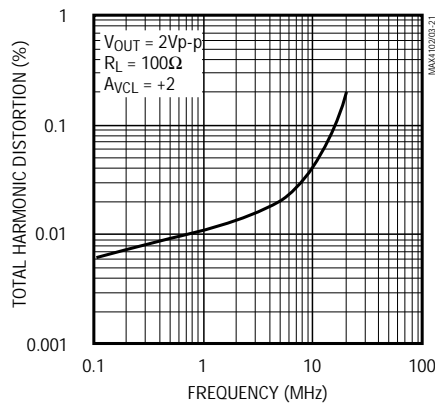

MAX4103
DISTORTION vs. FREQUENCY
($A_{VCL} = +5$)

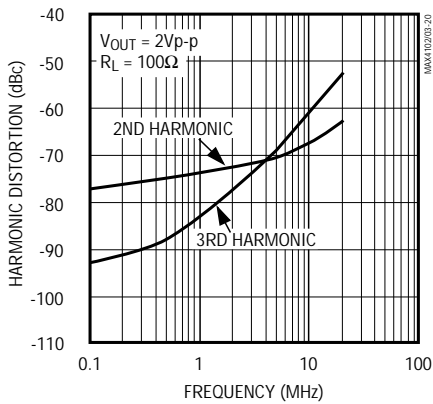

MAX4102
5MHz DISTORTION vs. LOAD

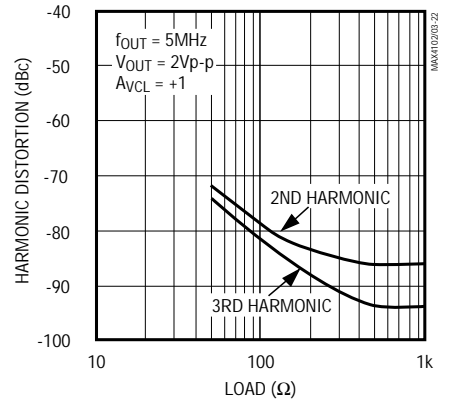

250MHz, Broadcast-Quality, Low-Power Video Op Amps

Typical Operating Characteristics (continued)

($V_{CC} = 5V$, $V_{EE} = -5V$, $R_L = 100\Omega$, $T_A = +25^\circ C$, unless otherwise noted.)

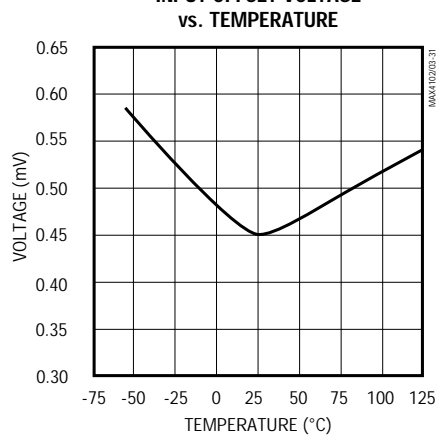
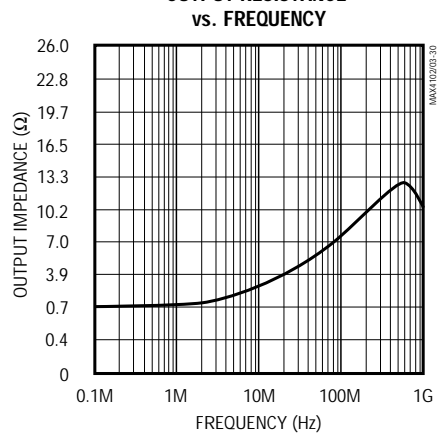
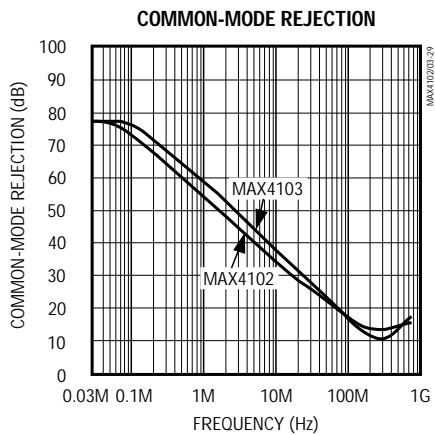
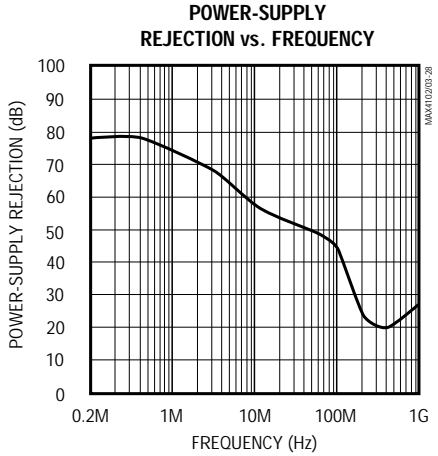
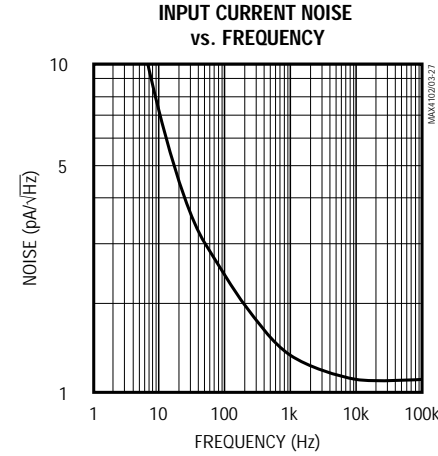
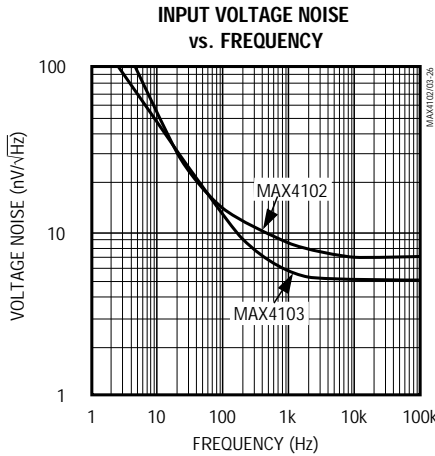
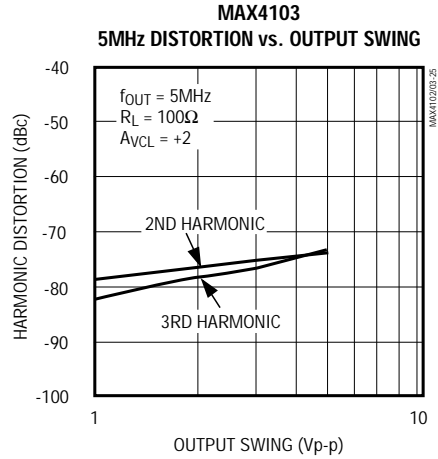
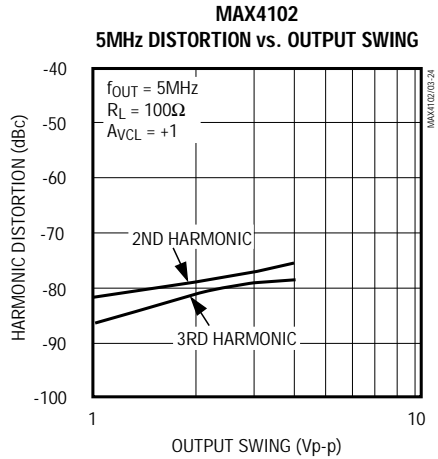
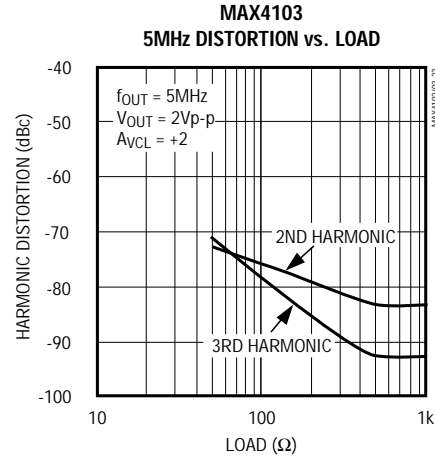

250MHz, Broadcast-Quality, Low-Power Video Op Amps

Typical Operating Characteristics (continued)

($V_{CC} = 5V$, $V_{EE} = -5V$, $R_L = 100\Omega$, $T_A = +25^\circ C$, unless otherwise noted.)

MAX4102/MAX4103

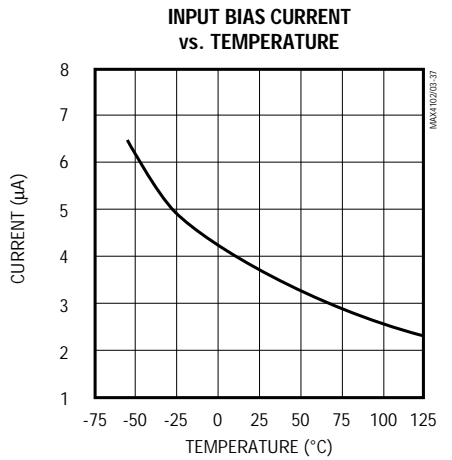
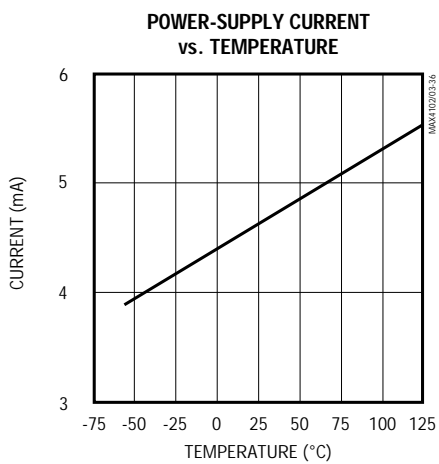
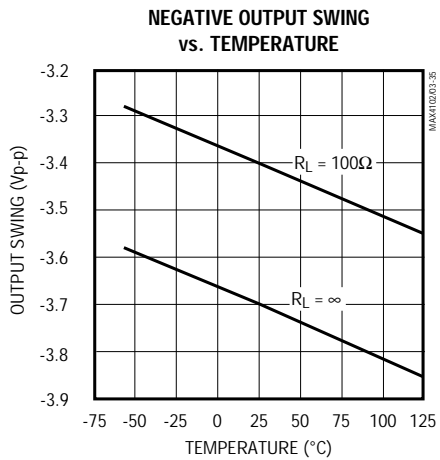
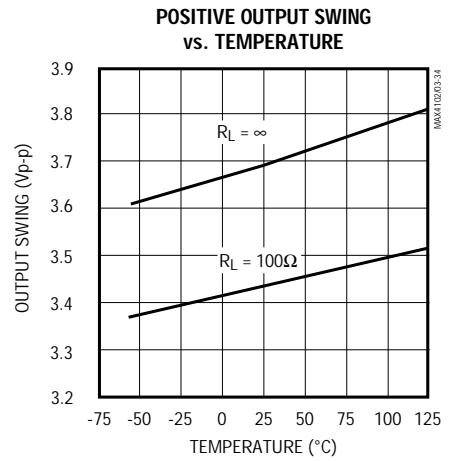
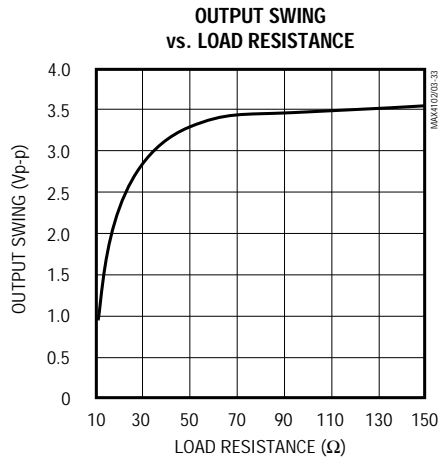
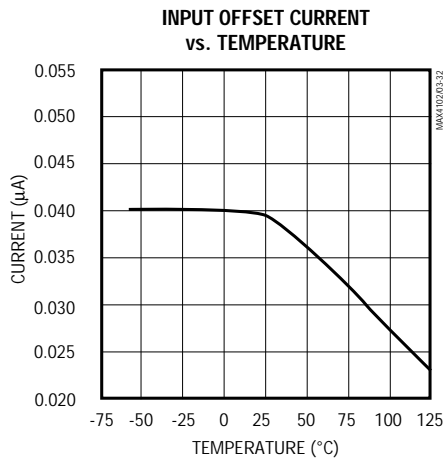

250MHz, Broadcast-Quality, Low-Power Video Op Amps

Pin Description

PIN	NAME	FUNCTION
1	N.C.	Not internally connected
2	IN-	Inverting Input
3	IN+	Noninverting Input
4	VEE	Negative Power Supply. Connect to -5V
5	N.C.	Not internally connected
6	OUT	Amplifier Output
7	VCC	Positive Power Supply. Connect to +5V
8	N.C.	Not internally connected

Detailed Description

The MAX4102/MAX4103 low-power, high-speed op amps feature ultra-low differential gain and phase, and are optimized for the highest quality video applications. Differential gain and phase errors are 0.002%/0.002° for the MAX4102 and 0.008%/0.003° for the MAX4103. The MAX4102 also features a -3dB bandwidth of over 250MHz and 0.1dB gain-flatness of 130MHz. The MAX4103 features a -3dB bandwidth of 180MHz and a 0.1dB bandwidth of 80MHz.

The MAX4102 is unity-gain stable, and the MAX4103 is optimized for closed-loop gains of 2V/V (6dB) and higher. Both devices drive back-terminated 50Ω or 75Ω cables to ±3.1V (min) and deliver an output current of 80mA.

Available in a small 8-pin SO package, the MAX4102/MAX4103 are ideal for high-definition TV systems (in RGB, broadcast, or consumer video applications) that benefit from low power consumption and superior differential gain and phase characteristics.

Applications Information

Grounding, Bypassing, and PC Board Layout

In order to achieve the full bandwidth, Microstrip and Stripline techniques are recommended in most cases. To ensure your PC board does not degrade the amp's performance, it's wise to design the board for a frequency greater than 1GHz. Even with very short runs, it's good practice to use this technique at critical points, such as inputs and outputs. Whether you use a constant-impedance board or not, observe the following guidelines when designing the board:

- Do not use wire-wrap boards, because they are too inductive.
- Do not use IC sockets. They increase parasitic capacitance and inductance.
- In general, surface-mount components have shorter leads and lower parasitic reactance, and give better high-frequency performance than through-hole components.
- The PC board should have at least two layers, with one side a signal layer and the other a ground plane.
- Keep signal lines as short and as straight as possible. Do not make 90° turns; round all corners.
- The ground plane should be as free from voids as possible.

On Maxim's evaluation kit, the ground plane has been removed from areas where keeping the trace capacitance to a minimum is more important than maintaining ground continuity. For example, the ground plane has been removed from beneath the IC to minimize pin capacitance.

The bypass capacitors should include a 0.1μF at each supply pin and the ground plane, located as close to the package as possible. Then place a 10μF to 15μF low-ESR tantalum at the point of entry (to the PC board) of the power-supply pins. The power-supply trace should lead directly from the tantalum capacitor to the VCC and VEE pins to maintain the low differential gain and phase of these devices.

Setting Gain

The MAX4102/MAX4103 are voltage-feedback op amps that can be configured as an inverting or noninverting gain block, as shown in Figures 1a and 1b. The gain is determined by the ratio of two resistors and does not affect amplifier frequency compensation.

In the unity-gain configuration (Figure 1c), maximum bandwidth and stability are achieved with the MAX4102 when a small feedback resistor is included. This resistor suppresses the negative effects of parasitic inductance and capacitance. A value of 24Ω provides the best combination of wide bandwidth, low peaking, and fast settling time. In addition, this resistor reduces the errors from input bias currents.

Choosing Resistor Values

The values of feedback and input resistors used in the inverting or noninverting gain configurations are not critical (as is the case with current-feedback amplifiers), but should be kept small and noninductive.

250MHz, Broadcast-Quality, Low-Power Video Op Amps

MAX4102/MAX4103

The input capacitance of the MAX4102/MAX4103 is approximately 2pF. In either the inverting or noninverting configuration, the bandwidth limit caused by the package capacitance and resistor time constant is $f_{3dB} = 1 / (2\pi RC)$, where R is the parallel combination of the input and feedback resistors (R_F and R_G in Figure 2) and C is the package and board capacitance at the inverting input. R_{S1} and R_{S2} represent the input termination resistors. Table 1 shows the typical bandwidth and resistor values for several gain configurations.

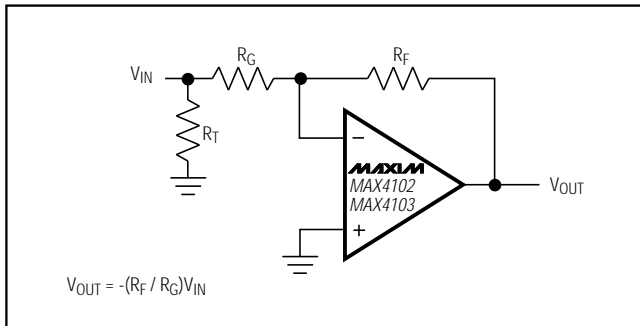

Figure 1a. Inverting Gain Configuration

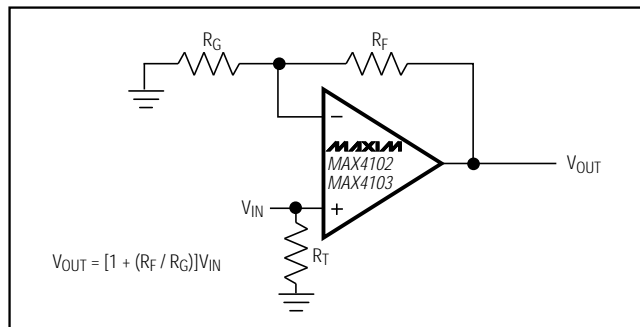

Figure 1b. Noninverting Gain Configuration

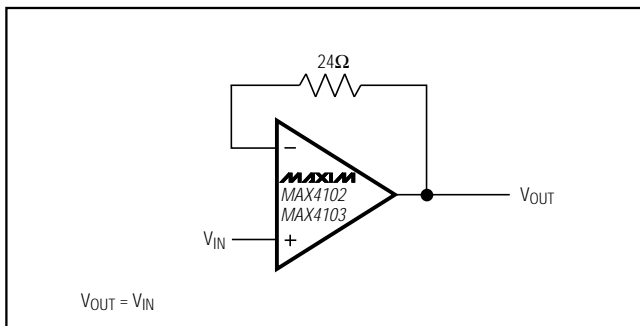

Figure 1c. MAX4102 Unity-Gain Buffer Configuration

Table 1. Resistor and Bandwidth Values for Various Gain Configurations

DEVICE	GAIN (V/V)	R_G (Ω)	R_F (Ω)	R_T (Ω)	BANDWIDTH (MHz)
MAX4102	1	∞	24	50	250
MAX4102	2	200	200	50	100
MAX4103	2	200	200	50	180
MAX4103	5	50	200	50	40
MAX4103	10	30	270	50	20
MAX4103	-1	200	200	56	180
MAX4103	-2	75	150	150	140
MAX4103	-5	50	250	∞	75
MAX4103	-10	50	500	∞	35

Note: Refer to Figure 1a for inverting gain configurations and Figure 1b for noninverting gain configurations. R_T is calculated for 50 Ω systems.

Resistor Types

Surface-mount resistors are the best choice for high-frequency circuits. They are of similar material to the metal-film resistors, but are deposited using a thick-film process in a flat, linear manner so that inductance is minimized. Their small size and lack of leads also minimize parasitic inductance and capacitance, thereby yielding more predictable performance.

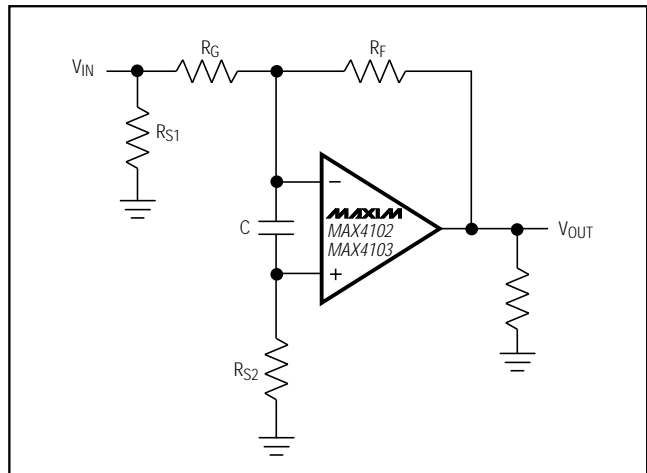

Figure 2. Effect of Feedback Resistor Values and Parasitic Capacitance on Bandwidth

250MHz, Broadcast-Quality, Low-Power Video Op Amps

Driving Capacitive Loads

When driving 50Ω or 75Ω back-terminated transmission lines, capacitive loading is not an issue. The MAX4102/MAX4103 can typically drive 5pF and 20pF, respectively. Figure 3a illustrates how a capacitive load influences the amplifier's peaking without an isolation resistor (R_S). Figure 3b shows how an isolation resistor decreases the amplifier's peaking. By using a small isolation resistor

between the amplifier output and the load, large capacitance values may be driven without oscillation (Figure 4a). In most cases, less than 50Ω is sufficient. Use Figure 4b to determine the value needed in your application. Determine the worst-case maximum capacitive load you may encounter and select the appropriate resistor from the graph.

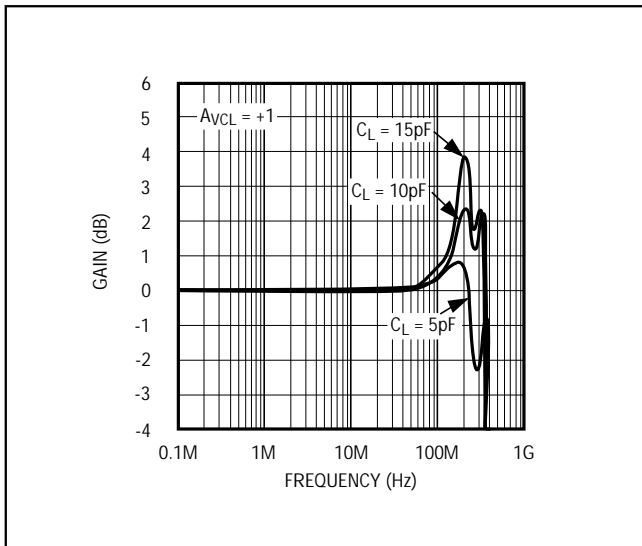

Figure 3a. MAX4102 Bandwidth vs. Capacitive Load (No Isolation Resistor (R_S))

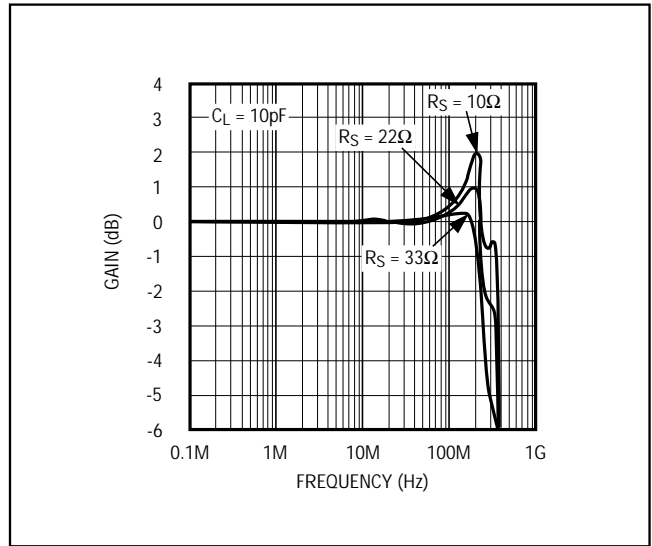

Figure 3b. MAX4102 Bandwidth vs. 10pF Capacitive Load and Isolation Resistor

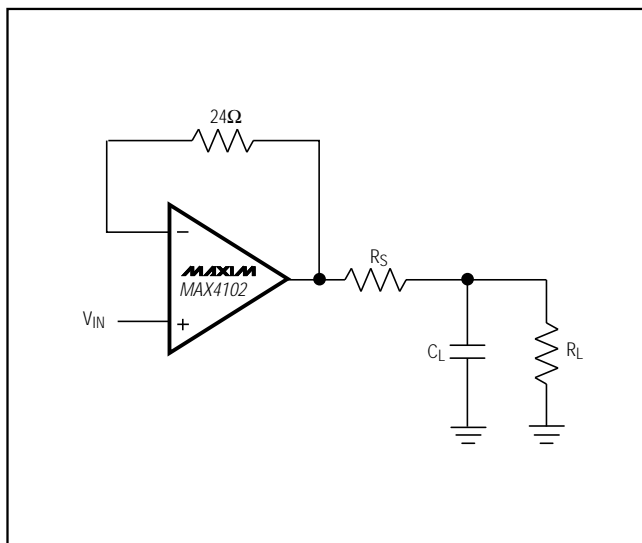

Figure 4a. Using an Isolation Resistor (R_S) for Large Capacitive Loads (MAX4102)

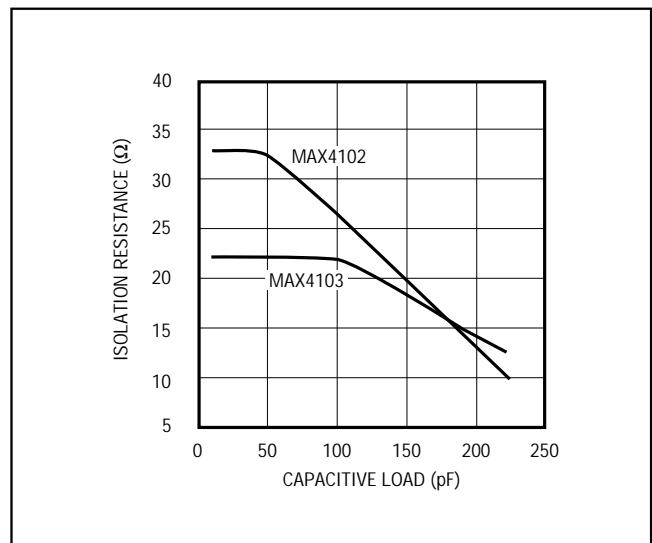

Figure 4b. Isolation vs. Capacitive Load

250MHz, Broadcast-Quality, Low-Power Video Op Amps

Package Information

MAX4102/MAX4103

**Narrow SO
SMALL-OUTLINE
PACKAGE
(0.150 in.)**

DIM	INCHES		MILLIMETERS	
	MIN	MAX	MIN	MAX
A	0.053	0.069	1.35	1.75
A1	0.004	0.010	0.10	0.25
B	0.014	0.019	0.35	0.49
C	0.007	0.010	0.19	0.25
E	0.150	0.157	3.80	4.00
e	0.050		1.27	
H	0.228	0.244	5.80	6.20
L	0.016	0.050	0.40	1.27

DIM	PINS	INCHES		MILLIMETERS	
		MIN	MAX	MIN	MAX
D	8	0.189	0.197	4.80	5.00
D	14	0.337	0.344	8.55	8.75
D	16	0.386	0.394	9.80	10.00

21-0041A

Chip Information

TRANSISTOR COUNT: 51

SUBSTRATE CONNECTED TO: VEE

MAX4102/MAX4103

250MHz, Broadcast-Quality, Low-Power Video Op Amps

Maxim cannot assume responsibility for use of any circuitry other than circuitry entirely embodied in a Maxim product. No circuit patent licenses are implied. Maxim reserves the right to change the circuitry and specifications without notice at any time.

12 _____ Maxim Integrated Products, 120 San Gabriel Drive, Sunnyvale, CA 94086 (408) 737-7600

© 1996 Maxim Integrated Products

Printed USA

MAXIM is a registered trademark of Maxim Integrated Products.