

**2N4199
thru
2N4204**

**SCRs
100 AMPERE PULSE
300 thru 800 VOLTS**



**CASE 63-03
(TO-64)
STYLE 1**

**Designer's Data Sheet
Silicon Controlled Rectifiers
Reverse Blocking Triode Thyristors**

... fast switching, high-voltage Thyristors especially designed for pulse modulator applications in radar and other similar equipment.

- Guaranteed Limits on All Critical Parameters
- High-Voltage: $V_{DRM} = 300$ to 800 Volts
- Maximum Turn-On Times Specified — 300 to 400 ns
- Repetitive Pulse Current to 100 Amperes
- Stable Switching Characteristics Over an Operating Temperature Range From -65 to $+105^{\circ}\text{C}$
- Pulse Repetition Rates as High as 20,000 pps
- JAN Versions Available

MAXIMUM RATINGS

Rating	Symbol	Value	Unit
Peak Reverse Blocking Voltage, Note 1 ($T_J = 105^{\circ}\text{C}$)	V_{RRM}	50	Volts
*Peak Forward Blocking Voltage, Note 1 ($T_C = 105^{\circ}\text{C}$)	V_{DRM}	300 400 500 600 700 800	Volts
Repetitive Peak On-State Current ($PW = 3 \mu\text{s}$, Duty Cycle = 0.6%, $T_C = 85^{\circ}\text{C}$)	I_{TRM}	100	Amps
Continuous On-State Current ($T_C = 65^{\circ}\text{C}$)	I_T	5	Amps
Current Application Rate, Note 2	di/dt	5000	A/ μs
Peak Forward Gate Power	P_{GFM}	20	Watts
Average Forward Gate Power	$P_{GF(AV)}$	1	Watt
Peak Forward Gate Current	I_{GFM}	5	Amps
Peak Gate Voltage — Forward Reverse, Note 3	V_{GFM} V_{GRM}	10 10	Volts
Operating Junction Temperature Range Blocking State Conducting State	T_J	-65 to $+105$ -65 to $+200$	$^{\circ}\text{C}$
Storage Temperature Range	T_{stg}	-65 to $+200$	$^{\circ}\text{C}$
Stud Torque	—	15	in. lb.

*Indicates JEDEC Registered Data.

- Notes: 1. Characterized for unilateral applications where reverse blocking capability is not important. Higher voltage units available upon request. V_{DRM} and V_{RRM} may be applied as a continuous dc voltage for zero or negative gate voltage but positive gate voltage must not be applied concurrently with a negative potential on the anode. When checking blocking capability, do not permit the applied voltage to exceed the rated voltage.
2. Minimum Gate Trigger Pulse: $I_G = 200$ mA, $PW = 1 \mu\text{s}$, $t_r = 20$ ns.
3. Do not reverse bias gate during forward conduction if anode current exceeds 10 amperes.

Designers Data for "Worst Case" Conditions — The Designers Data Sheets permit the design of most circuits entirely from the information presented. Limit curves — representing boundaries on device characteristics — are given to facilitate "worst case" design.



T-25-15

THERMAL CHARACTERISTICS

Characteristic	Symbol	Max	Unit
*Thermal Resistance, Junction to Case	$R_{\theta JC}$	3	$^{\circ}C/W$

ELECTRICAL CHARACTERISTICS ($T_C = 25^{\circ}C$ unless otherwise noted.)

Characteristic	Fig. No.	Symbol	Min	Max	Unit
*Peak Forward or Reverse Blocking Current (Rated V_{DRM} or V_{RRM} , gate open) $T_C = 105^{\circ}C$	17	I_{DRM}, I_{RRM}	—	2	mA
Gate Trigger Current (Continuous dc) (Anode Voltage = 7 Vdc, $R_L = 100$ ohms, $T_C = 25^{\circ}C$) *(Anode Voltage = 7 Vdc, $R_L = 100$ ohms, $T_C = -65^{\circ}C$)	14	I_{GT}	— —	50 100	mA
Gate Trigger Voltage (Continuous dc) *(Anode Voltage = rated V_{DRM} , $R_L = 100$ ohms, $T_C = 105^{\circ}C$) (Anode Voltage = 7 Vdc, $R_L = 100$ ohms, $T_C = 25^{\circ}C$) *(Anode Voltage = 7 Vdc, $R_L = 100$ ohms, $T_C = -65^{\circ}C$)	12	V_{GT}	0.2 — —	— 1.5 2	Volts
*Holding Current (Anode Voltage = 7 Vdc, gate open, $T_C = 105^{\circ}C$)	18	I_H	3	—	mA
*Forward "On" Voltage ($I_{TM} = 5$ Adc, PW = 1 ms max, Duty cycle $\leq 1\%$)	8	V_{TM}	2.6	—	Volts
*Dynamic Forward "On" Voltage (0.5 μs after 50% decay point on dynamic forward voltage waveform) Forward Current: 30 A pulse Gate Pulse: at 200 mA, PW = 1 μs , $t_r = 20$ ns	7	V_{TM}	—	25	Volts
*Turn-On Time $I_{TM} = 30$ A Delay Time Rise Time	1, 9 1, 11	t_d t_r	— — — —	200 200 150 130 100	ns
*Pulse Turn-Off Time Test Conditions: PFN discharge; Forward Current = 30 A pulse; Reverse Current = 5 A, $T_C = 85^{\circ}C$, $dv/dt = 250$ V/ μs to Rated V_{DRM} ; Reverse anode voltage during turn-off interval = 0 V; Reverse gate bias during turn-off interval = 6 V.	2, 13	t_q	—	20	μs
*Forward Voltage Application Rate (Linear Rise of Voltage) ($T_C = 105^{\circ}C$, gate open, $V_D =$ Rated V_{DRM})	16	dv/dt	250	—	V/ μs

*JEDEC Registered Data.

3

T-25-15

TEST CIRCUITS

FIGURE 1 - TURN-ON TIME

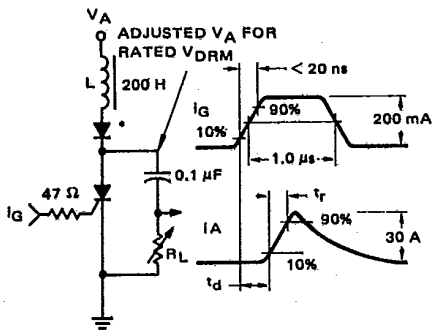

*Two 1N4937 fast-recovery diodes in series each shunted by a 180 kΩ resistor.

FIGURE 2 - TURN-OFF TIME

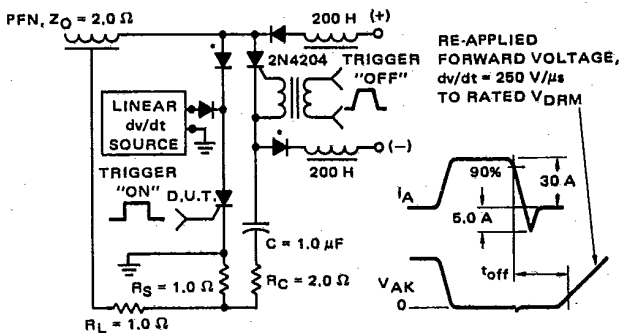
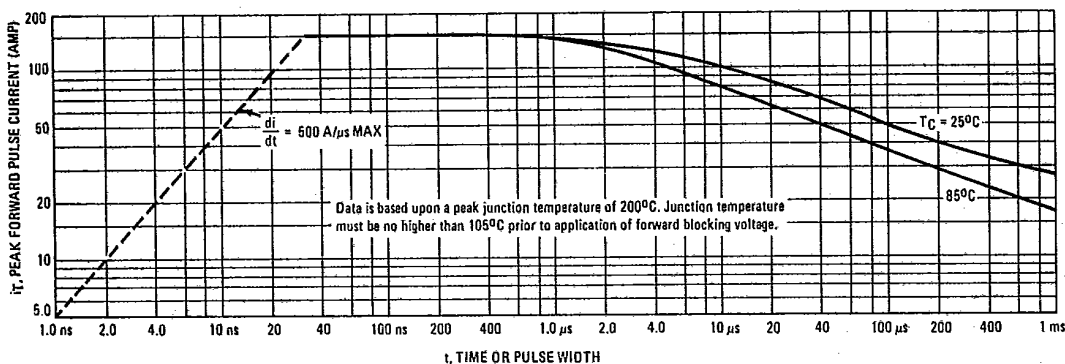

FIGURE 3 - MAXIMUM ALLOWABLE FORWARD PULSE CURRENT



3

FIGURE 4 - DERATING USING NO SWITCHING LOSSES

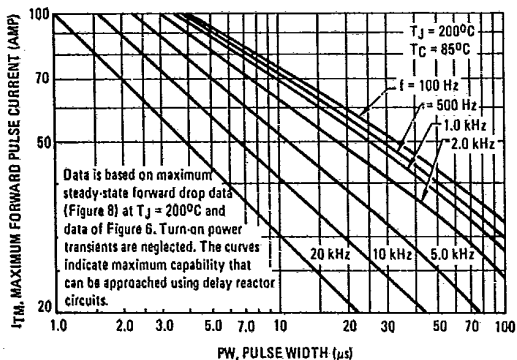
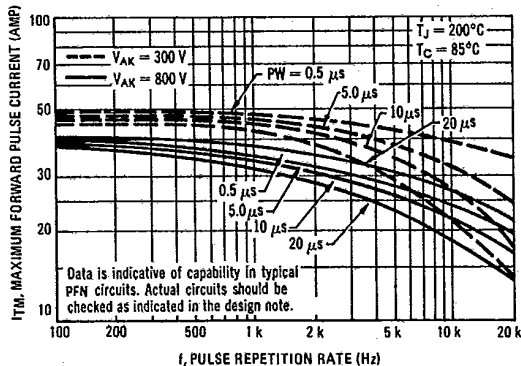
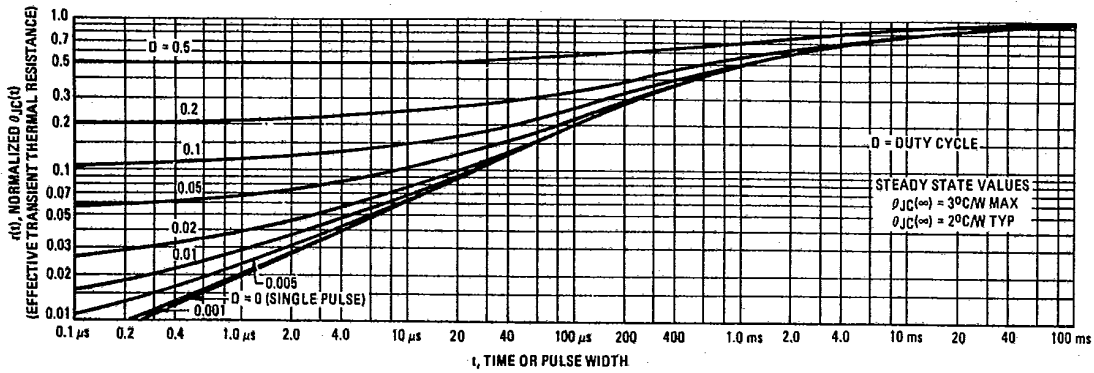

FIGURE 5 - DERATING USING TYPICAL SWITCHING LOSSES



T-25-15

FIGURE 6 - NORMALIZED EFFECTIVE TRANSIENT THERMAL RESISTANCE



FORWARD "ON" VOLTAGE DATA

FIGURE 7 - TYPICAL DYNAMIC FORWARD "ON" VOLTAGE

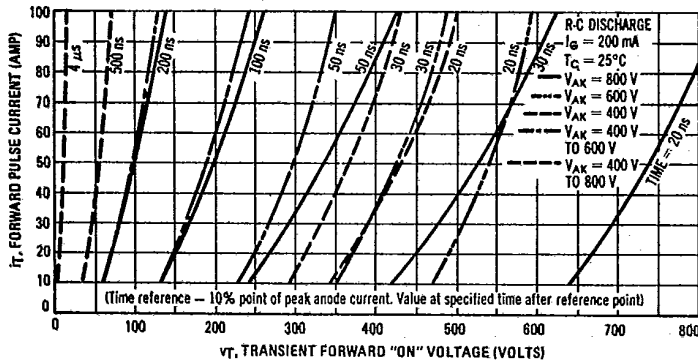
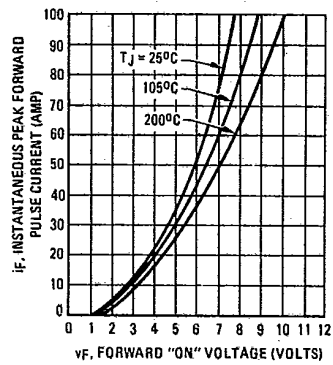

FIGURE 8 - MAXIMUM STEADY-STATE



3

DESIGN NOTE CONTINUED

$$\Delta T(t_4) = \left[1000 \left(0.0205 + (1 - 5.25 \cdot 10^{-3}) 0.27 + 6.25 \cdot 10^{-3} - 0.27 \right) + 700 \left((1 - 7.75 \cdot 10^{-3}) 0.27 + 7.75 \cdot 10^{-3} - 0.27 \right) \right] 3 = 93.51^{\circ}\text{C}$$

$$\Delta T(t_5) = \left[1000 \left(0.032 + (1 - 5.25 \cdot 10^{-3}) 0.27 + 5.25 \cdot 10^{-3} - 0.27 - 0.0205 \right) + 700 \left(0.025 + (1 - 7.75 \cdot 10^{-3}) 0.27 + 7.75 \cdot 10^{-3} - 0.27 \right) \right] 3 = 105.6^{\circ}\text{C}$$

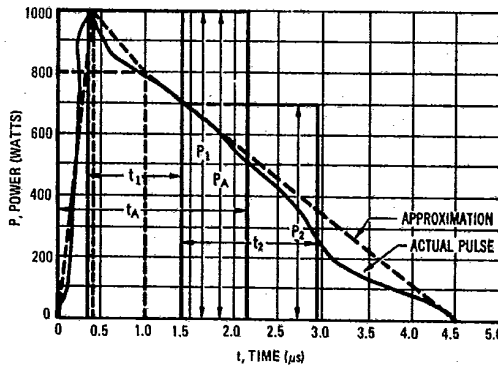
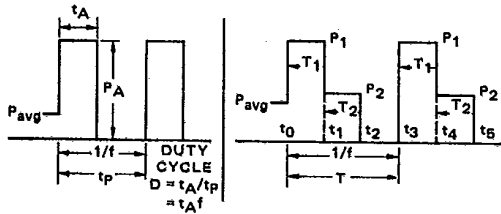

FIGURE A - SIMPLE MODEL

FIGURE B - MORE ACCURATE MODEL

FIGURE C - AN ACTUAL TRANSIENT POWER PULSE

T-25-15

SWITCHING CHARACTERISTICS

FIGURE 9 - DELAY TIME

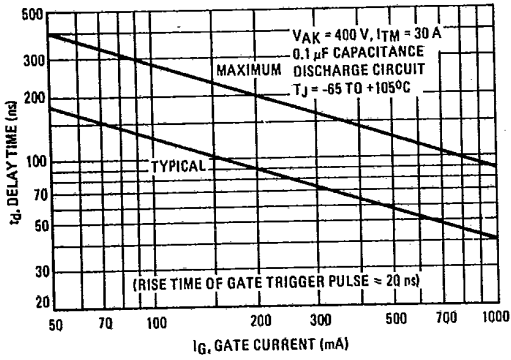

TRIGGERING CHARACTERISTICS

FIGURE 10 - TYPICAL PULSE TRIGGER CHARGE/CURRENT

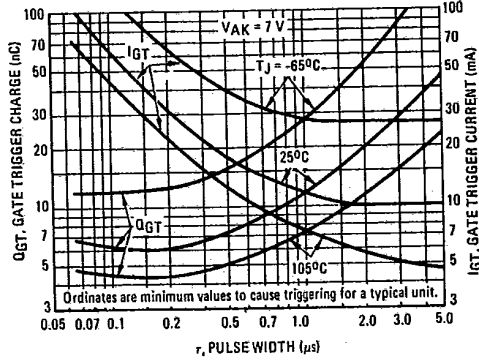

FIGURE 11 - CURRENT RISE TIME

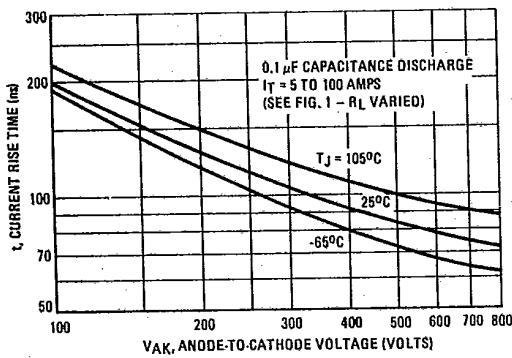
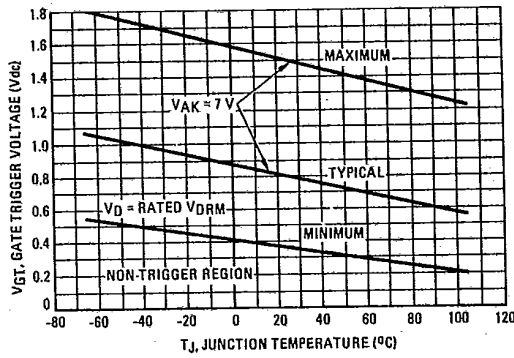

FIGURE 12 - DC GATE TRIGGER VOLTAGE



3

FIGURE 13 - TYPICAL TURN-OFF TIME

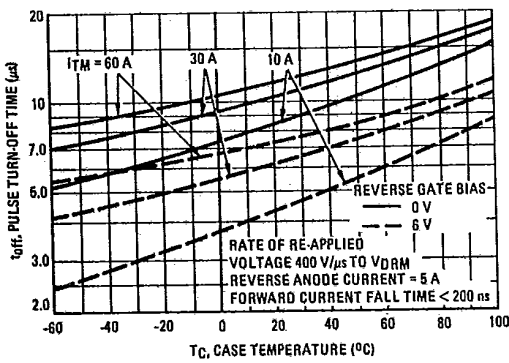
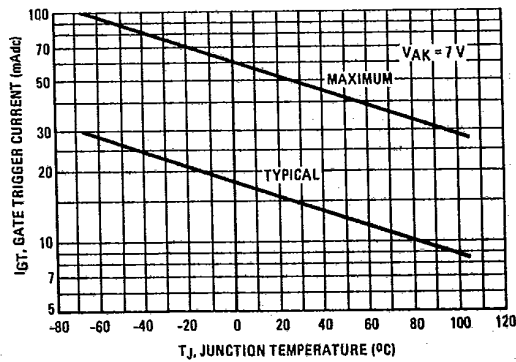
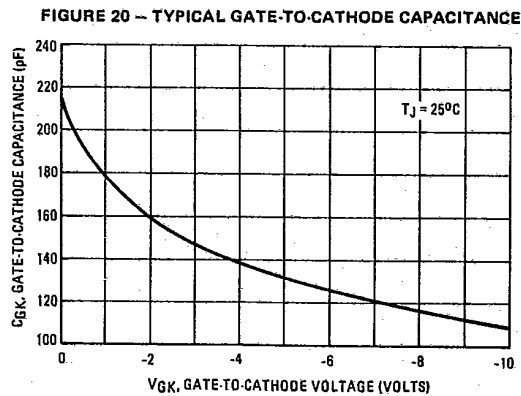
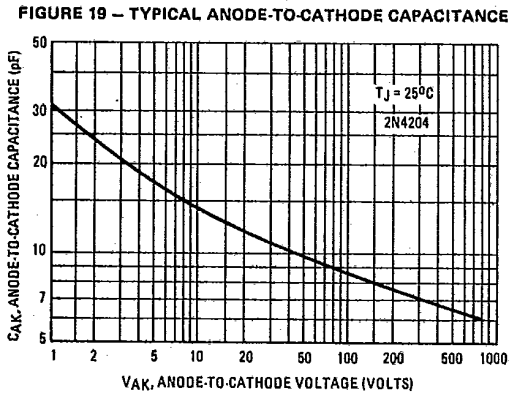
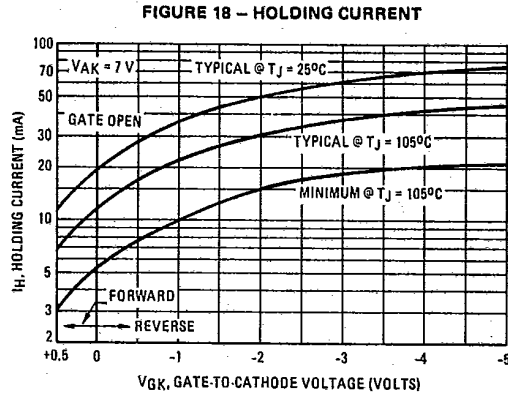
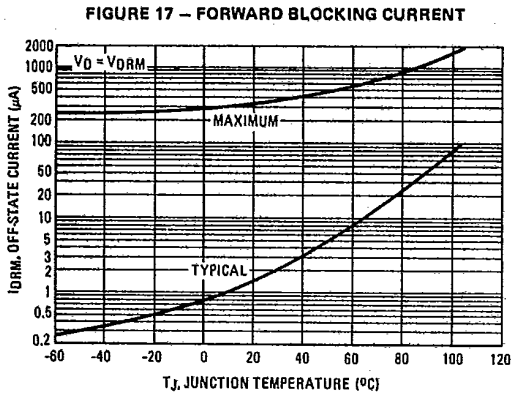
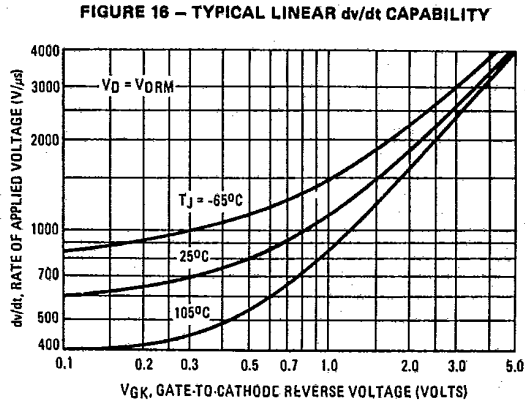
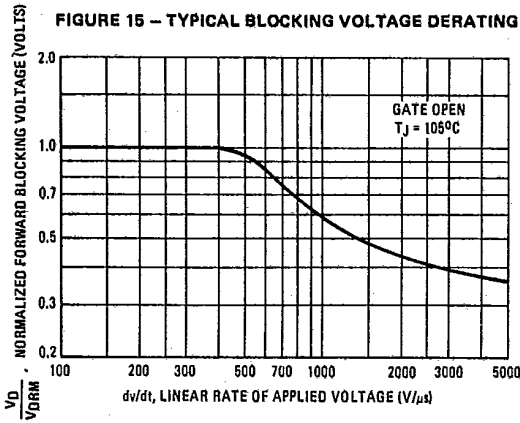

FIGURE 14 - DC GATE TRIGGER CURRENT



2N4199 thru 2N4204

T-25-15



3