

2029A

PNP Epitaxial Planar
Silicon Composite Transistor

T-29-27

Differential Amp Applications

©957C

Applications

- Differential amp, current mirror, temperature compensator.

Features

- Excellent in thermal equilibrium and suited for use in differential amp applications.
- Matched pair capability.

Absolute Maximum Ratings at Ta=25°C

Parameter	Symbol	Value	Unit
Collector to Base Voltage	V _{CB0}	-55	V
Collector to Emitter Voltage	V _{CE0}	-50	V
Emitter to Base Voltage	V _{EBO}	-5	V
Collector Current	I _C	-150	mA
Peak Collector Current	i _{cp}	-300	mA
Collector Dissipation	P _C	200	mW
Total Dissipation	P _T	400	mW
Junction Temperature	T _J	150	°C
Storage Temperature	T _{stg}	-55 to +150	°C

Electrical Characteristics at Ta=25°C

Parameter	Symbol	Test Conditions	min	typ	max	Unit
Collector Cutoff Current	I _{CB0}	V _{CB} = -35V, I _E = 0			-0.1	uA
Emitter Cutoff Current	I _{EBO}	V _{EB} = -4V, I _C = 0			-0.1	uA
DC Current Gain	h _{FE}	V _{CE} = -6V, I _C = -1mA	100*		560*	
DC Current Gain Ratio	h _{FE(small/large)}	V _{CE} = -6V, I _C = -1mA	0.85	0.98		

Continued on next page.

*: The 2SA1237 is classified by h_{FE} (small) as follows:

100 E	200	160 F	320	280 G	560
-------	-----	-------	-----	-------	-----

The 2SA1237 is provided with a surface mounted package.

Case Outline 2029A
(unit:mm)

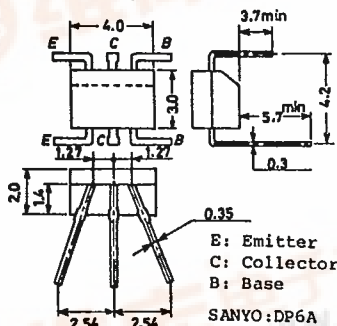

Case Outline 2030A
(unit:mm)

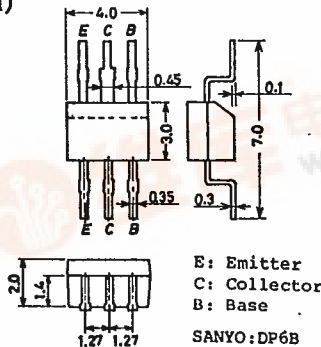

2SA1237

T-29-27

Continued from preceding page.

			min	typ	max	unit
Base to Emitter Voltage Drop	$V_{BE(large-small)}$	$V_{CE}=-6V, I_C=-1mA$		1.0	10	mV
Collector to Emitter Saturation Voltage	$V_{CE(sat)}$	$I_C=-50mA, I_B=-5mA$			-0.5	V
Gain-Bandwidth Product	f_T	$V_{CE}=-6V, I_C=-1mA$		100		MHz
Output Capacitance	c_{ob}	$V_{CB}=-10V, f=1MHz$		5.0		pF
Collector to Base Breakdown Voltage	$V_{(BR)CBO}$	$I_C=-10\mu A, I_E=0$	-55			V
Collector to Emitter Breakdown Voltage	$V_{(BR)CEO}$	$I_C=-1mA, R_{BE}=\infty$	-50			V
Emitter to Base Breakdown Voltage	$V_{(BR)EBO}$	$I_E=-10\mu A, I_C=0$	-5			V

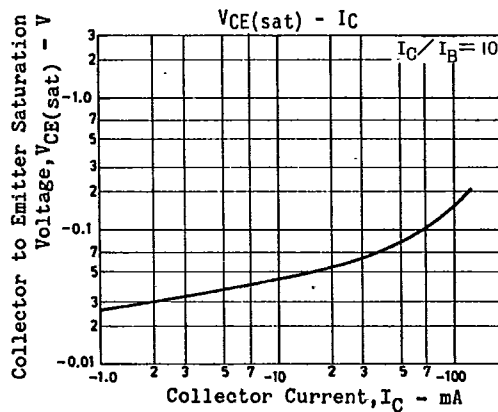
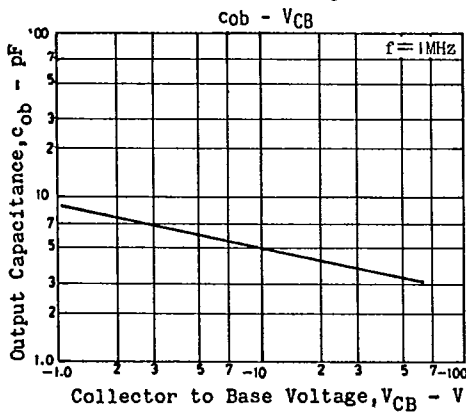
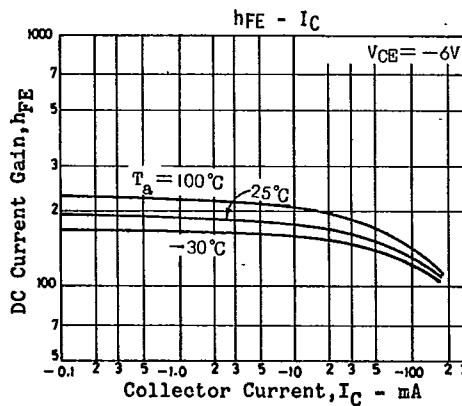
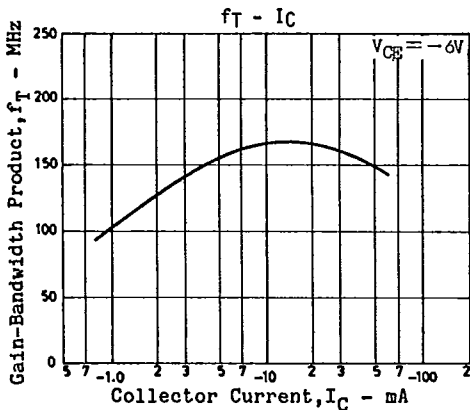
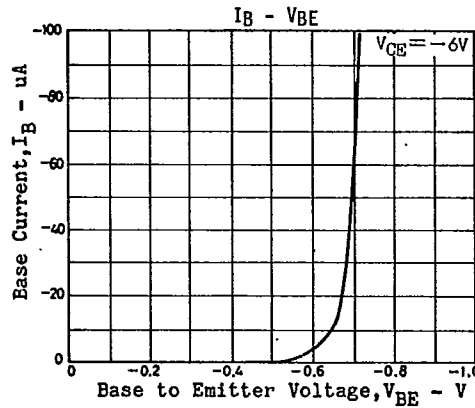
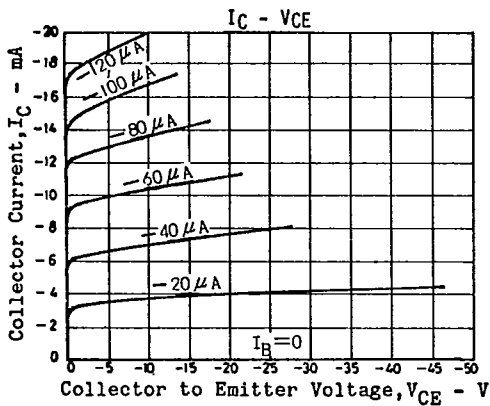

2SA1237

T-29-27

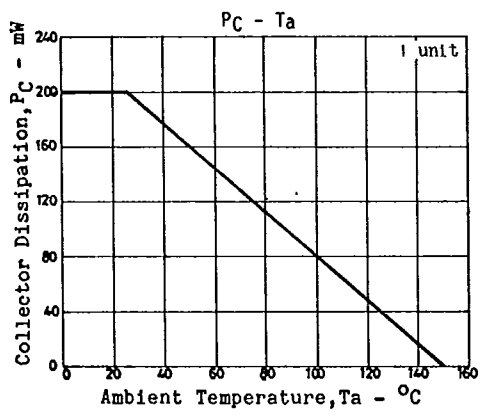

T-91-20

CASE OUTLINES OF LEAD FORMED SMALL SIGNAL TRANSISTORS

- All of Sanyo lead formed small signal transistor case outlines are illustrated below.
- All dimensions are in mm, and dimensions which are not followed by min. or max. are represented by typical values.
- No marking is indicated.

Case Outline-[2003A] unit: mm

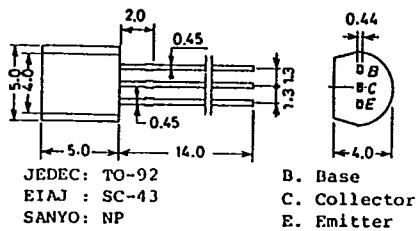

Case Outline-[2019A] unit: mm

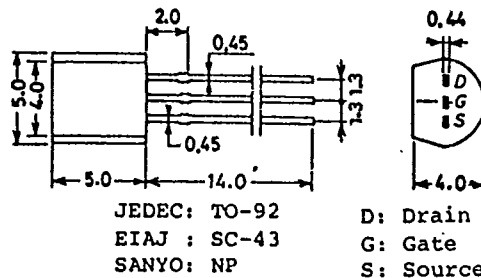

Case Outline-[2004A] unit: mm

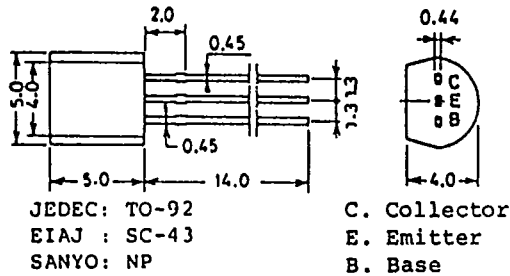

Case Outline-[2025] unit: mm

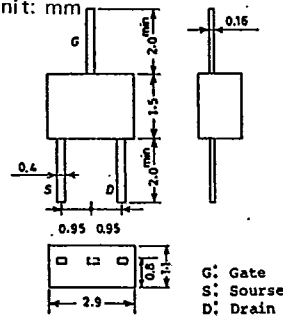

Case Outline-[2005A] unit: mm

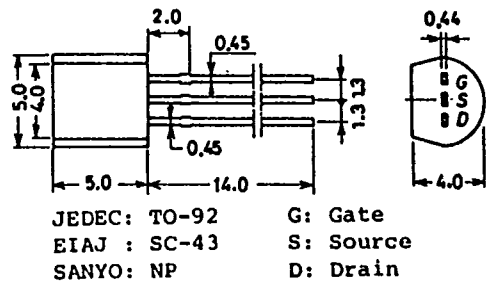

Case Outline-[2026] unit: mm

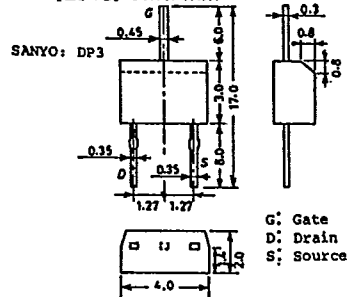

Case Outline-[2006A] unit: mm

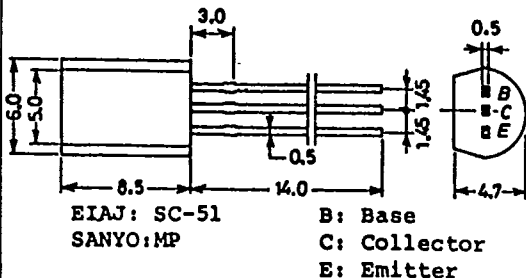

Case Outline-[2027A] unit: mm

