

SANYO SEMICONDUCTOR CORP 32E D 7997076 0008830 7



T-29-11

2029A PNP Epitaxial Planar Silicon Transistor

Differential Amp Applications

©977C

Applications

- . Differential amp, current mirror.

Features

- . Excellent in thermal equilibrium and suited for use in first-stage differential amp.
- . Low noise.
- . Matched pair capability.

Absolute Maximum Ratings at Ta=25°C

Parameter	Symbol	Value	Unit
Collector to Base Voltage	V _{CB0}	-130	V
Collector to Emitter Voltage	V _{CE0}	-120	V
Emitter to Base Voltage	V _{EB0}	-5	V
Collector Current	I _C	-50	mA
Peak Collector Current	i _{cp}	-100	mA
Collector Dissipation	P _C	200	mW
Total Dissipation	P _T	400	mW
Junction Temperature	T _J	150	°C
Storage Temperature	T _{stg}	-55 to +150	°C



Electrical Characteristics at Ta=25°C

Parameter	Symbol	Test Conditions	min	typ	max	unit
Collector Cutoff Current	I _{CB0}	V _{CB} =-80V, I _E =0			-0.1	uA
Emitter Cutoff Current	I _{EB0}	V _{EB} =-4V, I _C =0			-0.1	uA
DC Current Gain	h _{FE}	V _{CE} =-6V, I _C =-1mA	160*		560*	
DC Current Gain Ratio	h _{FE} (small/large)	V _{CE} =-6V, I _C =-1mA	0.85	0.98		

Continued on next page.

*:The 2SA1240 is classified by h_{FE} (small) as follows:

160 F	320	280 G	560
-------	-----	-------	-----

The 2SA1240 is provided with a surface mounted package.

Case Outline 2029A (unit:mm)

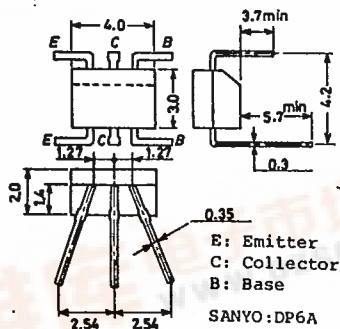

Case Outline 2030A (unit:mm)

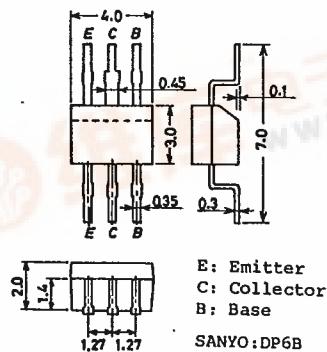

2SA1240

T-29-11

Continued from preceding page.

			min	typ	max	unit
Base to Emitter Voltage Drop	$V_{BE(large-small)}$	$V_{CE}=-6V, I_C=-1mA$		1.0	10	mV
Collector to Emitter Saturation Voltage	$V_{CE(sat)}$	$I_C=-10mA, I_B=-1mA$			-0.5	V
Gain-Bandwidth Product	f_T	$V_{CE}=-6V, I_C=-1mA$		110		MHz
Output Capacitance	c_{ob}	$V_{CB}=-10V, f=1MHz$		2.0		pF
Collector to Base Breakdown Voltage	$V_{(BR)CBO}$	$I_C=-10uA, I_E=0$	-130			V
Collector to Emitter Breakdown Voltage	$V_{(BR)CEO}$	$I_C=-1mA, R_{BE}=\infty$	-120			V
Emitter to Base Breakdown Voltage	$V_{(BR)EBO}$	$I_E=-10uA, I_C=0$	-5			V
Noise Level	$V_{NO(ave)}$	$V_{CC}=30V, I_C=1mA, R_g=56kohm, V_G=77dB/1kHz$			35	mV
Noise Peak Level	$V_{NO(peak)}$	$V_{CC}=30V, I_C=1mA, R_g=56kohm, V_G=77dB/1kHz$			200	mV

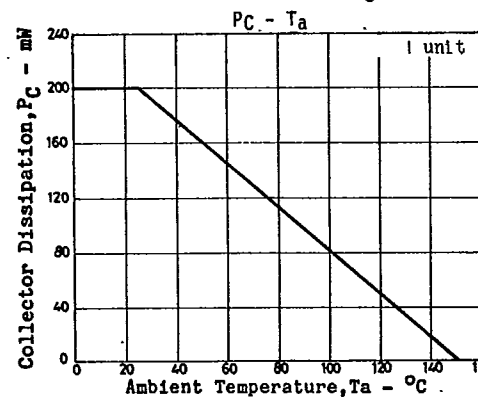
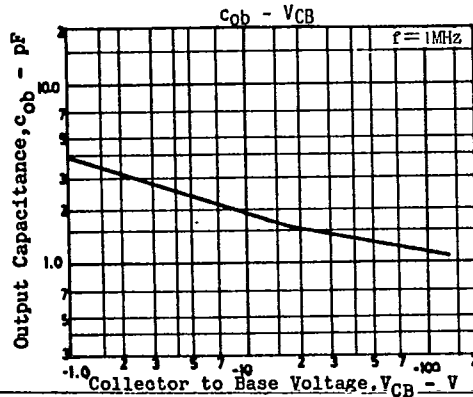
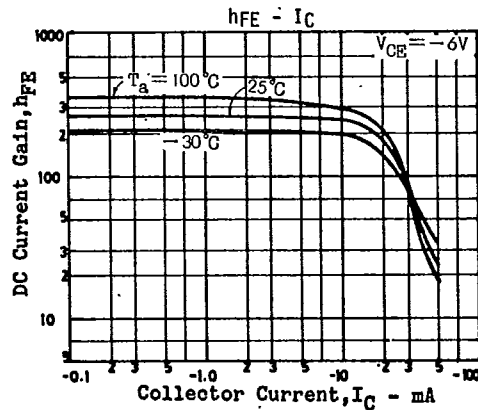
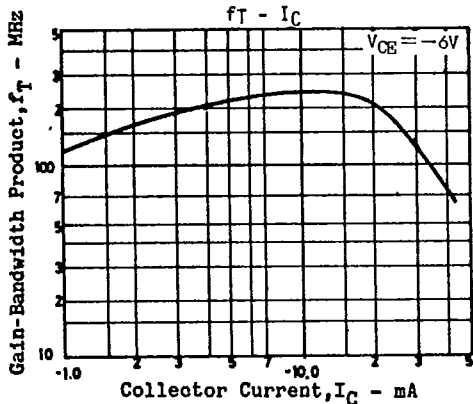
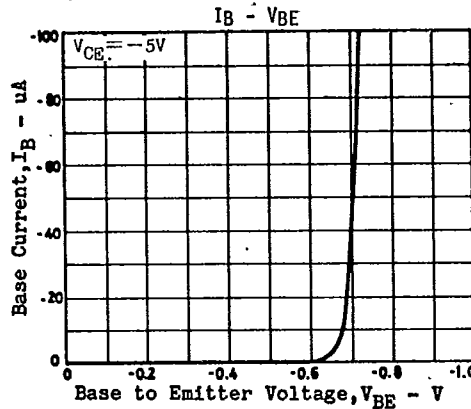
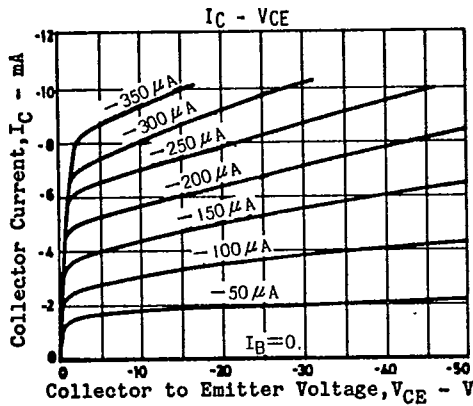

2SA1240

T-29-11

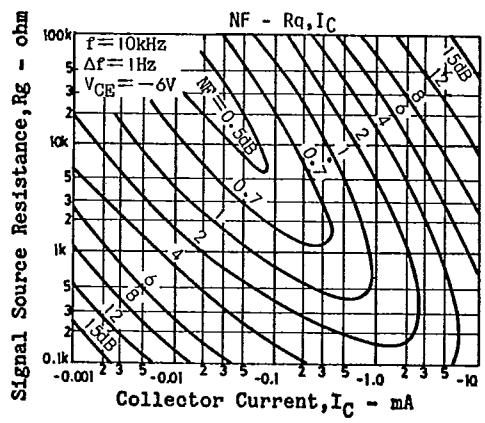
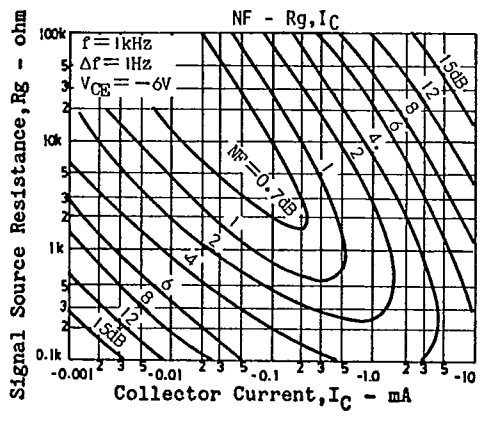
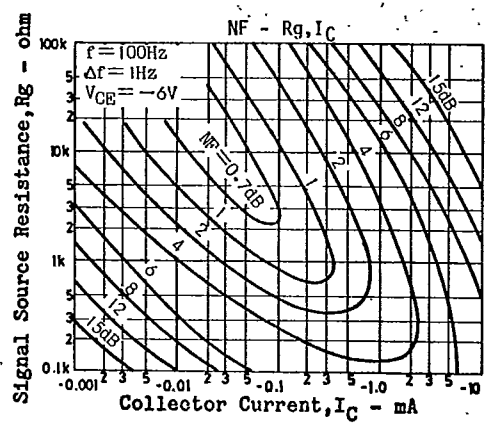
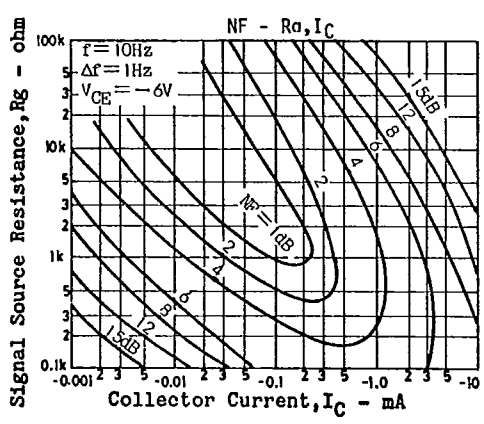

T-91-20

CASE OUTLINES OF LEAD FORMED SMALL SIGNAL TRANSISTORS

- All of Sanyo lead formed small signal transistor case outlines are illustrated below.
- All dimensions are in mm, and dimensions which are not followed by min. or max. are represented by typical values.
- No marking is indicated.

Case Outline-[2003A] unit: mm

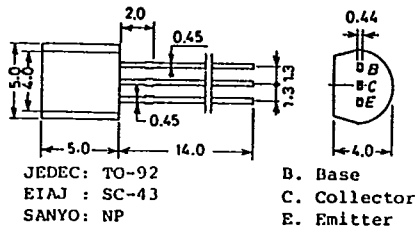

Case Outline-[2019A] unit: mm

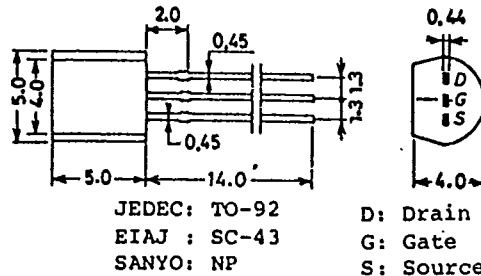

Case Outline-[2004A] unit: mm

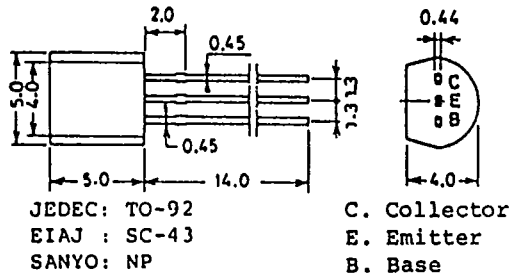

Case Outline-[2025] unit: mm

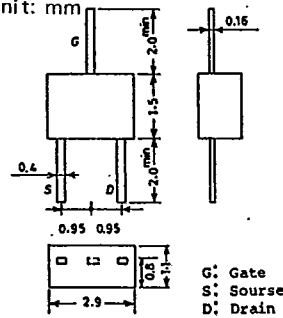

Case Outline-[2005A] unit: mm

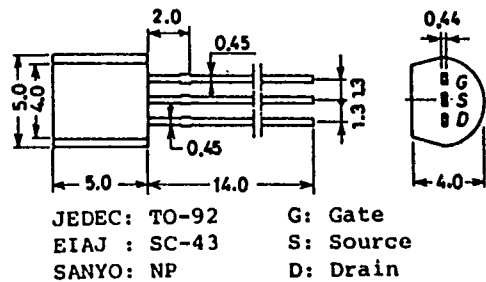

Case Outline-[2026] unit: mm

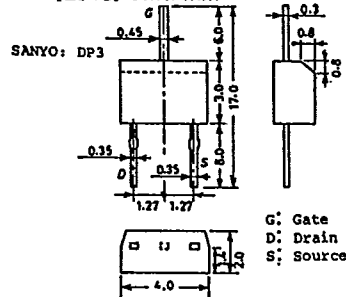

Case Outline-[2006A] unit: mm

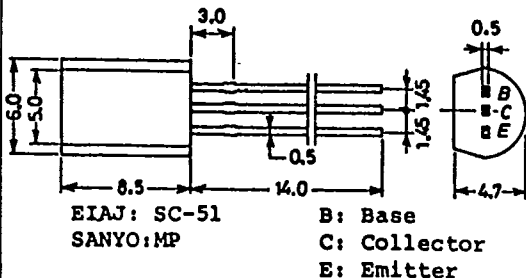

Case Outline-[2027A] unit: mm

