

SANYO	No.2086B	2SB1204/2SD1804
	PNP/NPN Epitaxial Planar Silicon Transistors	
High-Current Switching Applications		

Applications

- Relay drivers, high-speed inverters, converters, and other general high-current switching applications

Features

- Low collector-to-emitter saturation voltage
- High current and high f_T
- Excellent linearity of h_{FE}
- Fast switching time
- Small and slim package making it easy to make 2SB1204/2SD1804-applied sets smaller

() : 2SB1204

Absolute Maximum Ratings at $T_a = 25^\circ C$

			unit
Collector to Base Voltage	V_{CB0}	(-)	60 V
Collector to Emitter Voltage	V_{CE0}	(-)	50 V
Emitter to Base Voltage	V_{EB0}	(-)	6 V
Collector Current	I_C	(-)	8 A
Collector Current(Pulse)	I_{CP}	(-)	12 A
Collector Dissipation	P_C		1 W
		$T_c = 25^\circ C$	20 W
Junction Temperature	T_j		150 $^\circ C$
Storage Temperature	T_{stg}		-55 to +150 $^\circ C$

Electrical Characteristics at $T_a = 25^\circ C$

			min	typ	max	unit
Collector Cutoff Current	I_{CB0}	$V_{CB} = (-)40V, I_E = 0$			(-)	1 μA
Emitter Cutoff Current	I_{EB0}	$V_{EB} = (-)4V, I_C = 0$			(-)	1 μA
DC Current Gain	$h_{FE}(1)$	$V_{CE} = (-)2V, I_C = (-)0.5A$	70*		400*	
	$h_{FE}(2)$	$V_{CE} = (-)2V, I_C = (-)6A$	35			
Gain-Bandwidth Product	f_T	$V_{CE} = (-)5V, I_C = (-)1A$		180		MHz
				(130)		
Output Capacitance	C_{ob}	$V_{CB} = (-)10V, f = 1MHz$		(95)65		pF

Continued on next page.

* : The 2SB1204/2SD1804 are classified by 0.5A h_{FE} as follows :

70	Q	140	100	R	200	140	S	280	200	T	400
----	---	-----	-----	---	-----	-----	---	-----	-----	---	-----

Package Dimensions 2045B

(unit : mm)

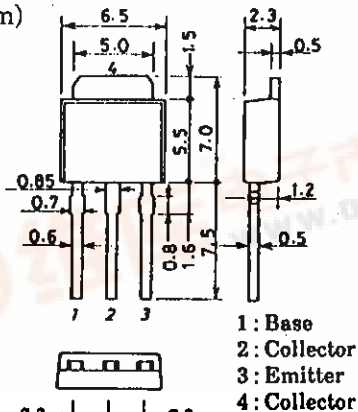

Package Dimensions 2044B

(unit : mm)

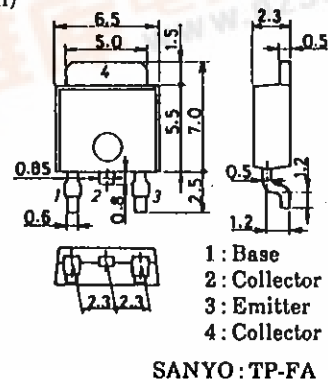

2SB1204/2SD1804

Continued from preceding page.

			min	typ	max	unit
C-E Saturation Voltage	$V_{CE(sat)}$	$I_C = (-)4A, I_B = (-)0.2A$		200	400	mV
B-E Saturation Voltage	$V_{BE(sat)}$	$I_C = (-)4A, I_B = (-)0.2A$		(-250)	(-500)	V
C-B Breakdown Voltage	$V_{(BR)CBO}$	$I_C = (-)10\mu A, I_E = 0$	(-)	60		V
C-E Breakdown Voltage	$V_{(BR)CEO}$	$I_C = (-)1mA, R_{BE} = \infty$	(-)	50		V
E-B Breakdown Voltage	$V_{(BR)EBO}$	$I_E = (-)10\mu A, I_C = 0$	(-)	6		V
Turn-on Time	t_{on}	See specified Test Circuit.		(50)		ns
Storage Time	t_{stg}	"		(450)500		ns
Fall Time	t_f	"		20		ns

Switching Time Test Circuit

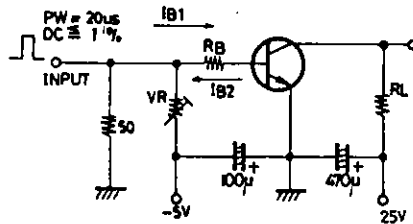

$I_C = 10 \text{ I}_B = -10 \text{ I}_B = 4A$
(For PNP, the polarity is reversed.)

Unit (Resistance : Ω , Capacitance : F)

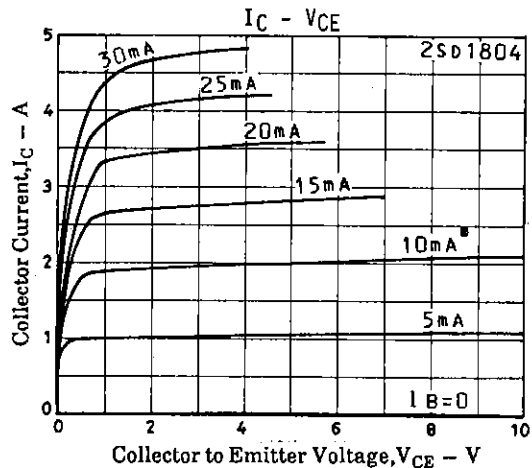
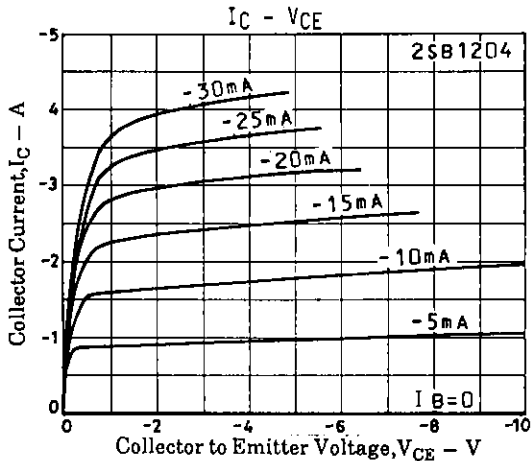
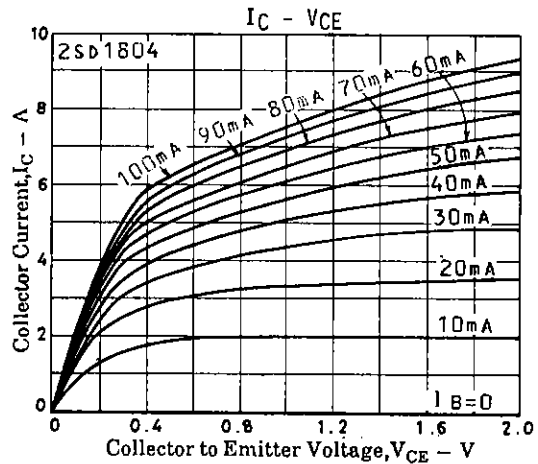
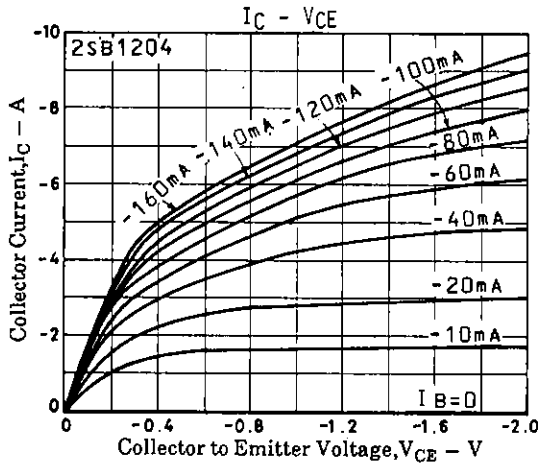

2SB1204/2SD1804

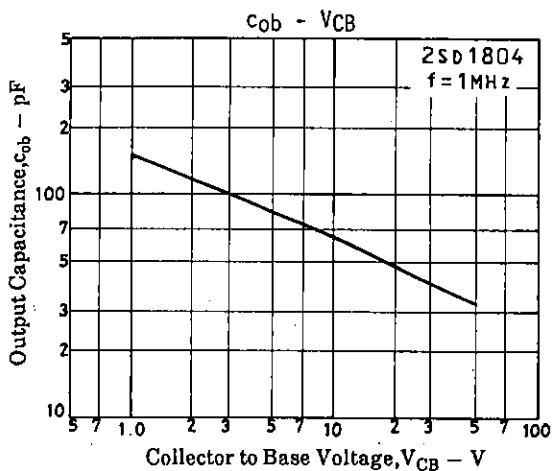
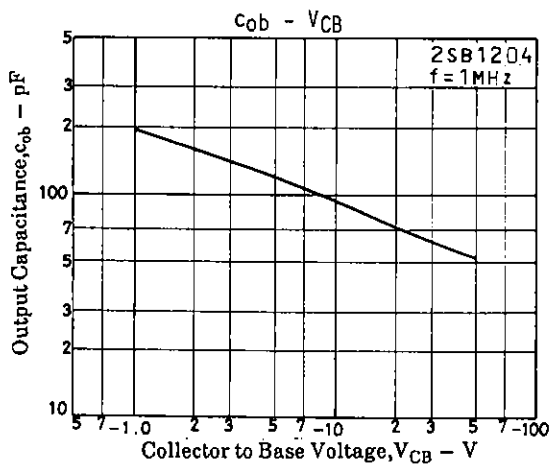
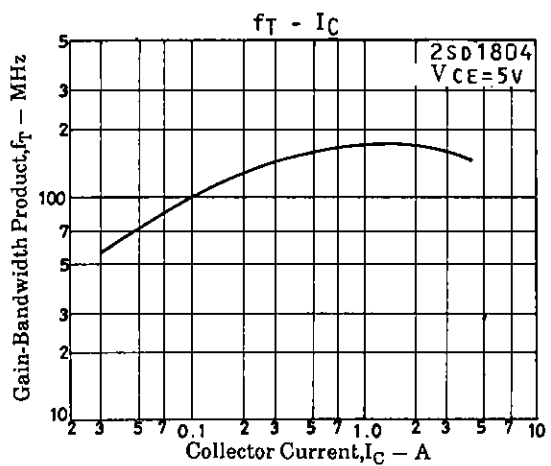
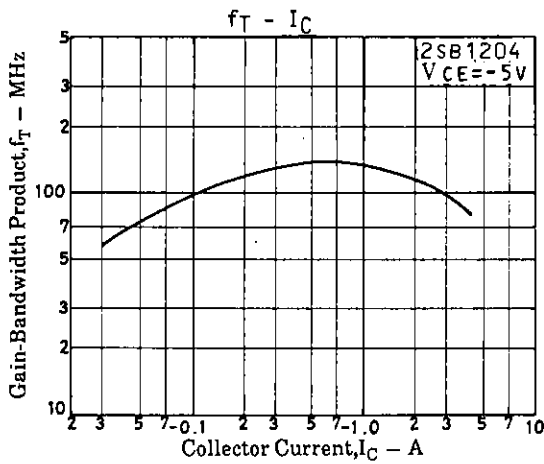
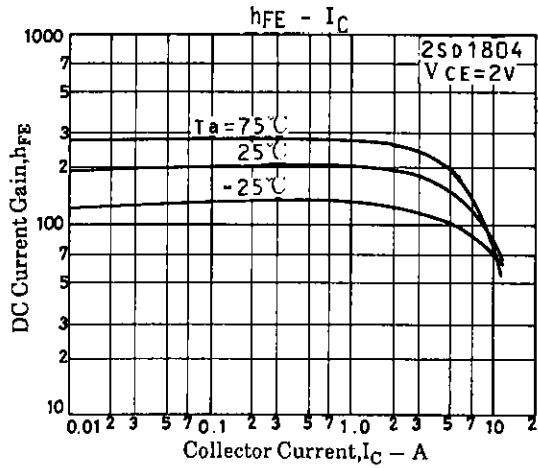
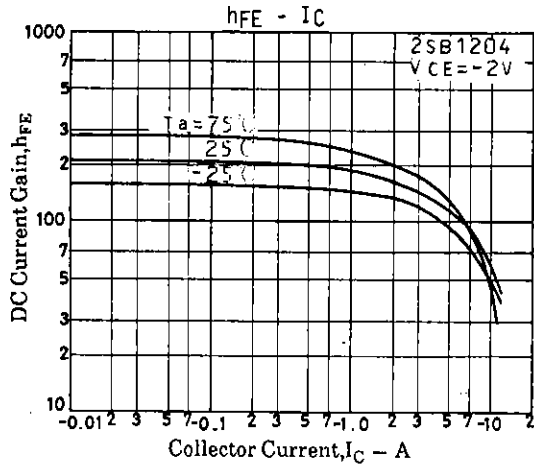
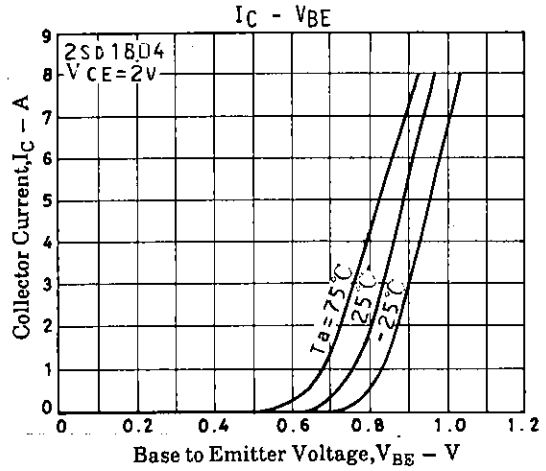
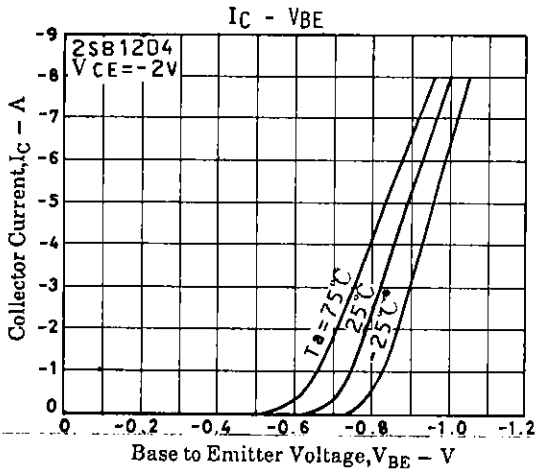

2SB1204/2SD1804

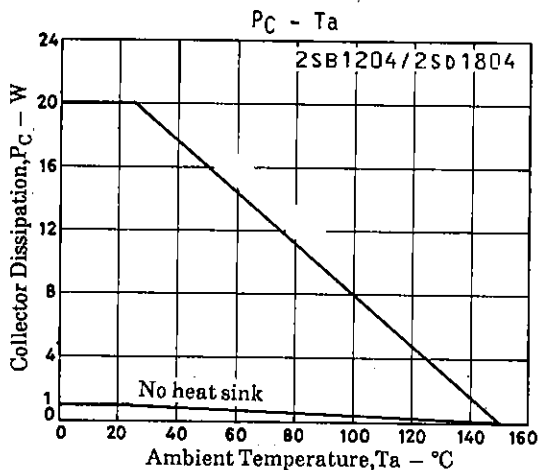
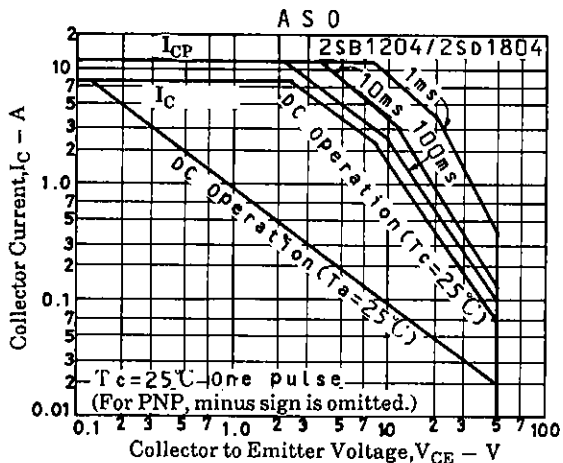
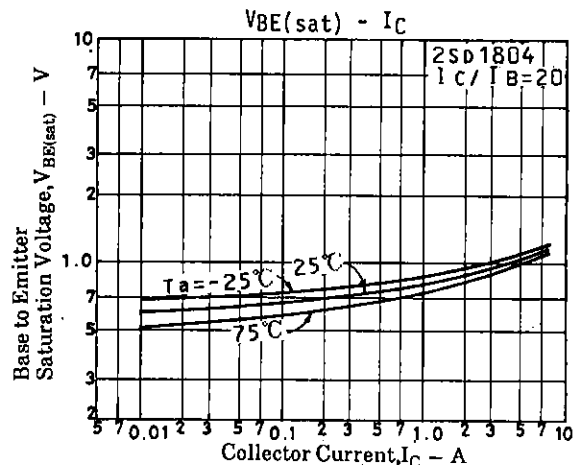
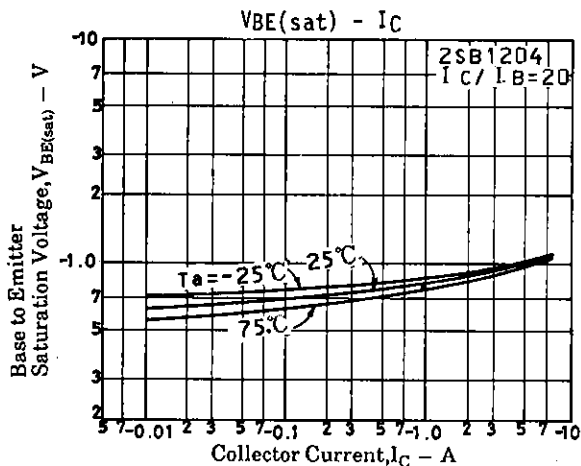
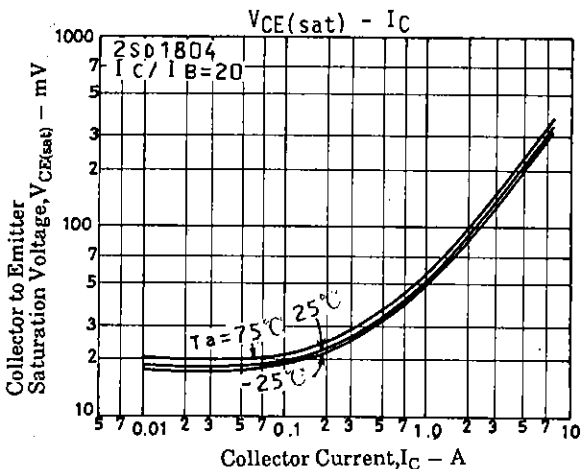
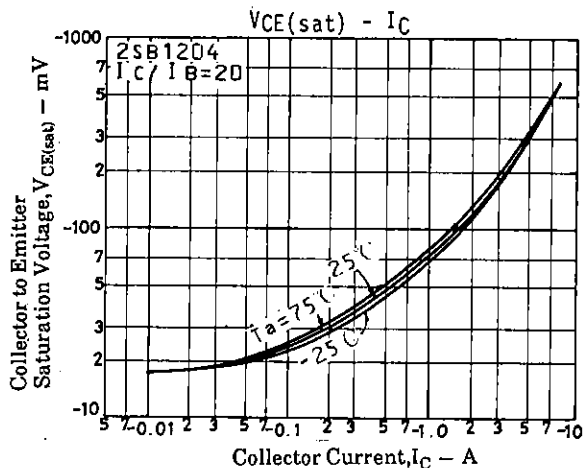

■ No products described or contained herein are intended for use in surgical implants, life-support systems, aerospace equipment, nuclear power control systems, vehicles, disaster/crime-prevention equipment and the like, the failure of which may directly or indirectly cause injury, death or property loss.

■ Anyone purchasing any products described or contained herein for an above-mentioned use shall:

- ① Accept full responsibility and indemnify and defend SANYO ELECTRIC CO., LTD., its affiliates, subsidiaries and distributors and all their officers and employees, jointly and severally, against any and all claims and litigation and all damages, cost and expenses associated with such use;
- ② Not impose any responsibility for any fault or negligence which may be cited in any such claim or litigation on SANYO ELECTRIC CO., LTD., its affiliates, subsidiaries and distributors or any of their officers and employees jointly or severally.

■ Information (including circuit diagrams and circuit parameters) herein is for example only; it is not guaranteed for volume production. SANYO believes information herein is accurate and reliable, but no guarantees are made or implied regarding its use or any infringements of intellectual property rights or other rights of third parties.